

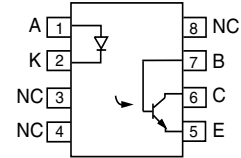

Optocoupler, Phototransistor Output, Low Input Current, With Base Connection

Features

- High Current Transfer Ratio
- Isolation Test Voltage, 3000 V_{RMS}
- Industry Standard SOIC-8 Surface Mountable Package
- Compatible with Dual Wave, Vapor Phase and IR Reflow Soldering

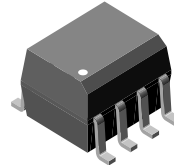

1179083

Agency Approvals

- UL - File No. E52744 System Code Y
- DIN EN 60747-5-2(VDE0884)
DIN EN 60747-5-5 pending
Available with Option 1

The high CTR at low input current is designed for low power consumption requirements such as CMOS microprocessor interfaces.

Description

The IL215AT/ IL216AT/ IL217AT are optically coupled pairs with a Gallium Arsenide infrared LED and a silicon NPN phototransistor. Signal information, including a DC level, can be transmitted by the device while maintaining a high degree of electrical isolation between input and output. The IL215AT/ IL216AT/ IL217AT comes in a standard SOIC-8 small outline package for surface mounting which makes it ideally suited for high density applications with limited space. In addition to eliminating through hole requirements, this package conforms to standards for surface mounted devices.

Order Information

Part	Remarks
IL215AT	CTR > 20 %, SOIC-8
IL216AT	CTR > 50 %, SOIC-8
IL217AT	CTR > 100 %, SOIC-8

Available only on Tape and Reel
(Conforms to EIA Standard RS481A)

For additional information on the available options refer to Option Information.

Absolute Maximum Ratings

T_{amb} = 25 °C, unless otherwise specified

Stresses in excess of the absolute Maximum Ratings can cause permanent damage to the device. Functional operation of the device is not implied at these or any other conditions in excess of those given in the operational sections of this document. Exposure to absolute Maximum Rating for extended periods of the time can adversely affect reliability.

Input

Parameter	Test condition	Symbol	Value	Unit
Peak reverse voltage		V _R	6.0	V
Forward continuous current		I _F	60	mA
Power dissipation		P _{diss}	90	mW
Derate linearly from 25 °C			1.2	mW/°C

Output

Parameter	Test condition	Symbol	Value	Unit
Collector-emitter breakdown voltage		BV_{CEO}	30	V
Emitter-collector breakdown voltage		BV_{ECO}	7.0	V
Collector-base breakdown voltage		BV_{CBO}	70	V
$I_{CMAX DC}$		$I_{CMAX DC}$	50	mA
I_{CMAX}	$t < 1.0 \text{ ms}$	I_{CMAX}	100	mA
Power dissipation		P_{diss}	150	mW
Derate linearly from 25 °C			2.0	mW/°C

Coupler

Parameter	Test condition	Symbol	Value	Unit
Total package dissipation	LED + Detector	P_{tot}	240	mW
Derate linearly from 25 °C			3.2	mW/°C
Storage temperature		T_{stg}	- 55 to + 150	°C
Operating temperature		T_{amb}	- 55 to + 100	°C
Soldering time at 260 °C			10	sec.

Electrical Characteristics

$T_{amb} = 25 \text{ °C}$, unless otherwise specified

Minimum and maximum values are testing requirements. Typical values are characteristics of the device and are the result of engineering evaluation. Typical values are for information only and are not part of the testing requirements.

Input

Parameter	Test condition	Symbol	Min	Typ.	Max	Unit
Forward voltage	$I_F = 1.0 \text{ mA}$	V_F		1.0	1.5	V
Reverse current	$V_R = 6.0 \text{ V}$	I_R		0.1	100	μA
Capacitance	$V_R = 0$	C_O		13		pF

Output

Parameter	Test condition	Symbol	Min	Typ.	Max	Unit
Collector-emitter breakdown voltage	$I_C = 10 \text{ }\mu\text{A}$	BV_{CEO}	30			V
Emitter-collector breakdown voltage	$I_E = 10 \text{ }\mu\text{A}$	BV_{ECO}	7.0			V
Dark current collector-emitter	$V_{CE} = 10 \text{ V}, I_F = 0$	I_{CEO}		5.0	50	nA
Collector-emitter capacitance	$V_{CE} = 0$	C_{CE}		10		pF

Coupler

Parameter	Test condition	Symbol	Min	Typ.	Max	Unit
Saturation voltage, collector-emitter	$I_F = 1.0 \text{ mA}, I_C = 0.1 \text{ mA}$	V_{CEsat}			0.4	V
Isolation test voltage	1 sec.	V_{ISO}	3000			V_{RMS}
Capacitance (input-output)		C_{IO}		0.5		pF
Resistance input to output		R_{IO}		100		$G\Omega$

Current Transfer Ratio

Parameter	Test condition	Part	Symbol	Min	Typ.	Max	Unit
DC Current Transfer Ratio	$I_F = 1.0 \text{ mA}$, $V_{CE} = 5.0 \text{ V}$	IL215AT	CTR_{DC}	20	50		%
		IL216AT	CTR_{DC}	50	80		%
		IL217AT	CTR_{DC}	100	130		%

Switching Characteristics

Parameter	Test condition	Symbol	Min	Typ.	Max	Unit
Switching time	$I_C = 2.0 \text{ mA}$, $R_L = 100 \Omega$, $V_{CC} = 10 \text{ V}$	t_{on} , t_{off}		3.0		μs

Typical Characteristics ($T_{amb} = 25 \text{ }^\circ\text{C}$ unless otherwise specified)

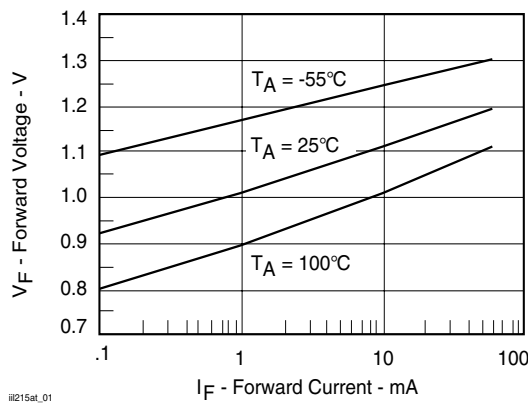

#215at_01

Fig. 1 Forward Voltage vs. Forward Current

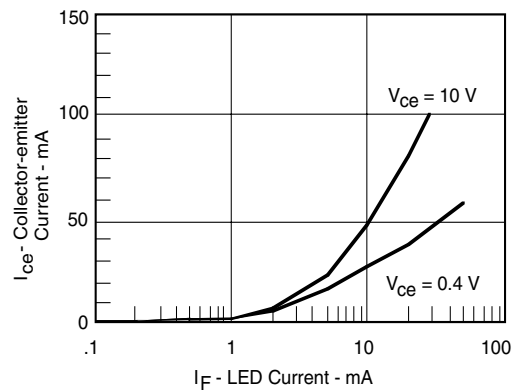

#215at_03

Fig. 3 Collector-Emitter Current vs. LED Current

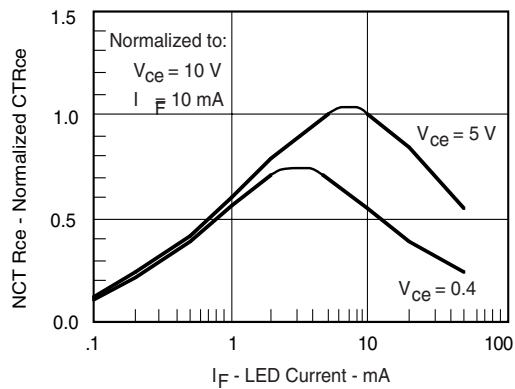

#215at_02

Fig. 2 Normalized Non-saturated and Saturated CTR_{CE} vs. LED Current

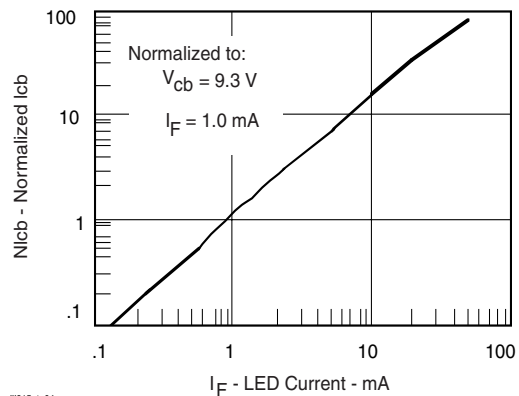

#215at_04

Fig. 4 Normalized Collector-Base Photocurrent vs. LED Current

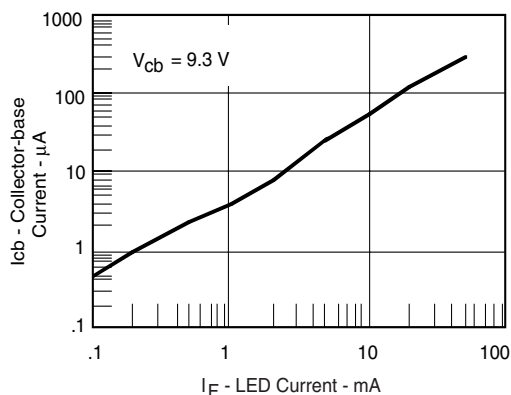

#215at_05

Fig. 5 Collector-Base Photocurrent vs. LED Current

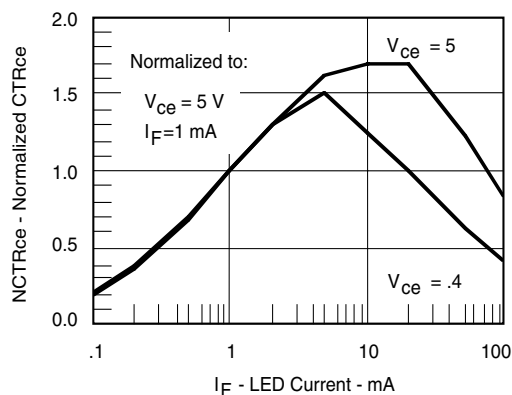

#215at_08

Fig. 8 Normalized Non-Saturated and Saturated CTR_{CE} vs. LED Current

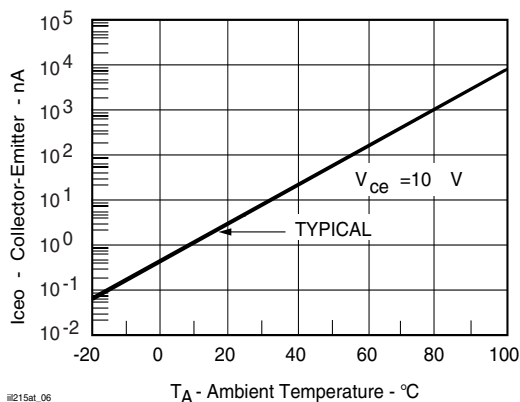

#215at_06

Fig. 6 Collector-Emitter Leakage Current vs. Temp.

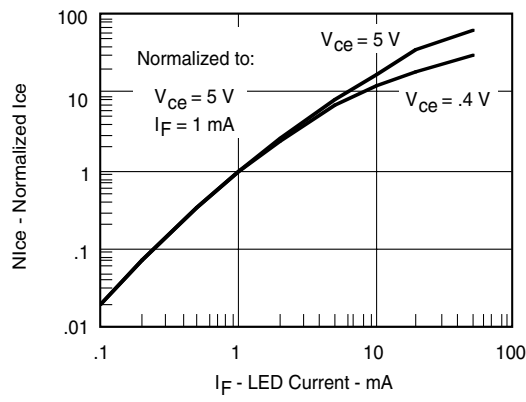

#215at_09

Fig. 9 Normalized Non-Saturated and Saturated Collector-Emitter Current vs. LED Current

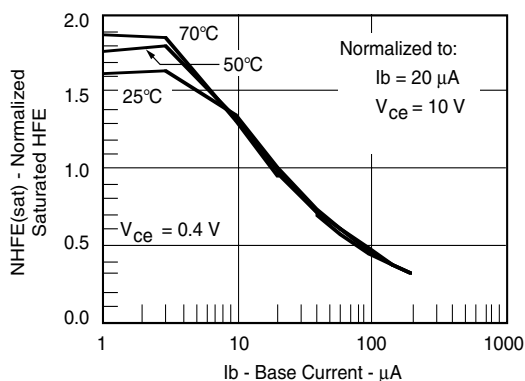

#215at_07

Fig. 7 Normalized Saturated HFE vs. Base Current and Temperature

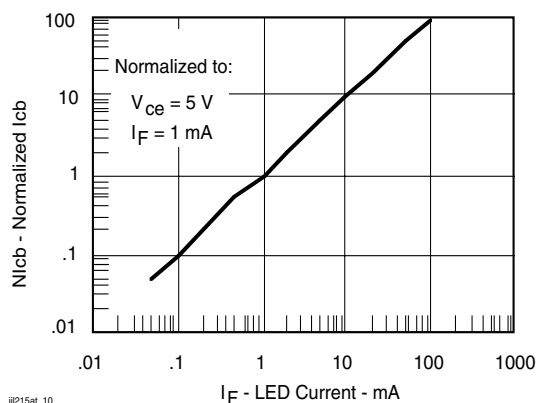

#215at_10

Fig. 10 Normalized Collector-Base Photocurrent vs. LED Current

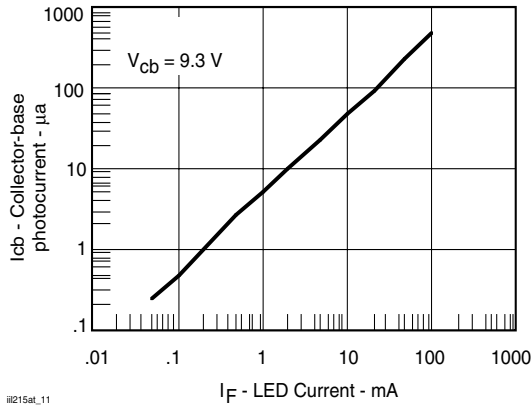

Fig. 11 Collector-Base Photocurrent vs. LED Current

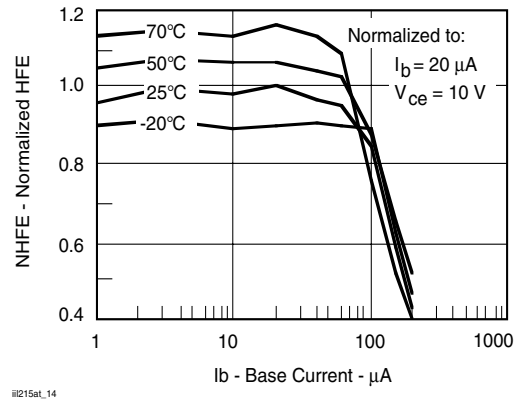

Fig. 14 Normalized Non-saturated HFE vs. Base Current and Temperature

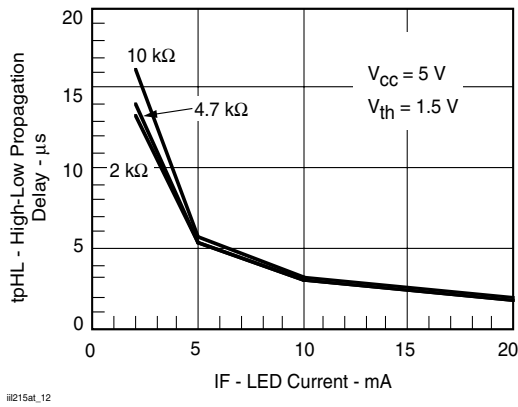

Fig. 12 High to Low Propagation Delay vs. LED Current and Load Resistor

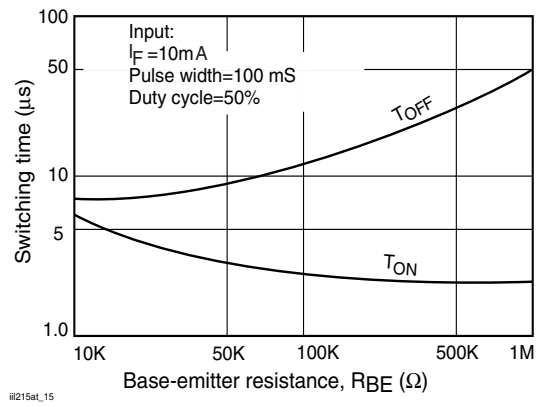

Fig. 15 Typical Switching Characteristics vs. Base Resistance (Saturated Operation)

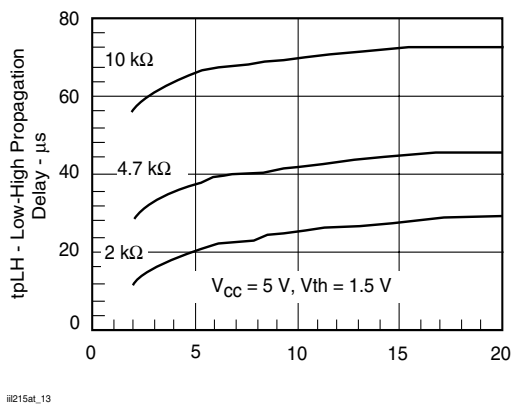

Fig. 13 Low to High Propagation Delay vs. LED Current and Load Resistor

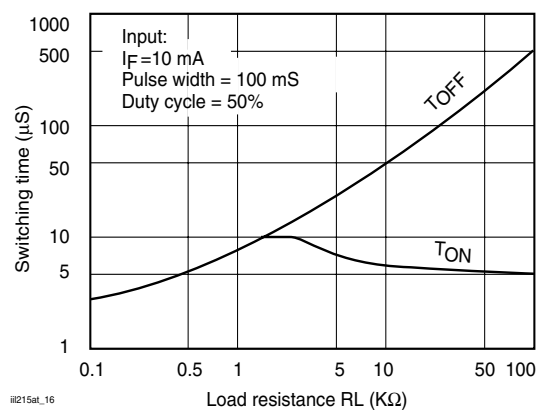
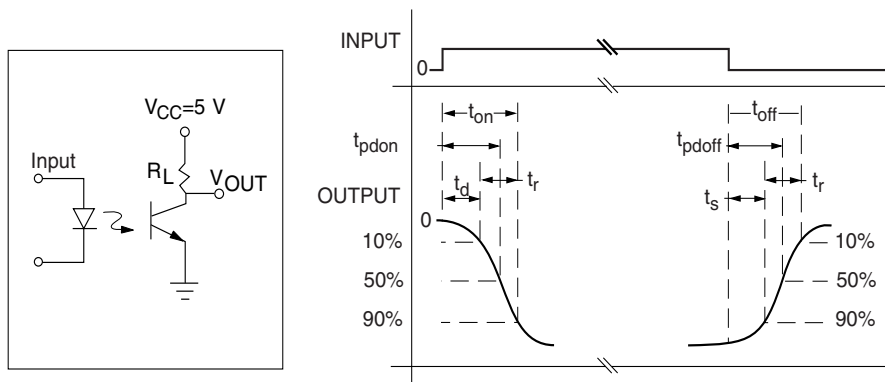

Fig. 16 Typical Switching Times vs. Load Resistance

IL215AT/ IL216AT/ IL217AT



Vishay Semiconductors



il215at_17

Fig. 17 Switching Time Test Schematic and Waveform

Package Dimensions in Inches (mm)

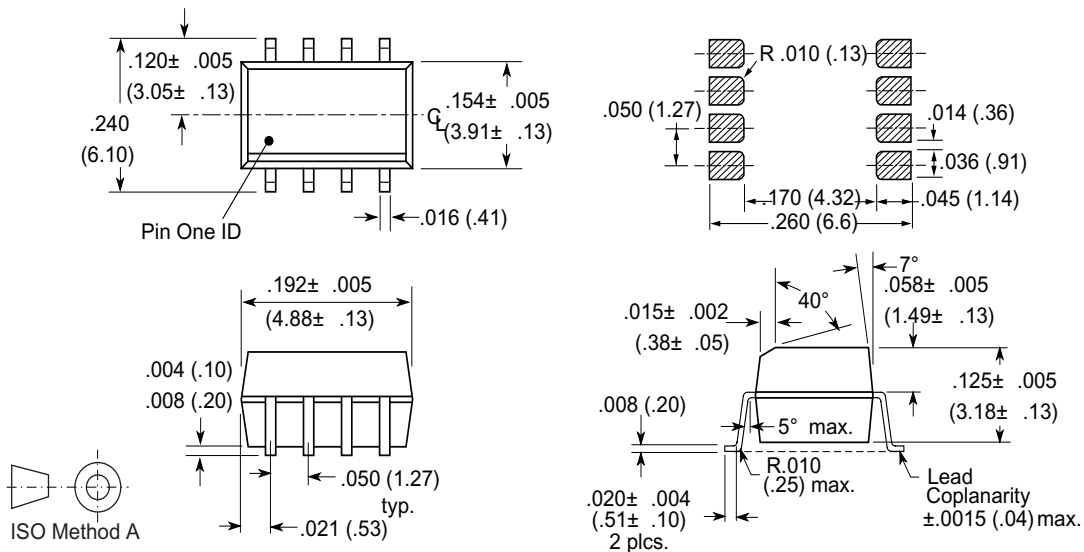

i178003



Ozone Depleting Substances Policy Statement

It is the policy of **Vishay Semiconductor GmbH** to

1. Meet all present and future national and international statutory requirements.
2. Regularly and continuously improve the performance of our products, processes, distribution and operating systems with respect to their impact on the health and safety of our employees and the public, as well as their impact on the environment.

It is particular concern to control or eliminate releases of those substances into the atmosphere which are known as ozone depleting substances (ODSs).

The Montreal Protocol (1987) and its London Amendments (1990) intend to severely restrict the use of ODSs and forbid their use within the next ten years. Various national and international initiatives are pressing for an earlier ban on these substances.

Vishay Semiconductor GmbH has been able to use its policy of continuous improvements to eliminate the use of ODSs listed in the following documents.

1. Annex A, B and list of transitional substances of the Montreal Protocol and the London Amendments respectively
2. Class I and II ozone depleting substances in the Clean Air Act Amendments of 1990 by the Environmental Protection Agency (EPA) in the USA
3. Council Decision 88/540/EEC and 91/690/EEC Annex A, B and C (transitional substances) respectively.

Vishay Semiconductor GmbH can certify that our semiconductors are not manufactured with ozone depleting substances and do not contain such substances.

**We reserve the right to make changes to improve technical design
and may do so without further notice.**

Parameters can vary in different applications. All operating parameters must be validated for each customer application by the customer. Should the buyer use Vishay Semiconductors products for any unintended or unauthorized application, the buyer shall indemnify Vishay Semiconductors against all claims, costs, damages, and expenses, arising out of, directly or indirectly, any claim of personal damage, injury or death associated with such unintended or unauthorized use.

Vishay Semiconductor GmbH, P.O.B. 3535, D-74025 Heilbronn, Germany
Telephone: 49 (0)7131 67 2831, Fax number: 49 (0)7131 67 2423

This datasheet has been download from:

www.datasheetcatalog.com

Datasheets for electronics components.