

NEW

OMRON

XS5 Smartclick

Round Water-resistant Connectors

XW3D Smartclick

Connector Terminal Boxes

Simple, Twist-and-Click Connection.
Meet the Next-generation
M12 Smartclick Connector!

New Assembly Connectors Added to the Lineup.
Many Sensors for Easier Application.



realizing

The simple, Smartclick XS5 Connector is completely compatible with conventional screw-type M12 connectors.

Patent Pending

A simple twist is all it takes to connect the Smartclick XS5, making it an ideal next-generation M12 connector. It's also easy to introduce to existing facilities because it takes only 1/4 the time of ordinary wiring processes, and it's compatible with conventional, screw-type connectors.

XS5

The Smartclick connector solves the problems of previous screw-type connectors.

1

Problem It's troublesome to screw the connectors together.

Solution It's a twist-and-click connection.

An innovative new lock structure makes connection extremely simple. The lock mechanism is internal, so it will no longer become jammed by sputtered fluids or dust. Also, the use of a movable lock bolt makes it possible to connect the Smartclick XS5 to a screw-type M12 connector.

All combinations are connectable.

	XS5 Smartclick Plug Connector	M12 plug connector
XS5 Smartclick Socket Connector	Twist-and-click connection	Screw connection
M12 socket connector	Screw connection	Screw connection

2

Problem There's nothing to tell you that it's connected.

Solution The Smartclick XS5 "clicks" to tell you it's connected.

A positive clicking feel tells you for sure that the Connector is securely locked.



3

Problem It's difficult to keep track of locking torque values.

Solution Locking is done with approximately 1/8th of a turn.

The Smartclick XS5 has the industry's shortest locking rotation of 1/8th of a turn. There's no need to keep track of locking torque, and this greatly reduces time and effort when wiring.

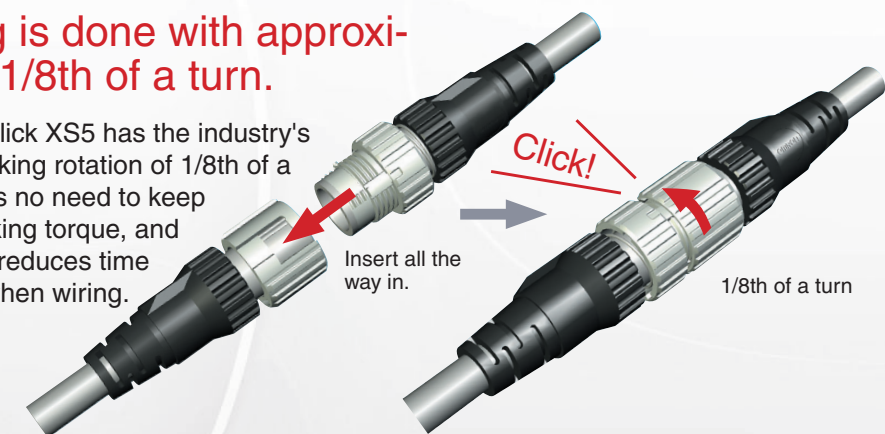

4

Problem The connection sometimes vibrates loose.

Solution A bayonet lock mechanism is used.

By using a bayonet mechanism, which is a common locking method, the Smartclick XS5 eliminates any concerns about loosening.

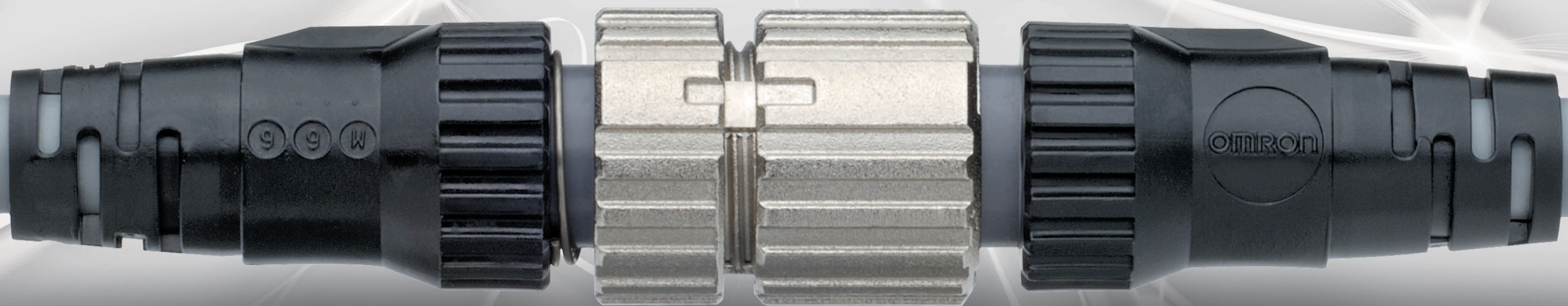
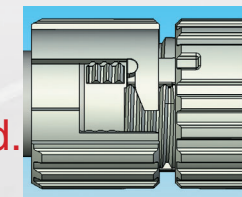

Round Water-resistant Connectors

XS5

Round Water-resistive Smartclick Connectors That Reduce Installation Work

- A newly developed lock mechanism that is compatible with round M12 connectors.
- Simply insert the Connectors, then turn them approximately 1/8 of a turn to lock.
- A positive click indicates locking.
- Features the same degree of protection (IP67) as M12 connectors.
- A full line-up of models is planned.
- Connectors with Cables are UL approved.



Ratings and Specifications

Rated current	4 A
Rated voltage	250 VDC
Contact resistance (connector)	40 mΩ max. (20 mV max., 100 mA max.)
Insulation resistance	1,000 MΩ min. (at 500 VDC)
Dielectric strength (connector)	1,500 VAC for 1 min (leakage current: 1 mA max.)
Degree of protection	IP67 (IEC60529)
Insertion tolerance	50 times min.
Lock strength	Tensile: 100 N/15 s, Torsion: 1 N·m/15 s
Cable holding strength	100 N/15 s (for cable diameter of 6 mm)
Lock operating force	0.1 N·m to 0.25 N·m
Ambient operating temperature range	-25 to 70°C

Recommended Cables

Cable outer diameter (mm)	Core sizes		
	Crimping models	Soldering models	Screw-on models
8 mm 7 to 8 mm	Two types of contacts are available. 0.18 to 0.3 mm ² 0.5 to 0.75 mm ²	0.5 mm ² max.	0.18 to 0.75 mm ²
7 mm 6 to 8 mm			
6 mm 5 to 6 mm			
4 mm 4 to 5 mm			
3 mm 3 to 4 mm			

Materials and Finish

Item	Model	XS5F/H/W/R	XS5M/P	XS5C/G
Contacts	Materials	Phosphor bronze		Brass
	Finish	Nickel base, 0.4-μm gold plating		
Fixtures	Nickel-plated zinc alloy			
Pin block	PBT resin (UL94V-0)			
O-ring	Rubber			
Overmolding/Cover	Polyester elastomer		---	PBT resin (UL94V-0)
Cable	Standard cable	UL AWM2464, 6-mm dia. 4 cores × AWG20 (0.12/49)	---	---
	Vibration-proof robot cable	UL AWM2464, 6-mm dia. 4 cores × AWG20 (0.08/110)	---	---
	Oil-resistant polyurethane cable	6 dia. 4 cores × 0.5 mm ² (0.12/45)	---	---
Seal resin	---	Epoxy resin (UL94V-0)	---	---
Power supply wires	---	UL1007 AWG20	---	---

Connection Combinations

OMRON model no.		Smartclick Plug Connectors	M12 Plug Connectors
		XS5H, XS5G, XS5W (plug side), XS5R (plug side), XS5M	XS2H, XS2G, XS2W (plug side), XS2R (plug side), XS2M
Smartclick Socket Connectors	XS5F, XS5C, XS5W (socket side), XS5R (socket side), XS5P	⊗	○
M12 Socket Connectors	XS2F, XS2C, XS2W (socket side), XS2R (socket side), XS2P	○	○

⊗: Connected by Smartclick.
○: Connected by screwing.
Note: The XS□M and XS□P cannot mate with each other.

Smartclick is a registered trademark of the OMRON Corporation.

XS5W Smartclick

Connectors Connected to Cable, Socket and Plug on Cable Ends

<ul style="list-style-type: none"> ● Standard Cable ● Vibration-proof Robot Cable ● Oil-resistant Polyurethane Cable 	<p>XS5W-D42□-□81-A</p> <p>XS5W-D42□-□81-F</p> <p>XS5W-D42□-□81-P</p>
---	--

Dimensions

(Unit: mm)

Straight/straight

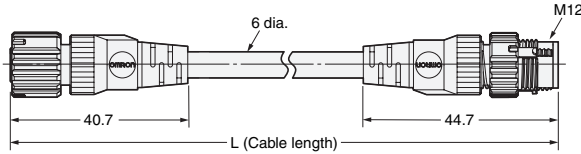

Angled/angled

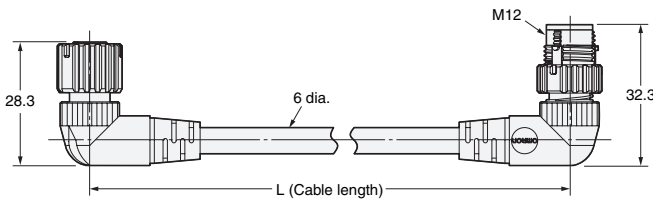

Straight/angled

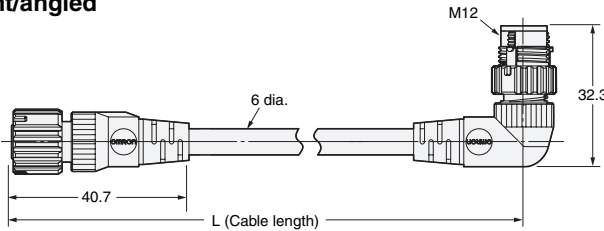

Angled/straight

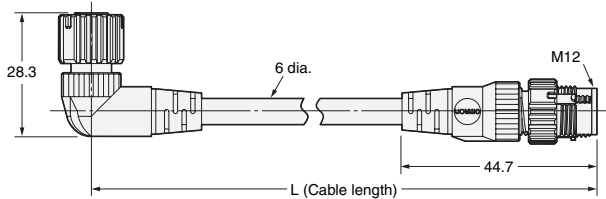

Wiring Diagram for 4 Cores

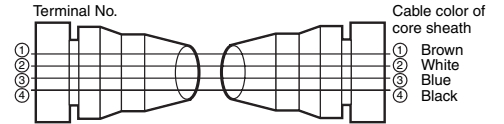

Note: The overmolding on the Standard Cable (XS5W-D42□-□81-A) and the Oil-resistant Polyurethane Cable (XS5W-D42□-□81-P) is black, and the overmolding on the Vibration-proof Robot Cable (XS5W-D42□-□81-F) is warm gray.

XS5

Model Number Legend

XS5W-D42_{1 2 3 4 5}**-**_{6 7 8 9}**81-**₉

Use this model number legend to identify products from their model number. When ordering, use a model number from the table in *Ordering Information*.

1. Type

W: Connector connected to cable, plug on cable ends

2. Mating Section Form

D: DC

3. Connector Poles

4: 4 poles

4. Contact Plating

2: 0.4-μm gold plating

5. Cable Connection Direction

- 1: Straight/straight
- 2: Angled/angled
- 3: Straight (XS5F)/angled (XS5H)
- 4: Angled (XS5F)/straight (XS5H)

6. Cable Length

- C: 1 m
- D: 2 m
- E: 3 m
- G: 5 m
- J: 10m

7. Connections

8: ① Brown, ② White, ③ Blue, ④ Black (Numbers inside circles are terminal numbers)

8. Connectors on One End/Both Ends

0: Both ends

9. Cable Specifications

- A: Standard Cable
- F: Vibration-proof Robot Cable
- P: Oil-resistant Polyurethane Cable

Ordering Information

Cable specifications	Cable length L (m)	Straight/straight	Angled/angled	Minimum order	UL
		Model			
Standard Cable	1	XS5W-D421-C81-A	---	10	Yes
	2	XS5W-D421-D81-A	XS5W-D422-D81-A		
	3	XS5W-D421-E81-A	---		
	5	XS5W-D421-G81-A	XS5W-D422-G81-A	5	
	10	XS5W-D421-J81-A	---		
Vibration-proof Robot Cable	1	XS5W-D421-C81-F	---	10	
	2	XS5W-D421-D81-F	---		
	3	XS5W-D421-E81-F	---		
	5	XS5W-D421-G81-F	---	5	
	10	XS5W-D421-J81-F	---		
Oil-resistant Polyurethane Cable	2	XS5W-D421-D81-P	---	10	---
	5	XS5W-D421-G81-P	---		
	10	XS5W-D421-J81-P	---	5	

Cable specifications	Cable length L (m)	Straight/angled	Angled/straight	Minimum order	UL
		Model			
Standard Cable	2	XS5W-D423-D81-A	XS5W-D424-D81-A	10	Yes
	5	XS5W-D423-G81-A	XS5W-D424-G81-A	5	



XS5F Connector Connected to Cable, Socket on One Cable End

- Standard Cable
- Vibration-proof Robot Cable
- Oil-resistant Polyurethane Cable

XS5F-D42□-□80-A
 XS5F-D42□-□80-F
 XS5F-D42□-□80-P

Dimensions

(Unit: mm)

Straight

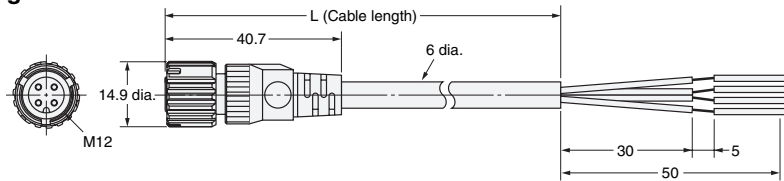

Wiring Diagram for 4 Cores

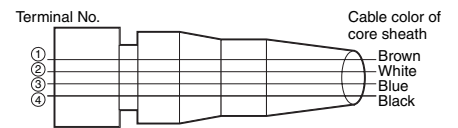

Angled

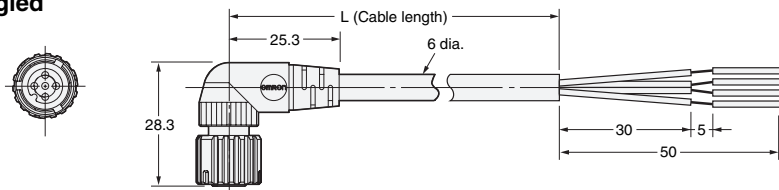

Note: The overmolding on the Standard Cable (XS5F-D42□-□80-A) and the Oil-resistant Polyurethane Cable (XS5F-D42□-□80-P) is black, and the overmolding on the Vibration-proof Robot Cable (XS5F-D42□-□80-F) is warm gray.

Model Number Legend

XS5F-D42□-□80-□
 1 2 3 4 5 6 7 8 9

Use this model number legend to identify products from their model number. When ordering, use a model number from the table in *Ordering Information*.

1. Type

H: Connector connected to cable, plug on one cable end

2. Mating Section Form

D: DC

3. Connector Poles

4: 4 poles

4. Contact Plating

2: 0.4-μm gold plating

5. Cable Connection Direction

1: Straight
 2: Angled

6. Cable Length

C: 1 m D: 2 m E: 3 m
 G: 5 m J: 10 m

7. Connections

8: ① Brown, ② White, ③ Blue, ④ Black (Numbers inside circles are terminal numbers.)

8. Connectors on One End/Both Ends

0: One end

9. Cable Specification

A: Standard Cable
 F: Vibration-proof Robot Cable
 P: Oil-resistant Polyurethane Cable

Ordering Information

Cable specifications	Cable length L (m)	Straight Connectors	Angled Connectors	Minimum order	UL
		Model			
Standard Cable	1	XS5F-D421-C80-A	XS5F-D422-C80-A	10	Yes
	2	XS5F-D421-D80-A	XS5F-D422-D80-A		
	3	XS5F-D421-E80-A	XS5F-D422-E80-A		
	5	XS5F-D421-G80-A	XS5F-D422-G80-A	5	
	10	XS5F-D421-J80-A	XS5F-D422-J80-A		
Vibration-proof Robot Cable	1	XS5F-D421-C80-F	XS5F-D422-C80-F	10	
	2	XS5F-D421-D80-F	XS5F-D422-D80-F		
	3	XS5F-D421-E80-F	XS5F-D422-E80-F		
	5	XS5F-D421-G80-F	XS5F-D422-G80-F	5	
	10	XS5F-D421-J80-F	XS5F-D422-J80-F		
Oil-resistant Polyurethane Cable	2	XS5F-D421-D80-P	XS5F-D422-D80-P	10	---
	5	XS5F-D421-G80-P	XS5F-D422-G80-P	5	
	10	XS5F-D421-J80-P	XS5F-D422-J80-P		

XS5H Connector Connected to Cable, Plug on One Cable End

- Standard Cable
- Vibration-proof Robot Cable
- Oil-resistant Polyurethane Cable

XS5H-D42□-□80-A
 XS5H-D42□-□80-F
 XS5H-D42□-□80-P

Dimensions

(Unit: mm)

Straight

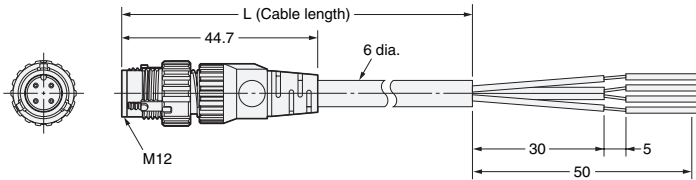

Wiring Diagram for 4 Cores

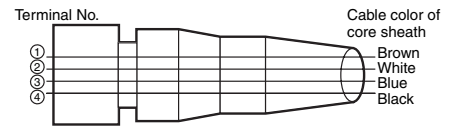

Angled

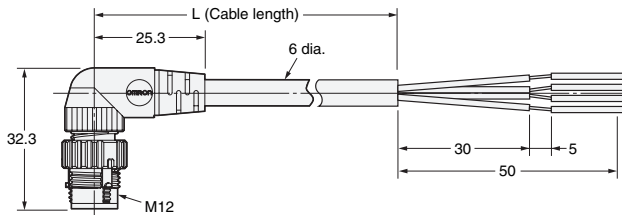

Note: The overmolding on the Standard Cable (XS5H-D42□-□80-A) and the Oil-resistant Polyurethane Cable (XS5H-D42□-□80-P) is black, and the overmolding on the Vibration-proof Robot Cable (XS5H-D42□-□80-F) is warm gray.

Model Number Legend

XS5H-D42□-□80-□
 1 2 3 4 5 6 7 8 9

Use this model number legend to identify products from their model number. When ordering, use a model number from the table in *Ordering Information*.

1. Type

H: Connector connected to cable, plug on one cable end

2. Mating Section Form

D: DC

3. Connector Poles

4: 4 poles

4. Contact Plating

2: 0.4-μm gold plating

5. Cable Connection Direction

- 1: Straight
- 2: Angled

6. Cable Length

A: 0.3 m C: 1 m D: 2 m
 G: 5 m

7. Connections

- 8: ① Brown, ② White, ③ Blue, ④ Black (Numbers inside circles are terminal numbers)

8. Connectors on One End/Both Ends

0: One end

9. Cable Specifications

A: Standard Cable
 F: Vibration-proof Robot Cable
 P: Oil-resistant Polyurethane Cable

Ordering Information

Cable specifications	Cable length L (m)	Straight Connectors	Angled Connectors	Minimum order	UL
		Model			
Standard Cable	0.3	XS5H-D421-A80-A	XS5H-D422-A80-A	10	Yes
	1	XS5H-D421-C80-A	XS5H-D422-C80-A		
	2	XS5H-D421-D80-A	XS5H-D422-D80-A		
	5	XS5H-D421-G80-A	XS5H-D422-G80-A		
Vibration-proof Robot Cable	0.3	XS5H-D421-A80-F	XS5H-D422-A80-F	10	---
	1	XS5H-D421-C80-F	XS5H-D422-C80-F		
	2	XS5H-D421-D80-F	XS5H-D422-D80-F		
	5	XS5H-D421-G80-F	XS5H-D422-G80-F		
Oil-resistant Polyurethane Cable	0.3	XS5H-D421-A80-P	XS5H-D422-A80-P	10	---
	2	XS5H-D421-D80-P	XS5H-D422-D80-P		
	5	XS5H-D421-G80-P	XS5H-D422-G80-P		

XS5G NEW Assembly Connector Plugs

Dimensions

(Unit: mm)

XS5G-D4C□ (Crimping Model)
XS5G-D42□ (Soldering Model)
Straight Connectors

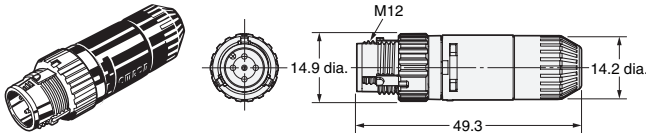

XS5G-D42□ (Soldering Model)
Angled Connectors

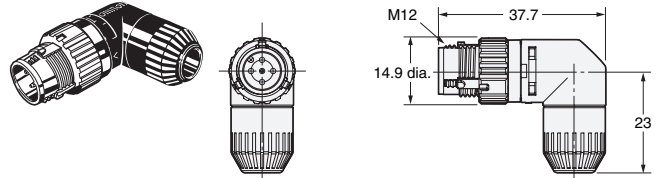

XS5G-D□S□ (Screw-on Connectors, Applicable Cable Outer Diameter: 7 or 8 mm)
Straight Connectors

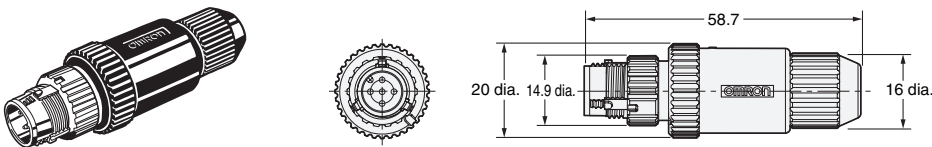

XS5G-D□S□ (Screw-on Connectors, Applicable Cable Outer Diameter: 3, 4, or 6 mm)
Straight Connectors

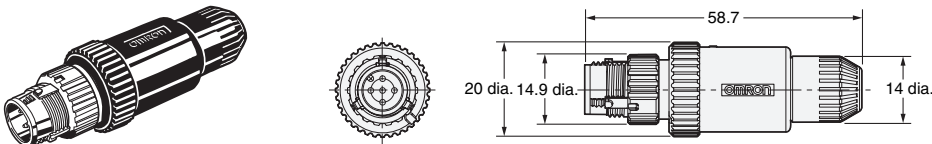

XS2G-D□S□ (Screw-on Connectors)
Angled Connectors

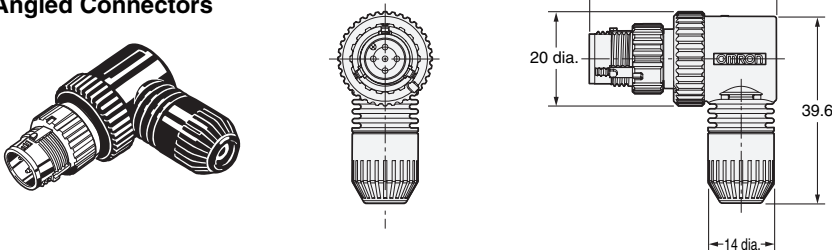

Ordering Information

No. of poles	Connection method	Suitable cable dia. (mm)	Straight Connectors	Angled Connectors	Minimum order
			Model		
4	Crimping	6 mm (5 to 6)	XS5G-D4C1	---	50
		4 mm (4 to 5)	XS5G-D4C3	---	
		3 mm (3 to 4)	XS5G-D4C5	---	
	Soldering	6 mm (5 to 6)	XS5G-D421	XS5G-D422	
		4 mm (4 to 5)	XS5G-D423	XS5G-D424	
		3 mm (3 to 4)	XS5G-D425	XS5G-D426	
	Screw-on	6 mm (5 to 6)	XS5G-D4S1	XS5G-D4S2	
		4 mm (4 to 5)	XS5G-D4S3	XS5G-D4S4	
		3 mm (3 to 4)	XS5G-D4S5	XS5G-D4S6	
8 mm (7 to 8)		XS5G-D4S7	---		
5	Screw-on	7 mm (6 to 7)	XS5G-D4S9	---	
		6 mm (5 to 6)	XS5G-D5S1	---	
		4 mm (4 to 5)	XS5G-D5S3	---	
		3 mm (3 to 4)	XS5G-D5S5	---	
		8 mm (7 to 8)	XS5G-D5S7	---	
		7 mm (6 to 7)	XS5G-D5S9	---	

Note: XS5G Screw-on Plugs cannot be connected to side by side to the CN1 and CN2 connectors of XS2R or XS5R Y-Joint Sockets/Plugs.

XS5U NEW (Crimping Pin for XS5G)



Dimensions

(Unit: mm)

XS5U-312□
Plug Pin

* A special tool must be used for crimping. For details, refer to page 16.

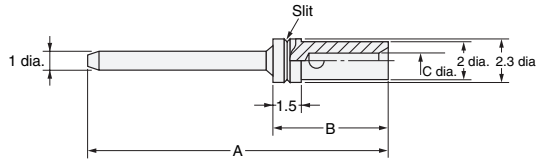
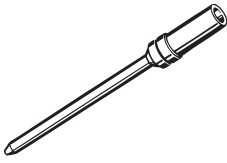

Dimensions

Model	Suitable core size (mm ²)	Dimension (mm)			No. of slits
		A	B	C	
XS5U-3121	0.18 to 0.3	22.6	6.1	0.8	1
XS5U-3122	0.5 to 0.75	22.7	6.2	1.3	0

Ordering Information

Suitable core size (mm ²)	Model	Minimum order
0.18 to 0.3	XS5U-3121	100
0.5 to 0.75	XS5U-3122	

Note: Orders are accepted in multiples of the minimum order.

XS5C NEW Assembly Connector Sockets



Dimensions

(Unit: mm)

**XS5C-D4C□ (Crimping Model)
XS5C-D42□ (Soldering Model)
Straight Connectors**

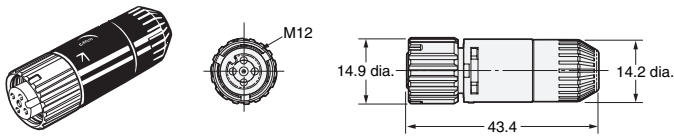

**XS5C-D4C□ (Crimping Model)
XS5C-D42□ (Soldering Model)
Angled Connectors**

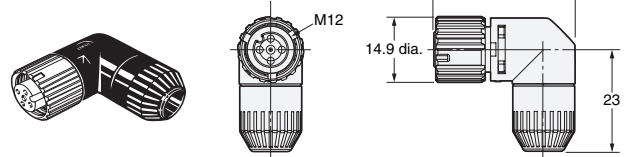

**XS5C-D□S□ (Screw-on Connectors, Applicable Cable Outer Diameter: 7 or 8 mm)
Straight Connectors**

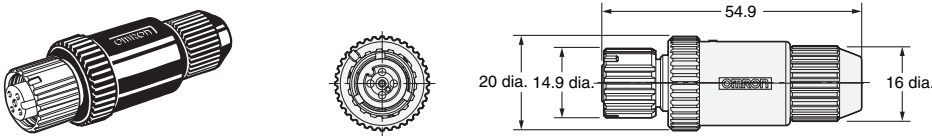

**XS5C-D□S□ (Screw-on Connectors, Applicable Cable Outer Diameter: 3, 4, or 6 mm)
Straight Connectors**

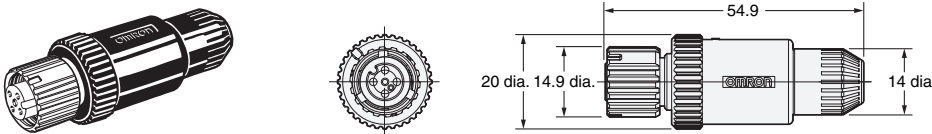

**XS5C-D□S□ (Screw-on Connectors)
Angled Connectors**

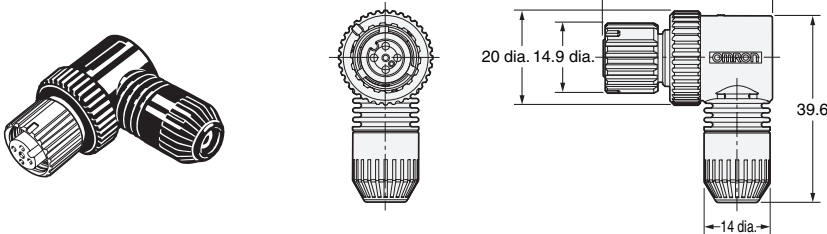

Ordering Information

No. of poles	Connection method	Suitable cable dia. (mm)	Straight Connectors		Angled Connectors		Minimum order
			Model				
4	Crimping	6 mm (5 to 6)	XS5C-D4C1	XS5C-D4C2			50
		4 mm (4 to 5)	XS5C-D4C3	XS5C-D4C4			
		3 mm (3 to 4)	XS5C-D4C5	XS5C-D4C6			
	Soldering	6 mm (5 to 6)	XS5C-D421	XS5C-D422			
		4 mm (4 to 5)	XS5C-D423	XS5C-D424			
		3 mm (3 to 4)	XS5C-D425	XS5C-D426			
	Screw-on	6 mm (5 to 6)	XS5C-D4S1	XS5C-D4S2			
		4 mm (4 to 5)	XS5C-D4S3	XS5C-D4S4			
		3 mm (3 to 4)	XS5C-D4S5	XS5C-D4S6			
8 mm (7 to 8)		XS5C-D4S7	---				
7 mm (6 to 7)		XS5C-D4S9	---				
5	Screw-on	6 mm (5 to 6)	XS5C-D5S1	---			
		4 mm (4 to 5)	XS5C-D5S3	---			
		3 mm (3 to 4)	XS5C-D5S5	---			
		8 mm (7 to 8)	XS5C-D5S7	---			
		7 mm (6 to 7)	XS5C-D5S9	---			

XS5U NEW (Crimping Pin for XS5C)



Dimensions

(Unit: mm)

XS5U-222
Socket Pin

* A special tool must be used for crimping. For details, refer to page 16.

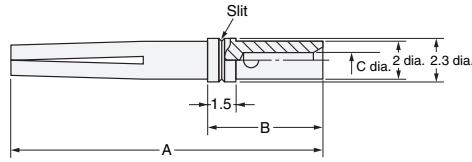
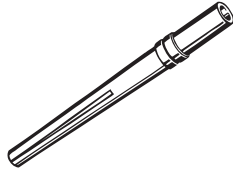

Dimensions

Model	Suitable core size (mm ²)	Dimension (mm)			No. of slits
		A	B	C	
XS5U-2221	0.18 to 0.3	16.7	6.1	0.8	1
XS5U-2222	0.5 to 0.75	16.8	6.2	1.3	0

Ordering Information

Suitable core size (mm ²)	Model	Minimum order
0.18 to 0.3	XS5U-2221	100
0.5 to 0.75	XS5U-2222	

Note: Orders are accepted in multiples of the minimum order.

XS5R Y-Joint Plug/Socket Connectors

Dimensions

(Unit: mm)

XS5R-D426-□11-F

Connectors on Both Ends (Y-Joint Plug/Socket)

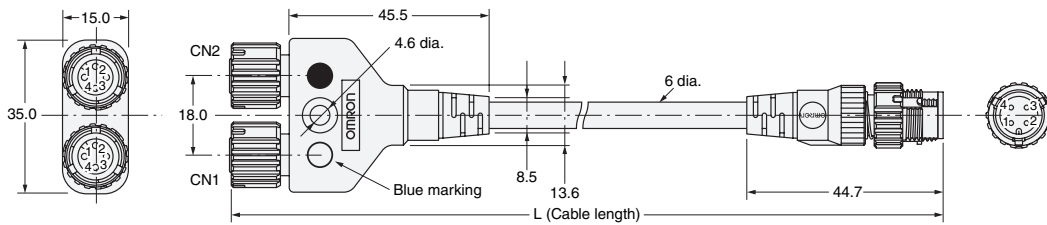

Wiring Diagram

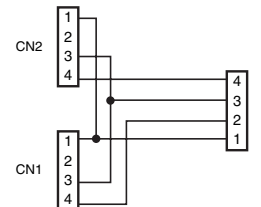

XS5R-D426-□10-F

Connectors on One Cable End (Y-Joint Socket)

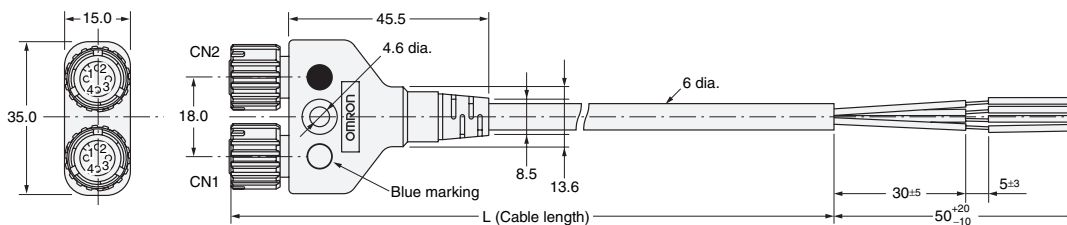

Wiring Diagram

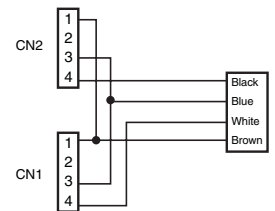

XS5R-D426-□

Y-Joint Plug/Socket without Cable

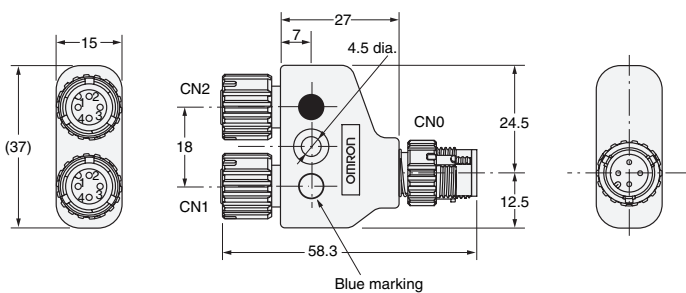

Wiring Diagram

XS5R-D426-1

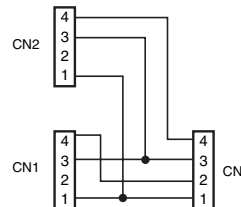

XS5R-D426-5

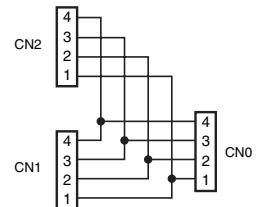

Ordering Information

Cable	Connector	Cable length (m)	Model	Minimum order
With cable	Connectors on both cable ends	0.5	XS5R-D426-B11-F	5
		1	XS5R-D426-C11-F	
		2	XS5R-D426-D11-F	
		3	XS5R-D426-E11-F	
	Connector on one cable end	2	XS5R-D426-D10-F	
		5	XS5R-D426-G10-F	
With no cable	Y-Joint Plug/Socket	---	XS5R-D426-1	10
		---	XS5R-D426-5	

Note: 1. Ask your OMRON representative about other specifications.

2. XS2G and XS5G Assembled Connectors with screw connections cannot be connected to both CN1 and CN2 at the same time.

XS5P Panel-mounting Sockets

Dimensions

(Unit: mm)

XS5P-D426-5

Panel-mounting Sockets with Rear Locks

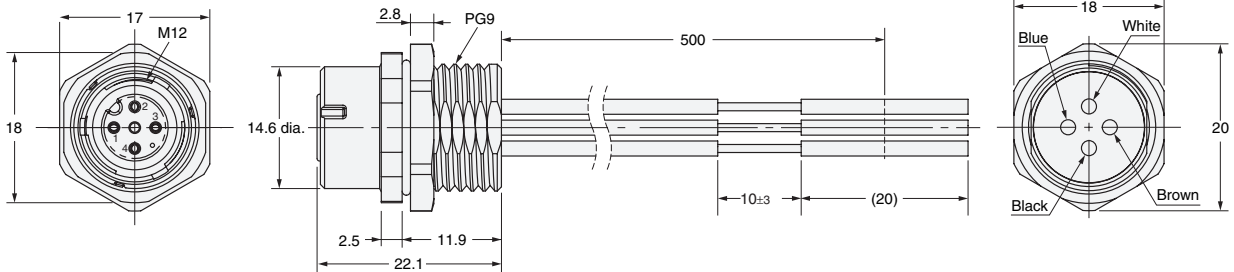

XS5P-D427-5

Panel-mounting Sockets with Front Locks

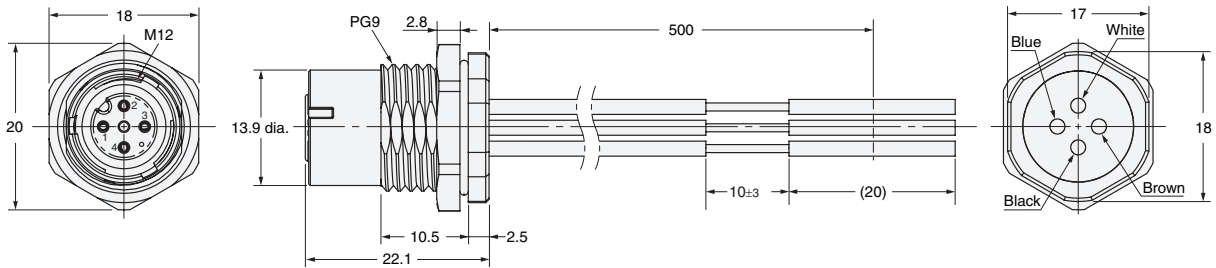

Panel Cutout

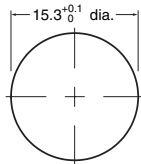

Panel Cutout Dimension
Panel thickness = 1 to 4 mm

- Note:**
1. The panel cutout dimension is the same for Front-locking and Rearlocking Sockets.
 2. Rotational positioning is not possible for connector rotation.

Wiring and Wire Specifications

Wiring

Pin number	Color
1	Brown
2	White
3	Blue
4	Black

Wire Specifications

Item	Specification	
Specification	UL1007	
Nominal size	AWG20	
Configuration	Number of wires	21
	Wire diameter	0.18
	Standard outer diameter	1.8

Ordering Information

Type	Lock	Cable length (m)	Model	Minimum order
With cable	Rear lock	0.5	XS5M-D426-5	10
	Front lock		XS5M-D427-5	

XS5M Panel-mounting Plugs

Dimensions

(Unit: mm)

XS5M-D426-5

Panel-mounting Plugs with Rear Locks

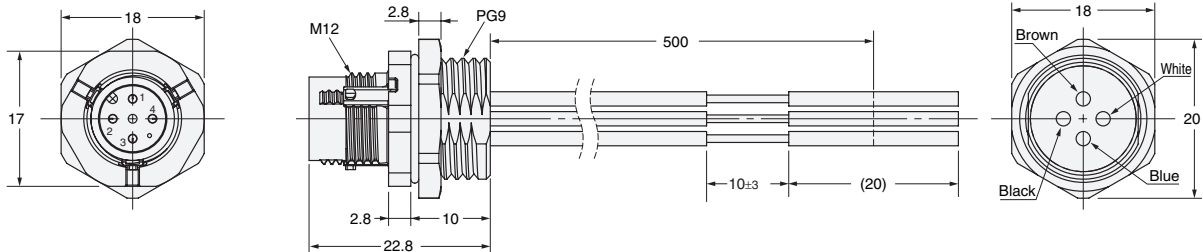

XS5M-D427-5

Panel-mounting Plugs with Front Locks

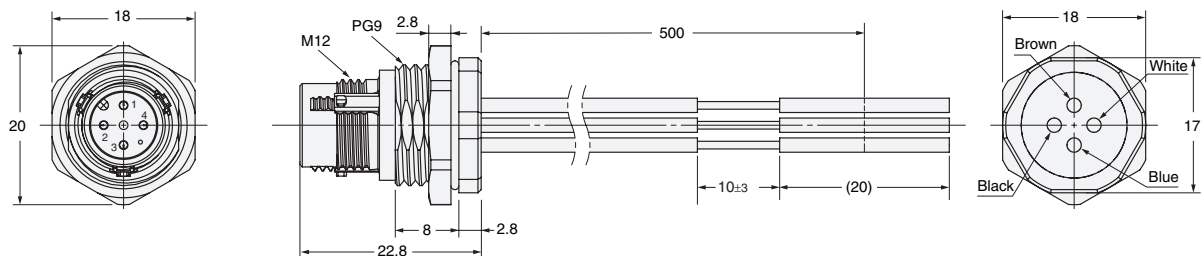

Panel Cutout

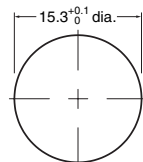

Panel Cutout Dimension
Panel thickness = 1 to 4 mm

- Note:**
1. The panel cutout dimension is the same for Front-locking and Rearlocking Sockets.
 2. Rotational positioning is not possible for connector rotation.

Wiring and Wire Specifications

Wiring

Pin number	Color
1	Brown
2	White
3	Blue
4	Black

Wire Specifications

Item	Specification	
Specification	UL1007	
Nominal size	AWG20	
Configuration	Number of wires	21
	Wire diameter	0.18
	Standard outer diameter	1.8

Ordering Information

Type	Lock	Cable length (m)	Model	Minimum order
With cable	Rear lock	0.5	XS5M-D426-5	10
	Front lock		XS5M-D427-5	

XS5

Tools

Crimp Tool XY2F-0002

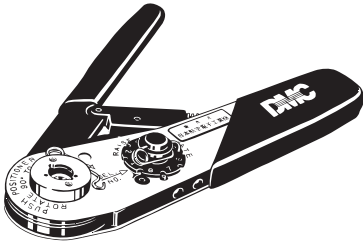

Use the Crimp Tool to crimp a cable core to the XS5U or XS2U Crimping Pin used with the XS□C or XS□G Crimping Connector.

- The XY2F-0002 Crimp Tool is DMC's AFM8 (M22520/2-01).
- Mount the XY2F-0003 Locator (sold separately) to the locator guide of the Crimp Tool with a screw provided with the XY2F-0003 Locator.

Locator XY2F-0003

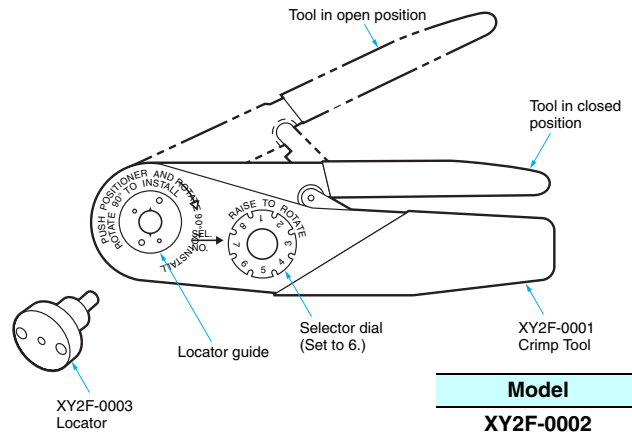

Model
XY2F-0002
XY2F-0003

Pin-block Extraction Tool XY2F-0001

Use this tool to extract a Pin Block from the covers in order to make wiring changes or corrections after the cover has been mounted to the pin block for Connector Assemblies (XS□C/XS□G, soldering/crimping).

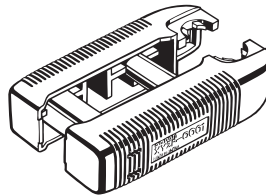

Model
XY2F-0001

Extraction Procedure

(1) Disconnecting Components

- Disconnect all components on the cap side from the cover.

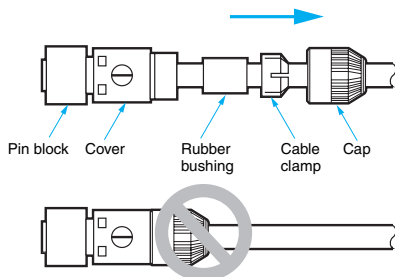

(2) Extracting Pin Block

- Insert the claws of the Tool into the four holes of the cover.

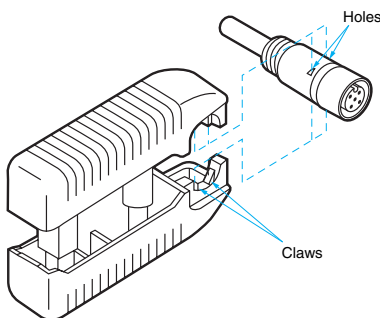

- Make sure that the pin block is outside the Tool.

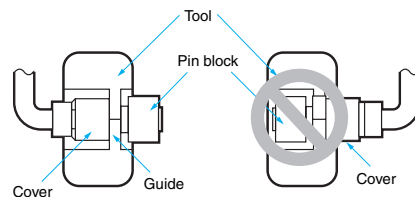

- Press the Tool so that the guides of the Tool are in close contact. Then pull the pin block straight.

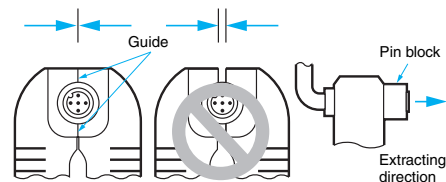

Precaution for Safe Use

- The pin block must not be extracted from the same Connector more than 3 times, otherwise the proper degree of protection of the pin block or Connector will not be maintained.

Assembly Procedure for XS5C/XS5G Connector Assemblies

(1) Connector and Cable External Diameters

- Connectors for 6-, 4-, and 3-mm-diameter Cables (i.e., Cables that are 5 to 6, 4 to 5, and 3 to 4 mm in diameter respectively) are available. When assembling a Connector used with a cable, make sure that the external diameter of the Connector is suited to that of the cable.
 - Connectors for 6-mm-diameter Cables use white cable clamps. Connectors for 4- and 3-mm-diameter Cables use black cable clamps.
- A watertight bushing for 6-mm-diameter Cable has no stripe, that for 4-mm-diameter Cable has a single stripe, and that for 3-mm-diameter Cable has two stripes.

Note: When connecting a commercially available cable to a connector assembly, use a cable with an outside diameter of 3 to 6 mm and core sizes of 0.18 to 0.75 mm² for crimping connectors and 0.5 mm² maximum for soldering connectors.

(2) Component Insertion

Crimping/Soldering Connectors

Straight Connectors

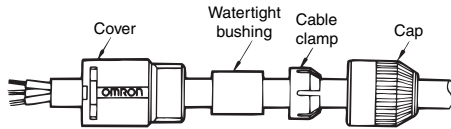

Angled Connectors

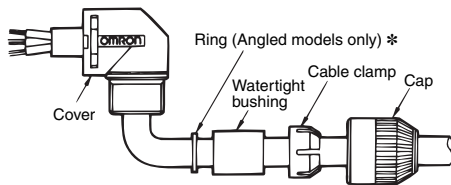

* A ring is not required for Screw-on Connectors.

- As shown in the above illustration, connect the above components to the Cable with its end processed.

Screw-on Connectors

Confirm that you have all of the required parts.

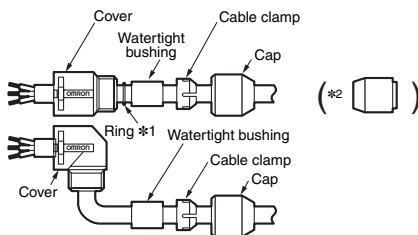

Insulation caps and insulation tubes are included with 5-pole Connectors (XS2C-D5S□ and XS2G-D5S□).

- *1. Rings are not required with 7-mm and 8-mm cables.
- *2. Insert the waterproof bushing for 7-mm and 8-mm cables in the direction shown in the diagram.

(3) Wiring (Processing Cable Ends)

Soldering Connectors

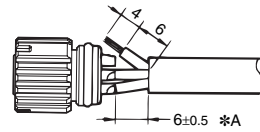

- Strip 10 mm of the Cable sheath and 4 mm of each core.
- Before soldering cores and solder cup pins together, solder-coat each of them.
- The following conditions are recommended for soldering each solder cup pin.
 - Soldering iron: 30 to 60 W
 - Soldering temperature: 280°C to 340°C
 - Soldering period: 3 s max.
- The length marked *A should be 6.5 mm max., otherwise the proper degree of protection of the connector will not be maintained.

Crimping Connectors

Crimping

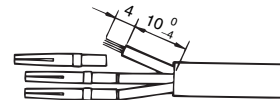

- Strip 14 mm of the Cable sheath and 4 mm of each core.
- Make sure that each core is not damaged and its end strands are not spread out.
- Mount the XY2F-0003 Locator to XY2F-0002 Crimping Tool, both of which are sold separately, and set the selector dial of the Crimping Tool to 6 for the XS5U-□□21 and to 7 for the XS5U-□□22.
- After mounting the crimping pins to the Locator, fully insert the cores to the crimping pins.
- Squeeze the handle of the Crimp Tool to press-fit the cores to the crimping pins. (Squeeze the handle firmly until the handle automatically returns to the release position.)

Wiring

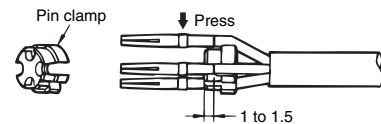

- After press-fitting the cores to the pins, insert the pins into the pin clamp as shown in the illustration. Then make sure that the lead colors correspond to the pin clamp numbers that are identical to the connector pin numbers.

Insertion

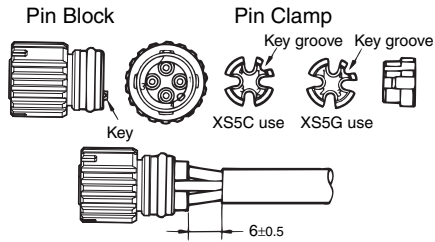

- Tentatively insert the pins to the pin block holes so that the key on the pin block will coincide with the key groove on the pin clamp. Then insert the cable along with the pin clamp.

Screw-on Connectors

Cable End Processing

• Four-pole Connectors

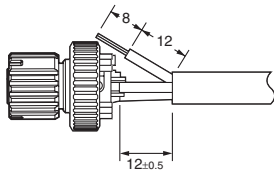

- Loosen the screws on pins 1 to 4 and insert the cores according to the pin numbers.

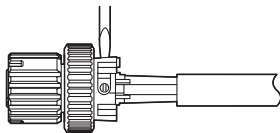

- Use the dedicated Screwdriver (XW4Z-00B)* and tighten the screws securely so that the cores do not pull out (tightening torque: 0.15 to 0.2 N·m).

• Five-pole Connectors

- Strip the cable sheath for a total of 15 mm and strip the core covering for 8 mm for the core to connect to pin 5.

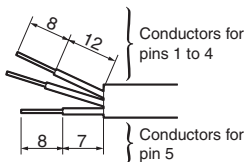

- Connect the core to pin 5 (in the center) first.
- Insert the core from the side of the hold with the tab and tighten the screw securely (tightening torque: 0.15 to 0.2 N·m), and then cut off the excess wire with wire cutters.

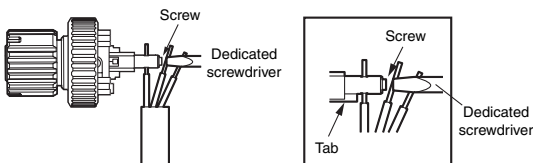

- Bend the cable as shown below, attached the enclosed insulation cap, and then strip the other cores.

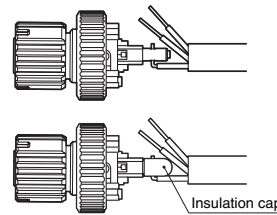

- Connect the cores to pins 1 to 4.

Connecting Shielded Cables to Five-pole Connectors

- Place the insulation tub on the drain line of the shield and connect it to the terminal.
- Tighten the screw and then check visually to see if there is insulation between the cores.

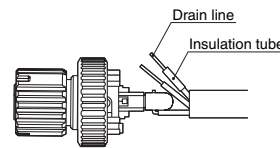

- Connect the cores to pins 1 to 4.
- * When tightening the screws, use the dedicated XW4Z-00B Screwdriver that matches with the screw-slot dimensions.

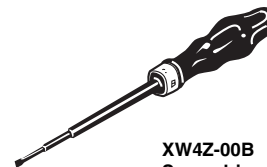

**XW4Z-00B
Screwdriver**

(4) Inserting Pin Block

**Pin Block
(Soldering Model)**

**Cover
(Straight Model)**

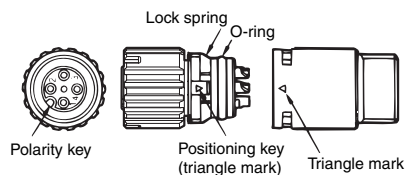

(Crimping Model)

(Angled Model)

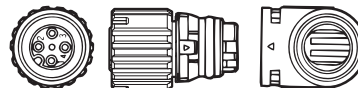

- Mount the cover to the pin block so that the triangle mark on the pin block will coincide with the triangle mark on the cover.
- If the cover is used for an Angled model, the relationship between the position of the polarity key on the engaged side and cable connection direction will be determined by the direction in which the positioning key is inserted into the cover, which can be rotated by 90°.
- Fully insert the positioning key until the positioning key is hidden by the casing.

Connecting the XS5

Pin Block (Screw-mounting Connectors)

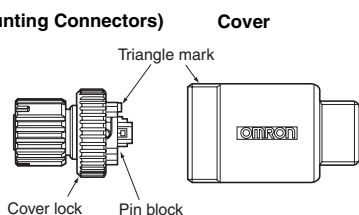

- Align the triangular marks on the pin block and cover and insert the pin block into the cover.
- Press them together firmly (0.39 to 0.49 N·m) until the pin block does not come out of the cover.

(5) Mounting Cap

- After mounting the cover to the pin block and the cover snaps into place, tighten the cap securely by hand within a torque of 0.39 and 0.49 N·m.

Note: If the cap is not tighten securely enough, the degree of protection (IP67) may not be maintained or vibration may cause the cap to become loose. Do not tighten the cap with pliers or similar tools; they may damage the cap.

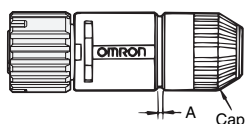

- After fully tightening the cap, length A should be approximately one of the following according to the cable external diameter and the Connector model.

Connector	Cable external diameter (mm)			
	6 mm	5 mm	4 mm	3 mm
For 6-mm-dia. cable	1	0	---	---
For 4-mm-dia. cable	---	2	1	---
For 3-mm-dia. cable	---	---	2	1

(6) After Assembly

- Confirm the insulation between cores after completing assembly.

Recommended Cables

When connecting a commercially available cable to a connector assembly, use a cable with an outside diameter of 3 to 6 mm and core sizes of 0.18 to 0.75 mm² for crimping connectors and 0.5 mm² maximum for soldering connectors.

Connector Arrangement

For safety, when constructing a connection system between a Sensor and panel with a connector, make sure that the connector plug is on the Sensor side and the connector socket is on the panel side (i.e., the female pins are located on the power-supply side).

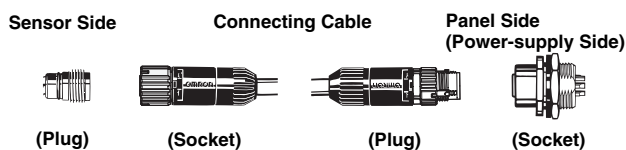

1. Connecting the XS5 Plug and Socket

- Align the projection on the plug cover with the polarity key on the socket, then insert the plug all the way in.

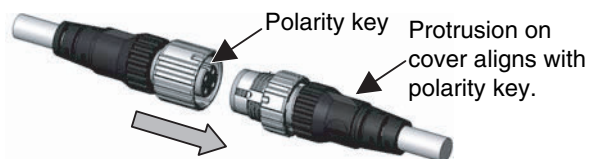

- Hold the knurled socket grip, then insert the projection on the plug into the groove of the socket.



- Turn the knurled grips of the socket clockwise approximately 45 degrees in respect to the plug. A click will indicate that the Connectors are locked. The locking condition can also be confirmed by the alignment marks on the plug and socket.

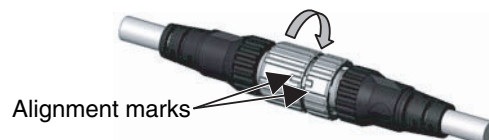

2. Connecting the XS5 and XS2

- Align the projection on the plug cover with the polarity key on the socket, then insert the plug all the way in.
- In the same way as when connecting two XS2 Connectors, screw the knurled grip in the clockwise direction.
- Use your fingers to tighten the Connectors sufficiently.

Safety Precautions

Precautions for Correct Use

Do not use the Connectors in an atmosphere or environment that exceeds the specifications.

Connector Connection and Disconnection

- When connecting or disconnecting Connectors, be sure to hold the Connectors by hand.
- Do not hold the cable when disconnecting Connectors.
- When mating Connectors, be sure to insert the plug all the way to the back of the socket before attempting to lock the Connectors.
- Do not use tools of any sort to mate the Connectors. Always use your hands. Pliers or other tools may damage the Connectors.
- When mating the Connectors to XS2 or other M12 Connectors, tighten the lock by hand to a torque of 0.39 to 0.49 N·m.

Wiring

- Always confirm wiring diagrams before wiring sensors, limit switches, or other devices.
- Lay the cables so that external force is not applied to the Connectors. Otherwise, the degree of protection (IP67) may not be achieved.

Degree of Protection

- The degree of protection of Connectors (IP67) is not for a fully watertight structure. Do not the Connectors underwater.
- Do not step on or place any objects on the Connectors. Doing so may damage the Connectors.

General Precautions

- Do not pull excessively on the Connectors or cables. Do not install the Connectors or cables in any way that would place a load directly on the mating section or cable connections. Doing so can damage the Connectors or break the wires inside the cables.
- Install the Connectors and cables where they will not be stepped on to prevent the wires inside the cables from being broken and to prevent the Connectors from being damaged. If the Connectors or cables must be installed where they might be stepped on, protect them with covers.
- Refer to the specifications for your cables before bending the cables and do not bend them past their minimum bending radius.
- If sensors or switches are not attached during installation, protect the mating surface of the Connector with a XS2Z-22 Waterproof Cover or XS2Z-14/15 Dust Cover.

Connector Terminal Boxes

XW3D

Simple Wiring of Sensor Actuators

- Greatly reduce wiring in combination with the Smartclick XS5.
- Insert the connector and turn 1/8 of a turn to lock the connectors.
- Higher rated current to enable output applications.
- Use previous M12 screw connectors.

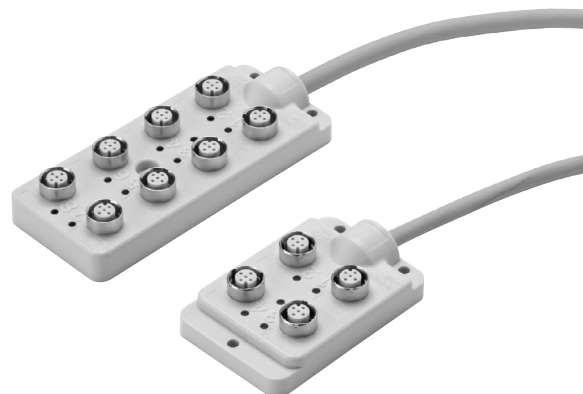

Specifications

Rated current	4 A/port, 12 A/Box (power line)
Rated voltage	10 to 30 VDC
Contact resistance (connector)	40 mΩ max. (20 mV max., 100 mA max.)
Insulation resistance	1,000 MΩ min. (at 500 VDC)
Dielectric strength (connector)	500 VAC for 1 min (leakage current: 1 mA max.)
Degree of protection	IP67 (IEC60529)
Insertion tolerance	50 times min.
Lock strength	Pulling: 100 N/15 s, Twisting: 1 N·m/15 s
Cable holding strength	100 N/15 s
Lock operating force	0.1 N·m to 0.25 N·m
Ambient temperature range	Operating: -25 to 70°C

Materials and Finish

Item	Materials/finish
Contacts	Brass/nickel base, 0.4-μm gold-plating
Fixtures	Nickel-plated zinc alloy
Case	PBT resin (UL94V-O), light gray
Bushing	Rubber
O-ring	Rubber
PCB	Glass epoxy board
Sealing resin	Urethane resin (UL94V-0)
Cable	UL AWM2464 Signal lines: AWG22 Power and ground lines: AWG18

Connection Combinations

OMRON model no.		Twist-and-Click Plug Connectors	M12 Plug Connectors
		XS5H, XS5G, XS5W (plug end), XS5R (plug end)	XS2H, XS2G, XS2W (plug end), XS2R (plug end)
Connector Terminal Box	XW3D	◎	○

◎: Connected by Smartclick.
○: Connected by screwing.

Smartclick is a registered trademark of the OMRON Corporation.

Ordering Information

Sensor type and wiring		3-wire DC NPN/2-wire DC 3-4	2-wire DC 1-4/without polarity 3-4	3-wire DC PNP/2-wire DC 1-4
Actuator wiring		Actuator wiring 1-4	---	Actuator wiring 3-4
No. of ports	No. of I/O	Model		
4	4	XW3D-P455-G11	XW3D-P452-G11	XW3D-P453-G11
8	8	XW3D-P855-G11	XW3D-P852-G11	XW3D-P853-G11
4	8	XW3D-P458-G11	---	XW3D-P457-G11

Note: 1. "1-4" and "3-4" are the connector pin numbers that are wired.
 2. All cables are 5 m long.

Waterproof Cover (Sold Separately)

XS2Z-22



Model	No. per box	Material
XS2Z-22	50	Brass with Ni plating

Note: 1. The XW3D/XW3B/XW3A comes with a dust cover. Use the optional XS2Z-22 Waterproof Cover when an IP67 degree of protection is required.
 2. The XS2Z-22 connection is threaded.

Dimensions

(Unit: mm)

XW3D-P45□-G11 (Model with Four Ports)

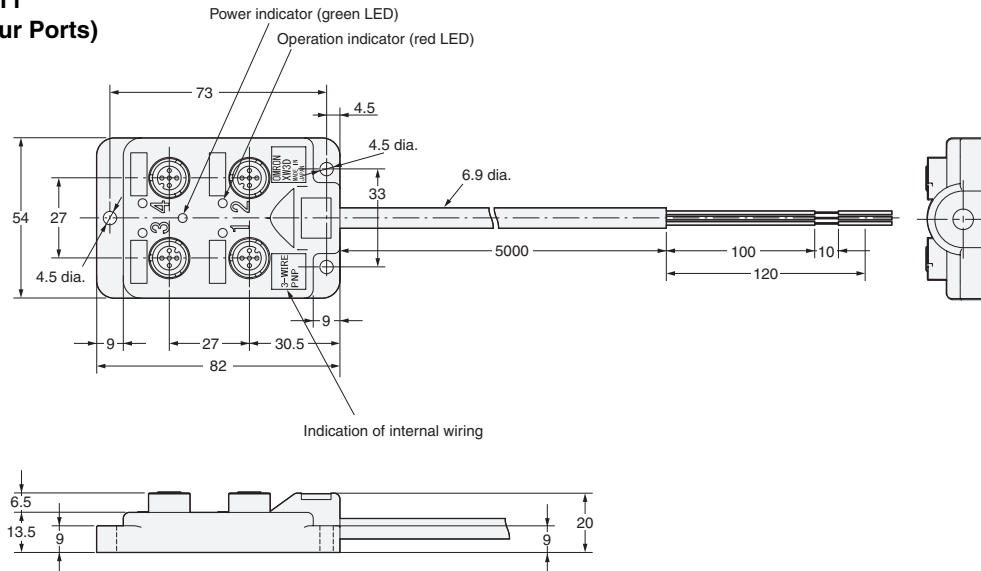

XW3D-P85□-G11 (Model with Eight Ports)

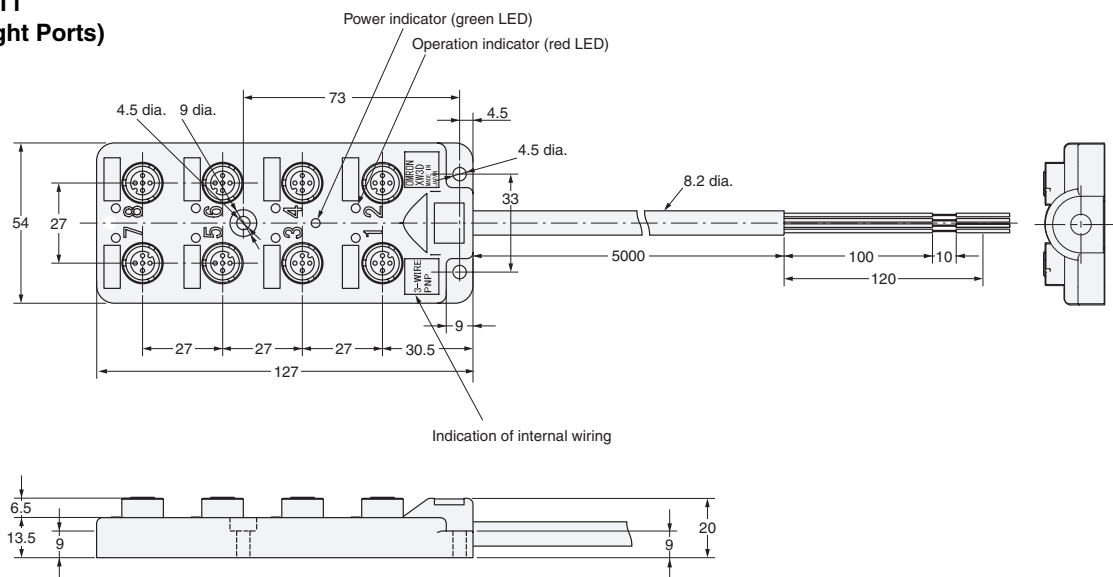

XW3D-P457-G11

(Model with Four Ports and Eight I/O)

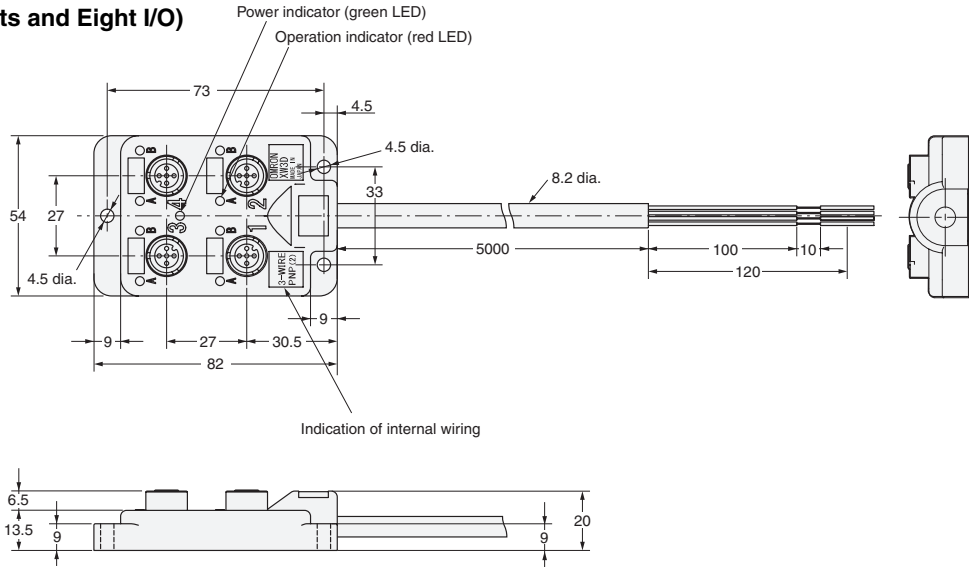

Wiring Diagrams

Models with One I/O and One Port

XW3D-P□55-□11

for 3-wire NPN,
2-wire DC (without polarity 3-4),
and Actuator (1-4)

3-WIRE
NPN

XW3D-P□52-□11

for 2-wire DC
(polarity 1-4, without polarity 3-4)

2-WIRE

Note: Cannot be used with NPN-type Photoelectric and Proximity Sensors. Cannot be used with Proximity Sensors with polarity 3-4.

XW3D-P□53-□11

for 3-wire PNP,
2-wire DC (with polarity 1-4),
and Actuator (3-4)

3-WIRE
PNP

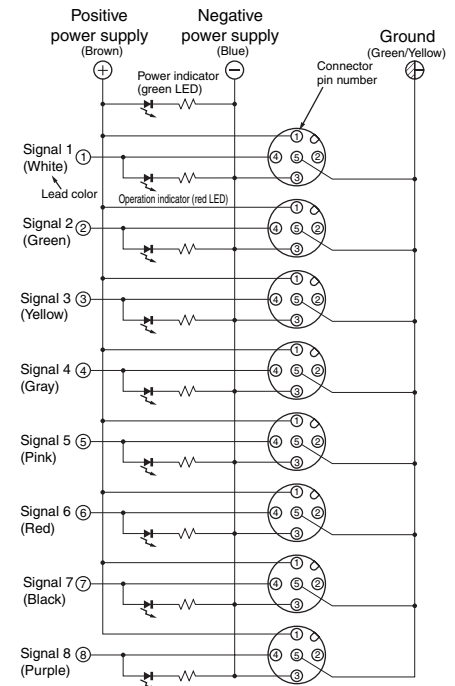
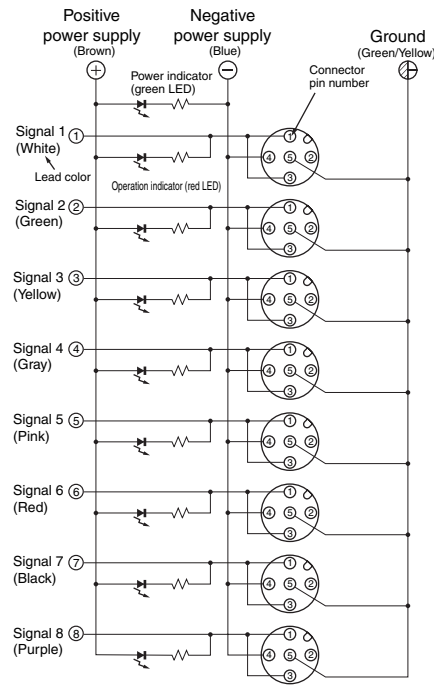
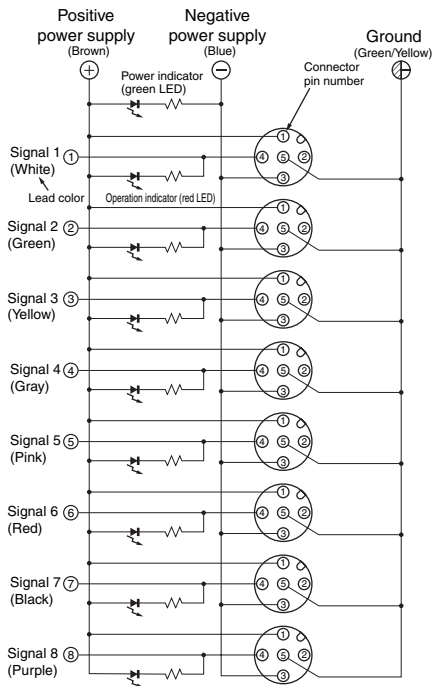

- Note:**
1. The above wiring diagrams are for eight-port use.
 2. Figures in parentheses indicate lead colors.
 3. The expression "white/red" means white and red stripes.
 4. Here, "1-4" and "3-4" are pin numbers.
 5. Contact numbers 5 through 8 in the above diagrams do not exist on Terminal Boxes with four ports. The lead colors for signals 1 through 4, power supply, and ground are the same.

Models with Two I/O and One Port

XW3D-P458-G11 for 3-wire NPN and Actuator (1-4 or 1-2)

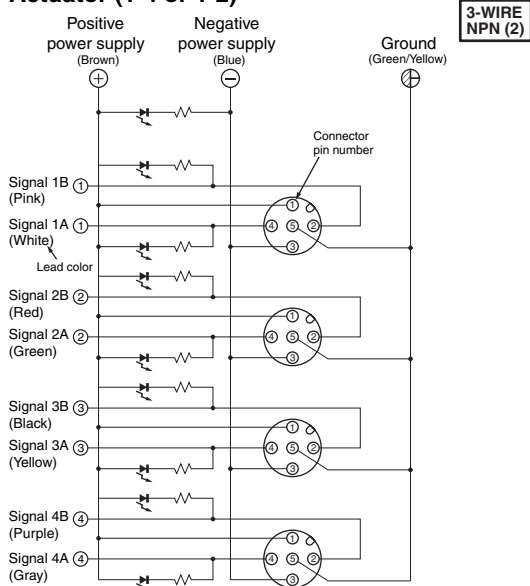

Note: Colors given in the connection diagram are lead colors.

XW3D-P457-G11 for 3-wire PNP and Actuator (3-4 or 3-2)

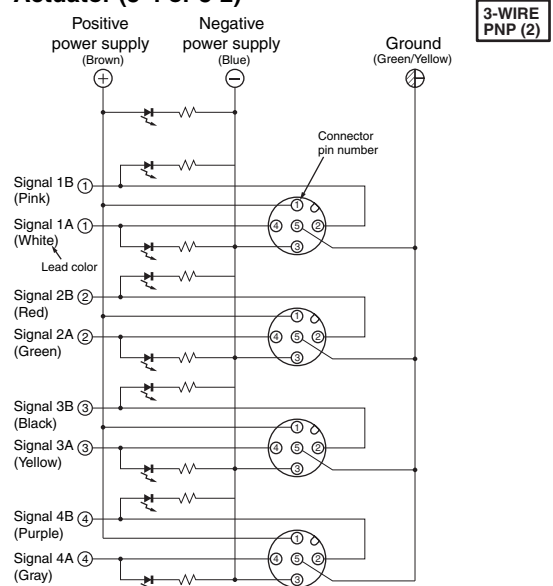

Mounting Dimensions

(Unit: mm)

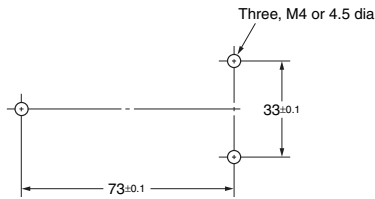

Note: The mounting dimensions are the same regardless of the number of ports.

Safety Precautions

Precautions for Correct Use

Do not use the Connectors in an atmosphere or environment that exceeds the specifications.

Connector Connection and Disconnection

- Mate the connectors according to the procedure given on page 19.
- When mating Connectors, be sure to insert the plug all the way to the back of the socket before attempting to lock the Connectors.
- Do not use tools of any sort to mate the Connectors. Always use your hands. Pliers or other tools may damage the Connectors.
- When mating the Connectors to XS2 or other M12 Connectors, tighten the lock by hand to a torque of 0.39 to 0.49 N·m.
- Confirm in the catalog that sensors and actuators are applicable before using them.
- Always turn OFF the power supply before connecting or disconnecting connectors.
- Do not touch the mating surface of the connectors with wet hands.
- Wipe away any water around the connectors.
- Do not allow metal scraps or dust to enter the mating section.

Cable Lead Polarity

- Connect the cables leads using the correct polarity (Blue: Negative power supply, Brown: Positive power supply).
- If the polarity is not correct, the load may not operate or the operation indicator may not light.
- Always connect a load to the signal lines to operate a sensor or actuator.

Applicable Connectors

- Always mount a Waterproof Cover (XS2Z-22) or Dust Cover (XS2Z-15) to any unused connector on the Connector Terminal Box.

Power Supply and Operation Indicators

- The power supply indicator will be lit green while power is being supplied. The operation indicator will be lit red while the sensor or actuator is operating.
- The XW3D is for a DC sensor or actuator. Do not use it for an AC sensor or actuator.
- Connector Terminal Boxes are available with either 2-wire or 3-wire internal connections, as indicated on the case.

3-WIRE NPN

2-WIRE

3-WIRE PNP

3-WIRE NPN (2)

3-WIRE PNP (2)

XS5-compatible Products

Photoelectric Sensors

E3ZM-C Oil-resistant, Robust, Compact Photoelectric Sensor (Stainless Housing and Built-in Amplifier)

Orange light Red light Infrared light

Sensing method	Appearance		Sensing distance	Model	
				NPN output	PNP output
Through-beam			15 m	E3ZM-CT61-M1TJ	E3ZM-CT81-M1TJ
			20 m	E3ZM-CT62B-M1TJ	E3ZM-CT82B-M1TJ
Retro-reflective			4 m [100 mm]* (Using E39-R1S)	E3ZM-CR61-M1TJ	E3ZM-CR81-M1TJ
Diffuse reflective			1 m	E3ZM-CD62-M1TJ	E3ZM-CD82-M1TJ
BGS reflective			10 to 100 mm	E3ZM-CL61H-M1TJ	E3ZM-CL81H-M1TJ
			10 to 150 mm	E3ZM-CL62H-M1TJ	E3ZM-CL82H-M1TJ
			10 to 200 mm	E3ZM-CL64H-M1TJ	E3ZM-CL84H-M1TJ

* Separate the Sensor and Reflector by at least the distance given in parentheses.

E3Z Compact Photoelectric Sensor with Built-in Amplifier











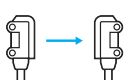

Sensing method	Appearance		Sensing distance	Model	
				NPN output	PNP output
Through-beam			15 m	E3Z-T61-M1TJ	E3Z-T81-M1TJ
Retro-reflective with MSR function			4 m ^{*2} [100 mm]	E3Z-R61-M1TJ	E3Z-R81-M1TJ
Diffuse reflective			5 to 100 mm (wide view)	---	E3Z-D81-M1TJ
			1 m	E3Z-D62-M1TJ	E3Z-D82-M1TJ
Narrow-beam reflective			90±30 mm	E3Z-L61-M1TJ	E3Z-L81-M1TJ

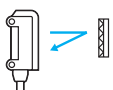
*1. The Reflector is sold separately. Select the Reflector model most suited to the application.

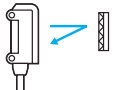
*2. The sensing distance specified is possible when the E39-R1S is used. Values in parentheses indicate the minimum required distance between the Sensor and Reflector.

E3T "Mini" Photoelectric Sensor with Built-in Amplifier

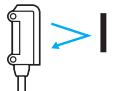
 Infrared light

Sensing method	Appearance		Sensing distance	Operating mode	Model	
					NPN output	PNP output
Through-beam		Side-view 	1 m	Light-ON	E3T-ST11-M1TJ	E3T-ST13-M1TJ
				Dark-ON	E3T-ST12-M1TJ	E3T-ST14-M1TJ
		300 mm	Light-ON	E3T-ST21-M1TJ	E3T-ST23-M1TJ	
			Dark-ON	E3T-ST22-M1TJ	E3T-ST24-M1TJ	
		Flat 	500 mm	Light-ON	E3T-FT11-M1TJ	E3T-FT13-M1TJ
			300 mm	Light-ON	E3T-FT21-M1TJ	E3T-FT23-M1TJ
			Dark-ON	E3T-FT22-M1TJ	E3T-FT24-M1TJ	
Retro-reflective		Side-view 	200 mm [10 mm] *	Light-ON	E3T-SR21-M1TJ	E3T-SR23-M1TJ
				Dark-ON	E3T-SR22-M1TJ	E3T-SR24-M1TJ
		Side-view 	100 mm [10 mm] *	Light-ON	E3T-SR31-M1TJ	E3T-SR33-M1TJ
				Dark-ON	E3T-SR32-M1TJ	E3T-SR34-M1TJ
Diffuse reflective		Flat 	5 to 30 mm	Light-ON	E3T-FD11-M1TJ	E3T-FD13-M1TJ
				Dark-ON	E3T-FD12-M1TJ	E3T-FD14-M1TJ
Convergent reflective		Side-view 	5 to 15 mm	Light-ON	E3T-SL11-M1TJ	E3T-SL13-M1TJ
				Dark-ON	E3T-SL12-M1TJ	E3T-SL14-M1TJ
			5 to 30 mm	Light-ON	E3T-SL21-M1TJ	E3T-SL23-M1TJ
				Dark-ON	E3T-SL22-M1TJ	E3T-SL24-M1TJ
BGS reflective		Flat 	1 to 15 mm	Light-ON	E3T-FL11-M1TJ	E3T-FL13-M1TJ
				Dark-ON	E3T-FL12-M1TJ	E3T-FL14-M1TJ
			1 to 30 mm	Light-ON	E3T-FL21-M1TJ	E3T-FL23-M1TJ
				Dark-ON	E3T-FL22-M1TJ	E3T-FL24-M1TJ

* Separate the Sensor and Reflector by at least the distance given in parentheses.



Proximity Sensors

Proximity Sensors with Oil-resistant Cables (PUR Cables)

Appearance	Sensing distance	Output configuration	Operating mode	Model	
 Shielded	M8	2 mm	2-Wire DC Polarity 1,4 Pin Specifications	NO	E2E-X2D1-M1TGJ-U
	M12	3 mm			E2E-X3D1-M1TGJ-U
	M18	7 mm			E2E-X7D1-M1TGJ-U
	M30	10 mm			E2E-X10D1-M1TGJ-U
	M8	2 mm	2-Wire DC Polarity 1,2 Pin Specifications	NC	E2E-X2D2-M1TGJ-U
	M12	3 mm			E2E-X3D2-M1TGJ-U
	M18	7 mm			E2E-X7D2-M1TGJ-U
	M30	10 mm			E2E-X10D2-M1TGJ-U

Note: Other models are also available that can be used with the Twist-and-Click Connectors. Ask your OMRON representative for details.

Standard Proximity Sensor (PVC Cable)

Appearance	Sensing distance	Output configuration	Operating mode	Model	
 Shielded	M8	2 mm	2-Wire DC Polarity 1,4 Pin Specifications	NO	E2E-X2D1-M1TGJ
	M12	3 mm			E2E-X3D1-M1TGJ
	M18	7 mm			E2E-X7D1-M1TGJ
	M30	10 mm			E2E-X10D1-M1TGJ
 Non-shielded	M12	8 mm	2-Wire DC Polarity 1,4 Pin Specifications	NO	E2E-X8MD1-M1TGJ
	M18	14 mm			E2E-X14MD1-M1TGJ
	M30	20 mm			E2E-X20MD1-M1TGJ

Note: Other models are also available that can be used with the Twist-and-Click Connectors. Ask your OMRON representative for details.

Spatter-Immune Proximity Sensor (Fire-retardant PVC Cable)

Appearance	Sensing distance	Output configuration	Operating mode	Model	
 Shielded	M12	3 mm	2-Wire DC Polarity 1,4 Pin Specifications	NO	E2EQ-X3D1-M1TGJ
	M18	7 mm			E2EQ-X7D1-M1TGJ
	M30	10 mm			E2EQ-X10D1-M1TGJ
	M12	4 mm	2-Wire DC Polarity 3,4 Pin Specifications	NO	E2EQ-X4X1-M1TJ
	M18	8 mm			E2EQ-X8X1-M1TJ
	M30	15 mm			E2EQ-X15X1-M1TJ

Note: Other models are also available that can be used with the Twist-and-Click Connectors. Ask your OMRON representative for details.

Proximity Sensor with All-stainless Housing (Fire-retardant PVC Cable)

Appearance	Sensing distance	Output configuration	Operating mode	Model	
 Shielded	M8	1.5 mm	2-Wire DC Polarity 1,4 Pin Specifications	NO	E2FM-X1R5D1-M1TGJ
	M12	2 mm			E2FM-X2D1-M1TGJ
	M18	5 mm			E2FM-X5D1-M1TGJ
	M30	10 mm			E2FM-X10D1-M1TGJ

Note: Other models are also available that can be used with the Twist-and-Click Connectors. Ask your OMRON representative for details.

Chip-Immune Inductive Proximity Sensor (PVC Cable)

Appearance		Sensing distance		Output configuration	Operating mode	Model
Shielded 	M12	2 mm		2-Wire DC Polarity 1,4 Pin Specifications	NO	E2EZ-X2D1-M1TGJ
	M18	4 mm				E2EZ-X4D1-M1TGJ
	M30	8 mm				E2EZ-X8D1-M1TGJ
	M12	2 mm		2-Wire DC Polarity 3,4 Pin Specifications	NO	E2EZ-X2D1-M1TJ
	M18	4 mm				E2EZ-X4D1-M1TJ
	M30	8 mm				E2EZ-X8D1-M1TJ

Note: Other models are also available that can be used with the Twist-and-Click Connectors. Ask your OMRON representative for details.

Pulse Response Proximity Sensor

Appearance		Sensing distance		Output configuration	Operating mode	Model
Shielded 	M12	4 mm		3-Wire DC PNP 1, 4, 3 Pin Specifications	NO	E2V-X4B1-M1TJ
	M18	8 mm				E2V-X8B1-M1TJ
	M30	15 mm				E2V-X15B1-M1TJ
	M12	4 mm		3-Wire DC NPN 1, 4, 3 Pin Specifications	NO	E2V-X4C1-M1TJ
	M18	8 mm				E2V-X8C1-M1TJ
	M30	15 mm				E2V-X15C1-M1TJ

Note: Other models are also available that can be used with the Twist-and-Click Connectors. Ask your OMRON representative for details.

Cable Amplifier Proximity Sensor

Appearance		Sensing distance		Output configuration	Operating mode	Model
Shielded 	3 dia.	0.8 mm		2-Wire DC Polarity 1,4 Pin Specifications	NO	E2EC-CR8D1-M1TGJ
	5.4 dia.	1.5 mm				E2EC-C1R5D1-M1TGJ
	8 dia.	3 mm				E2EC-C3D1-M1TGJ
	8 dia.	2 mm		2-Wire DC No polarity 3, 4 Pin Specifications	NO	E2EC-QC2D1-M1TGJ-T

Note: Other models are also available that can be used with the Twist-and-Click Connectors. Ask your OMRON representative for details.

READ AND UNDERSTAND THIS DOCUMENT

Please read and understand this document before using the products. Please consult your OMRON representative if you have any questions or comments.

WARRANTY

OMRON's exclusive warranty is that the products are free from defects in materials and workmanship for a period of one year (or other period if specified) from date of sale by OMRON.

OMRON MAKES NO WARRANTY OR REPRESENTATION, EXPRESS OR IMPLIED, REGARDING NON-INFRINGEMENT, MERCHANTABILITY, OR FITNESS FOR PARTICULAR PURPOSE OF THE PRODUCTS. ANY BUYER OR USER ACKNOWLEDGES THAT THE BUYER OR USER ALONE HAS DETERMINED THAT THE PRODUCTS WILL SUITABLY MEET THE REQUIREMENTS OF THEIR INTENDED USE. OMRON DISCLAIMS ALL OTHER WARRANTIES, EXPRESS OR IMPLIED.

LIMITATIONS OF LIABILITY

OMRON SHALL NOT BE RESPONSIBLE FOR SPECIAL, INDIRECT, OR CONSEQUENTIAL DAMAGES, LOSS OF PROFITS OR COMMERCIAL LOSS IN ANY WAY CONNECTED WITH THE PRODUCTS, WHETHER SUCH CLAIM IS BASED ON CONTRACT, WARRANTY, NEGLIGENCE, OR STRICT LIABILITY.

In no event shall responsibility of OMRON for any act exceed the individual price of the product on which liability is asserted.

IN NO EVENT SHALL OMRON BE RESPONSIBLE FOR WARRANTY, REPAIR, OR OTHER CLAIMS REGARDING THE PRODUCTS UNLESS OMRON'S ANALYSIS CONFIRMS THAT THE PRODUCTS WERE PROPERLY HANDLED, STORED, INSTALLED, AND MAINTAINED AND NOT SUBJECT TO CONTAMINATION, ABUSE, MISUSE, OR INAPPROPRIATE MODIFICATION OR REPAIR.

SUITABILITY FOR USE

THE PRODUCTS CONTAINED IN THIS DOCUMENT ARE NOT SAFETY RATED. THEY ARE NOT DESIGNED OR RATED FOR ENSURING SAFETY OF PERSONS, AND SHOULD NOT BE RELIED UPON AS A SAFETY COMPONENT OR PROTECTIVE DEVICE FOR SUCH PURPOSES. Please refer to separate catalogs for OMRON's safety rated products.

OMRON shall not be responsible for conformity with any standards, codes, or regulations that apply to the combination of products in the customer's application or use of the product.

At the customer's request, OMRON will provide applicable third party certification documents identifying ratings and limitations of use that apply to the products. This information by itself is not sufficient for a complete determination of the suitability of the products in combination with the end product, machine, system, or other application or use.

The following are some examples of applications for which particular attention must be given. This is not intended to be an exhaustive list of all possible uses of the products, nor is it intended to imply that the uses listed may be suitable for the products:

- Outdoor use, uses involving potential chemical contamination or electrical interference, or conditions or uses not described in this document.
- Nuclear energy control systems, combustion systems, railroad systems, aviation systems, medical equipment, amusement machines, vehicles, safety equipment, and installations subject to separate industry or government regulations.
- Systems, machines, and equipment that could present a risk to life or property.

Please know and observe all prohibitions of use applicable to the products.

NEVER USE THE PRODUCTS FOR AN APPLICATION INVOLVING SERIOUS RISK TO LIFE OR PROPERTY WITHOUT ENSURING THAT THE SYSTEM AS A WHOLE HAS BEEN DESIGNED TO ADDRESS THE RISKS, AND THAT THE OMRON PRODUCT IS PROPERLY RATED AND INSTALLED FOR THE INTENDED USE WITHIN THE OVERALL EQUIPMENT OR SYSTEM.

PERFORMANCE DATA

Performance data given in this document is provided as a guide for the user in determining suitability and does not constitute a warranty. It may represent the result of OMRON's test conditions, and the users must correlate it to actual application requirements. Actual performance is subject to the OMRON Warranty and Limitations of Liability.

CHANGE IN SPECIFICATIONS

Product specifications and accessories may be changed at any time based on improvements and other reasons.

It is our practice to change model numbers when published ratings or features are changed, or when significant construction changes are made. However, some specifications of the product may be changed without any notice. When in doubt, special model numbers may be assigned to fix or establish key specifications for your application on your request. Please consult with your OMRON representative at any time to confirm actual specifications of purchased products.

DIMENSIONS AND WEIGHTS

Dimensions and weights are nominal and are not to be used for manufacturing purposes, even when tolerances are shown.

ERRORS AND OMISSIONS

The information in this document has been carefully checked and is believed to be accurate; however, no responsibility is assumed for clerical, typographical, or proofreading errors, or omissions.

PROGRAMMABLE PRODUCTS

OMRON shall not be responsible for the user's programming of a programmable product, or any consequence thereof.

COPYRIGHT AND COPY PERMISSION

This document shall not be copied for sales or promotions without permission.

This document is protected by copyright and is intended solely for use in conjunction with the product. Please notify us before copying or reproducing this document in any manner, for any other purpose. If copying or transmitting this document to another, please copy or transmit it in its entirety.

Cat. No. G016-E1-02 **In the interest of product improvement, specifications are subject to change without notice.**

OMRON Corporation

Electronic Components Company

Connector Division

Sakado 3-2-1, Takatsu-ku, Kawasaki-city,
Kanagawa, 213-0012 Japan

Tel: (81)44-812-3432/Fax: (81)44-812-3447

Regional Headquarters

OMRON EUROPE B.V.

Sensor Business Unit,
Carl-Benz-Str. 4, D-71154 Nufringen,
Germany

Tel: (49)7032-811-0/Fax: (49)7032-811-199

OMRON ELECTRONICS LLC

1 East Commerce Drive, Schaumburg, IL 60173
U.S.A.

Tel: (1)847-843-7900/Fax: (1)847-843-8568

OMRON ASIA PACIFIC PTE. LTD.

83 Clemenceau Avenue,
#11-01, UE Square,
239920 Singapore

Tel: (65)6835-3011/Fax: (65)6835-2711

OMRON (CHINA) CO., LTD.

Room 2211, Bank of China Tower,
200 Yin Cheng Road (M),
Shanghai, 200120 China

Tel: (86)21-5037-2222/Fax: (86)21-5037-2200

Printed in Japan

1008