

SMD HP ▪ XI3030(2S)/EU Series



Features

- Top view white LED
- High luminous intensity output
- Typical Viewing Angle:120°
- Pb-free
- RoHS compliant

Description

The Everlight XI3030 package has high efficacy, high CRI, mid power consumption, wide viewing angle and a compact form factor. These features make this package an ideal LED for all lighting applications.

Applications

- General lighting
- Decorative and Entertainment Lighting
- Indicators
- Illumination

Table of Contents

Product Nomenclature.....	3
Absolute Maximum Ratings.....	4
PN of the XI3030 series: White LEDs.....	5
Reference Optic-Electrical Characteristic: Warm White LEDs.....	6
Reference Optic-Electrical Characteristic: Neutral White LEDs.....	7
Reference Optic-Electrical Characteristic: Cool White LEDs.....	8
Product Binning:Luminous Flux Bins.....	9
Product Binning:White Bin Structure.....	10
Product Binning:Warm White Bin Structure.....	11
Product Binning:Warm White Bin Coordinates.....	11
Product Binning: Neutral White Bin Structure.....	13
Product Binning: Neutral White Bin Coordinates.....	13
Product Binning:Cool White Bin Structure.....	14
Product Binning:Cool White Bin Coordinates.....	14
Suggestion of Color Bin Combination.....	16
Product Binning:Forward Voltage Bins.....	17
Mechanical Dimension.....	18
Wavelength Characteristics.....	19
Typical Electro-Optical Characteristic Curve.....	19
Emitter Tape Packaging.....	23
Emitter Reel Packaging.....	24
Precautions for Use.....	25
Storage Conditions.....	26
Revision History.....	27

Product Nomenclature

The product name is designated as below:

XI3030/ XK 3 C – X XX XX XX XX XXXX 1 Z15/ 2T/ EU

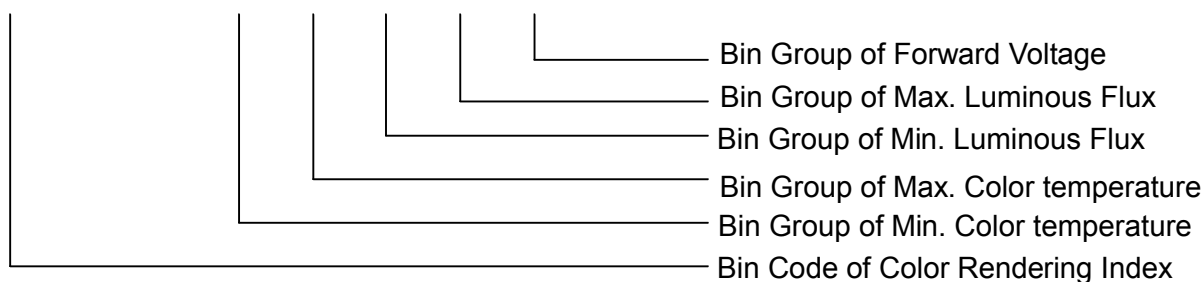

Table of Color Rendering Index

Symbol	Description
M	CRI(Min.) : 60
N	CRI(Min.) : 65
L	CRI(Min.) : 70
Q	CRI(Min.) : 75
K	CRI(Min.) : 80
P	CRI(Min.) : 85
H	CRI(Min.) : 90

Notes:

1. Tolerance of Color Rendering Index: ±2

Absolute Maximum Ratings

Parameter	Symbol	Ratings	Unit
Max. DC Forward Current (mA)	I_F	240	mA
Max. Peak Pulse Current (mA)	I_{Pulse}	300 ^[1]	mA
Power Dissipation	P_d	1	W
Thermal Resistance	R_{th}	15	°C/W
Max. Junction Temperature	T_J	115	°C
Operating Temperature	T_{Opr}	-40 ~ +85	°C
Storage Temperature	T_{Stg}	-40 ~ +100	°C
Max. Soldering Temperature	T_{Sol}	260	°C
Max. Allowable Reflow Cycles	n/a	2	cycles

Notes:

1. Duty cycle = 1/10@1KHZ



PN of the XI3030 series: White LEDs



Order Code of XI3030	Minimum Luminous Flux (lm)	Typical Luminous Flux (lm)	CCT (K) Wavelength (nm)	Forward Voltage (V)	Current (mA)	CRI (Min.)
XI3030/KK3C-H2727R7S358701Z15/2T/EU	90	101	2580-2870K	5.8~7.0	150	80
XI3030/KK3C-H3030R8S458701Z15/2T/EU	95	106	2870-3220K	5.8~7.0	150	80
XI3030/KK3C-H3535R8S458701Z15/2T/EU	95	107	3220-3710K	5.8~7.0	150	80
XI3030/KK3C-H4040R8S458701Z15/2T/EU	95	108	3710-4260K	5.8~7.0	150	80
XI3030/KK3C-H5050S1S558701Z15/2T/EU	100	113	4745-5310K	5.8~7.0	150	80
XI3030/KK3C-H5757S1S558701Z15/2T/EU	100	110	5310-6020K	5.8~7.0	150	80
XI3030/KK3C-H6565R8S458701Z15/2T/EU	95	106	6020-7050K	5.8~7.0	150	80

Notes:

1. Luminous flux measurement tolerance: $\pm 10\%$.
2. The data of luminous flux measured at thermal pad=25
3. Typical luminous flux or light output performance is operated within the condition guided by this datasheet.
4. The CRI value is based on the Everlight testing instrument.
5. CRI measurement tolerance: ± 2 .

Reference Optic-Electrical Characteristic: Warm White LEDs

Order Code of XI3030	Typ. Luminous Flux (lm)	CCT (K) Wavelength (nm)	Forward Voltage (V)	Current (mA)	CRI (Min.)
XI3030/KK3C-H2727R8S4S2Z15/2T	46	2580-2870K	5.8~7.0	65	80
	71			100	
	86			125	
	101			150	
	120			175	
	128			200	
XI3030/KK3C-H3030R8S4S2Z15/2T	49	2870-3220K	5.8~7.0	65	80
	74			100	
	90			125	
	106			150	
	126			175	
	135			200	
XI3030/KK3C-H3535R8S4S2Z15/2T	49	3220-3710K	5.8~7.0	65	80
	75			100	
	91			125	
	107			150	
	127			175	
	136			200	

Notes: All value are measured at IF=65 mA/100 mA/125mA/150 mA/175 mA/200 mA and reference only.

Reference Optic-Electrical Characteristic: Neutral White LEDs

Order Code of XI3030	Typ. Luminous Flux (lm)	CCT (K) Wavelength (nm)	Forward Voltage (V)	Current (mA)	CRI (Min.)
XI3030/KK3C-H4040R8S458701Z15/2T/EU	50	3710-4260K	5.8~7.0	65	80
	76			100	
	92			125	
	108			150	
	129			175	
	137			200	

Notes: All value are measured at IF=65 mA/100 mA/125mA/150 mA/175 mA/200 mA and reference only.

EVERLIGHT

Reference Optic-Electrical Characteristic: Cool White LEDs

Order Code of XI3030	Typ. Luminous Flux (lm)	CCT (K) Wavelength (nm)	Forward Voltage (V)	Current (mA)	CRI (Min.)
XI3030/KK3C-H5050S1S558701Z15/2 T/EU	52	4745-5310K	5.8~7.0	65	80
	79			100	
	96			125	
	113			150	
	134			175	
	144			200	
XI3030/KK3C-H5757S1S558701Z15/2 T/EU	51	5310-6020K	5.8~7.0	65	80
	77			100	
	94			125	
	110			150	
	131			175	
	140			200	
XI3030/KK3C-H6565R8S458701Z15/ 2T/EU	49	6020-7050K	5.8~7.0	65	80
	74			100	
	90			125	
	106			150	
	126			175	
	135			200	

Notes: All value are measured at IF=65 mA/100 mA/125mA/150 mA/175 mA/200 mA and reference only.

Product Binning
Luminous Flux Bins

Group	Bin	Minimum Photometric Flux (lm)	Maximum Photometric Flux (lm)
R	1	50.0	55.0
	2	55.0	60.0
	3	60.0	65.0
	4	65.0	70.0
	5	70.0	76.0
	6	76.0	83.0
	7	83.0	90.0
	8	1	90.0
	2	95.0	100.0

Group	Bin	Minimum Photometric Flux (lm)	Maximum Photometric Flux (lm)
S	1	100.0	110.0
	2	110.0	120.0
	3	120.0	130.0
	4	130.0	140.0
	5	140.0	150.0
	6	150.0	160.0
	7	160.0	170.0
	8	170.0	180.0



White Bin Structure

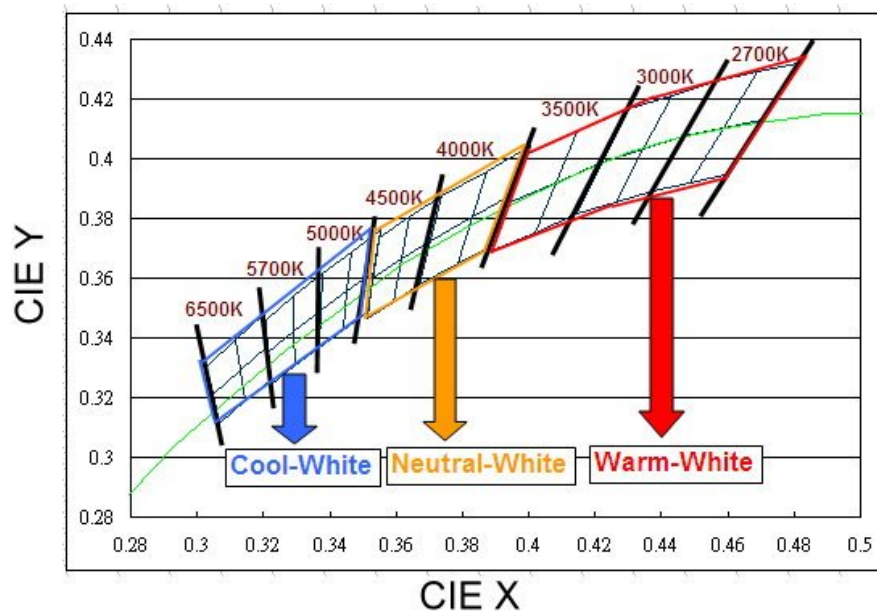

Chromaticity specification defined by ANSI

Notes:

1. The CCT range of Cool-White varies from 4745K to 7050K.
2. The CCT range of Neutral-White varies from 3710K to 4745K.
3. The CCT range of Warm-White varies from 2580K to 3710K.
4. Color coordinates measurement allowance : ± 0.01
5. Color bins are defined at $I_f=150\text{mA}$ operation

Warm-White Bin Structure

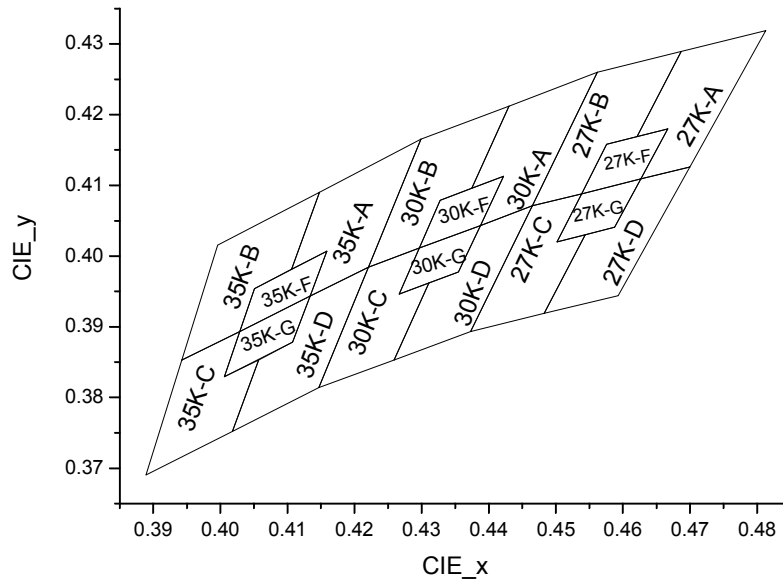

Warm-White Bin Coordinates

2700K

Bin	CIE X	CIE Y
27K-A	0.4813	0.4319
	0.4687	0.4289
	0.4621	0.4169
	0.4667	0.4180
	0.4627	0.4109
	0.4700	0.4126
Reference Range: 2580~2700K		

Bin	CIE X	CIE Y
27K-B	0.4687	0.4289
	0.4562	0.4260
	0.4465	0.4071
	0.4539	0.4088
	0.4576	0.4158
	0.4621	0.4169
Reference Range: 2700~2870K		

Bin	CIE X	CIE Y
27K-C	0.4465	0.4071
	0.4373	0.3893
	0.4483	0.3919
	0.4544	0.4030
	0.4502	0.4020
	0.4539	0.4088
Reference Range: 2700~2870K		

Bin	CIE X	CIE Y
27K-D	0.4700	0.4126
	0.4627	0.4109
	0.4588	0.4041
	0.4544	0.4030
	0.4483	0.3919
	0.4593	0.3944
Reference Range: 2580~2700K		

Bin	CIE X	CIE Y
27K-F	0.4667	0.4180
	0.4576	0.4158
	0.4539	0.4088
	0.4627	0.4109
Reference Range: 2680~2790K		

Bin	CIE X	CIE Y
27K-G	0.4627	0.4109
	0.4539	0.4088
	0.4502	0.4020
	0.4588	0.4041
Reference Range: 2680~2790K		

3000K

Bin	CIE X	CIE Y
30K-A	0.4562	0.4260
	0.4430	0.4212
	0.4375	0.4096
	0.4422	0.4113
	0.4388	0.4043
	0.4465	0.4071
Reference Range: 2870~3000K		

Bin	CIE X	CIE Y
30K-B	0.4430	0.4212
	0.4299	0.4165
	0.4221	0.3984
	0.4297	0.4011
	0.4328	0.4079
	0.4375	0.4096
Reference Range: 3000~3220K		

Bin	CIE X	CIE Y
30K-C	0.4221	0.3984
	0.4147	0.3814
	0.4259	0.3853
	0.4311	0.3962
	0.4267	0.3946
	0.4297	0.4011
Reference Range: 3000~3220K		

Bin	CIE X	CIE Y
30K-D	0.4465	0.4071
	0.4388	0.4043
	0.4355	0.3977
	0.4311	0.3962
	0.4259	0.3853
	0.4373	0.3893
Reference Range: 2870~3000K		

Bin	CIE X	CIE Y
30K-F	0.4422	0.4113
	0.4328	0.4079
	0.4297	0.4011
	0.4388	0.4043
Reference Range: 2960~3150K		

Bin	CIE X	CIE Y
30K-G	0.4388	0.4043
	0.4297	0.4011
	0.4267	0.3946
	0.4355	0.3977
Reference Range: 2960~3150K		

3500K

Bin	CIE X	CIE Y
35K-A	0.4299	0.4165
	0.4148	0.4090
	0.4106	0.3981
	0.4159	0.4007
	0.4134	0.3943
	0.4221	0.3984
Reference Range: 3220~3500K		

Bin	CIE X	CIE Y
35K-B	0.4148	0.4090
	0.3996	0.4015
	0.3943	0.3853
	0.4029	0.3893
	0.4051	0.3954
	0.4106	0.3981
Reference Range: 3500~3710K		

Bin	CIE X	CIE Y
35K-C	0.3943	0.3853
	0.3889	0.3690
	0.4018	0.3752
	0.4057	0.3853
	0.4006	0.3829
	0.4029	0.3893
Reference Range: 3500~3710K		

Bin	CIE X	CIE Y
35K-D	0.4221	0.3984
	0.4134	0.3943
	0.4108	0.3878
	0.4057	0.3853
	0.4018	0.3752
	0.4147	0.3814
Reference Range: 3220~3500K		

Bin	CIE X	CIE Y
35K-F	0.4159	0.4007
	0.4051	0.3954
	0.4029	0.3893
	0.4134	0.3943
Reference Range: 3370~3560K		

Bin	CIE X	CIE Y
35K-G	0.4134	0.3943
	0.4029	0.3893
	0.4006	0.3829
	0.4108	0.3878
Reference Range: 3370~3560K		

Note: Color coordinates measurement allowance : ±0.01.

Neutral-White Bin Structure

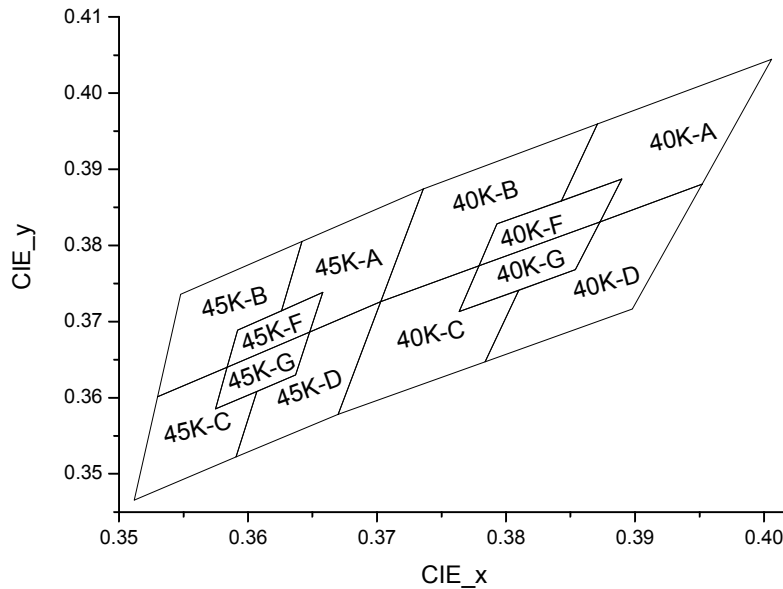

Neutral-White Bin Coordinates

4000K

Bin	CIE X	CIE Y
40K-A	0.4006	0.4044
	0.3871	0.3959
	0.3843	0.3858
	0.3890	0.3887
	0.3873	0.3831
	0.3952	0.3880
Reference Range: 3710~4000K		

Bin	CIE X	CIE Y
40K-B	0.3871	0.3959
	0.3736	0.3874
	0.3703	0.3726
	0.3779	0.3773
	0.3793	0.3828
	0.3843	0.3858
Reference Range: 4000~4260K		

Bin	CIE X	CIE Y
40K-C	0.3703	0.3726
	0.3670	0.3578
	0.3784	0.3647
	0.3810	0.3741
	0.3764	0.3713
	0.3779	0.3773
Reference Range: 4000~4260K		

Bin	CIE X	CIE Y
40K-D	0.3952	0.3880
	0.3873	0.3831
	0.3854	0.3768
	0.3810	0.3741
	0.3784	0.3647
	0.3898	0.3716
Reference Range: 3710~4000K		

Bin	CIE X	CIE Y
40K-F	0.3890	0.3887
	0.3793	0.3828
	0.3779	0.3773
	0.3873	0.3831
Reference Range: 3870~4080K		

Bin	CIE X	CIE Y
40K-G	0.3873	0.3831
	0.3779	0.3773
	0.3764	0.3713
	0.3854	0.3768
Reference Range: 3870~4080K		

Note: Color coordinates measurement allowance : ± 0.01 .

Cool-White Bin Structure

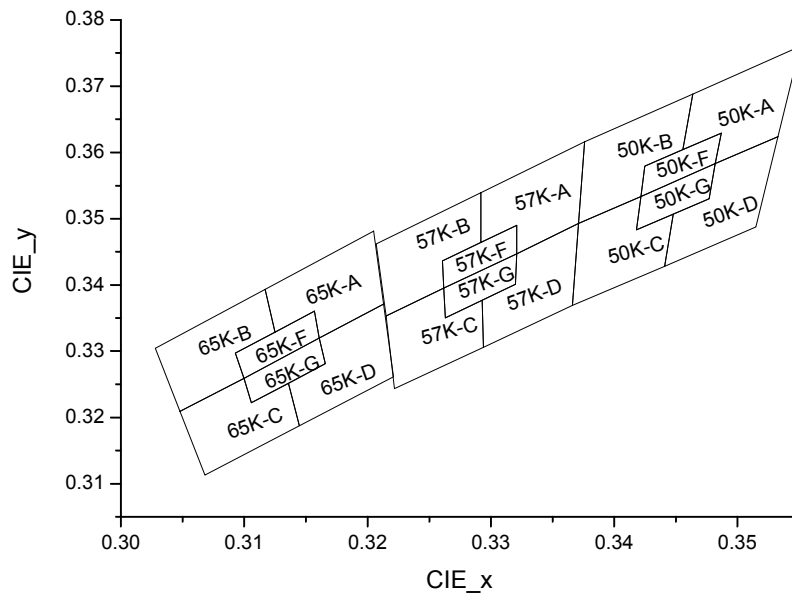

Cool-White Bin Coordinates

5000K

Bin	CIE X	CIE Y
50K-A	0.3551	0.3760
	0.3464	0.3688
	0.3456	0.3604
	0.3487	0.3629
	0.3482	0.3583
	0.3533	0.3624
Reference Range: 4745~5000K		

Bin	CIE X	CIE Y
50K-B	0.3464	0.3688
	0.3376	0.3616
	0.3371	0.3493
	0.3422	0.3533
	0.3425	0.3579
	0.3456	0.3604
Reference Range: 5000~5310K		

Bin	CIE X	CIE Y
50K-C	0.3371	0.3493
	0.3366	0.3369
	0.3441	0.3428
	0.3448	0.3507
	0.3418	0.3483
	0.3422	0.3533
Reference Range: 5000~5310K		

Bin	CIE X	CIE Y
50K-D	0.3533	0.3624
	0.3482	0.3583
	0.3477	0.3530
	0.3448	0.3507
	0.3441	0.3428
	0.3515	0.3487
Reference Range: 4745~5000K		

Bin	CIE X	CIE Y
50K-F	0.3487	0.3629
	0.3425	0.3579
	0.3422	0.3533
	0.3482	0.3583
Reference Range: 4900~5120K		

Bin	CIE X	CIE Y
50K-G	0.3482	0.3583
	0.3422	0.3533
	0.3418	0.3483
	0.3477	0.3530
Reference Range: 4900~5120K		

5700K

Bin	CIE X	CIE Y
57K-A	0.3376	0.3616
	0.3292	0.3539
	0.3292	0.3464
	0.3321	0.3490
	0.3321	0.3447
	0.3371	0.3493
Reference Range: 5310~5700K		

Bin	CIE X	CIE Y
57K-B	0.3292	0.3539
	0.3207	0.3462
	0.3215	0.3353
	0.3262	0.3395
	0.3261	0.3436
	0.3292	0.3464
Reference Range: 5700~6020K		

Bin	CIE X	CIE Y
57K-C	0.3215	0.3353
	0.3222	0.3243
	0.3294	0.3306
	0.3293	0.3377
	0.3263	0.3350
	0.3262	0.3395
Reference Range: 5700~6020K		

Bin	CIE X	CIE Y
57K-D	0.3371	0.3493
	0.3321	0.3447
	0.3320	0.3401
	0.3293	0.3377
	0.3294	0.3306
	0.3366	0.3369
Reference Range: 5310~5700K		

Bin	CIE X	CIE Y
57K-F	0.3321	0.3490
	0.3261	0.3436
	0.3262	0.3395
	0.3321	0.3447
Reference Range: 5510~5780K		

Bin	CIE X	CIE Y
57K-G	0.3321	0.3447
	0.3262	0.3395
	0.3263	0.3350
	0.3320	0.3401
Reference Range: 5510~5780K		

6500K

Bin	CIE X	CIE Y
65K-A	0.3205	0.3481
	0.3117	0.3393
	0.3125	0.3328
	0.3157	0.3360
	0.3161	0.3320
	0.3213	0.3371
Reference Range: 6020~6500K		

Bin	CIE X	CIE Y
65K-B	0.3117	0.3393
	0.3028	0.3304
	0.3048	0.3209
	0.3100	0.3259
	0.3093	0.3297
	0.3125	0.3328
Reference Range: 6500~7050K		

Bin	CIE X	CIE Y
65K-C	0.3048	0.3209
	0.3068	0.3113
	0.3145	0.3187
	0.3136	0.3251
	0.3106	0.3222
	0.3100	0.3259
Reference Range: 6500~7050K		

Bin	CIE X	CIE Y
65K-D	0.3213	0.3371
	0.3161	0.3320
	0.3166	0.3281
	0.3136	0.3251
	0.3145	0.3187
	0.3221	0.3261
Reference Range: 6020~6500K		

Bin	CIE X	CIE Y
65K-F	0.3157	0.3360
	0.3093	0.3297
	0.3100	0.3259
	0.3161	0.3320
Reference Range: 6300~6690K		

Bin	CIE X	CIE Y
65K-G	0.3161	0.3320
	0.3100	0.3259
	0.3106	0.3222
	0.3166	0.3281
Reference Range: 6300~6690K		

Note: Color coordinates measurement allowance : ±0.01.

Suggestion of Color Bin Combination

1. Each CCT Bin consists of 6 smaller bins designated as -A, -B, -C, -D, -F, and -G. For example, the 3000K consists of 30K-A, 30K-B, 30K-C, 30K-D, 30K-F, and 30K-G.
2. Any single CCT Bin is defined as inside 7-step Macadam Ellipse, and the combination of smaller -F and -G bins inside it are defined as inside 3-step Macadam Ellipse.
3. Through bin combination, it is possible to get a good color uniformity. Please refer to following combination rule for getting good color uniformity mentioned above:

Kit 1: To combine -A bin with -C bin with 1:1 mixing rate for approaching 3-step Macadam Ellipse
 Kit 2: To combine -B bin with -D bin with 1:1 mixing rate for approaching 3-step Macadam Ellipse
 Kit 3: To combine -F bin with -C or -D bin with 1:1 mixing rate for approaching 4-step Macadam Ellipse
 Kit 4: To combine -G bin with -A or -B bin with 1:1 mixing rate for approaching 4-step Macadam Ellipse
 Kit 5: -F or -G bin only will be inside 3-step Macadam Ellipse

An Example of 3000K Combination

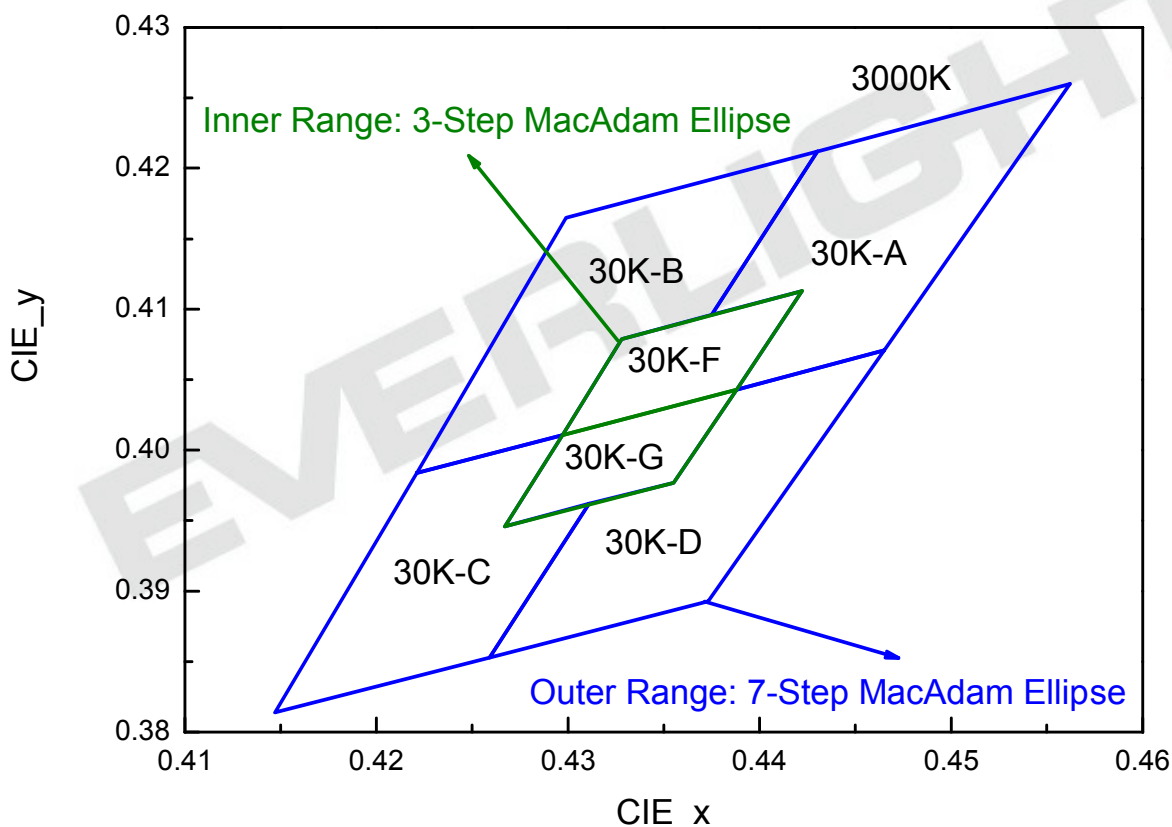

Note:

1. The percentage of each bin is determined by EVERLIGHT

Forward Voltage Bins

Bin		Minimum Forward Voltage (V)	Maximum Forward Voltage (V)
S2	5#8	5.80	5.90
	5#9	5.90	6.00
	6#0	6.00	6.10
	6#1	6.10	6.20
	6#2	6.20	6.30
	6#3	6.30	6.40
	6#4	6.40	6.50
	6#5	6.50	6.60
	6#6	6.60	6.70
	6#7	6.70	6.80
	6#8	6.80	6.90
6#9	6.90	7.00	

Notes:

1. Forward voltage measurement tolerance: $\pm 0.1V$.
2. Forward voltage bins are defined at $I_f=150mA$ operation.

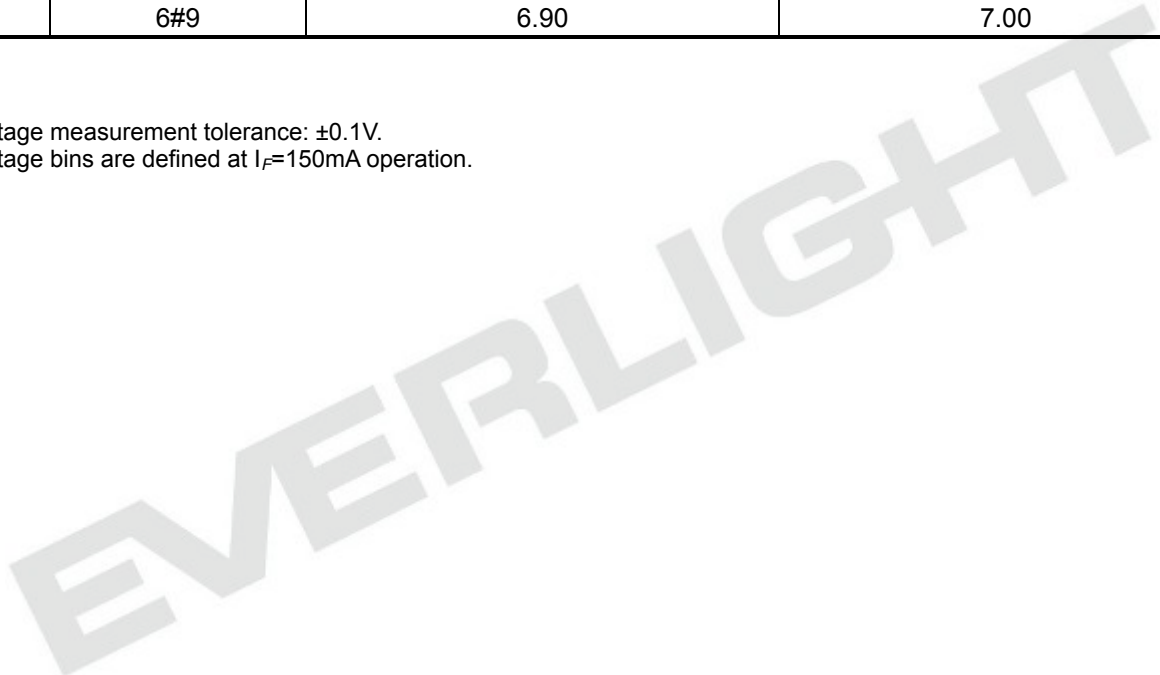

Mechanical Dimension

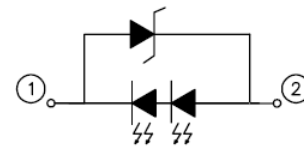
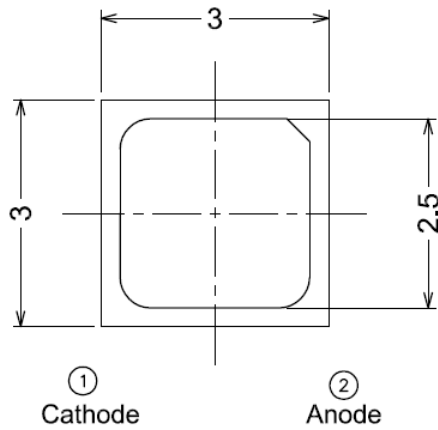

Polarity

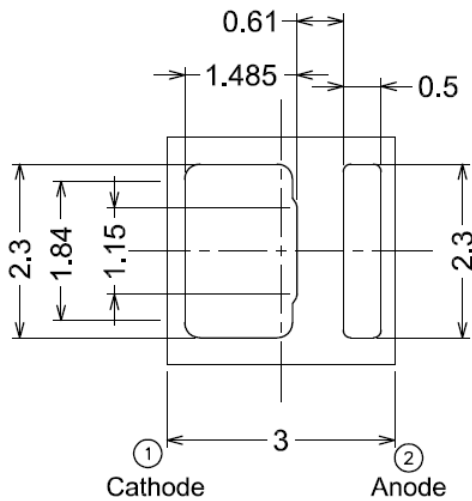
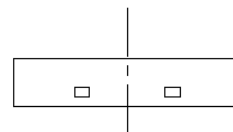
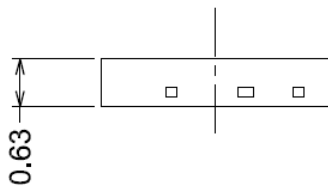

Bot. view

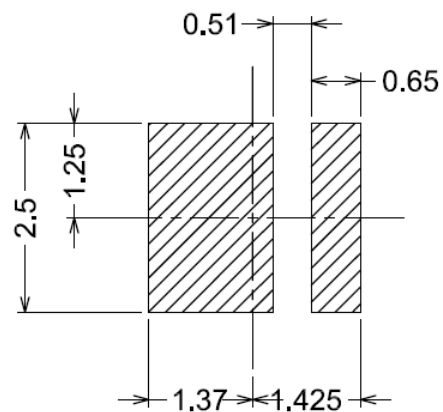

Soldering patterns

Notes:

1. Dimensions are in millimeters.
2. Tolerances unless mentioned are $\pm 0.2\text{mm}$.
3. The thermal pad is electrically unity from the Anode and contact pads.
4. Do not handle the device by the lens. Incorrect force applied to the lens may lead to the failure of devices.

Wavelength Characteristics

For Cool-White, Warm-White
Relative Spectral Distribution
@ Solder Pad Temperature = 25

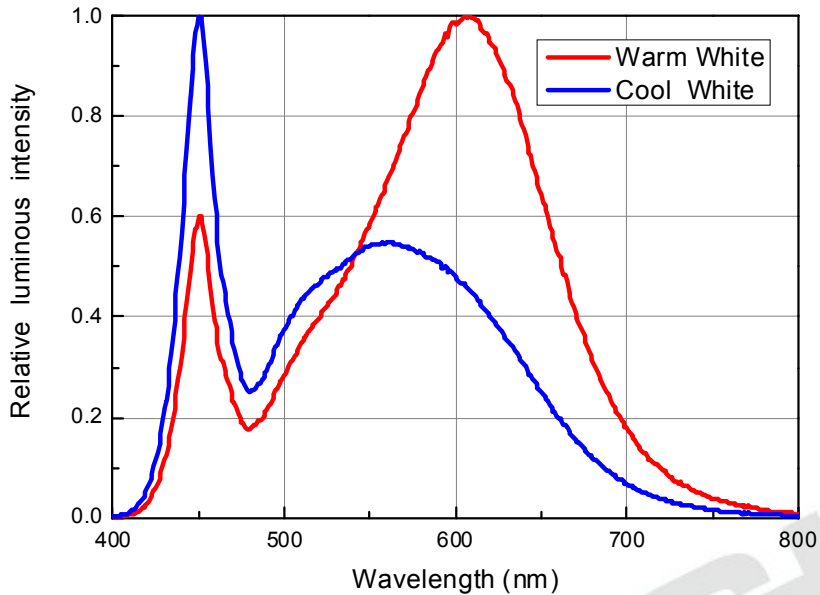

Typical Electrical Characteristics

For Cool-White, Warm-White
@ Solder Pad Temperature = 25

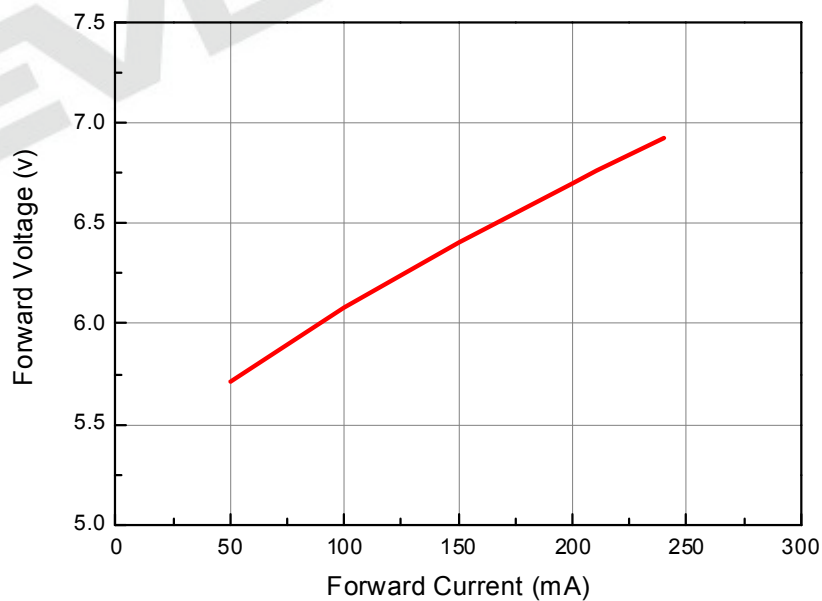

Typical Relative Luminous Flux vs. Forward Current

For Cool-White , Warm-White
@ Solder Pad Temperature = 25

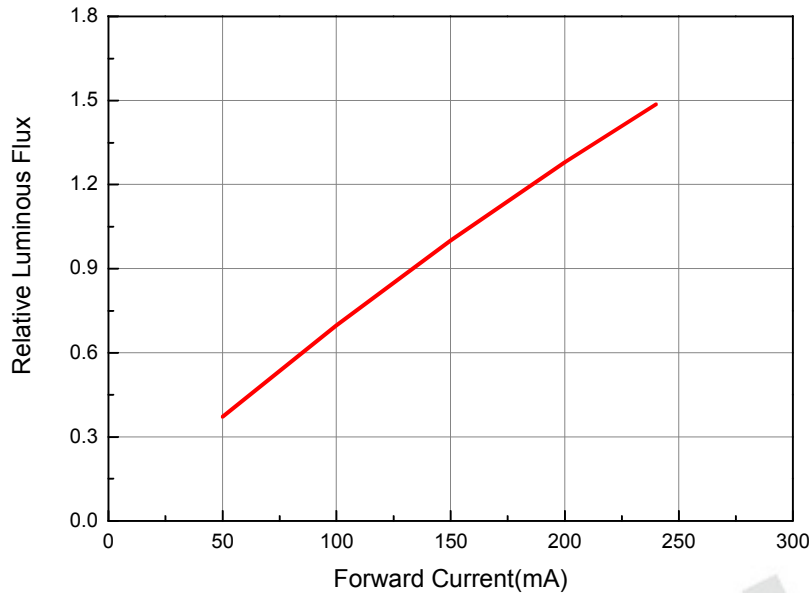

Typical Wavelength & Color Shift Characteristics vs. Forward Current

For Cool-White , Warm-White
@ Solder Pad Temperature = 25

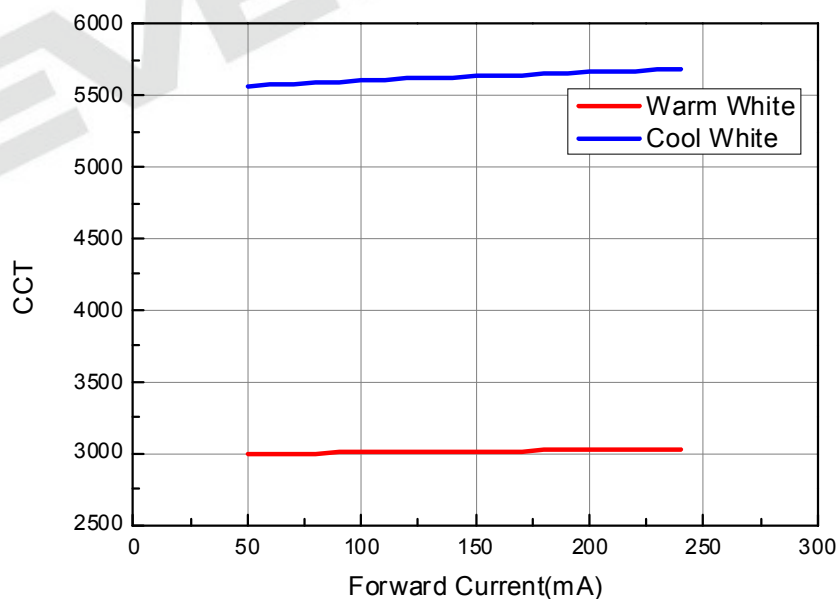

Relative Luminous Flux vs. Soldering Temperature @Forward Current = 150mA

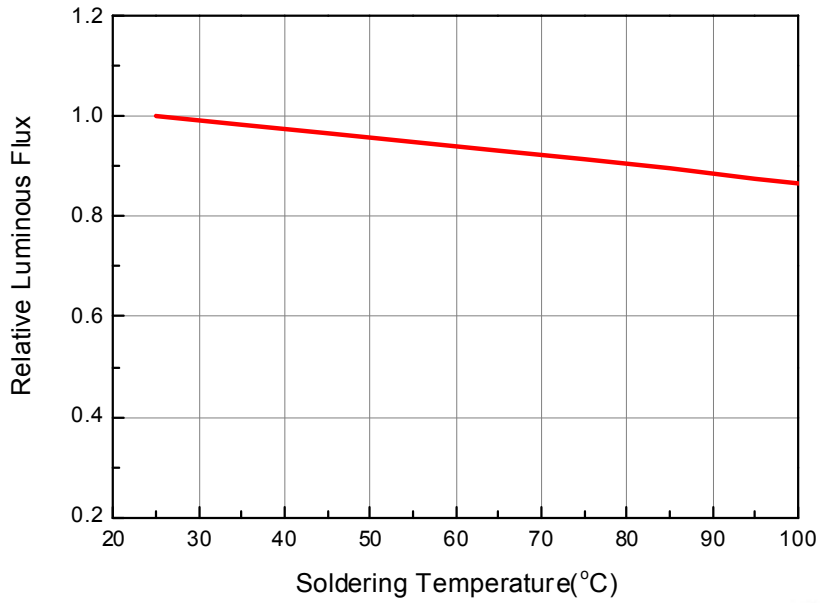

Forward Voltage vs. Soldering Temperature @ Forward Current = 150mA

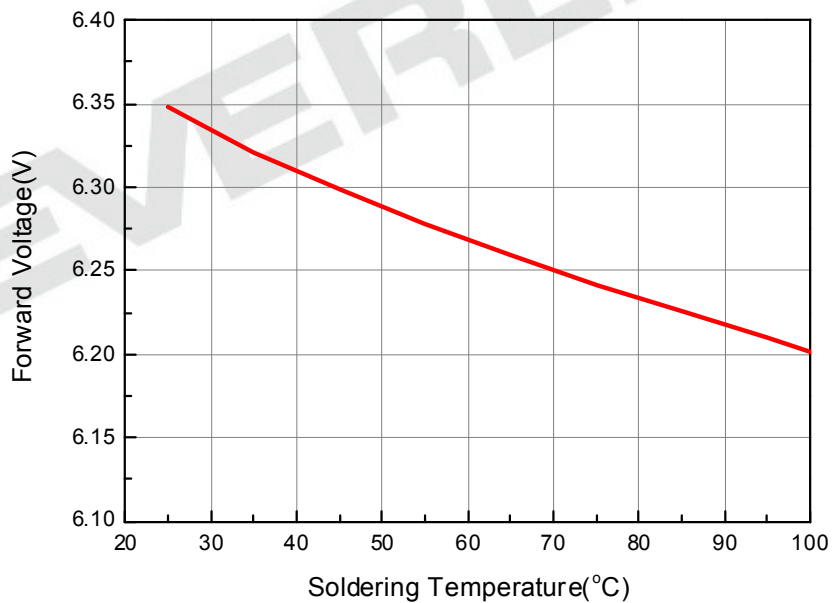

Forward Current Derating Curve @ Junction Temperature <115

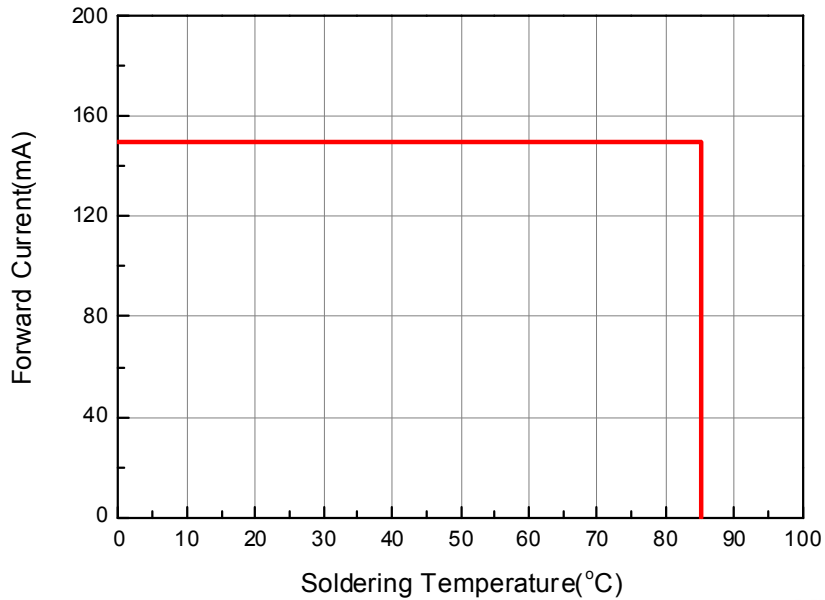

Typical Radiation Patterns XI3030 series: Typical Diagram Characteristics of Radiation for Warm-White and Cool-White

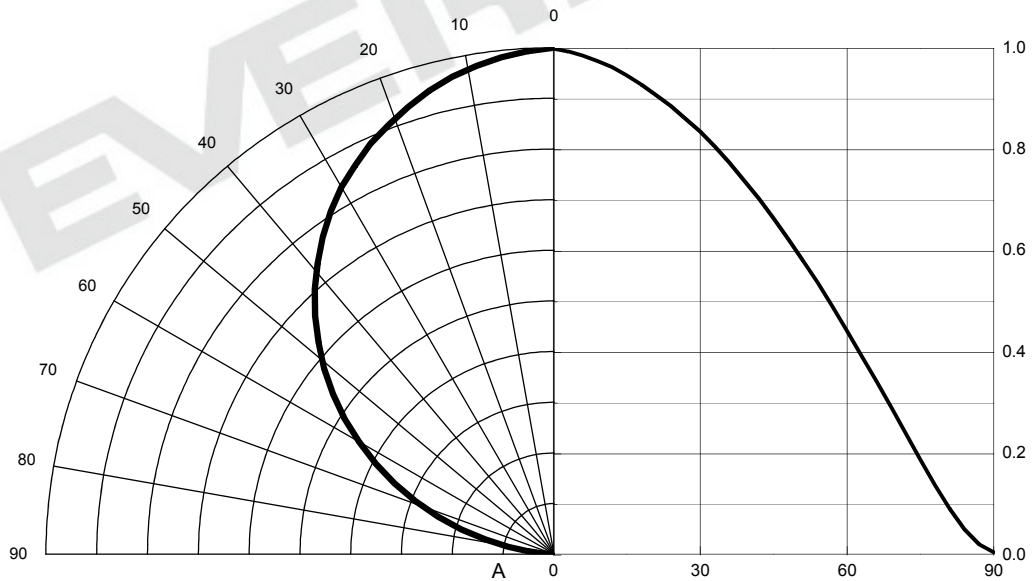

Notes:

1. $2\theta_{1/2}$ is the off axis angle from lamp centerline where the luminous intensity is 1/2 of the peak value.
2. View angle tolerance is $\pm 5^\circ$.

Emitter Tape Packaging

Carrier Tape Dimensions as the following:

Reel:2000pcs

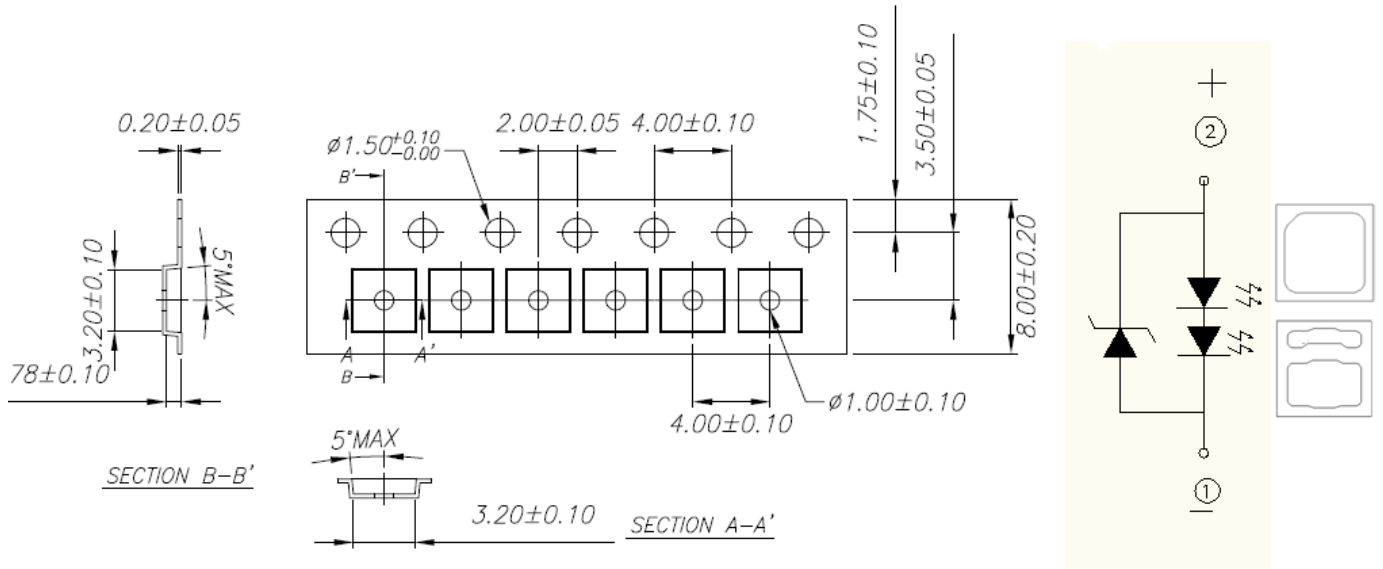

Notes:

1. Tolerance unless mentioned is ± 0.1 mm; Unit = mm
2. Minimum packing amount is 250/500/1000/2000 pcs per reel

Moisture Resistant Packaging

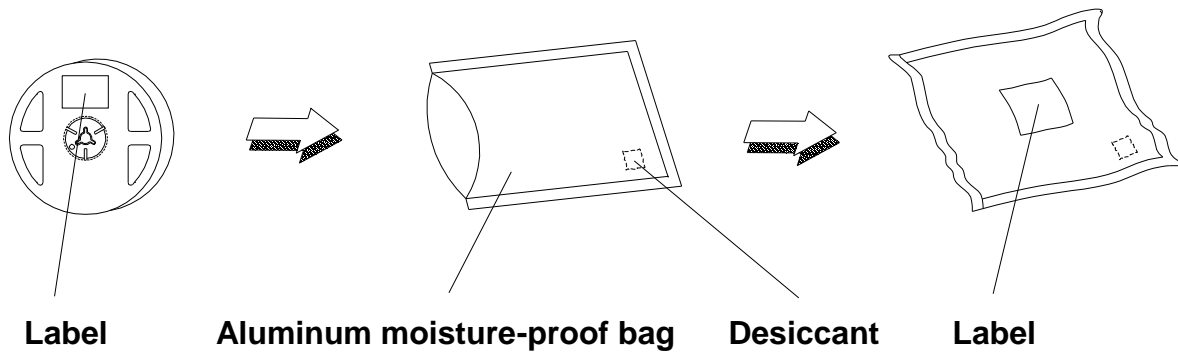

Emitter Reel Packaging

Reel Dimensions

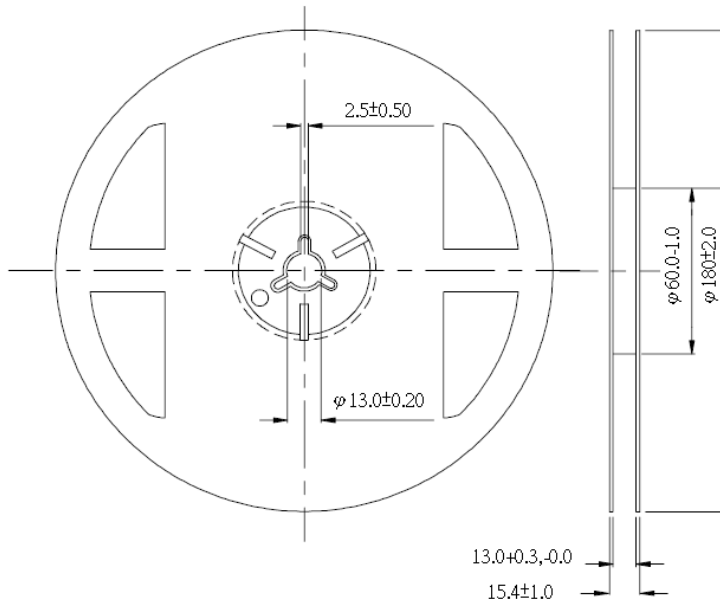

Notes:

1. Dimensions are in millimeters.
2. Tolerances unless mentioned are ± 0.1 mm.

Product Labeling

Label Explanation

CPN: Customer Specification (when required)

P/N : Everlight Production Number

QTY: Packing Quantity

CAT: Luminous Flux (Brightness) Bin

HUE: Color Bin

REF: Forward Voltage Bin

LOT No: Lot Number

MADE IN TAIWAN: Production Place



Precautions for Use

1. Over-current-proof

Customer must apply resistors for protection; otherwise slight voltage shift will cause big current change (Burn out will happen).

2. Storage

2.1 Before the package is opened: The LEDs should be stored at 30°C or less and 50%RH or less after being shipped from Everlight. The storage life is 6 months. If the LEDs are to be stored for more than 6 months, they should be stored in a sealed container with a nitrogen atmosphere and moisture absorbent material.

2.2 After opening the package: The LED's should be stored under 30°C or less and 30%RH or less. The LED should be used within 168hrs (7days) after opening the package. If unused LEDs remain, they should be stored in moisture proof packages.

2.3 Before using LEDs: The LEDs should be baked under the following conditions: pre-curing at 60±5°C for 24 hours.

2.4 Do not stack assemblies containing Everlight XI3030 LEDs to prevent damage to the optical surface of LEDs. Forces applied to the optical surface may result in the surface being damaged.

3. Soldering Condition

3.1 Pb-free solder temperature profile

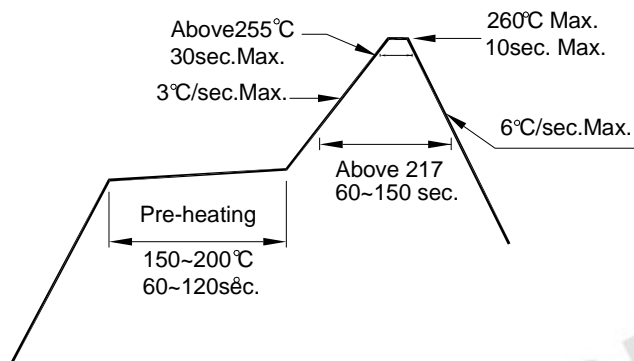

3.2 Reflow soldering should not be done more than two times.

3.3 When soldering, do not put stress on the LEDs during heating.

3.4 After soldering, do not warp the circuit board.

4. Soldering Iron

Each terminal is to go to the tip of soldering iron temperature less than 350°C for 3 seconds within once in less than the soldering iron capacity 25W. Leave two seconds and more intervals, and do soldering of each terminal. Be careful because the damage of the product is often started at the time of the hand solder.

5. Repairing

Repair should not be done after the LEDs have been soldered. When repairing is unavoidable, a double-head soldering iron should be used (as below figure). It should be confirmed beforehand whether the characteristics of the LEDs will or will not be damaged by repairing.

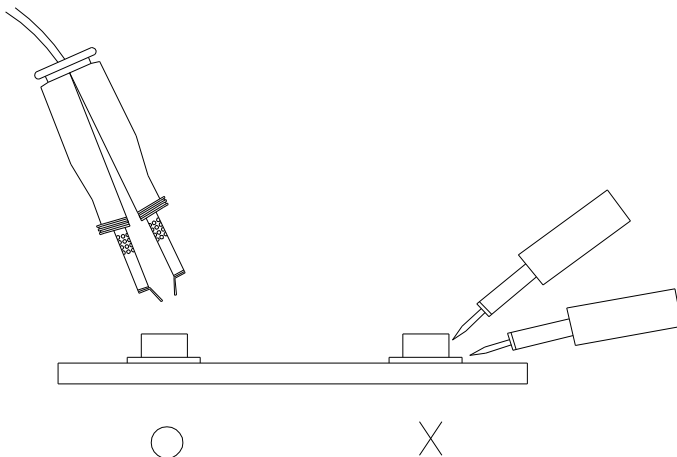

Storage Conditions

- Before the package is opened. The LEDs should be stored at 30°C or less and 85%RH or less after being shipped from Everlight and the storage life limits are 1 year. The LEDs can be stored up to 3 years If in a sealed container with a nitrogen atmosphere and moisture absorbent material.
- After opening the package: The LED's floor life is 1 year under 30 °C or less and 60%RH or less. The LED should be soldered with 168hrs (7days) after opening the package. If unused LEDs remain, it should be stored in moisture proof packages.
- If the moisture absorbent material (silica gel) has faded away or the LEDs have exceeded the storage time, baking treatment should be performed using the following conditions. Baking treatment: 60±5 °C for 24 hours.

EVERLIGHT

Revision History

Current version: Jul.24.2014
Issue No: DSE-0011274
Version: 2
Created by:Alun Hu

Page	Subjects (major change in previous version)	Date of change
	Created New Bin 2700K、 3500K	Jul.24.2014

EVERLIGHT