

HFD3

SUBMINIATURE SIGNAL RELAY



File No.:E133481



File No.:40018867

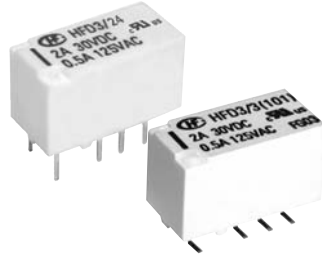

Features

- High dielectric withstand voltage of 2000VAC (between coil and contacts)
- Surge withstand voltage up to 2500VAC, meets FCC Part 68 and Telecordia
- Meets EN60950 / EN41003
- SMT and DIP types available
- Bifurcated contacts
- Single side stable and latching type available
- Environmental friendly product (RoHS compliant)
- Outline Dimensions: (15.0 x 7.5 x 9.0) mm

CONTACT DATA

Contact arrangement	2C
Contact resistance	50mΩ (at 0.1A 6VDC)
Contact material	AgNi + Au plated
Contact rating (Res. load)	2A 30VDC 0.5A 125VAC
Max. switching power	62.5VA / 60W
Max. switching voltage	250VAC / 220VDC
Max. switching current	2A
Min. applicable load	10mV 10μA
Mechanical endurance	1 x 10 ⁸ OPS
Electrical endurance	5 x 10 ⁵ OPS (at 1A 30VDC)
	1 x 10 ⁵ OPS (at 2A 30VDC)
	1 x 10 ⁵ OPS (at 0.5A 125VAC)

COIL

Coil power	Single side stable	140mW
	1 coil latching	100mW
	2 coils latching	200mW
Temperature rise		50K max.

CHARACTERISTICS

Insulation resistance		1000MΩ (at 500VDC)
Dielectric strength	Between coil & contacts	2000VAC 1min
	Between open contacts	1000VAC 1min
	Between contact sets	1500VAC 1min
Surge withstand voltage		
Between open contacts (10×160μs)		1500VAC (FCC part 68)
Between coil & contacts (2×10μs)		2500VAC (Telecordia)
Operate time (Set time)		4ms max.
Release time (Reset time)		4ms max.
Ambient temperature		-40°C to 85°C
Humidity		35% to 85% RH
Vibration resistance	Functional	10Hz to 55Hz 3.3mm DA
	Destructive	10Hz to 55Hz 5.0mm DA
Shock resistance	Functional	750m/s ² (75g)
	Destructive	1000m/s ² (100g)
Termination		DIP, SMT
Unit weight		Approx. 2g
Construction		Wash tight

Notes: The data shown above are initial values.

SAFETY APPROVAL RATINGS

UL&CUR	2A 30VDC
	0.5A 125VAC
VDE	2A 30VDC
	0.5A 125VAC

Notes: Only some typical ratings are listed above. If more details are required, please contact us.



HONGFA RELAY

ISO9001、ISO/TS16949、ISO14001、OHSAS18001 CERTIFIED

2007 Rev. 2.00

COIL DATA

at 23°C

Single side stable

Order Number	Nominal Voltage VDC	Pick-up Voltage VDC	Drop-out Voltage VDC	Coil Resistance Ω	Nominal Power mW	Max. Allowable Voltage VDC
HFD3/1.5	1.5	1.13	0.15	16 x (1 \pm 10%)	140	2.2
HFD3/3	3	2.25	0.3	64.3 x (1 \pm 10%)	140	4.5
HFD3/4.5	4.5	3.38	0.45	145 x (1 \pm 10%)	140	6.7
HFD3/5	5	3.75	0.5	178 x (1 \pm 10%)	140	7.5
HFD3/6	6	4.5	0.6	257 x (1 \pm 10%)	140	9
HFD3/9	9	6.75	0.9	579 x (1 \pm 10%)	140	13.5
HFD3/12	12	9	1.2	1028 x (1 \pm 10%)	140	18
HFD3/24	24	18	2.4	4114 x (1 \pm 10%)	140	36
HFD3/48	48	36	4.8	8533 x (1 \pm 10%)	270	57.6

1 coil latching

Order Number	Nominal Voltage VDC	Set Voltage VDC	Reset Voltage VDC	Coil Resistance Ω	Nominal Power mW	Max. Allowable Voltage VDC
HFD3/1.5-L1	1.5	1.13	1.13	22.5 x (1 \pm 10%)	100	2.7
HFD3/3-L1	3	2.25	2.25	90 x (1 \pm 10%)	100	5.4
HFD3/4.5-L1	4.5	3.38	3.38	203 x (1 \pm 10%)	100	8.1
HFD3/5-L1	5	3.75	3.75	250 x (1 \pm 10%)	100	9
HFD3/6-L1	6	4.5	4.5	360 x (1 \pm 10%)	100	10.8
HFD3/9-L1	9	6.75	6.75	810 x (1 \pm 10%)	100	16.2
HFD3/12-L1	12	9	9	1440 x (1 \pm 10%)	100	21.6
HFD3/24-L1	24	18	18	5760 x (1 \pm 10%)	100	43.2

2 coil latching

Order Number	Nominal Voltage VDC	Set Voltage VDC	Reset Voltage VDC	Coil Resistance Ω	Nominal Power mW	Max. Allowable Voltage VDC
HFD3/1.5-L2	1.5	1.13	1.13	11.2 x (1 \pm 10%)	200	2.2
HFD3/3-L2	3	2.25	2.25	45 x (1 \pm 10%)	200	4.5
HFD3/4.5-L2	4.5	3.38	3.38	101 x (1 \pm 10%)	200	6.7
HFD3/5-L2	5	3.75	3.75	125 x (1 \pm 10%)	200	7.5
HFD3/6-L2	6	4.5	4.5	180 x (1 \pm 10%)	200	9.0
HFD3/9-L2	9	6.75	6.75	405 x (1 \pm 10%)	200	13.5
HFD3/12-L2	12	9	9	720 x (1 \pm 10%)	200	18
HFD3/24-L2	24	18	18	2880 x (1 \pm 10%)	200	36

Notes: When user's requirements can't be found in the above table, please counsel with Hongfa for relay application support.

ORDERING INFORMATION

Type	HFD3 / 24	-L2	S	R	(XXX)
Coil voltage	1.5, 3, 4.5, 5, 6, 9, 12, 24, 48VDC ¹⁾				
Sort	L1: 1 coil latching	L2: 2 coils latching	Nil: Single side stable		
Terminal type	S: SMT	Nil: DIP			
Packing style	R: Tape and reel packing (Only for SMT type)		Nil: Tube packing		
Customer special code	(Only for special requirements)				

Notes: 1) 48VDC coil voltage is only for single side stable version.
2) HFD3 is also RoHS compliant.

OUTLINE DIMENSIONS, WIRING DIAGRAM AND PC BOARD LAYOUT

Unit: mm

Outline Dimensions
(DIP type)

Single side stable & 1 coil latching

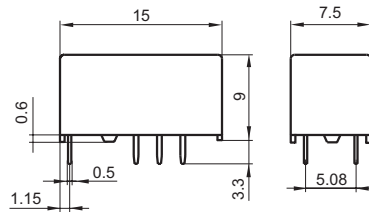

2 coils latching

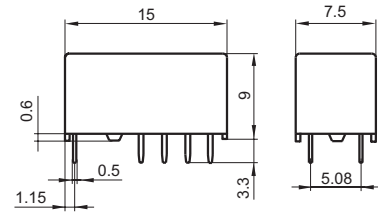

PCB Layout
(DIP type)
(Bottom view)

Single side stable & 1 coil latching

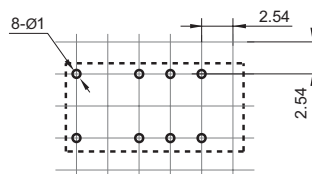

2 coils latching

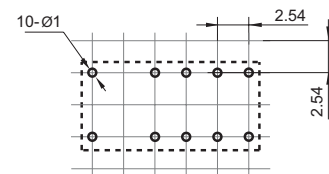

OUTLINE DIMENSIONS, WIRING DIAGRAM AND PC BOARD LAYOUT

Unit: mm

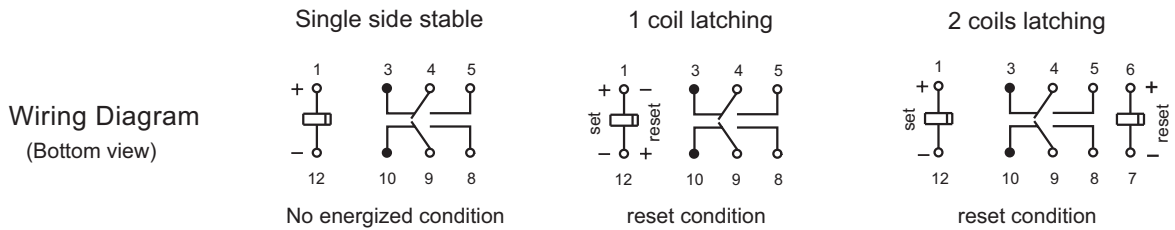
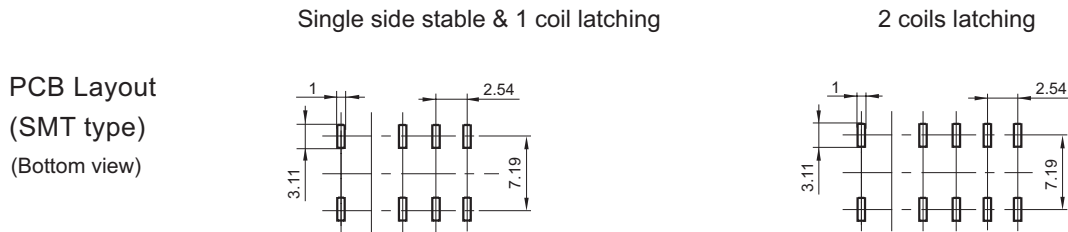
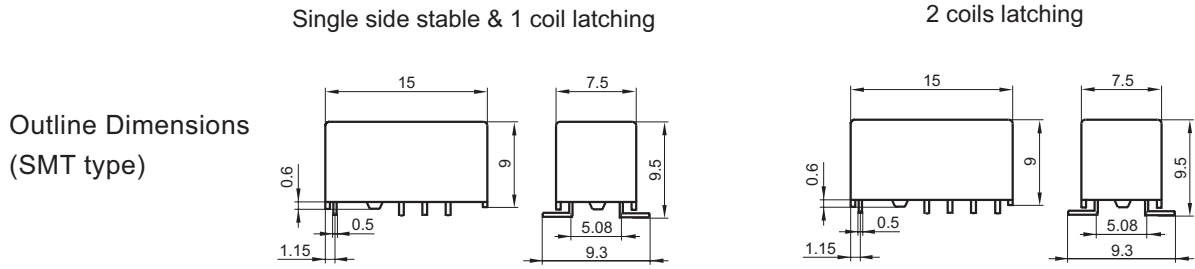

Notice

- Relay is on the "reset" status when being released from stock, with the consideration of shock risen from transit and relay mounting, relay would be changed to "set" status, therefore, when application (connecting the power supply), please reset the relay to "set" or "reset" status on request.
- In order to maintain "set" or "reset" status, energized voltage to coil should reach the rated voltage, impulse width should be 5 times more than "set" or "reset" time. Do not energize voltage to "set" coil and "reset" coil simultaneously. And also long energized.

TAPE PACKING

Unit: mm

Direction of Relay Insertion

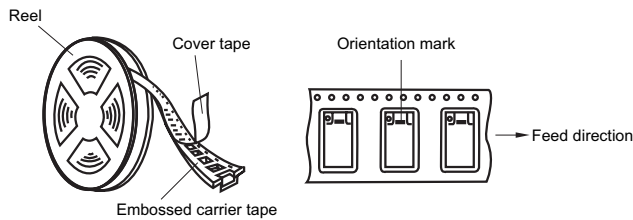

Reel Dimensions

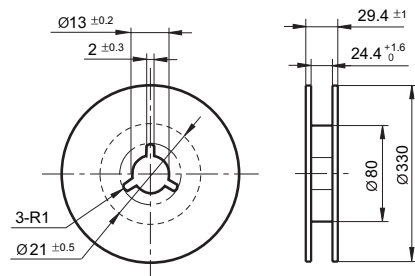

- Notes:**
- 1) Packing: 400pcs/reel, 5 reels/carton.
 - 2) MOQ for reel packing is 800pcs.

Tape Dimensions

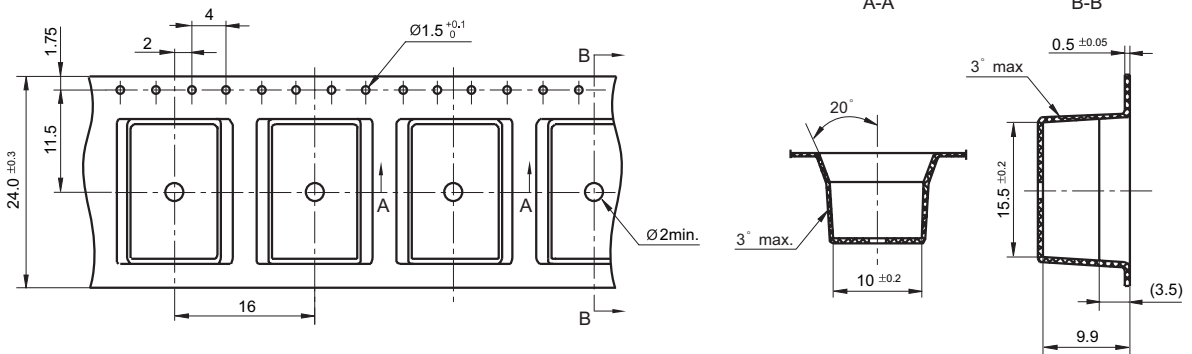

- Remark: 1) In case of no tolerance shown in outline dimension: outline dimension ≤1mm, tolerance should be ±0.2mm; outline dimension >1mm and ≤5mm, tolerance should be ±0.3mm; outline dimension >5mm, tolerance should be ±0.4mm.
 2) The tolerance without indicating for PCB layout is always ±0.1mm.
 3) The width of the gridding is 2.54mm.

CHARACTERISTIC CURVES

MAXIMUM SWITCHING POWER

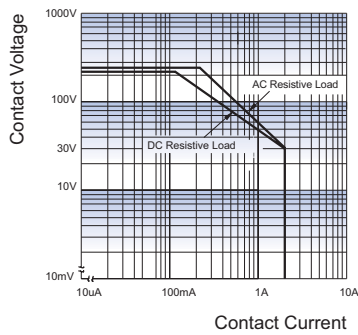

ENDURANCE CURVE

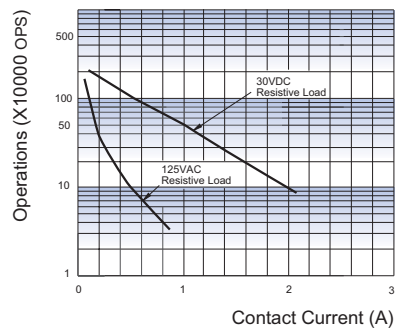

Disclaimer

This datasheet is for the customers' reference. All the specifications are subject to change without notice. We could not evaluate all the performance and all the parameters for every possible application. Thus the user should be in a right position to choose the suitable product for their own application. If there is any query, please contact Hongfa for the technical service. However, it is the user's responsibility to determine which product should be used only.