

# SKM 300GB126D



**SEMITRANS® 3**

## Trench IGBT Module

**SKM 300GB126D**

Preliminary Data

### Features

- Trench = Trenchgate technology
- $V_{CEsat}$  with positive temperature coefficient
- High short circuit capability, self limiting to  $6 \times I_C$

### Typical Applications

- Electronic welders
- AC inverter drives
- UPS

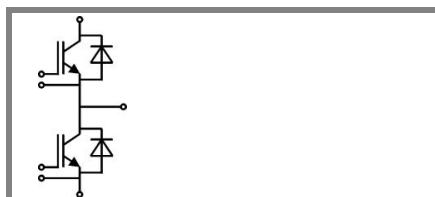

**GB**

Absolute Maximum Ratings		$T_c = 25^\circ\text{C}$ , unless otherwise specified		
Symbol	Conditions	Values		Units
<b>IGBT</b>				
$V_{CES}$	$T_j = 25^\circ\text{C}$	1200		V
$I_C$	$T_j = 150^\circ\text{C}$	$T_{case} = 25^\circ\text{C}$	310	A
		$T_{case} = 80^\circ\text{C}$	200	A
$I_{CRM}$	$I_{CRM} = 2 \times I_{Cnom}$	400		A
$V_{GES}$		$\pm 20$		V
$t_{psc}$	$V_{CC} = 600\text{ V}; V_{GE} \leq 20\text{ V}; T_j = 125^\circ\text{C}$ $V_{CES} < 1200\text{ V}$	10		$\mu\text{s}$
<b>Inverse Diode</b>				
$I_F$	$T_j = 150^\circ\text{C}$	$T_{case} = 25^\circ\text{C}$	250	A
		$T_{case} = 80^\circ\text{C}$	170	A
$I_{FRM}$	$I_{FRM} = 2 \times I_{Fnom}$	400		A
<b>Module</b>				
$I_{t(RMS)}$		500		A
$T_{vj}$		- 40 ... + 150		$^\circ\text{C}$
$T_{stg}$		-40...+125		$^\circ\text{C}$
$V_{isol}$	AC, 1 min.	4000		V

Characteristics		$T_c = 25^\circ\text{C}$ , unless otherwise specified			
Symbol	Conditions	min.	typ.	max.	Units
<b>IGBT</b>					
$V_{GE(th)}$	$V_{GE} = V_{CE}; I_C = 8\text{ mA}$	5	5,8	6,5	V
$I_{CES}$	$V_{GE} = 0\text{ V}; V_{CE} = V_{CES}$		$T_j = 25^\circ\text{C}$ 0,1	$T_j = 25^\circ\text{C}$ 0,3	$T_j = 125^\circ\text{C}$ mV
$V_{CE0}$			$T_j = 25^\circ\text{C}$ 1	$T_j = 125^\circ\text{C}$ 1,2	V
			0,9	1,1	V
$r_{CE}$	$V_{GE} = 15\text{ V}$		$T_j = 25^\circ\text{C}$ 3,5	$T_j = 125^\circ\text{C}$ 4,7	$m\Omega$
			5,5	6,8	$m\Omega$
$V_{CE(sat)}$	$I_{Cnom} = 200\text{ A}; V_{GE} = 15\text{ V}$		$T_j = 25^\circ\text{C}_{chiplev.}$ 1,7	$T_j = 125^\circ\text{C}_{chiplev.}$ 2,15	V
			2	2,45	V
$C_{ies}$	$V_{CE} = 25; V_{GE} = 0\text{ V}$		15		nF
$C_{oes}$			1,2		nF
$C_{res}$			1,1		nF
$Q_G$	$V_{GE} = -8\text{ V} - +20\text{ V}$		1800		nC
$R_{Gint}$	$T_j = 25^\circ\text{C}$		3,8		$\Omega$
$t_{d(on)}$	$R_{Gon} = 1,5\ \Omega$	$V_{CC} = 600\text{ V}$ $I_{Cnom} = 200\text{ A}$	280		ns
$t_r$			37		ns
$E_{on}$	$R_{Goff} = 1,5\ \Omega$	$T_j = 125^\circ\text{C}$ $V_{GE} = \pm 15\text{ V}$	21		mJ
$t_{d(off)}$			560		ns
$t_f$			100		ns
$E_{off}$			33		mJ
$R_{th(j-c)}$	per IGBT		0,12		K/W



**SEMITRANS® 3**

## Trench IGBT Module

**SKM 300GB126D**

Preliminary Data

### Features

- Trench = Trenchgate technology
- $V_{CEsat}$  with positive temperature coefficient
- High short circuit capability, self limiting to  $6 \times I_c$

### Typical Applications

- Electronic welders
- AC inverter drives
- UPS

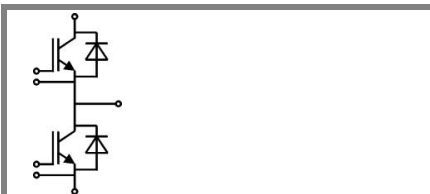

**GB**

### Characteristics

Symbol	Conditions	min.	typ.	max.	Units
<b>Inverse diode</b>					
$V_F = V_{EC}$	$I_{Fnom} = 200 \text{ A}; V_{GE} = 0 \text{ V}$				
	$T_j = 25 \text{ }^\circ\text{C}_{chiplev.}$		1,6	1,8	V
	$T_j = 125 \text{ }^\circ\text{C}_{chiplev.}$		1,6	1,8	V
$V_{F0}$					
	$T_j = 25 \text{ }^\circ\text{C}$		1	1,1	V
	$T_j = 125 \text{ }^\circ\text{C}$		0,8	0,9	V
$r_F$					
	$T_j = 25 \text{ }^\circ\text{C}$		3	3,5	mΩ
	$T_j = 125 \text{ }^\circ\text{C}$		4	4,5	mΩ
$I_{RRM}$	$I_{Fnom} = 200 \text{ A}$		290		A
$Q_{rr}$	$di/dt = 6200 \text{ A}/\mu\text{s}$		44		μC
$E_{off}$	$V_{GE} = -15 \text{ V}; V_{CC} = 600 \text{ V}$		18		mJ
$R_{th(j-c)D}$	per diode			0,25	K/W
<b>Module</b>					
$L_{CE}$			15	20	nH
$R_{CC'+EE'}$	res., terminal-chip	$T_{case} = 25 \text{ }^\circ\text{C}$	0,35		mΩ
		$T_{case} = 125 \text{ }^\circ\text{C}$	0,5		mΩ
$R_{th(c-s)}$	per module			0,038	K/W
$M_s$	to heat sink M6		3	5	Nm
$M_t$	to terminals M6		2,5	5	Nm
w				325	g

This is an electrostatic discharge sensitive device (ESDS), international standard IEC 60747-1, Chapter IX.

This technical information specifies semiconductor devices but promises no characteristics. No warranty or guarantee expressed or implied is made regarding delivery, performance or suitability.

# SKM 300GB126D

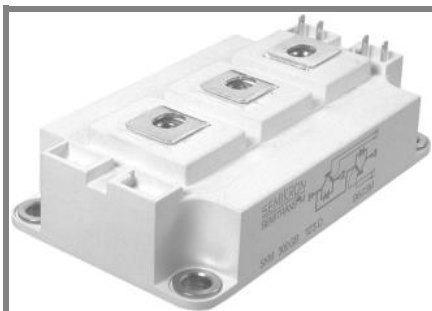

**SEMITRANS® 3**

## Trench IGBT Module

**SKM 300GB126D**

Preliminary Data

### Features

- Trench = Trenchgate technology
- $V_{CEsat}$  with positive temperature coefficient
- High short circuit capability, self limiting to  $6 \times I_c$

### Typical Applications

- Electronic welders
- AC inverter drives
- UPS

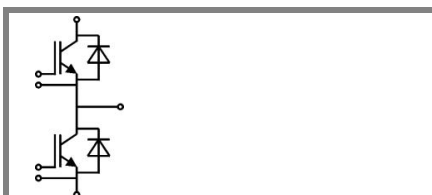

**GB**

$Z_{th}$		Conditions	Values	Units
<b>Symbol</b>				
$Z_{th(j-c)I}$				
$R_{\theta j-c}$	$i = 1$		80	mk/W
$R_{\theta j-c}$	$i = 2$		30	mk/W
$R_{\theta j-c}$	$i = 3$		8,5	mk/W
$R_{\theta j-c}$	$i = 4$		1,5	mk/W
$\tau_{\theta j-c}$	$i = 1$		0,0576	s
$\tau_{\theta j-c}$	$i = 2$		0,01	s
$\tau_{\theta j-c}$	$i = 3$		0,002	s
$\tau_{\theta j-c}$	$i = 4$		0,0002	s
$Z_{th(j-c)D}$				
$R_{\theta j-c}$	$i = 1$		150	mk/W
$R_{\theta j-c}$	$i = 2$		75	mk/W
$R_{\theta j-c}$	$i = 3$		22	mk/W
$R_{\theta j-c}$	$i = 4$		3	mk/W
$\tau_{\theta j-c}$	$i = 1$		0,0331	s
$\tau_{\theta j-c}$	$i = 2$		0,0113	s
$\tau_{\theta j-c}$	$i = 3$		0,0012	s
$\tau_{\theta j-c}$	$i = 4$		0,001	s

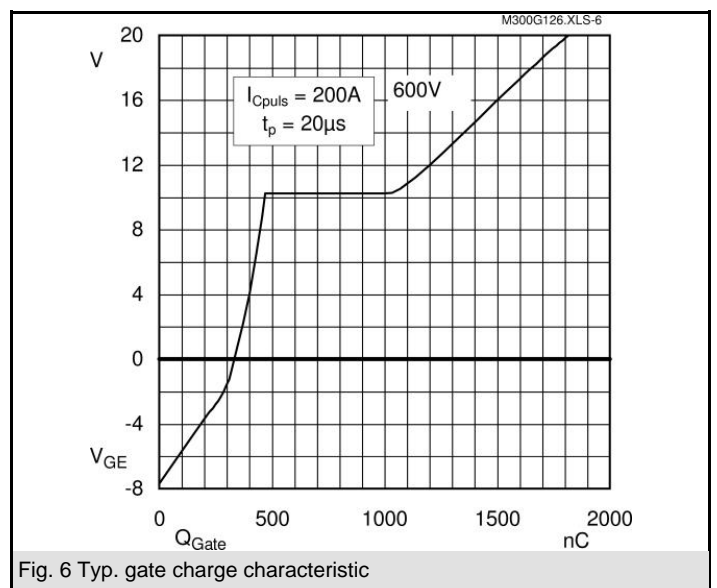
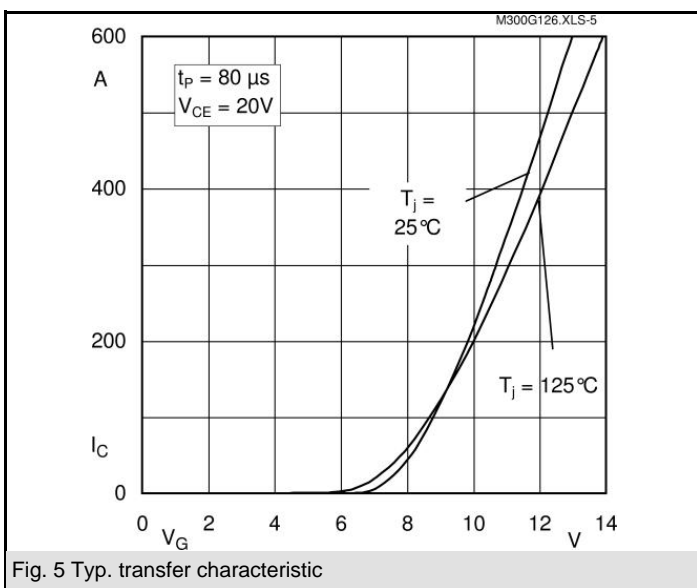
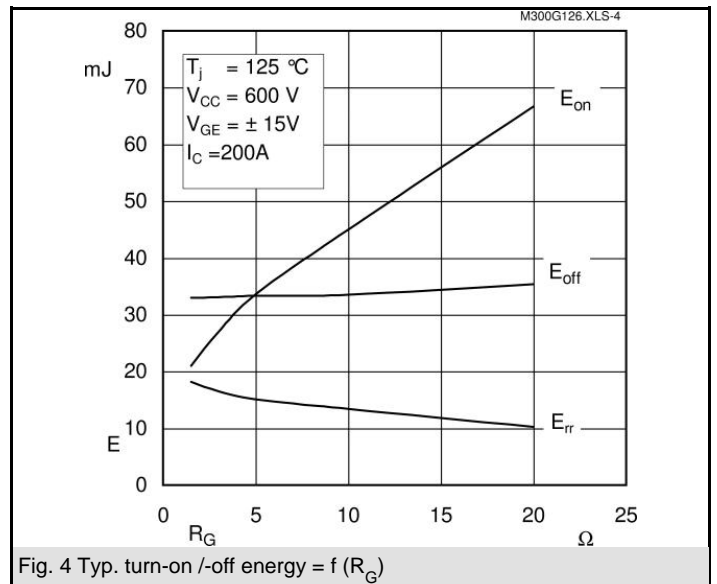
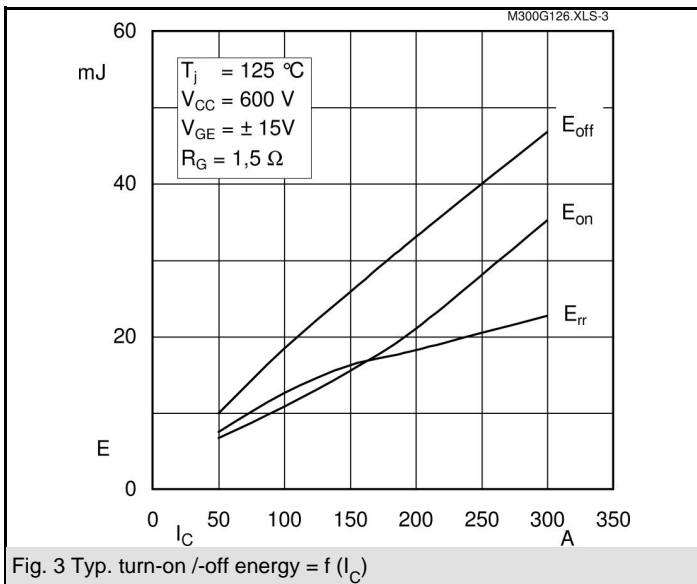
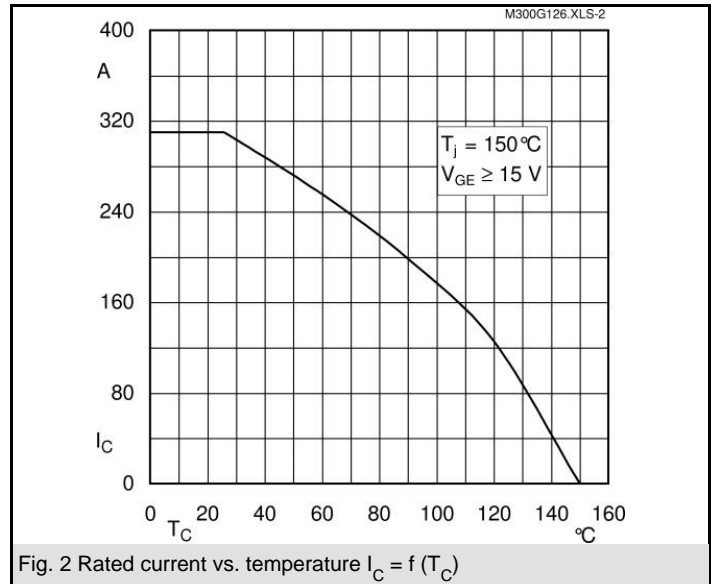
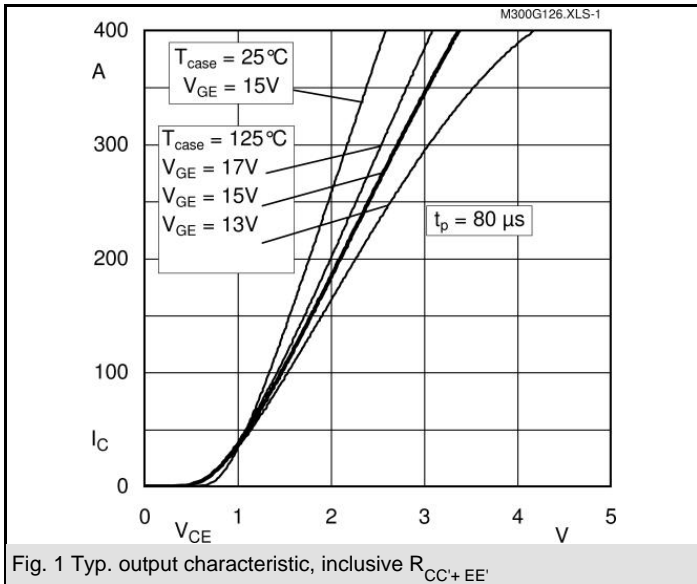

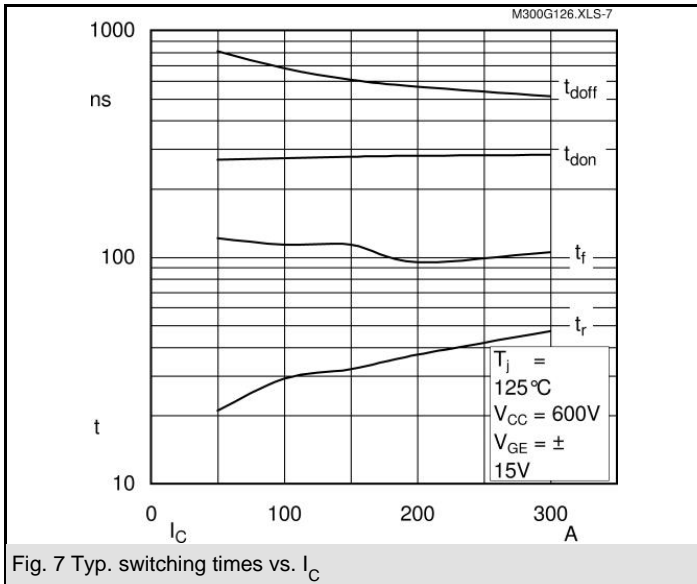

Fig. 7 Typ. switching times vs.  $I_C$

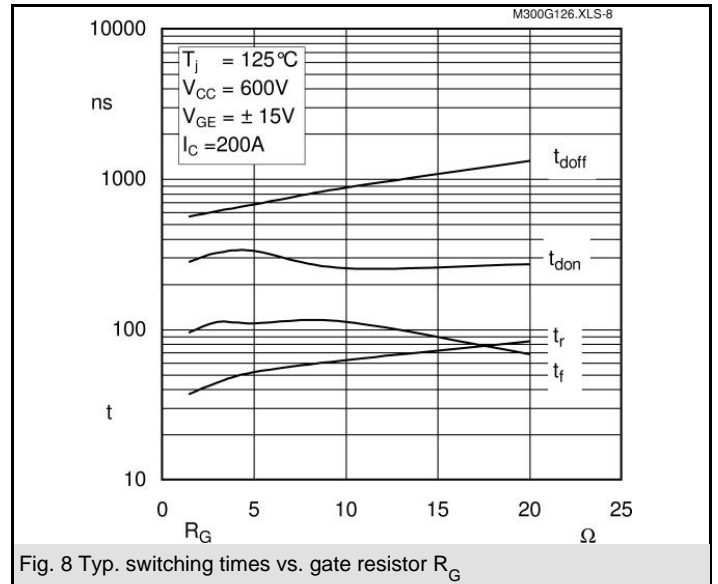

Fig. 8 Typ. switching times vs. gate resistor  $R_G$

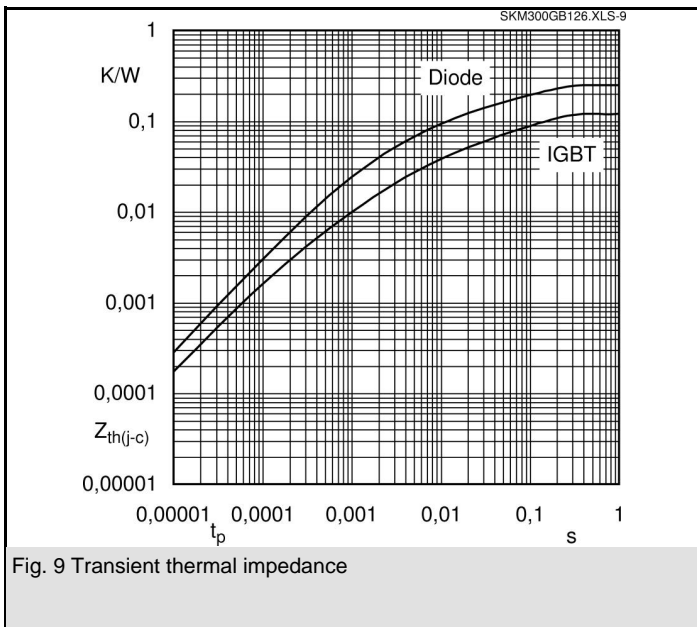

Fig. 9 Transient thermal impedance

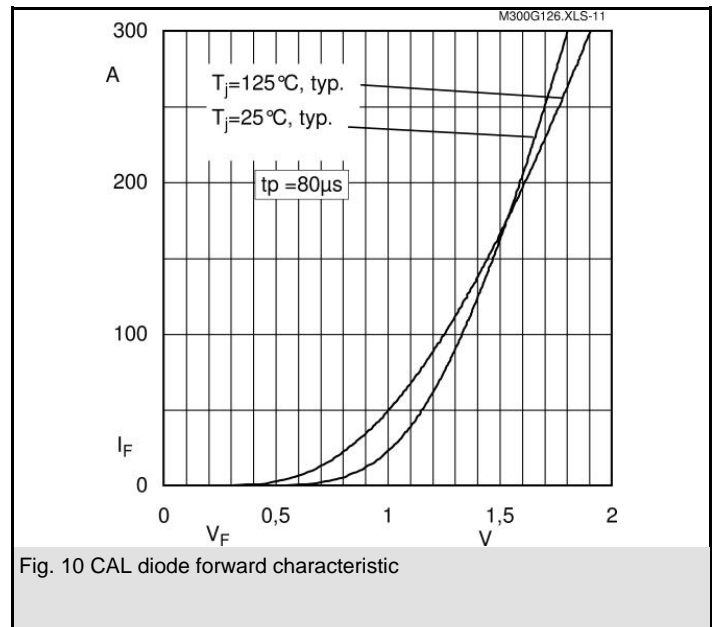

Fig. 10 CAL diode forward characteristic

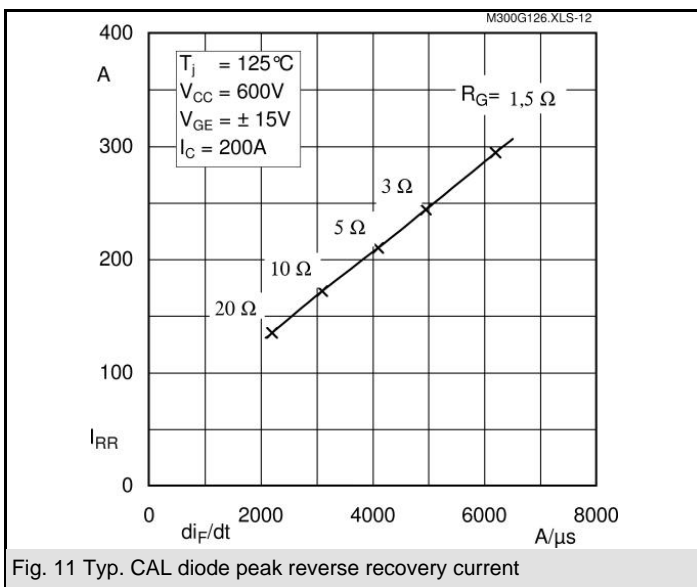

Fig. 11 Typ. CAL diode peak reverse recovery current

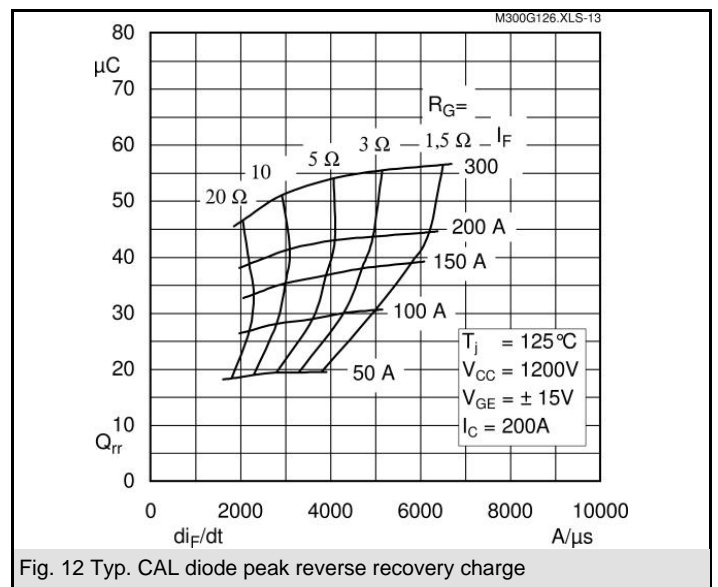

Fig. 12 Typ. CAL diode peak reverse recovery charge

# SKM 300GB126D

UL Recognized  
File no. E 63 532

Dimensions in mm

CASED56

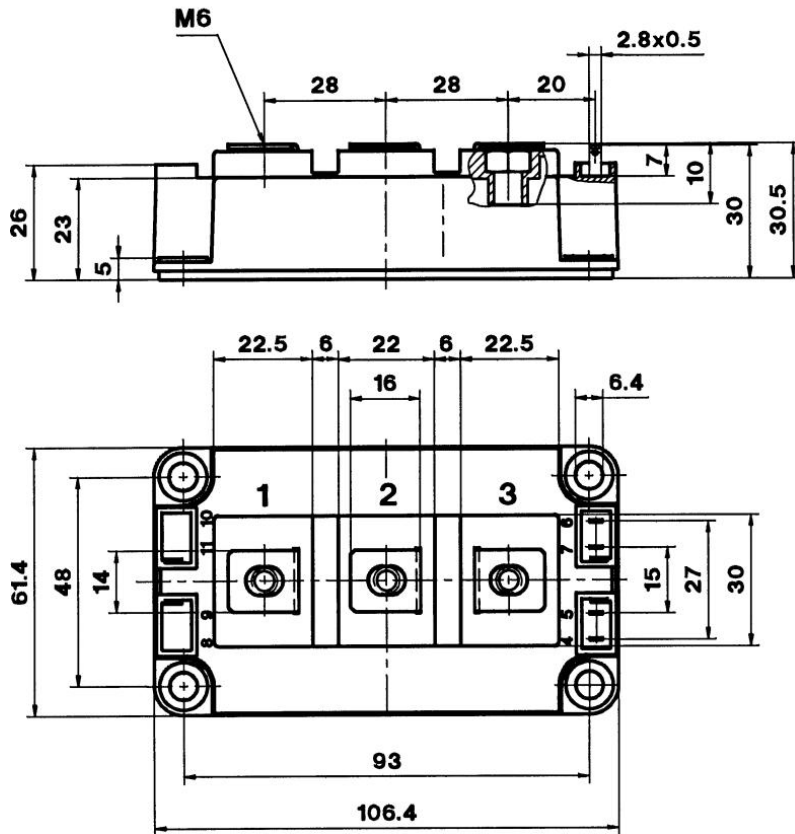

Case D 56

