

RKU 12- and 19-Pole

M23, Control Cable, Straight, Female, 12- and 19-Pole with Halogen Free LumFlex black PUR cable.

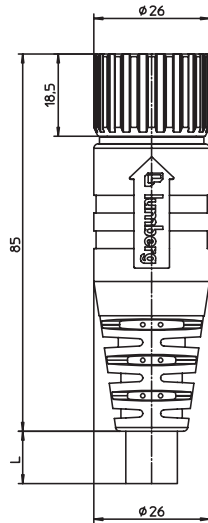

RKWU 12- and 19-Pole

M23, Control Cable, Right-Angle, Female, 12- and 19-Pole with Halogen Free LumFlex black PUR cable.

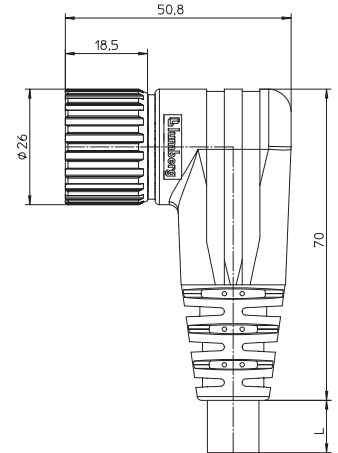

Pin Assignment

M23, 12-poles

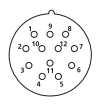

- 1 = white
- 2 = green
- 3 = yellow
- 4 = grey
- 5 = grey/pink
- 6 = red/blue
- 7 = white/green
- 8 = brown/green
- 9 = blue
- 10 = blue
- 11 = brown
- 12 = yellow/green

M23, 19-poles

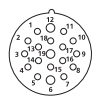

- 1 = violet
- 2 = red
- 3 = grey
- 4 = red/blue
- 5 = green
- 6 = blue
- 7 = grey/white
- 8 = white/green
- 9 = white/yellow
- 10 = white/grey
- 11 = black
- 12 = yellow/green
- 13 = yellow/brown
- 14 = brown/green
- 15 = white
- 16 = yellow
- 17 = pink
- 18 = grey/brown
- 19 = brown

Technical Data

Degree of protection IP 67 / NEMA 6P
Operating temperature range -25°C (-13°F) / +100°C (+212°F)

Mechanical

Housing TPU, self-extinguishing
Insert PBT
Contact Brass, pre-nickeled and 0.8 microns gold-plated

Coupling nut Brass, nickel-plated

Electrical

Voltage rating 12 poles: 240 V
19 poles: 120 V

Nominal current 12 poles: 8 A
19 poles: 8 A pin Ø 1 mm,
10 A pin Ø 1.5 mm

Mini

Micro (M12)







Micro (1/2"-20)

Pico (M8)

Cable Information

Cable Number	Outer Jacket	Conductor Size	Color	Outside Diameter
256	PUR, halogen-free	3 x 1.00 mm ² 8 x 0.50 mm ²	Black	.366" (9.3 mm)
242	PUR, halogen-free	3 x 1.00 mm ² 16 x 0.50 mm ²	Black	.457" (11.6 mm)

Din Valve Connectors

Part Number		Poles	
RKU 12-256/...M	RKWU 12-256/...M	12	  
RKU 19-242/...M	RKWU 19-242/...M	19	  

References

Standard cable lengths: 5 M / 10 M / 15 M / 20 M
Other cable lengths or cable specifications on request.