

Power SMD LED PLCC-2 Plus



22068

DESCRIPTION

The VLMR51..., VLMK51..., and VLMY51.. LED series in PLCC2 plus package are an advanced product in terms of high luminous flux and low thermal resistance.

In combination with the small package outline (3.5 mm x 3.5 mm x 1.2 mm) the PLCC2 plus is an ideal choice for backlighting, signage, exterior and interior automotive lighting as well as decorative lighting.

PRODUCT GROUP AND PACKAGE DATA

- Product group: LED
- Package: SMD PLCC-2 plus
- Product series: power
- Angle of half intensity: $\pm 60^\circ$

FEATURES

- High efficient AlInGaP technology
- Compact package outline 3.5 mm x 3.5 mm x 1.2 mm
- Angle of half intensity $\phi = \pm 60^\circ$
- Luminous intensity and color categorized per packing unit
- Luminous intensity ratio per packing unit $\phi_{\min.}/\phi_{\max.} < 1.6$
- ESD-withstand voltage: Up to 2 kV (HBM) according to JESD22-A114-B
- Preconditioning according to JEDEC® level 2a
- Compatible with IR-reflow soldering profiles according to J-STD-020
- AEC-Q101 qualified
- Material categorization: For definitions of compliance please see www.vishay.com/doc?99912

AUTOMOTIVE GRADE

RoHS
 COMPLIANT
 HALOGEN
FREE
GREEN
 (5-2008)

APPLICATIONS

- Interior and exterior automotive lighting: Dashboard, brake lights, turn lights, backlighting
- Signal and symbol luminaire
- Decorative lighting
- Architectural lighting
- Backlighting: LCDs, switches, keys, illuminated advertising
- Marker lights
- Traffic lights

PARTS TABLE

PART	COLOR	LUMINOUS INTENSITY (mcd)			at I _F (mA)	WAVELENGTH (nm)			at I _F (mA)	FORWARD VOLTAGE (V)			at I _F (mA)	TECHNOLOGY
		MIN.	TYP.	MAX.		MIN.	TYP.	MAX.		MIN.	TYP.	MAX.		
VLMR51Z1AA-GS08	Red	4500	7100	9000	140	620	-	630	140	1.9	2.2	2.65	140	AllnGaP on Si
VLMK51Z1AA-GS08	Amber	4500	7100	9000	140	610	-	621	140	1.9	2.2	2.65	140	AllnGaP on Si
VLMY51Z1AA-GS08	Yellow	4500	7100	9000	140	585	-	594	140	1.9	2.2	2.65	140	AllnGaP on Si

ABSOLUTE MAXIMUM RATINGS (T_{amb} = 25 °C, unless otherwise specified) VLMR51..., VLMK51..., VLMY51..

PARAMETER	TEST CONDITION	SYMBOL	VALUE	UNIT
Reverse voltage	I _R = 10 μA	V _R	12	V
DC forward current		I _F	200	mA
Surge forward current	t _p ≤ 10 μs	I _{FSM}	1000	mA
Power dissipation		P _V	530	mW
Junction temperature		T _j	125	°C
Operating temperature range		T _{amb}	- 40 to + 110	°C
Storage temperature range		T _{stg}	- 40 to + 110	°C
Thermal resistance junction/solder point		R _{thJS}	50	K/W
Thermal resistance junction/ambient	Mounted on PCB, total Cu area > 900 mm ²	R _{thJA}	100	K/W



OPTICAL AND ELECTRICAL CHARACTERISTICS ($T_{amb} = 25\text{ }^{\circ}\text{C}$, unless otherwise specified) VLMR51.., RED							
PARAMETER	TEST CONDITION	PART	SYMBOL	MIN.	TYP.	MAX.	UNIT
Luminous intensity	$I_F = 140\text{ mA}$	VLMR51Z1AA	I_V	4500	7100	9000	mcd
Luminous flux	$I_F = 140\text{ mA}$	VLMR51Z1AA	ϕ_V	-	20	-	lm
Dominant wavelength	$I_F = 140\text{ mA}$		λ_d	620	-	630	nm
Angle of half intensity	$I_F = 140\text{ mA}$		ϕ	-	± 60	-	deg
Forward voltage	$I_F = 140\text{ mA}$		V_F	1.9	2.2	2.65	V
Temperature coefficient I_V	$I_F = 140\text{ mA}, 0\text{ }^{\circ}\text{C} \leq T \leq 100\text{ }^{\circ}\text{C}$		TC_{I_V}	-	-26.8	-	mcd/K
Temperature coefficient V_F	$I_F = 140\text{ mA}, 0\text{ }^{\circ}\text{C} \leq T \leq 100\text{ }^{\circ}\text{C}$		TC_V	-	-3.5	-	mV/K
Temperature coefficient λ_d	$I_F = 140\text{ mA}, 0\text{ }^{\circ}\text{C} \leq T \leq 100\text{ }^{\circ}\text{C}$		TC_{λ_d}	-	0.06	-	nm/K

Note

- Forward voltages are tested using a current pulse of 1 ms and has an accuracy of $\pm 0.1\text{ V}$

OPTICAL AND ELECTRICAL CHARACTERISTICS ($T_{amb} = 25\text{ }^{\circ}\text{C}$, unless otherwise specified) VLMK51.., AMBER							
PARAMETER	TEST CONDITION	PART	SYMBOL	MIN.	TYP.	MAX.	UNIT
Luminous intensity	$I_F = 140\text{ mA}$	VLMK51Z1AA	I_V	4500	7100	9000	mcd
Luminous flux	$I_F = 140\text{ mA}$	VLMK51Z1AA	ϕ_V	-	20	-	lm
Dominant wavelength	$I_F = 140\text{ mA}$		λ_d	610	-	621	nm
Angle of half intensity	$I_F = 140\text{ mA}$		ϕ	-	± 60	-	deg
Forward voltage	$I_F = 140\text{ mA}$		V_F	1.9	2.2	2.65	V
Temperature coefficient I_V	$I_F = 140\text{ mA}, 0\text{ }^{\circ}\text{C} \leq T \leq 100\text{ }^{\circ}\text{C}$		TC_{I_V}	-	-35.3	-	mcd/K
Temperature coefficient V_F	$I_F = 140\text{ mA}, 0\text{ }^{\circ}\text{C} \leq T \leq 100\text{ }^{\circ}\text{C}$		TC_V	-	-2.9	-	mV/K
Temperature coefficient λ_d	$I_F = 140\text{ mA}, 0\text{ }^{\circ}\text{C} \leq T \leq 100\text{ }^{\circ}\text{C}$		TC_{λ_d}	-	0.07	-	nm/K

Note

- Forward voltages are tested using a current pulse of 1 ms and has an accuracy of $\pm 0.1\text{ V}$

OPTICAL AND ELECTRICAL CHARACTERISTICS ($T_{amb} = 25\text{ }^{\circ}\text{C}$, unless otherwise specified) VLMY51.., YELLOW							
PARAMETER	TEST CONDITION	PART	SYMBOL	MIN.	TYP.	MAX.	UNIT
Luminous intensity	$I_F = 140\text{ mA}$	VLMY51Z1AA	I_V	4500	7100	9000	mcd
Luminous flux	$I_F = 140\text{ mA}$	VLMY51Z1AA	ϕ_V	-	20	-	lm
Dominant wavelength	$I_F = 140\text{ mA}$		λ_d	585	-	594	nm
Angle of half intensity	$I_F = 140\text{ mA}$		ϕ	-	± 60	-	deg
Forward voltage	$I_F = 140\text{ mA}$		V_F	1.9	2.2	2.65	V
Temperature coefficient I_V	$I_F = 140\text{ mA}, 0\text{ }^{\circ}\text{C} \leq T \leq 100\text{ }^{\circ}\text{C}$		TC_{I_V}	-	-55.5	-	mcd/K
Temperature coefficient V_F	$I_F = 140\text{ mA}, 0\text{ }^{\circ}\text{C} \leq T \leq 100\text{ }^{\circ}\text{C}$		TC_V	-	-2.9	-	mV/K
Temperature coefficient λ_d	$I_F = 140\text{ mA}, 0\text{ }^{\circ}\text{C} \leq T \leq 100\text{ }^{\circ}\text{C}$		TC_{λ_d}	-	0.09	-	nm/K

Note

- Forward voltages are tested using a current pulse of 1 ms and has an accuracy of $\pm 0.1\text{ V}$



LUMINOUS INTENSITY CLASSIFICATION		
GROUP	LIGHT INTENSITY (mcd)	
STANDARD	MIN.	MAX.
Z1	4500	5600
Z2	5600	7150
AA	7150	9000

Note

- Luminous flux is tested at a current pulse duration of 25 ms and an accuracy of $\pm 11\%$. The above type numbers represent the order groups which include only a few brightness groups. Only one group will be shipped on each reel (there will be no mixing of two groups on each reel). In order to ensure availability, single brightness groups will not be orderable. In a similar manner for colors where wavelength groups are measured and binned, single wavelength groups will be shipped on any one reel. In order to ensure availability, single wavelength groups will not be orderable.

COLOR CLASSIFICATION				
GROUP	DOM. WAVELENGTH (nm)			
	AMBER		YELLOW	
	MIN.	MAX.	MIN.	MAX.
W	610	615	-	-
X	615	621	585	588
Y	-	-	588	591
Z	-	-	591	594

Note

- Wavelengths are tested at a current pulse duration of 25 ms and an accuracy of ± 1 nm.

TYPICAL CHARACTERISTICS ($T_{amb} = 25\text{ }^{\circ}\text{C}$, unless otherwise specified)

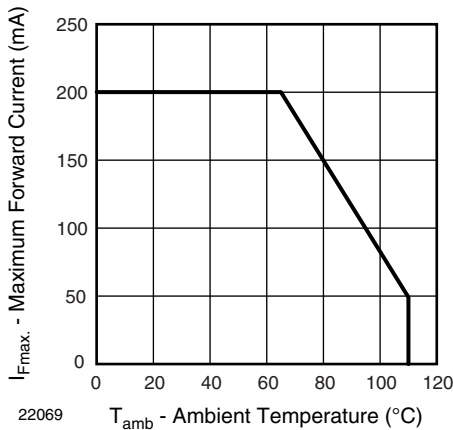

Fig. 1 - Forward Current vs. Ambient Temperature

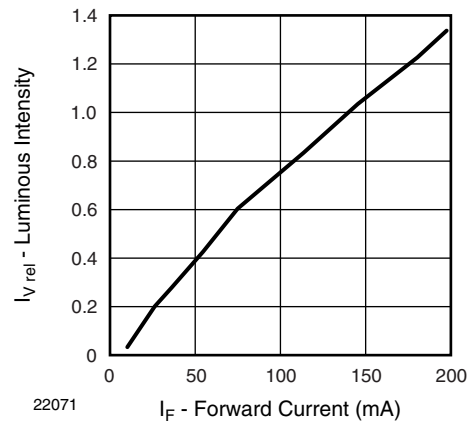

Fig. 3 - Relative Luminous Intensity vs. Forward Current

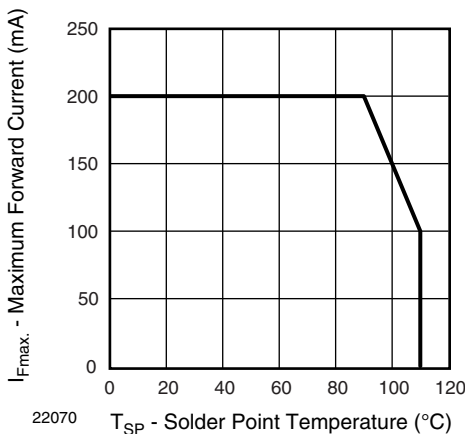

Fig. 2 - Maximum Forward Current vs. Solder Point Temperature

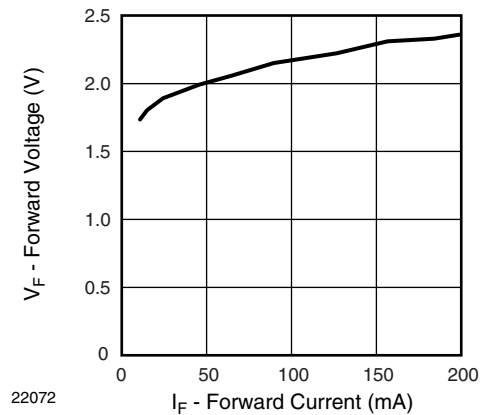

Fig. 4 - Relative Forward Voltage vs. Forward Current

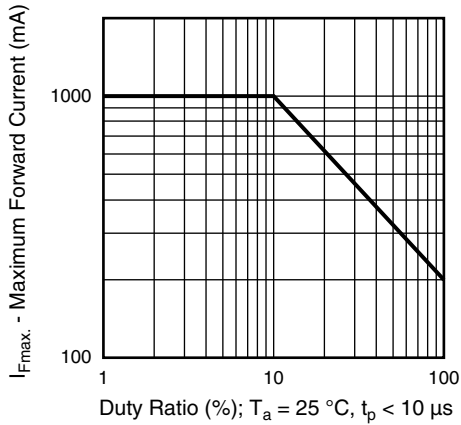

Fig. 5 - Forward Current vs. Duty Ratio

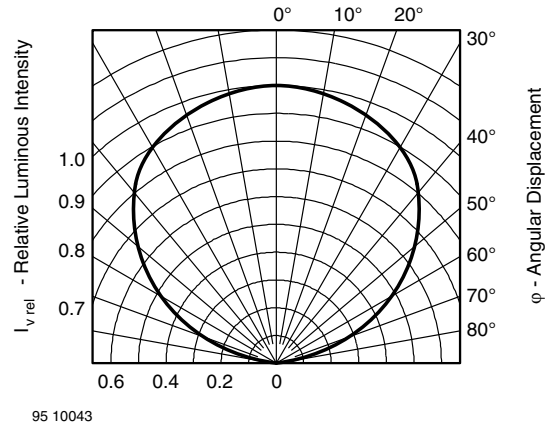

Fig. 7 - Relative Luminous Intensity vs. Angular Displacement

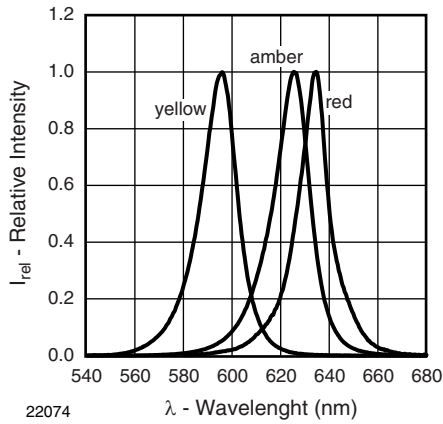
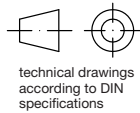
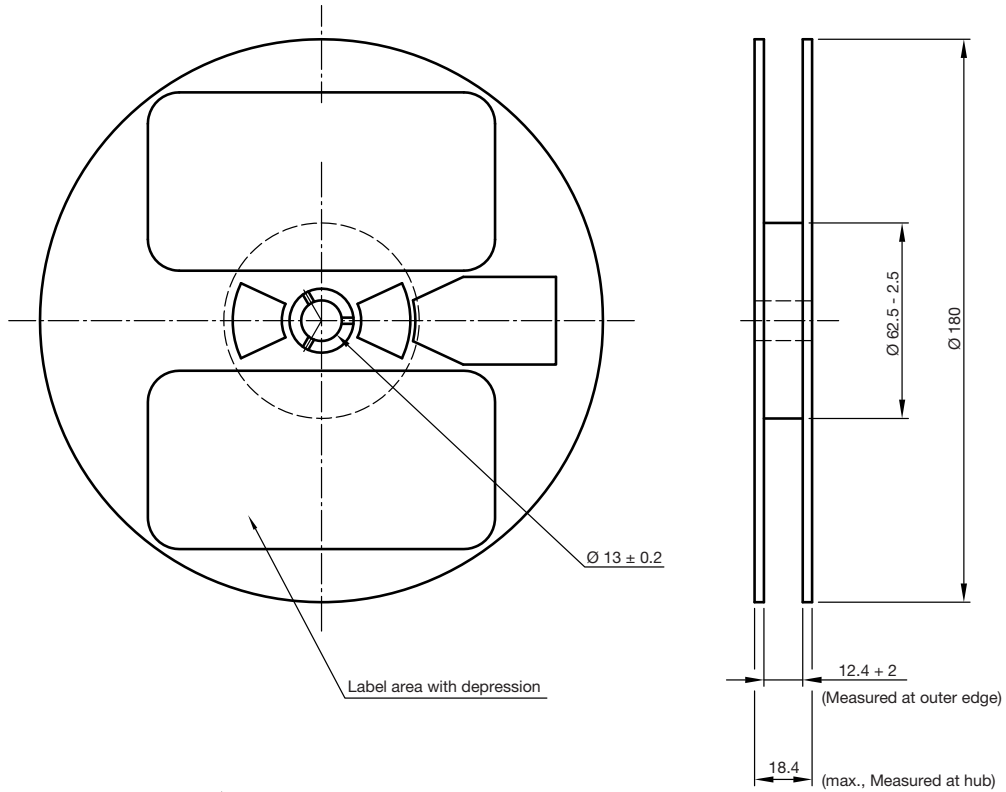

Fig. 6 - Relative Intensity vs. Wavelength



REEL DIMENSIONS in millimeters



Not indicated tolerances ± 0.5
 Material: black static dissipative

GS08 = 1000 pcs

Drawing-No.: 9.800-5104.01-4
 Issue: 2; 19.03.10
 22067



RECOMMENDED PAD DESIGN DIMENSIONS in millimeters

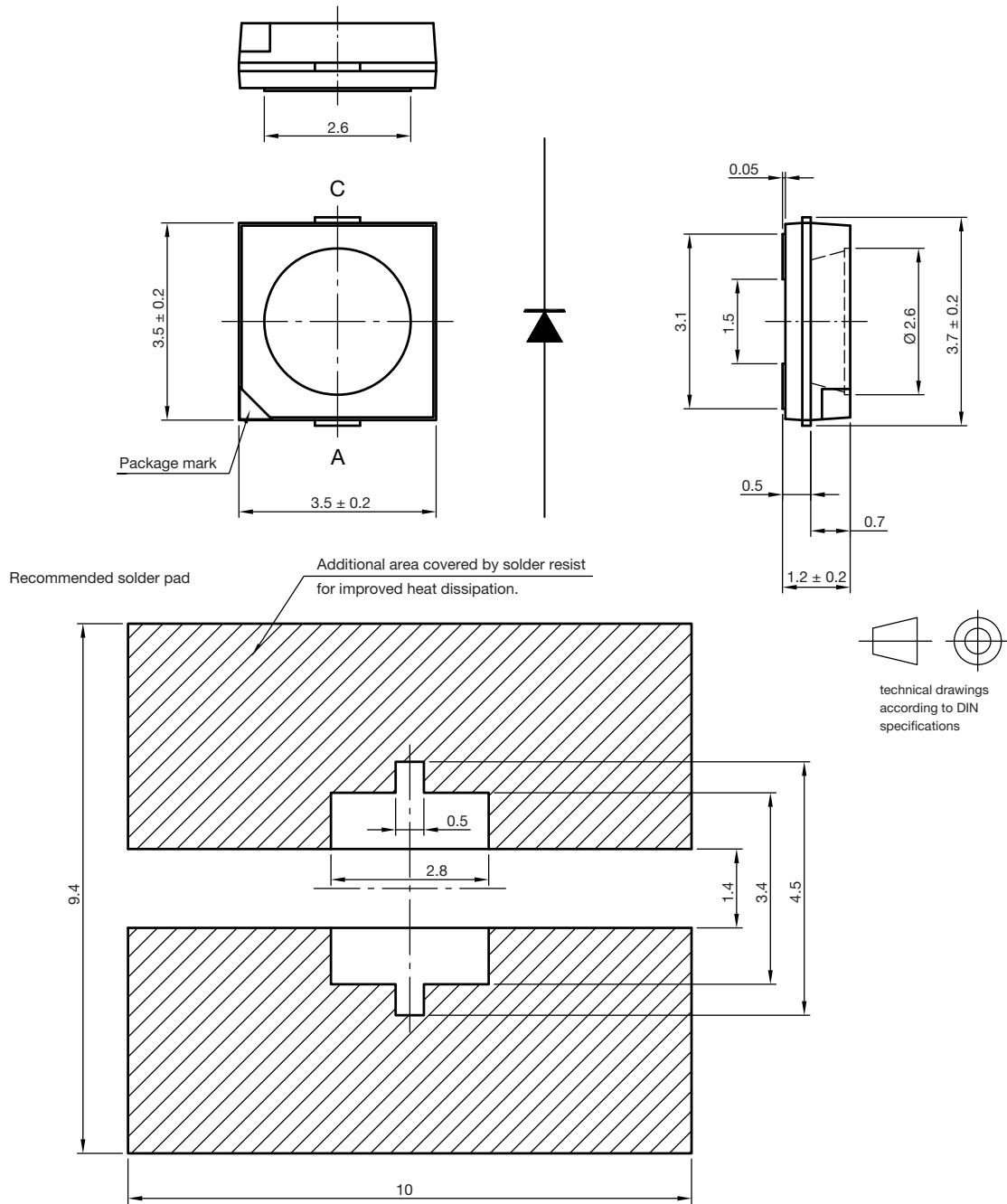

Drawing-No.: 6.541-5084.01-4

Issue: 1 ; 13.04.10

22103

SOLDERING PROFILE

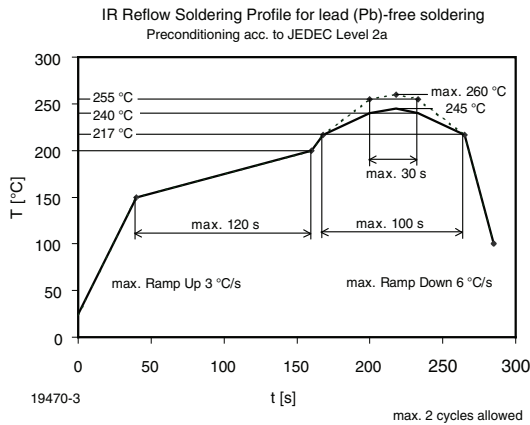
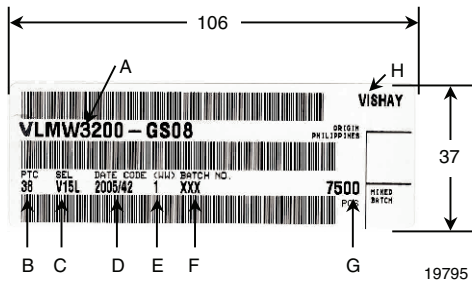

Fig. 8 - Vishay Lead (Pb)-free Reflow Soldering Profile (acc. to J-STD-020)

BAR CODE PRODUCT LABEL (example)



- A) Type of component
- B) Manufacturing plant
- C) SEL - selection code (bin):
e.g.: V1 = code for luminous intensity group
5L = code for chrom. coordinate group
- D) Date code year/week
- E) Day code (e.g. 1: Monday)
- F) Batch no.
- G) Total quantity
- H) Company code

DRY PACKING

The reel is packed in an anti-humidity bag to protect the devices from absorbing moisture during transportation and storage.

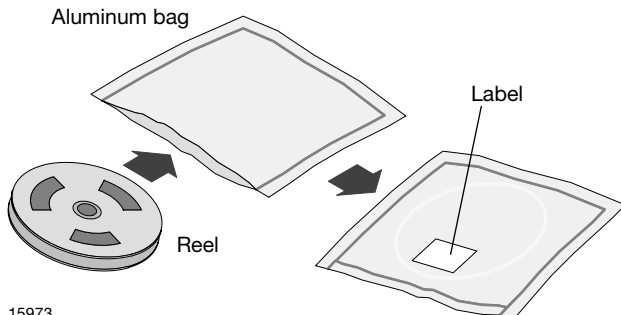

15973

FINAL PACKING

The sealed reel is packed into a cardboard box. A secondary cardboard box is used for shipping purposes.

RECOMMENDED METHOD OF STORAGE

Dry box storage is recommended as soon as the aluminum bag has been opened to prevent moisture absorption. The following conditions should be observed, if dry boxes are not available:

- Storage temperature 10 °C to 30 °C
- Storage humidity ≤ 60 % RH max.

After more than 672 h under these conditions moisture content will be too high for reflow soldering.

In case of moisture absorption, the devices will recover to the former condition by drying under the following condition:

- 192 h at 40 °C + 5 °C/- 0 °C and < 5 % RH (dry air/nitrogen) or
- 96 h at 60 °C + 5 °C and < 5 % RH for all device containers or
- 24 h at 100 °C + 5 °C not suitable for reel or tubes.

An EIA JEDEC standard JESD22-A112 level 2a label is included on all dry bags.

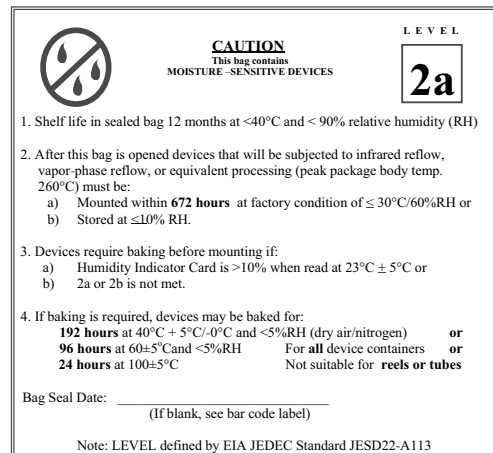

Example of JESD22-A112 Level 2a Label

ESD PRECAUTION

Proper storage and handling procedures should be followed to prevent ESD damage to the devices especially when they are removed from the antistatic shielding bag. Electro-static sensitive devices warning labels are on the packaging.



Disclaimer

ALL PRODUCT, PRODUCT SPECIFICATIONS AND DATA ARE SUBJECT TO CHANGE WITHOUT NOTICE TO IMPROVE RELIABILITY, FUNCTION OR DESIGN OR OTHERWISE.

Vishay Intertechnology, Inc., its affiliates, agents, and employees, and all persons acting on its or their behalf (collectively, "Vishay"), disclaim any and all liability for any errors, inaccuracies or incompleteness contained in any datasheet or in any other disclosure relating to any product.

Vishay makes no warranty, representation or guarantee regarding the suitability of the products for any particular purpose or the continuing production of any product. To the maximum extent permitted by applicable law, Vishay disclaims (i) any and all liability arising out of the application or use of any product, (ii) any and all liability, including without limitation special, consequential or incidental damages, and (iii) any and all implied warranties, including warranties of fitness for particular purpose, non-infringement and merchantability.

Statements regarding the suitability of products for certain types of applications are based on Vishay's knowledge of typical requirements that are often placed on Vishay products in generic applications. Such statements are not binding statements about the suitability of products for a particular application. It is the customer's responsibility to validate that a particular product with the properties described in the product specification is suitable for use in a particular application. Parameters provided in datasheets and / or specifications may vary in different applications and performance may vary over time. All operating parameters, including typical parameters, must be validated for each customer application by the customer's technical experts. Product specifications do not expand or otherwise modify Vishay's terms and conditions of purchase, including but not limited to the warranty expressed therein.

Except as expressly indicated in writing, Vishay products are not designed for use in medical, life-saving, or life-sustaining applications or for any other application in which the failure of the Vishay product could result in personal injury or death. Customers using or selling Vishay products not expressly indicated for use in such applications do so at their own risk. Please contact authorized Vishay personnel to obtain written terms and conditions regarding products designed for such applications.

No license, express or implied, by estoppel or otherwise, to any intellectual property rights is granted by this document or by any conduct of Vishay. Product names and markings noted herein may be trademarks of their respective owners.