Low Current Seven Segment Displays

Technical Data

HDSP-335x Series
HDSP-555x Series
HDSP-751x Series
HDSP-A10x Series
HDSP-A80x Series
HDSP-A90x Series
HDSP-E10x Series
HDSP-F10x Series
HDSP-G10x Series
HDSP-H10x Series
HDSP-K12x, K70x Series
HDSP-N10x Series

Features

- **Low Power Consumption**
- **Industry Standard Size**
- **Industry Standard Pinout**
- **Choice of Character Size**
7.6 mm (0.30 in), 10 mm (0.40 in), 10.9 mm (0.43 in), 14.2 mm (0.56 in), 20 mm (0.80 in)
- **Choice of Colors**
AlGaAs Red, High Efficiency Red (HER), Yellow, Green
- **Excellent Appearance**
Evenly Lighted Segments
 $\pm 50^\circ$ Viewing Angle
- **Design Flexibility**
Common Anode or Common Cathode
Single and Dual Digit
Left and Right Hand Decimal Points
 ± 1 . Overflow Character
- **Categorized for Luminous Intensity**
Yellow and Green Categorized for Color
Use of Like Categories Yields a Uniform Display
- **Excellent for Long Digit String Multiplexing**

Description

These low current seven segment displays are designed for applications requiring low power consumption. They are tested and selected for their excellent low current characteristics to ensure that the segments are matched at low currents. Drive currents as low as 1 mA per segment are available.

Pin for pin equivalent displays are also available in a standard current or high light ambient design. The standard current displays are available in all colors and are ideal for most applications. The high light ambient displays are ideal for sunlight ambients or long string lengths. For additional information see the 7.6 mm Micro Bright Seven Segment Displays, 10 mm Seven Segment Displays, 7.6 mm/10.9 mm Seven Segment Displays, 14.2 mm Seven Segment Displays, 20 mm Seven Segment Displays, or High Light Ambient Seven Segment Displays data sheets.

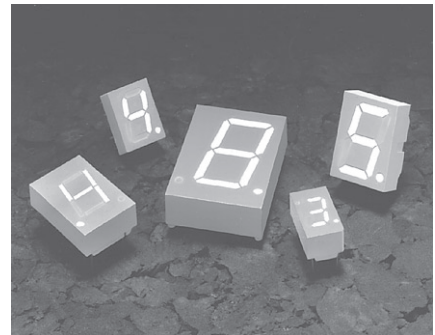

Devices

| AlGaAs HDSP- | HER HDSP- | Yellow HDSP- | Green HDSP- | Description | Package Drawing |
|--------------|-----------|--------------|-------------|---|-----------------|
| A101 | 7511 | A801 | A901 | 7.6 mm Common Anode Right Hand Decimal | A |
| A103 | 7513 | A803 | A903 | 7.6 mm Common Cathode Right Hand Decimal | B |
| A107 | 7517 | A807 | A907 | 7.6 mm Common Anode ± 1 . Overflow | C |
| A108 | 7518 | A808 | A908 | 7.6 mm Common Cathode ± 1 . Overflow | D |
| F101 | | | | 10 mm Common Anode Right Hand Decimal | E |
| F103 | | | | 10 mm Common Cathode Right Hand Decimal | F |
| F107 | | | | 10 mm Common Anode ± 1 . Overflow | G |
| F108 | | | | 10 mm Common Cathode ± 1 . Overflow | H |
| G101 | | | | 10 mm Two Digit Common Anode Right Hand Decimal | X |
| G103 | | | | 10 mm Two Digit Common Cathode Right Hand Decimal | Y |
| E100 | 3350 | | | 10.9 mm Common Anode Left Hand Decimal | I |
| E101 | 3351 | | | 10.9 mm Common Anode Right Hand Decimal | J |
| E103 | 3353 | | | 10.9 mm Common Cathode Right Hand Decimal | K |
| E106 | 3356 | | | 10.9 mm Universal ± 1 . Overflow ^[1] | L |
| H101 | 5551 | | | 14.2 mm Common Anode Right Hand Decimal | M |
| H103 | 5553 | | | 14.2 mm Common Cathode Right Hand Decimal | N |
| H107 | 5557 | | | 14.2 mm Common Anode ± 1 . Overflow | O |
| H108 | 5558 | | | 14.2 mm Common Cathode ± 1 . Overflow | P |
| K121 | K701 | | | 14.2 mm Two Digit Common Anode Right Hand Decimal | R |
| K123 | K703 | | | 14.2 mm Two Digit Common Cathode Right Hand Decimal | S |
| N100 | | | | 20 mm Common Anode Left Hand Decimal | Q |
| N101 | | | | 20 mm Common Anode Right Hand Decimal | T |
| N103 | | | | 20 mm Common Cathode Right Hand Decimal | U |
| N105 | | | | 20 mm Common Cathode Left Hand Decimal | V |
| N106 | | | | 20 mm Universal ± 1 . Overflow ^[1] | W |

Note:

1. Universal pinout brings the anode and cathode of each segment's LED out to separate pins. See internal diagrams L or W.

Part Numbering System

5082 - x xx x - x x x xx
 HDSP - x xx x - x x x xx

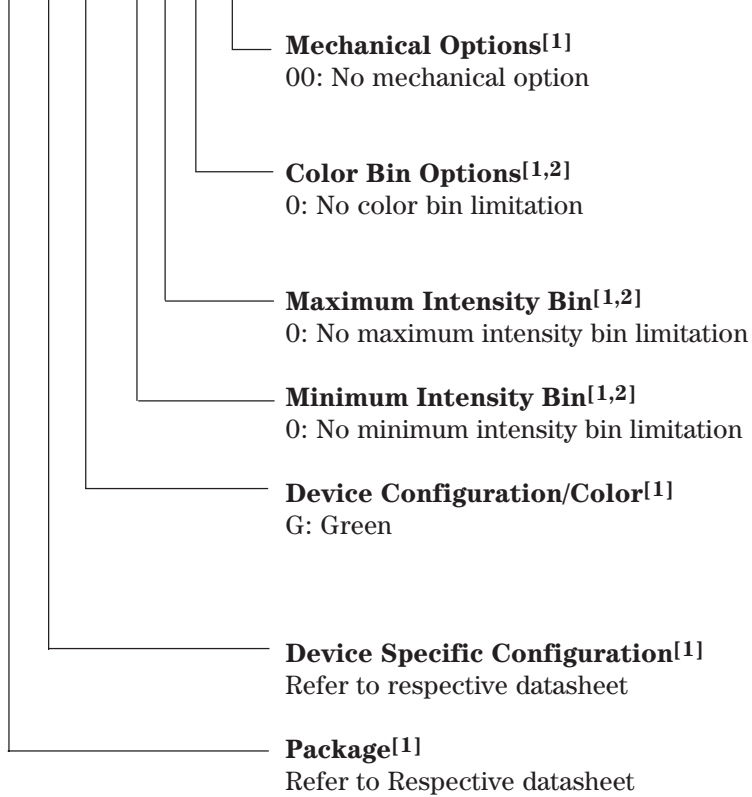

Notes:

1. For codes not listed in the figure above, please refer to the respective datasheet or contact your nearest Agilent representative for details.
2. Bin options refer to shippable bins for a part-number. Color and Intensity Bins are typically restricted to 1 bin per tube (exceptions may apply). Please refer to respective datasheet for specific bin limit information.

Package Dimensions

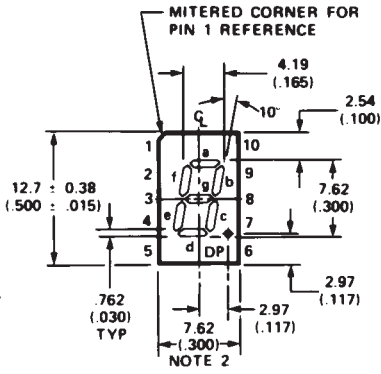

A, B

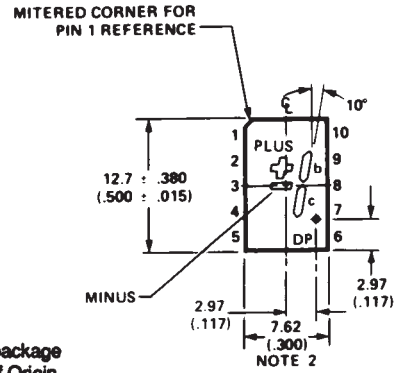
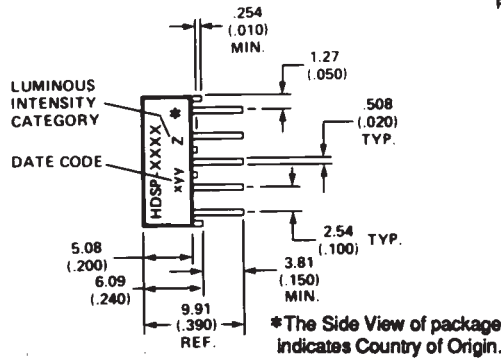

C, D

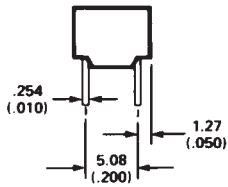

A, B, C, D

| PIN | FUNCTION | | | |
|-----|----------------------|------------------------|----------------------|------------------------|
| | A | B | C | D |
| 1 | ANODE ^[4] | CATHODE ^[5] | ANODE ^[4] | CATHODE ^[5] |
| 2 | CATHODE f | ANODE f | CATHODE PLUS | ANODE PLUS |
| 3 | CATHODE g | ANODE g | CATHODE MINUS | ANODE MINUS |
| 4 | CATHODE e | ANODE e | NC | NC |
| 5 | CATHODE d | ANODE d | NC | NC |
| 6 | ANODE ^[4] | CATHODE ^[5] | ANODE ^[4] | CATHODE ^[5] |
| 7 | CATHODE DP | ANODE DP | CATHODE DP | ANODE DP |
| 8 | CATHODE c | ANODE c | CATHODE c | ANODE c |
| 9 | CATHODE b | ANODE b | CATHODE b | ANODE b |
| 10 | CATHODE a | ANODE a | NC | NC |

NOTES:

1. ALL DIMENSIONS IN MILLIMETRES (INCHES).
2. MAXIMUM.
3. ALL UNTOLERANCED DIMENSIONS ARE FOR REFERENCE ONLY.
4. REDUNDANT ANODES.
5. REDUNDANT CATHODES.

Package Dimensions (cont.)

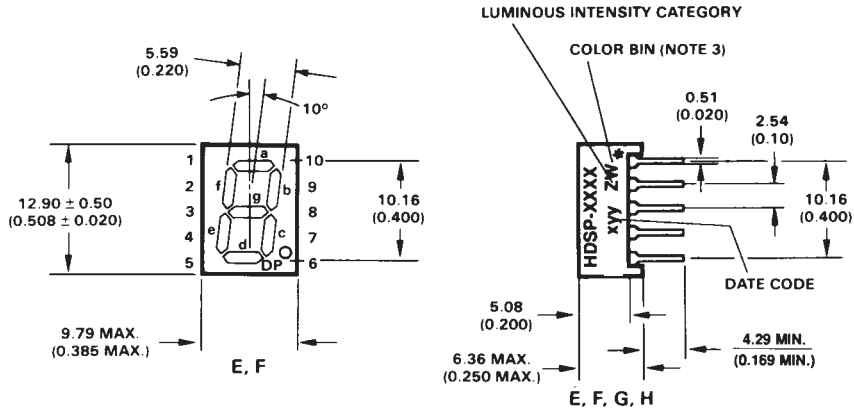

* The Side View of package indicates Country of Origin.

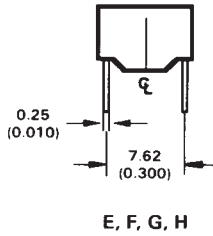

| PIN | FUNCTION | | | |
|-----|----------------------|------------------------|----------------------|------------------------|
| | E | F | G | H |
| 1 | ANODE ⁽¹⁾ | CATHODE ⁽²⁾ | ANODE ⁽¹⁾ | CATHODE ⁽²⁾ |
| 2 | CATHODE f | ANODE f | CATHODE PLUS | ANODE PLUS |
| 3 | CATHODE g | ANODE g | CATHODE MINUS | ANODE MINUS |
| 4 | CATHODE e | ANODE e | NC | NC |
| 5 | CATHODE d | ANODE d | NC | NC |
| 6 | ANODE ⁽¹⁾ | CATHODE ⁽²⁾ | ANODE ⁽¹⁾ | CATHODE ⁽²⁾ |
| 7 | CATHODE DP | ANODE DP | CATHODE DP | ANODE DP |
| 8 | CATHODE c | ANODE c | CATHODE c | ANODE c |
| 9 | CATHODE b | ANODE b | CATHODE b | ANODE b |
| 10 | CATHODE a | ANODE a | NC | NC |

NOTES:

1. ALL DIMENSIONS IN MILLIMETRES (INCHES).
2. ALL UNTOLERANCED DIMENSIONS ARE FOR REFERENCE ONLY.
3. FOR YELLOW AND GREEN SERIES PRODUCT ONLY.
4. REDUNDANT ANODES.
5. REDUNDANT CATHODES.

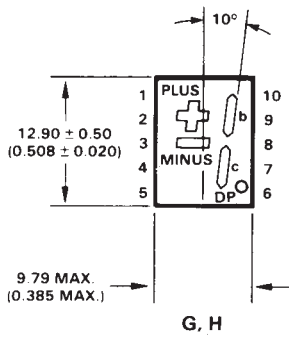

Package Dimensions (cont.)

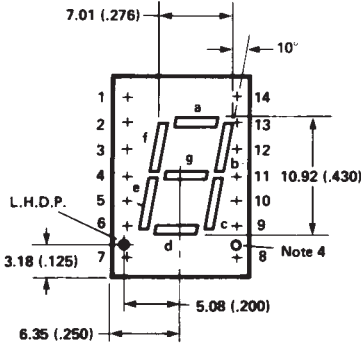

I
FRONT VIEW

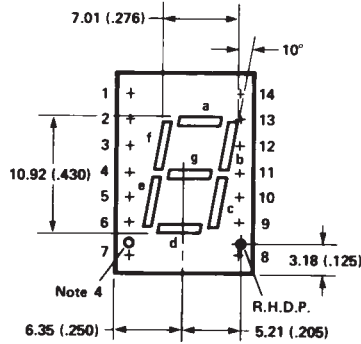

J, K
FRONT VIEW

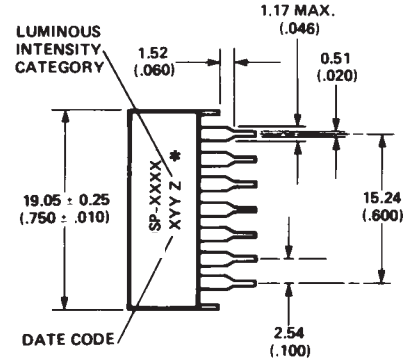

SIDE VIEW

*The Side View of package indicates Country of Origin.

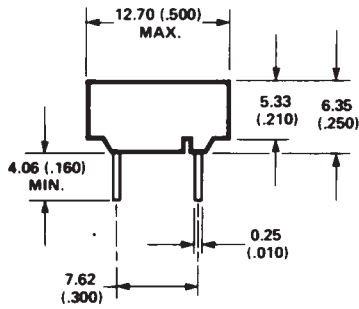

END VIEW

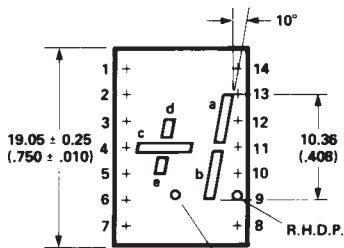

L

| PIN | FUNCTION | | | |
|-----|-------------------------|-------------------------|-------------------------|------------|
| | I | J | K | L |
| 1 | CATHODE-a | CATHODE-a | ANODE-a | CATHODE-d |
| 2 | CATHODE-f | CATHODE-f | ANODE-f | ANODE-d |
| 3 | ANODE ^[3] | ANODE ^[3] | CATHODE ^[6] | NO PIN |
| 4 | NO PIN | NO PIN | NO PIN | CATHODE-c |
| 5 | NO PIN | NO PIN | NO PIN | CATHODE-e |
| 6 | CATHODE-dp | NO CONN. ^[5] | NO CONN. ^[5] | ANODE-e |
| 7 | CATHODE-e | CATHODE-e | ANODE-e | ANODE-c |
| 8 | CATHODE-d | CATHODE-d | ANODE-d | ANODE-dp |
| 9 | NO CONN. ^[5] | CATHODE-dp | ANODE-dp | CATHODE-dp |
| 10 | CATHODE-c | CATHODE-c | ANODE-c | CATHODE-b |
| 11 | CATHODE-g | CATHODE-g | ANODE-g | CATHODE-a |
| 12 | NO PIN | NO PIN | NO PIN | NO PIN |
| 13 | CATHODE-b | CATHODE-b | ANODE-b | ANODE-a |
| 14 | ANODE ^[3] | ANODE ^[3] | CATHODE ^[6] | ANODE-b |

NOTES:

1. ALL DIMENSIONS IN MILLIMETRES (INCHES).
2. ALL UNTOLERANCED DIMENSIONS ARE FOR REFERENCE ONLY.
3. REDUNDANT ANODES.
4. UNUSED dp POSITION.
5. SEE INTERNAL CIRCUIT DIAGRAM.
6. REDUNDANT CATHODES.
7. SEE PART NUMBER TABLE FOR L.H.D.P. AND R.H.D.P. DESIGNATION.

Package Dimensions (cont.)

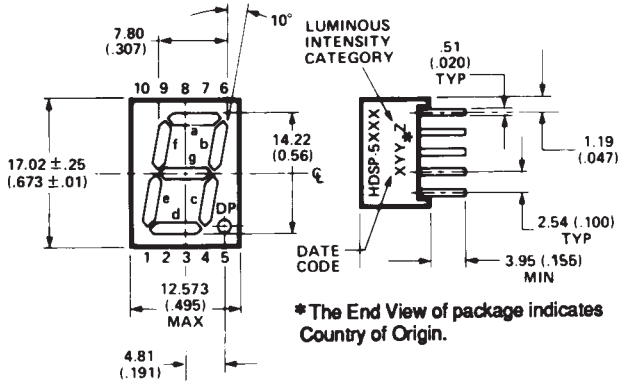

M, N
FRONT VIEW

M, N, O, P
TOP END VIEW

* The End View of package indicates Country of Origin.

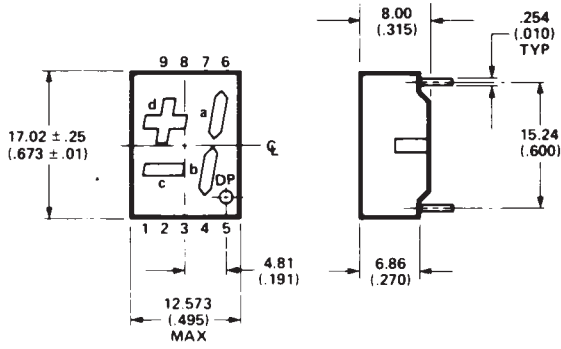

FRONT VIEW O, P

SIDE VIEW M, N, O, P

| PIN | FUNCTION | | | |
|-----|------------|------------|----------------|------------------|
| | M | N | O | P |
| 1 | CATHODE e | ANODE e | CATHODE c | ANODE c |
| 2 | CATHODE d | ANODE d | ANODE c, d | CATHODE c, d |
| 3 | ANODE[4] | CATHODE[5] | CATHODE b | ANODE b |
| 4 | CATHODE c | ANODE c | ANODE a, b, DP | CATHODE a, b, DP |
| 5 | CATHODE DP | ANODE DP | CATHODE DP | ANODE DP |
| 6 | CATHODE b | ANODE b | CATHODE a | ANODE a |
| 7 | CATHODE a | ANODE a | ANODE a, b, DP | CATHODE a, b, DP |
| 8 | ANODE[4] | CATHODE[5] | ANODE c, d | CATHODE c, d |
| 9 | CATHODE f | ANODE f | CATHODE d | ANODE d |
| 10 | CATHODE g | ANODE g | NO PIN | NO PIN |

NOTES:

1. ALL DIMENSIONS IN MILLIMETRES (INCHES).
2. MAXIMUM.
3. ALL UNTOLERANCED DIMENSIONS ARE FOR REFERENCE ONLY.
4. REDUNDANT ANODES.
5. REDUNDANT CATHODES.

Package Dimensions (cont.)



*The Side View of package indicates Country of Origin.

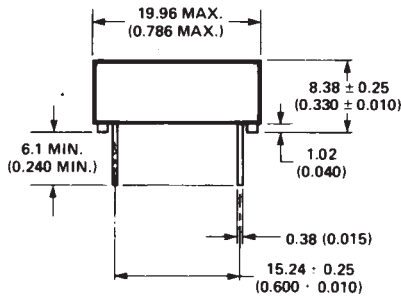

| Pin | Function | | | | |
|-----|----------------------|----------------------|------------------------|------------------------|------------|
| | Q | T | U | V | W |
| 1 | NO PIN | NO PIN | NO PIN | NO PIN | NO PIN |
| 2 | CATHODE a | CATHODE a | ANODE a | ANODE a | CATHODE a |
| 3 | CATHODE f | CATHODE f | ANODE f | ANODE f | ANODE d |
| 4 | ANODE ⁽³⁾ | ANODE ⁽³⁾ | CATHODE ⁽⁶⁾ | CATHODE ⁽⁶⁾ | CATHODE d |
| 5 | CATHODE e | CATHODE e | ANODE e | ANODE e | CATHODE c |
| 6 | ANODE ⁽³⁾ | ANODE ⁽³⁾ | CATHODE ⁽⁶⁾ | CATHODE ⁽⁶⁾ | CATHODE e |
| 7 | CATHODE dp | NO CONNEC | NO CONNEC | ANODE dp | ANODE e |
| 8 | NO PIN | NO PIN | NO PIN | NO PIN | CATHODE dp |
| 9 | NO PIN | NO PIN | NO PIN | NO PIN | NO PIN |
| 10 | NO PIN | CATHODE dp | ANODE dp | NO PIN | ANODE dp |
| 11 | CATHODE d | CATHODE d | ANODE d | ANODE d | CATHODE dp |
| 12 | ANODE ⁽³⁾ | ANODE ⁽³⁾ | CATHODE ⁽⁶⁾ | CATHODE ⁽⁶⁾ | CATHODE b |
| 13 | CATHODE c | CATHODE c | ANODE c | ANODE c | ANODE b |
| 14 | CATHODE g | CATHODE g | ANODE g | ANODE g | ANODE c |
| 15 | CATHODE b | CATHODE b | ANODE b | ANODE b | ANODE a |
| 16 | NO PIN | NO PIN | NO PIN | NO PIN | NO PIN |
| 17 | ANODE ⁽³⁾ | ANODE ⁽³⁾ | CATHODE ⁽⁶⁾ | CATHODE ⁽⁶⁾ | CATHODE a |
| 18 | NO PIN | NO PIN | NO PIN | NO PIN | NO PIN |

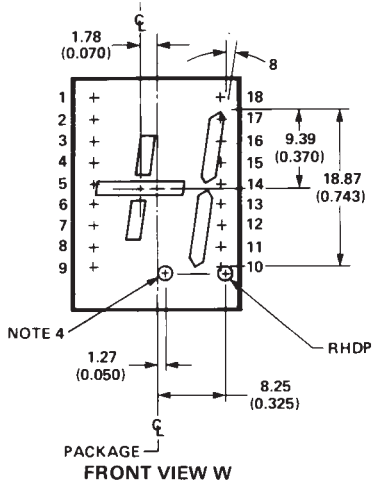

NOTES:

1. ALL DIMENSIONS IN MILLIMETRES (INCHES).
2. ALL UNTOLERANCED DIMENSIONS ARE FOR REFERENCE ONLY.
3. REDUNDANT ANODES.
4. UNUSED dp POSITION.
5. SEE INTERNAL CIRCUIT DIAGRAM.
6. REDUNDANT CATHODES.
7. SEE PART NUMBER TABLE FOR L.H.D.P. AND R.H.D.P. DESIGNATION.

Package Dimensions (cont.)



TOP END VIEW R, S

*The Side View of package indicates Country of Origin.



FRONT VIEW R, S

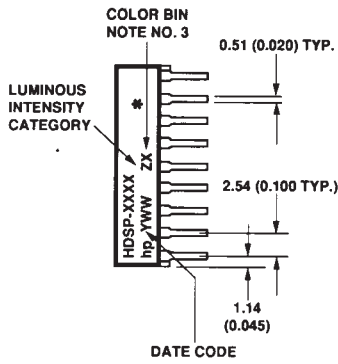

TOP END VIEW X, Y

*The Side View of package indicates Country of Origin.



FRONT VIEW X, Y

| Pin | Function | |
|-----|-------------------|---------------------|
| | R,X | S,Y |
| 1 | E CATHODE NO. 1 | E ANODE NO. 1 |
| 2 | D CATHODE NO. 1 | D ANODE NO. 1 |
| 3 | C CATHODE NO. 1 | C ANODE NO. 1 |
| 4 | DP CATHODE NO. 1 | DP ANODE NO. 1 |
| 5 | E CATHODE NO. 2 | E ANODE NO. 2 |
| 6 | D CATHODE NO. 2 | D ANODE NO. 2 |
| 7 | G CATHODE NO. 2 | G ANODE NO. 2 |
| 8 | C CATHODE NO. 2 | C ANODE NO. 2 |
| 9 | DP CATHODE NO. 2 | DP ANODE NO. 2 |
| 10 | B CATHODE NO. 2 | B ANODE NO. 2 |
| 11 | A CATHODE NO. 2 | A ANODE NO. 2 |
| 12 | F CATHODE NO. 2 | F ANODE NO. 2 |
| 13 | DIGIT NO. 2 ANODE | DIGIT NO. 2 CATHODE |
| 14 | DIGIT NO. 1 ANODE | DIGIT NO. 1 CATHODE |
| 15 | B CATHODE NO. 1 | B ANODE NO. 1 |
| 16 | A CATHODE NO. 1 | A ANODE NO. 1 |
| 17 | G CATHODE NO. 1 | G ANODE NO. 1 |
| 18 | F CATHODE NO. 1 | F ANODE NO. 1 |

NOTES:
 1. DIMENSIONS ARE IN MILLIMETRES (INCHES).
 2. ALL UNTOLERANCED DIMENSIONS ARE FOR REFERENCE ONLY.
 3. WHERE APPLICABLE.

Internal Circuit Diagram

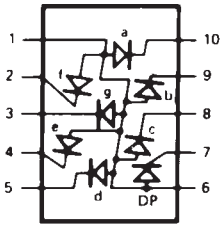

A, E

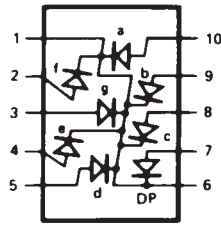

B, F

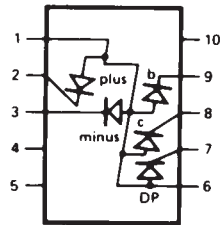

C, G

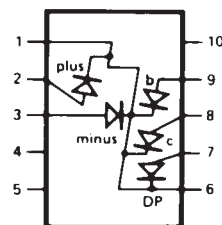

D, H

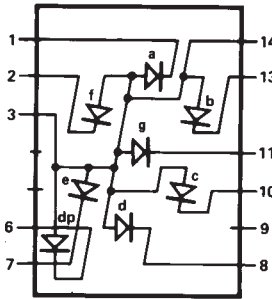

I

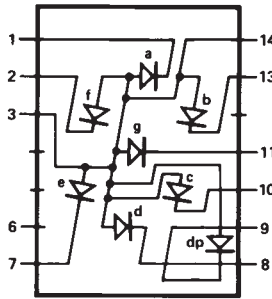

J

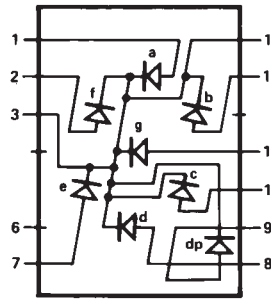

K

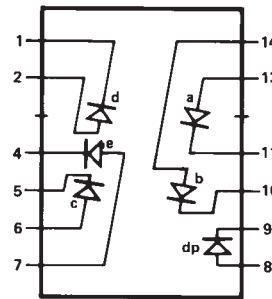

L

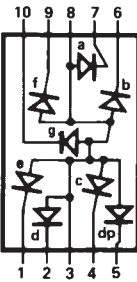

M

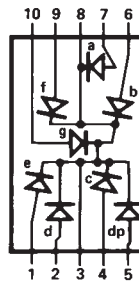

N

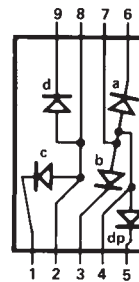

O

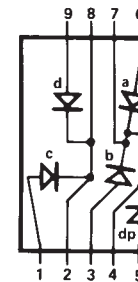

P

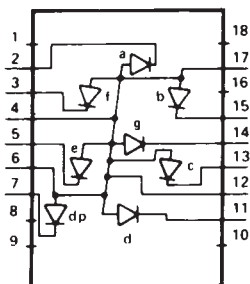

Q

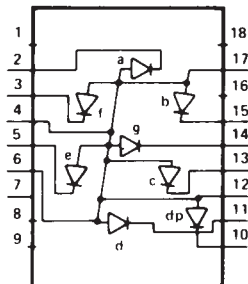

T

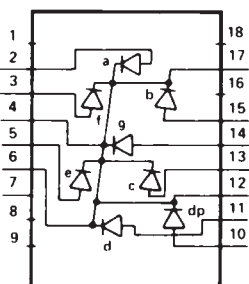

U

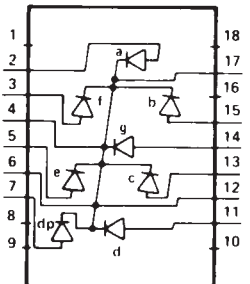

V

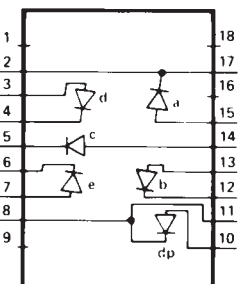

W

Internal Circuit Diagram (cont.)



HOLE PATTERN FOR PCB LAYOUT TO ACHIEVE UNIFORM 0.450 in. DIGIT TO DIGIT PITCH. FOR HDSP-FXXX TO HDSP-GXXX.

Absolute Maximum Ratings

| Description | AlGaAs Red HDSP-A10X/E10X/ H10X/K12X/N10X/ F10X, G10X Series | HER HDSP-751X/ 335X/555X/ K70X Series | Yellow HDSP-A80X Series | Green HDSP-A90X Series | Units |
|---|---|--|-------------------------------|------------------------------|-------|
| Average Power per Segment or DP | 37 | 52 | | 64 | mW |
| Peak Forward Current per Segment or DP | 45 | | | | mA |
| DC Forward Current per Segment or DP | 15 ^[1] | 15 ^[2] | | | mA |
| Operating Temperature Range | -20 to +100 | -40 to +100 | | | °C |
| Storage Temperature Range | -55 to +100 | | | | °C |
| Reverse Voltage per Segment or DP | 3.0 | | | | V |
| Lead Solder Temperature for 3 Seconds (1.60 mm [0.063 in.] below seating plane) | 260 | | | | °C |

Notes:

1. Derate above 91°C at 0.53 mA/°C.
2. Derate HER/Yellow above 80°C at 0.38 mA/°C and Green above 71°C at 0.31 mA/°C.

Electrical/Optical Characteristics at $T_A = 25^\circ\text{C}$

AlGaAs Red

| Device Series HDSP- | Parameter | Symbol | Min. | Typ. | Max. | Units | Test Conditions | | | |
|------------------------|--|-----------------------------|------------------------------------|-------------------------|------|----------------|-------------------------|----------------------|----|--------------------------|
| A10x | Luminous Intensity/Segment ^[1,2] (Digit Average) | I_V | 315 | 600 | | μcd | $I_F = 1 \text{ mA}$ | | | |
| F10x, G10x | | | | 3600 | | | | $I_F = 5 \text{ mA}$ | | |
| | | | | 330 | 650 | | | $I_F = 1 \text{ mA}$ | | |
| E10x | | | | 390 | 650 | | | $I_F = 1 \text{ mA}$ | | |
| | | | | | 3900 | | | $I_F = 5 \text{ mA}$ | | |
| H10x, K12x | | | | 400 | 700 | | | $I_F = 1 \text{ mA}$ | | |
| | | | | | 4200 | | | $I_F = 5 \text{ mA}$ | | |
| N10x | | | | 270 | 590 | | | $I_F = 1 \text{ mA}$ | | |
| | | | | | 3500 | | | $I_F = 5 \text{ mA}$ | | |
| All Devices | | | Forward Voltage/Segment or DP | V_F | | | 1.6 | | V | $I_F = 1 \text{ mA}$ |
| | | | | | | | 1.7 | | | $I_F = 5 \text{ mA}$ |
| | | | | | | | 1.8 | 2.2 | | $I_F = 20 \text{ mA Pk}$ |
| | | | Peak Wavelength | λ_{PEAK} | | | 645 | | nm | |
| | | | Dominant Wavelength ^[3] | λ_d | | | 637 | | nm | |
| | Reverse Voltage/Segment or DP ^[4] | V_R | 3.0 | 15 | | V | $I_R = 100 \mu\text{A}$ | | | |
| | Temperature Coefficient of V_F /Segment or DP | $\Delta V_F/^\circ\text{C}$ | | -2 mV | | mV/°C | | | | |
| A10x | Thermal Resistance LED Junction-to-Pin | $R_{\theta\text{J-PIN}}$ | | 255 | | °C/W/Seg | | | | |
| F10x, G10x | | | | 320 | | | | | | |
| E10x | | | | 340 | | | | | | |
| H10x, K12x | | | | 400 | | | | | | |
| N10x | | | | 430 | | | | | | |

High Efficiency Red

| Device Series HDSP- | Parameter | Symbol | Min. | Typ. | Max. | Units | Test Conditions |
|------------------------|--|---------------------|------|------|------|-------|---------------------------|
| 751x | Luminous Intensity/Segment ^[1,2] (Digit Average) | I _V | 160 | 270 | | mcd | I _F = 2 mA |
| | | | | 1050 | | | I _F = 5 mA |
| 335x, 555x, K70x | | | 200 | 300 | | | I _F = 2 mA |
| | | | | 1200 | | | I _F = 5 mA |
| | | | 270 | 370 | | | I _F = 2 mA |
| | | | | 1480 | | | I _F = 5 mA |
| All Devices | Forward Voltage/Segment or DP | V _F | | 1.6 | | V | I _F = 2 mA |
| | | | | 1.7 | | | I _F = 5 mA |
| | | | | 2.1 | 2.5 | | I _F = 20 mA Pk |
| | Peak Wavelength | λ _{PEAK} | | 635 | | nm | |
| | Dominant Wavelength ^[3] | λ _d | | 626 | | nm | |
| | Reverse Voltage/Segment or DP ^[4] | V _R | 3.0 | 30 | | V | I _R = 100 μA |
| | Temperature Coefficient of V _F /Segment or DP | ΔV _F /°C | | -2 | | mV/°C | |
| 751x | Thermal Resistance LED Junction-to-Pin | R _{θJ-PIN} | | 200 | | °C/W | |
| 335x | | | | 280 | | | |
| 555x, K70x | | | | 345 | | | |

Yellow

| Device Series HDSP- | Parameter | Symbol | Min. | Typ. | Max. | Units | Test Conditions |
|---|--|-------------------|-------|------|-------|-------|---------------------------|
| A80x | Luminous Intensity/Segment ^[1,2] (Digit Average) | I _V | 250 | 420 | | mcd | I _F = 4 mA |
| | | | | 1300 | | | I _F = 10 mA |
| | Forward Voltage/Segment or DP | V _F | | 1.7 | | V | I _F = 4 mA |
| | | | | 1.8 | | | I _F = 5 mA |
| | | | | 2.1 | 2.5 | | I _F = 20 mA Pk |
| | Peak Wavelength | λ _{PEAK} | | 583 | | nm | |
| | Dominant Wavelength ^[3,5] | λ _d | 581.5 | 585 | 592.5 | nm | |
| | Reverse Voltage/Segment or DP ^[4] | V _R | 3.0 | 30 | | V | I _R = 100 μA |
| Temperature Coefficient of V _F /Segment or DP | ΔV _F /°C | | -2 | | mV/°C | | |
| Thermal Resistance LED Junction-to-Pin | Rθ _{J-PIN} | | 200 | | °C/W | | |

Green

| Device Series HDSP- | Parameter | Symbol | Min. | Typ. | Max. | Units | Test Conditions |
|---|--|-------------------|------|------|-------|-------|---------------------------|
| A90x | Luminous Intensity/Segment ^[1,2] (Digit Average) | I _V | 250 | 475 | | mcd | I _F = 4 mA |
| | | | | 1500 | | | I _F = 10 mA |
| | Forward Voltage/Segment or DP | V _F | | 1.9 | | V | I _F = 4 mA |
| | | | | 2.0 | | | I _F = 10 mA |
| | | | | 2.1 | 2.5 | | I _F = 20 mA Pk |
| | Peak Wavelength | λ _{PEAK} | | 566 | | nm | |
| | Dominant Wavelength ^[3,5] | λ _d | | 571 | 577 | nm | |
| | Reverse Voltage/Segment or DP ^[4] | V _R | 3.0 | 30 | | V | I _R = 100 μA |
| Temperature Coefficient of V _F /Segment or DP | ΔV _F /°C | | -2 | | mV/°C | | |
| Thermal Resistance LED Junction-to-Pin | Rθ _{J-PIN} | | 200 | | °C/W | | |

Notes:

1. Device case temperature is 25°C prior to the intensity measurement.
2. The digits are categorized for luminous intensity. The intensity category is designated by a letter on the side of the package.
3. The dominant wavelength, λ_d, is derived from the CIE chromaticity diagram and is the single wavelength which defines the color of the device.
4. Typical specification for reference only. Do not exceed absolute maximum ratings.
5. The yellow (HDSP-A800) and Green (HDSP-A900) displays are categorized for dominant wavelength. The category is designated by a number adjacent to the luminous intensity category letter.

AlGaAs Red

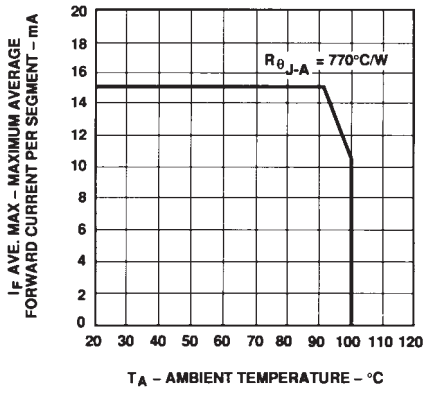

Figure 1. Maximum Allowable Average or DC Current vs. Ambient Temperature.



Figure 2. Forward Current vs. Forward Voltage.

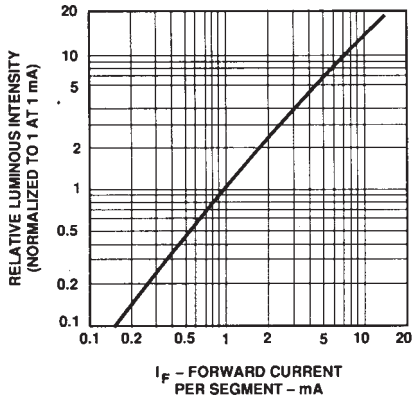

Figure 3. Relative Luminous Intensity vs. DC Forward Current.

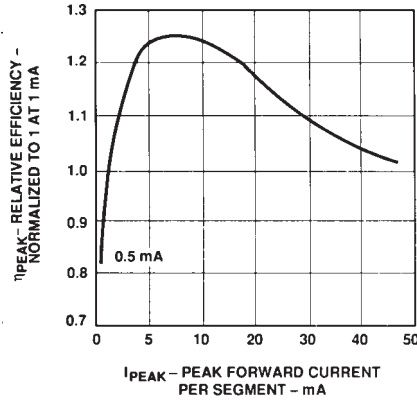

Figure 4. Relative Efficiency (Luminous Intensity per Unit Current) vs. Peak Current.

HER, Yellow, Green

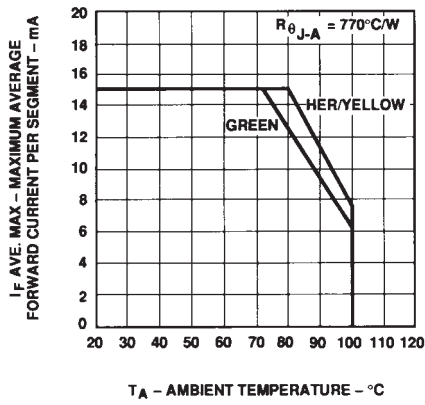

Figure 5. Maximum Allowable Average or DC Current vs. Ambient Temperature.



Figure 6. Forward Current vs. Forward Voltage.

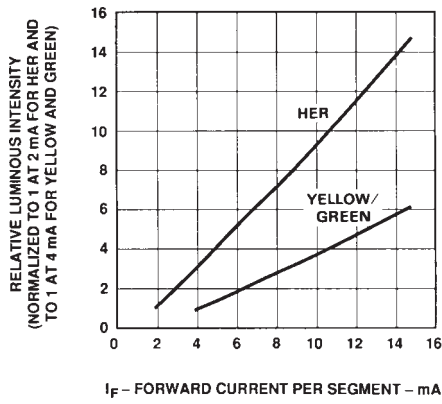

Figure 7. Relative Luminous Intensity vs. DC Forward Current.



Figure 8. Relative Efficiency (Luminous Intensity per Unit Current) vs. Peak Current.

Intensity Bin Limits (mcd)
AlGaAs Red

| HDSP-A10x | | |
|------------------------|-------------|-------------|
| IV Bin Category | Min. | Max. |
| E | 0.315 | 0.520 |
| F | 0.428 | 0.759 |
| G | 0.621 | 1.16 |
| H | 0.945 | 1.71 |
| I | 1.40 | 2.56 |
| J | 2.10 | 3.84 |
| K | 3.14 | 5.75 |
| L | 4.70 | 8.55 |

| HDSP-E10x/F10x/G10x | | |
|----------------------------|-------------|-------------|
| IV Bin Category | Min. | Max. |
| D | 0.391 | 0.650 |
| E | 0.532 | 0.923 |
| F | 0.755 | 1.39 |
| G | 1.13 | 2.08 |
| H | 1.70 | 3.14 |

| HDSP-H10x/K12x | | |
|------------------------|-------------|-------------|
| IV Bin Category | Min. | Max. |
| C | 0.415 | 0.690 |
| D | 0.565 | 0.990 |
| E | 0.810 | 1.50 |
| F | 1.20 | 2.20 |
| G | 1.80 | 3.30 |
| H | 2.73 | 5.00 |
| I | 4.09 | 7.50 |

| HDSP-N10x | | |
|------------------------|-------------|-------------|
| IV Bin Category | Min. | Max. |
| A | 0.270 | 0.400 |
| B | 0.325 | 0.500 |
| C | 0.415 | 0.690 |
| D | 0.565 | 0.990 |
| E | 0.810 | 1.50 |
| F | 1.20 | 2.20 |
| G | 1.80 | 3.30 |
| H | 2.73 | 5.00 |
| I | 4.09 | 7.50 |

Intensity Bin Limits (mcd), continued
HER

| HDSP-751x | | |
|------------------------|-------------|-------------|
| IV Bin Category | Min. | Max. |
| B | 0.160 | 0.240 |
| C | 0.200 | 0.300 |
| D | 0.250 | 0.385 |
| E | 0.315 | 0.520 |
| F | 0.428 | 0.759 |
| G | 0.621 | 1.16 |

| HDSP-751x | | |
|------------------------|-------------|-------------|
| IV Bin Category | Min. | Max. |
| B | 0.240 | 0.366 |
| C | 0.300 | 0.477 |
| D | 0.391 | 0.650 |
| E | 0.532 | 0.923 |
| F | 0.755 | 1.39 |
| G | 1.13 | 2.08 |
| H | 1.70 | 3.14 |

| HDSP-555x/K70x | | |
|------------------------|-------------|-------------|
| IV Bin Category | Min. | Max. |
| A | 0.270 | 0.400 |
| B | 0.325 | 0.500 |
| C | 0.415 | 0.690 |
| D | 0.565 | 0.990 |
| E | 0.810 | 1.50 |
| F | 1.20 | 2.20 |
| G | 1.80 | 3.30 |
| H | 2.73 | 5.00 |
| I | 4.09 | 7.50 |

Intensity Bin Limits (mcd), continued
Yellow

| HDSP-A80x | | |
|------------------------|-------------|-------------|
| IV Bin Category | Min. | Max. |
| D | 0.250 | 0.385 |
| E | 0.315 | 0.520 |
| F | 0.425 | 0.760 |
| G | 0.625 | 1.14 |
| H | 0.940 | 1.70 |
| I | 1.40 | 2.56 |
| J | 2.10 | 3.84 |
| K | 3.14 | 5.76 |
| L | 4.71 | 8.64 |
| M | 7.07 | 13.00 |
| N | 10.60 | 19.40 |
| O | 15.90 | 29.20 |
| P | 23.90 | 43.80 |
| Q | 35.80 | 65.60 |

Green

| HDSP-A90x | | |
|------------------------|-------------|-------------|
| IV Bin Category | Min. | Max. |
| E | 0.315 | 0.520 |
| F | 0.425 | 0.760 |
| G | 0.625 | 1.14 |
| H | 0.940 | 1.70 |
| I | 1.40 | 2.56 |
| J | 2.10 | 3.84 |
| K | 3.14 | 5.76 |
| L | 4.71 | 8.64 |
| M | 7.07 | 13.00 |
| N | 10.60 | 19.40 |
| O | 15.90 | 29.20 |
| P | 23.90 | 43.80 |
| Q | 35.80 | 65.60 |

Color Categories

| Color | Bin | Dominant Wavelength (nm) | |
|--------|-----|--------------------------|--------|
| | | Min. | Max. |
| Yellow | 1 | 581.50 | 585.00 |
| | 3 | 584.00 | 587.50 |
| | 2 | 586.50 | 590.00 |
| | 4 | 589.00 | 592.50 |
| Green | 2 | 573.00 | 577.00 |
| | 3 | 570.00 | 574.00 |
| | 4 | 567.00 | 571.00 |
| | 5 | 564.00 | 568.00 |

Note:

All categories are established for classification of products. Products may not be available in all categories. Please contact your local Agilent representatives for further clarification/information.

Electrical/Optical

For more information on electrical/optical characteristics, please see Application Note 1005.

Contrast Enhancement

For information on contrast enhancement, please see Application Note 1015.

Soldering/Cleaning

Cleaning agents from the ketone family (acetone, methyl ethyl ketone, etc.) and from the

chlorinated hydrocarbon family (methylene chloride, trichloroethylene, carbon tetrachloride, etc.) are not recommended for cleaning LED parts. All of these various solvents attack or dissolve the encapsulating epoxies used to form the package of plastic LED parts.

For information on soldering LEDs, please refer to Application Note 1027.

www.agilent.com/semiconductors

For product information and a complete list of distributors, please go to our web site.

For technical assistance call:

Americas/Canada: +1 (800) 235-0312 or (916) 788 6763

Europe: +49 (0) 6441 92460

China: 10800 650 0017

Hong Kong: (+65) 6271 2451

India, Australia, New Zealand: (+65) 6271 2394

Japan: (+81 3) 3335-8152(Domestic/International), or 0120-61-1280(Domestic Only)

Korea: (+65) 6271 2194

Malaysia, Singapore: (+65) 6271 2054

Taiwan: (+65) 6271 2654

Data subject to change.

Copyright © 2003 Agilent Technologies, Inc.

Obsoletes 5988-8412EN

September 24, 2003

5989-0080EN