

# URZ-Sicherungen

Sicherungseinsätze zylindrische Bauform

# URZ Fuses

Fuse-links cylindrical

Technische Daten nach Baureihen /  
Technical Data Types of Fuses

Technische Daten Sicherungs-Unterteile /  
Technical Data Fuse Bases

**250 V**

**Ø 5 x 20 mm**



Verpackungseinheit / Packing unit: 100 Stück / 100 pieces

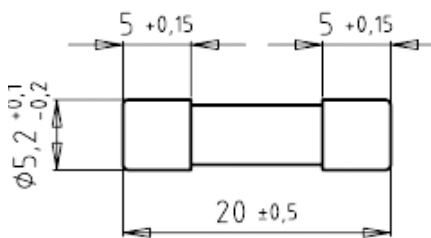

Charakteristik / Class <b>FF</b>	<b>IEC 60 269-4</b> <b>VDE 0636-4</b> <b>UL 248-13</b>
-------------------------------------	--

Bemessungs- spannung Rated Voltage	Artikel Nr. Article No	Größe Size	Bemessungsstrom Rated Current
V			A
400/250/125	70 007 40	5 x 20	0,1-16

Bemessungsausschaltvermögen / Rated breaking capacity **10 kA 400 V**  
**200 kA 250 V**  
**10 kA 125 V**

Bemessungsstrom Rated Current	Artikel Nr. Article No.	Gewicht Weight	Bemessungs- spannung Rated Voltage	Spannungs- abfall Max. Voltage drop	Schmelzintegral Pre-Arcing- I <sup>2</sup> t-Value	Ausschalt- integral Total I <sup>2</sup> t-Value	Leistungs- abgabe Power Loss
A		kg / l	V	mV	A <sup>2</sup> s	A <sup>2</sup> s	W
0,100	70 007 40.0,1	0,001	400	4.000	0,0016	0,0035	0,4
0,125	70 007 40.0,125	0,001	400	3.500	0,0024	0,0053	0,5
0,160	70 007 40.0,16	0,001	400	1.300	0,004	0,009	0,3
0,200	70 007 40.0,2	0,001	400	600	0,01	0,022	0,2
0,250	70 007 40.0,25	0,001	400	550	0,02	0,044	0,2
0,315	70 007 40.0,315	0,001	400	500	0,04	0,09	0,2
0,400	70 007 40.0,4	0,001	400	500	0,07	0,15	0,2
0,500	70 007 40.0,5	0,001	400	550	0,07	0,15	0,3
0,630	70 007 40.0,63	0,001	400	600	0,15	0,34	0,4
0,800	70 007 40.0,8	0,001	400	600	0,32	0,7	0,5
1	70 007 40.1	0,001	400	600	0,32	0,7	0,6
1,25	70 007 40.1,5	0,001	400	400	0,20	0,44	0,5
1,6	70 007 40.1,6	0,001	400	400	0,31	0,68	0,7
2	70 007 40.2	0,001	400	400	0,64	1,4	0,8
2,5	70 007 40.2,5	0,001	400	400	0,88	1,9	1,0
3,15	70 007 40.3,15	0,001	400	400	1,6	3,5	1,3
4	70 007 40.4	0,001	400	350	3,2	7,0	1,4
6,3	70 007 40.6,3*	0,001	250	300	1,6	4,8	2,8
8	70 007 40.8*	0,001	250	300	4,5	14	3
10	70 007 40.10*	0,001	250	300	8,8	26	3,4
12,5	70 007 40.12,5*	0,001	250	200	15	44	4
16	70 007 40.16	0,001	125	130	46	100	3,8



Applikationskoeffizienten / Application coefficients (Weiterführende Informationen siehe Seite 13 / for more information see page 13)

a	A2	B1 max.	B2	CF3
130	0,8	1,25	0,8	0,8

250 V

Ø 5 x 20 mm

cULusE180276

**Zeit/Strom-  
Kennlinien**  
Time-current  
characteristics

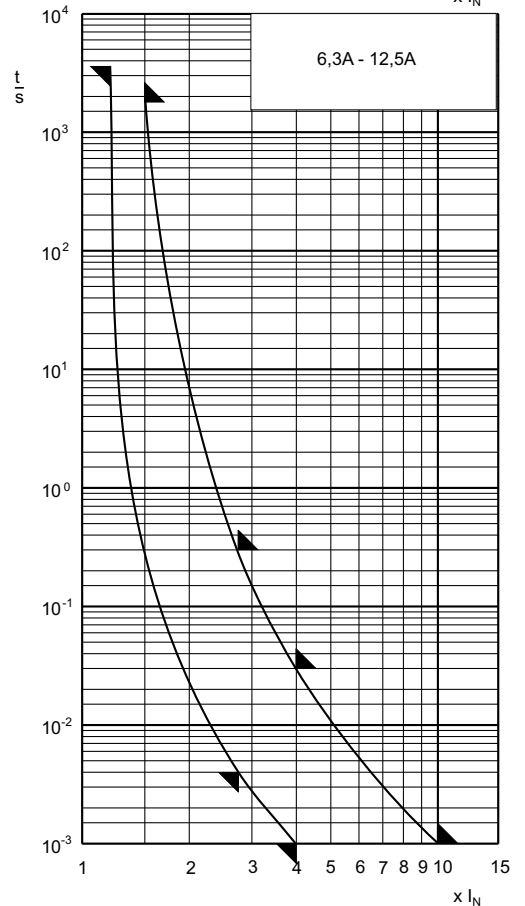
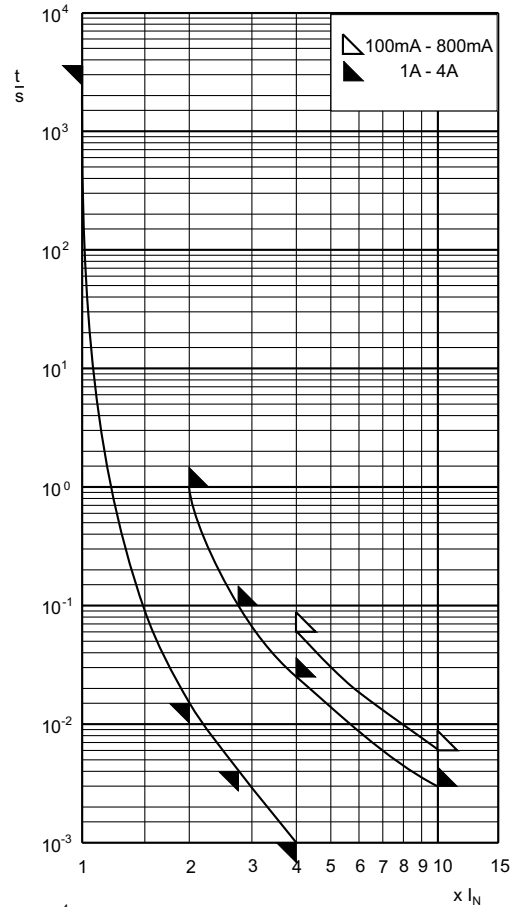

**400 V**

**Ø 6,35 x 32 mm**

 usE180276

Verpackungseinheit / Packing unit: 100 Stück / 100 pieces

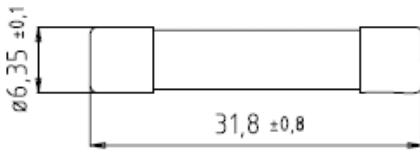

Betriebsklasse / Class  
**gRL (gS)**

**IEC 60 269-4**  
**VDE 0636-4**

Bemessungs- spannung Rated Voltage	Artikel Nr. Article No	Größe Size	Bemessungsstrom Rated Current
V			A
400	70 065 84	6,35 x 32 mm	6,3-20

Bemessungsausschaltvermögen / Rated breaking capacity **120 kA**

Bemessungsstrom Rated Current	Artikel Nr. Article No.	Gewicht Weight	Bemessungs- spannung Rated Voltage	Spannungs- abfall Max. Voltage drop	Schmelzintegral Pre-Arcing- I <sup>2</sup> t-Value	Ausschalt- integral Total I <sup>2</sup> t-Value	Leistungs- abgabe Power Loss
A		kg / 1	V	mV	A <sup>2</sup> s	A <sup>2</sup> s	W
6,3	70 065 84.6,3	0,003	400	190	1,8	11	1,2
8	70 065 84.8	0,003	400	190	3,0	18	1,5
10	70 065 84.10	0,003	400	180	5,1	31	1,8
12,5	70 065 84.12,5	0,003	400	150	12	69	1,9
16	70 065 84.16	0,003	400	150	20	120	2,3
20	70 065 84.20	0,003	400	160	35	210	3,2

Applikationskoeffizienten / Application coefficients (Weiterführende Informationen siehe Seite 13 / for more information see page 13)

a	A2	B1 max.	B2	Cf3
130	0,8	1,25	0,8	0,8

400 V

Ø 6,35 x 32 mm

cULusE180276

Zeit/Strom-  
Kennlinien  
Time-current  
characteristics

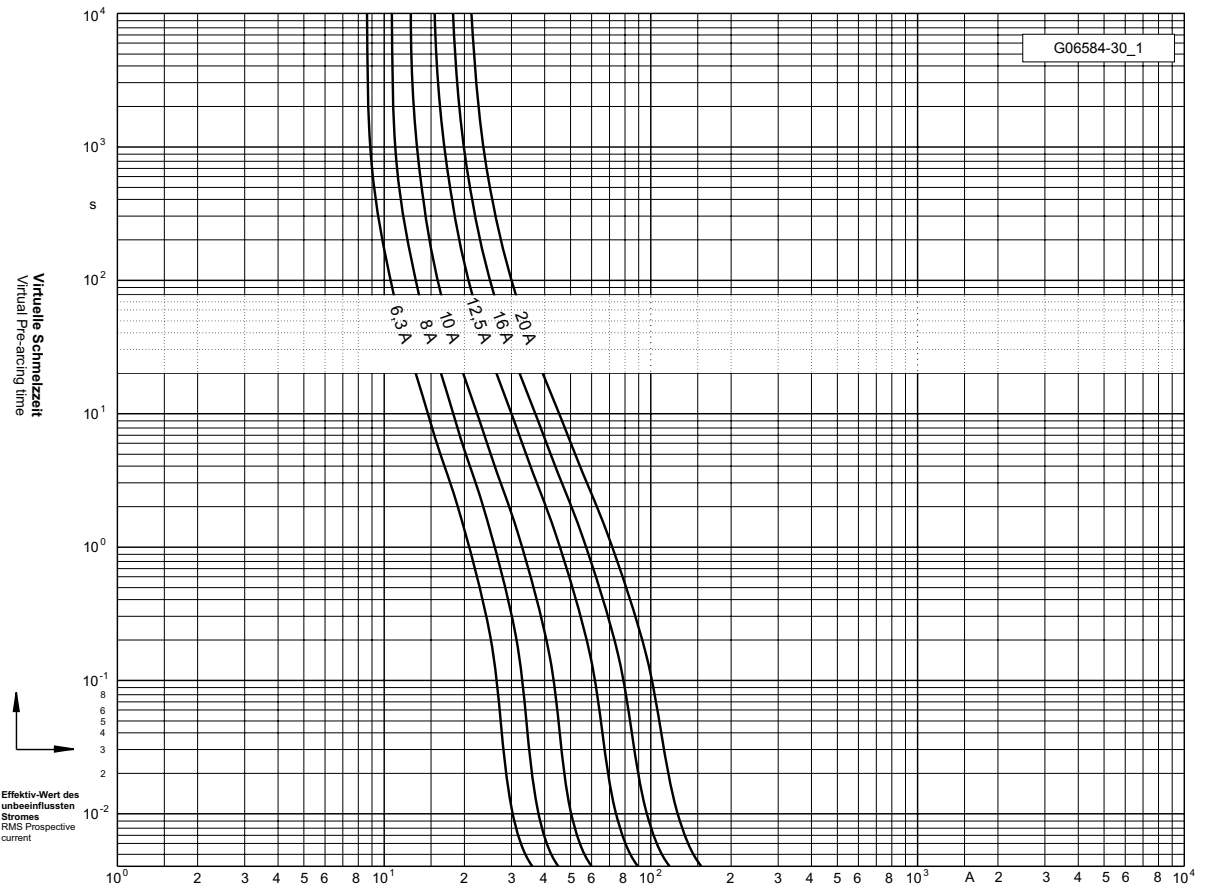

Durchlass-Strom  
Cut-off current

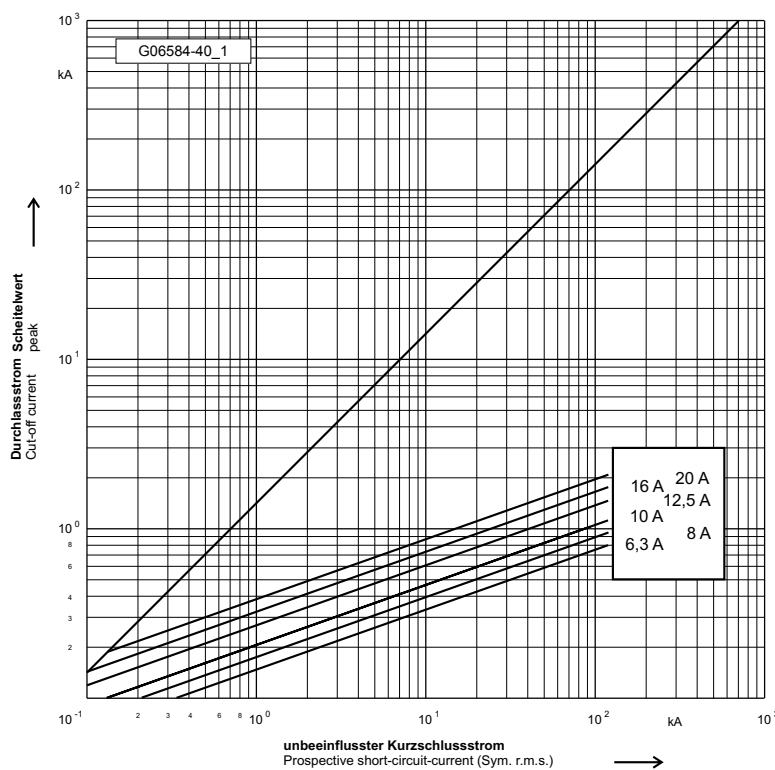

**500-700V Ø 6,35 x 32 mm**

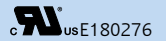

Verpackungseinheit / Packing unit: 100 Stück / 100 pieces

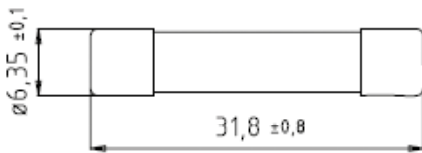

Charakteristik / Class <b>FF</b>	<b>IEC 60 269-4</b> <b>VDE 0636-4</b> <b>UL 248-13</b>
-------------------------------------	--

Bemessungs- spannung Rated Voltage	Artikel Nr. Article No	Größe Size	Bemessungsstrom Rated Current
V			A
700	70 125 40	6,35 x 32	0,1-2
600			2,5-10
500			12,5-25

Bemessungsausschaltvermögen / Rated breaking capacity **50 kA**

Bemessungsstrom Rated Current	Artikel Nr. Article No.	Gewicht Weight	Bemessungs- spannung Rated Voltage	Spannungs- abfall Max. Voltage drop	Schmelzintegral Pre-Arcing- I <sup>2</sup> t-Value	Ausschaltinte- gral Total I <sup>2</sup> t-Value	Leistungs- abgabe Power Loss
A		kg / 1	V	mV	A <sup>2</sup> s	A <sup>2</sup> s	W
0,100	70 125 40.0,1	0,002	700	2.500	0.0009	0.003	0,3
0,125	70 125 40.0,125	0,002	700	2.200	0.0017	0.006	0,3
0,160	70 125 40.0,16	0,002	700	2.000	0.004	0.014	0,4
0,200	70 125 40.0,2	0,002	700	900	0.01	0,035	0,2
0,250	70 125 40.0,25	0,002	700	800	0.02	0,08	0,2
0,315	70 125 40.0,315	0,002	700	700	0.04	0,14	0,3
0,400	70 125 40.0,4	0,002	700	650	0.07	0,25	0,3
0,500	70 125 40.0,5	0,002	700	650	0.12	0,48	0,4
0,630	70 125 40.0,63	0,002	700	650	0.15	0,5	0,5
0,800	70 125 40.0,8	0,002	700	600	0.23	0,8	0,5
1	70 125 40.1	0,002	700	750	0.32	1,1	0,8
1,25	70 125 40.1,25	0,002	700	700	0.20	0,8	0,9
1,6	70 125 40.1,6	0,002	700	650	0.31	1,2	1,1
2	70 125 40.2	0,002	700	650	0.64	2,6	1,4
2,5	70 125 40.2,5	0,002	600	550	1.2	4	1,4
3,15	70 125 40.3,15	0,002	600	500	2.0	7	1,6
4	70 125 40.4	0,002	600	450	5.0	20	1,8
5	70 125 40.5	0,002	600	400	10	40	2,0
6,3	70 125 40.6,3	0,002	600	400	3.0	15	4
8	70 125 40.8	0,002	600	350	6.5	35	4,5
10	70 125 40.10	0,002	600	350	12	60	5
12,5	70 125 40.12,5	0,002	500	300	18	80	7
16	70 125 40.16	0,002	500	300	31	140	9
20	70 125 40.20	0,002	500	300	46	200	11
25	70 125 40.25	0,002	500	230	87	370	11

Applikationskoeffizienten / Application coefficients (Weiterführende Informationen siehe Seite 13 / for more information see page 13)

a	A2	B1 max.	B2	Cf3
130	0,8	1,25	0,8	0,8

**500-700V Ø 6,35 x 32 mm**

c  usE180276

**Zeit/Strom-  
Kennlinien**  
Time-current  
characteristics

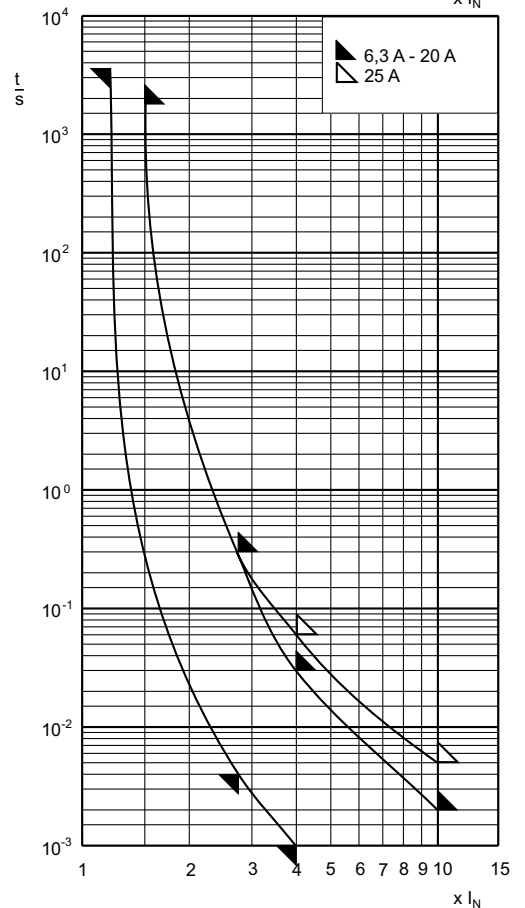
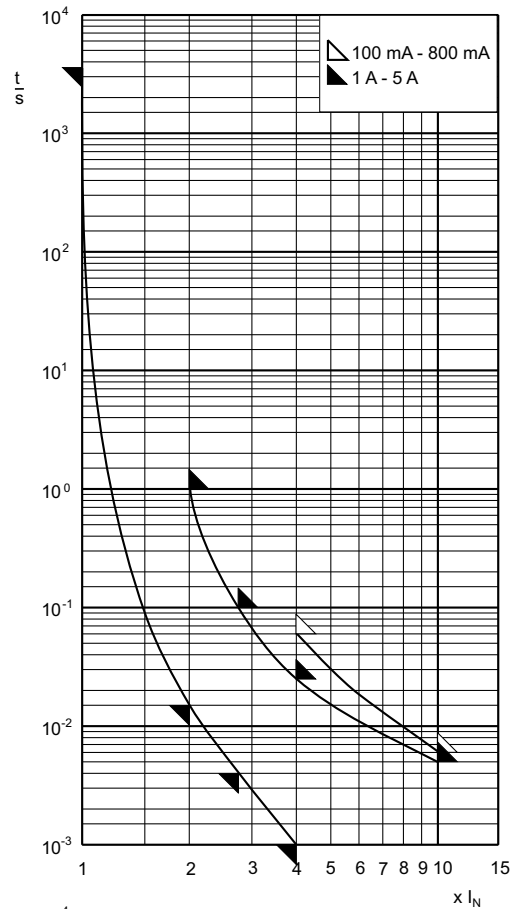

**600 V**

**Ø 10 x 38 mm**

 usE180276

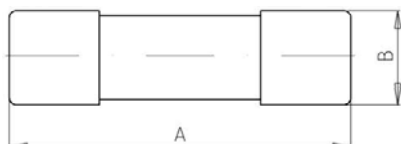

Verpackungseinheit / Packing unit: 10 Stück / 10 pieces

Betriebsklasse / Class  
**aR**

**IEC 60 269-4**  
**VDE 0636-40**  
**UL 248-13**

Bemessungs- spannung Rated Voltage	Artikel Nr. Article No	Größe Size	Bemessungsstrom Rated Current	Länge Length	
V			A	A	B
600	60 033 05	Ø 10 x 38 mm	1-30	38	10

Bemessungsausschaltvermögen / Rated breaking capacity **200 kA (AC 700 V)**

Bemessungsstrom Rated Current	Artikel Nr. Article No.	Gewicht Weight	Bemessungs- spannung Rated Voltage	Approbation Approvals	Schmelzintegral Pre-Arcing- I <sup>2</sup> t-Value	Ausschalt- integral Total I <sup>2</sup> t-Value @ AC 600 V	Leistungs- abgabe Power Loss
A		kg / 1	V	UL-Rec.	A <sup>2</sup> s	A <sup>2</sup> s	W
1	60 033 05.1	0,01	600	-	0,1	0,9	1,0
2	60 033 05.2	0,01	600	-	0,64	5,8	1,8
4	60 033 05.4	0,01	600	-	1,1	6	1,1
5	60 033 05.5	0,01	600	*	1,3	12	1,4
6	60 033 05.6	0,01	600	*	2,0	18	1,6
8	60 033 05.8	0,01	600	*	3	28	1,8
10	60 033 05.10	0,01	600	*	5,1	48	2,1
12	60 033 05.12	0,01	600	*	7,4	63	2,5
16	60 033 05.16	0,01	600	*	13	120	3,0
20	60 033 05.20	0,01	600	*	29	200	3,6
25	60 033 05.25	0,01	600	*	52	420	4,5
30	60 033 05.30	0,01	600	*	81	730	5,8

Applikationskoeffizienten / Application coefficients (Weiterführende Informationen siehe Seite 13 / for more information see page 13)

a	A2	B1 max.	B2	CF3
150	0,6	1,25	0,6	0,8



600 V

Ø 10 x 38 mm

**RU** usE180276

**Zeit/Strom-Kennlinien**  
Time-current characteristics

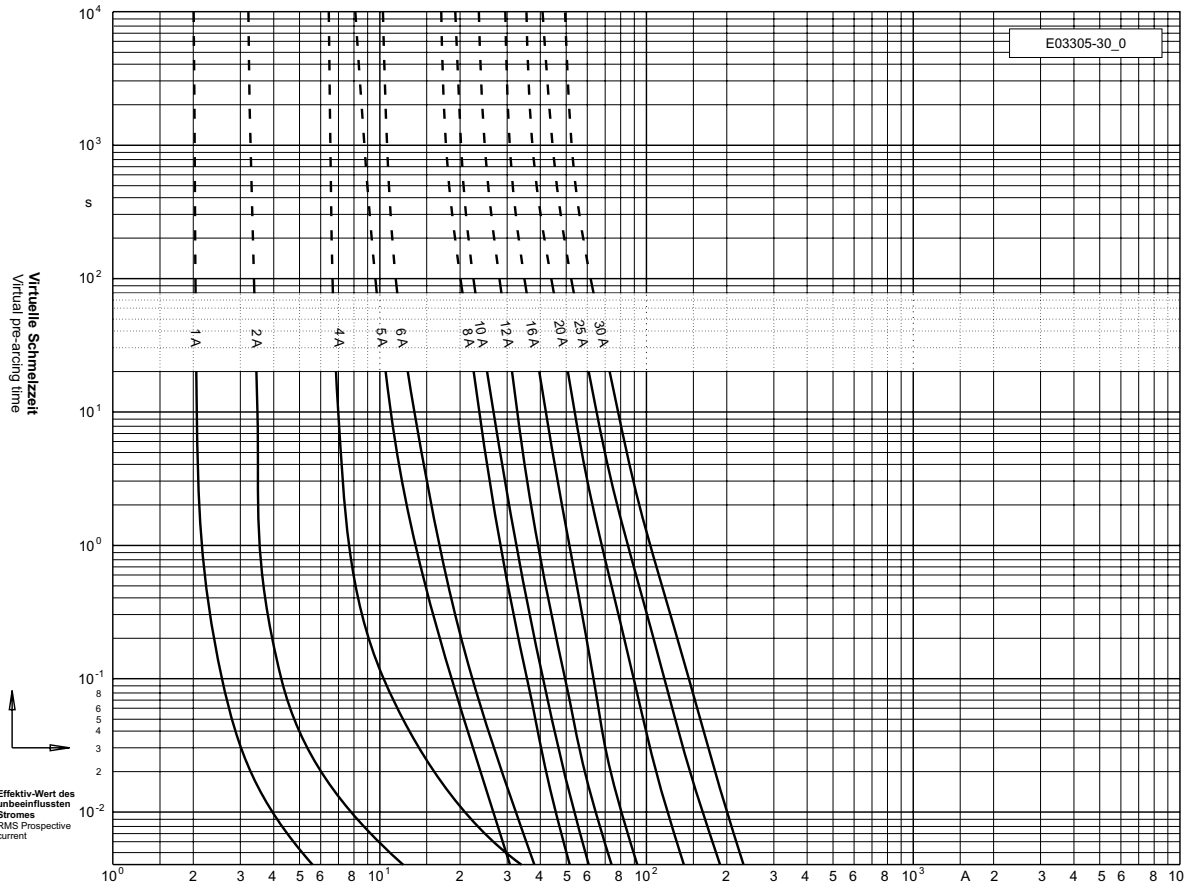

**Durchlass-Strom**  
Cut-off current

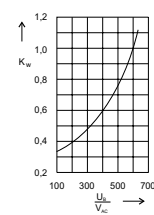
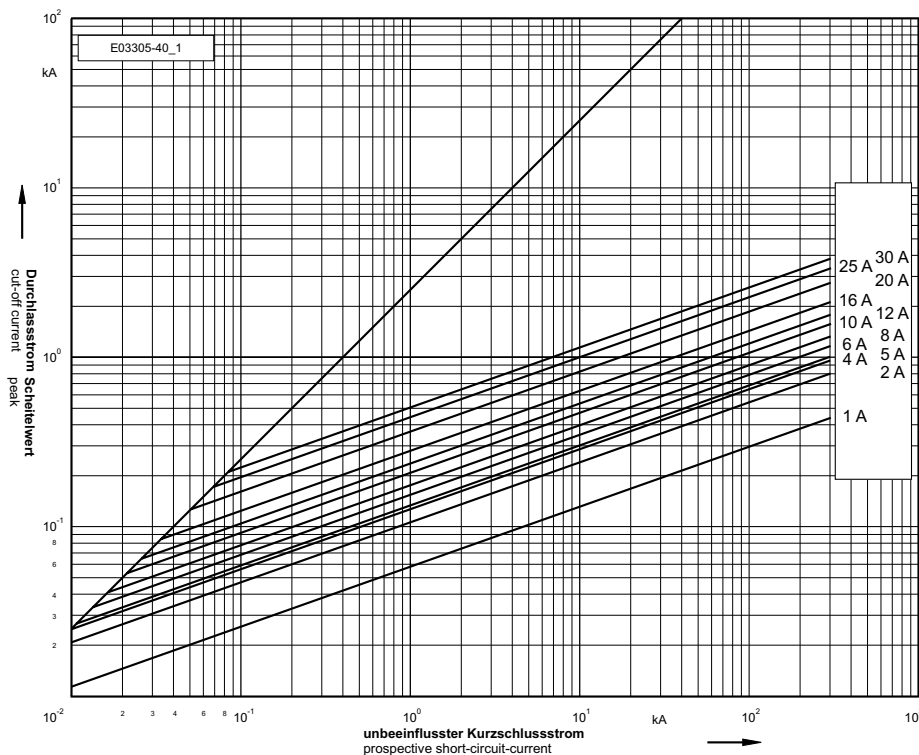

**Umrechnungsfaktor für den Ausschalt  $i^2t$ -Wert**  
Reduction factor for total  $i^2t$ -value

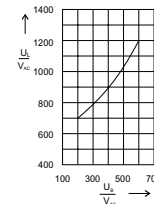

**Schaltspannungsdiagramm**  
Arc Voltage-Diagram

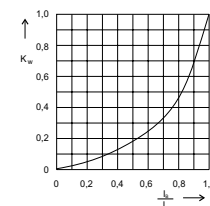

**Umrechnungsfaktor der Leistungsabgabe**  
Reduction factor for power Loss

**600 V**

**Ø 10 x 38 mm**

 usE180276

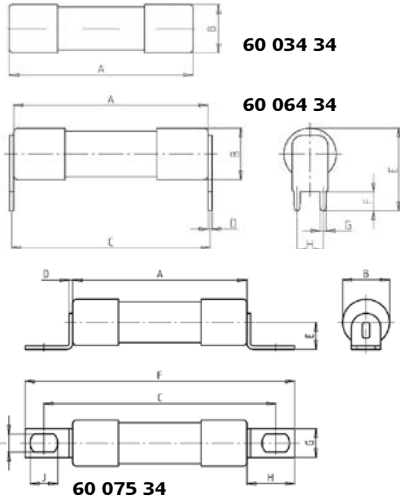

Verpackungseinheit / Packing unit: 10 Stück / 10 pieces

Betriebsklasse / Class <b>gRL (gS)</b>	<b>IEC 60 269-4</b> <b>VDE 0636-40</b> <b>UL 248-13</b>
---	---

Bemessungs- spannung Rated Voltage	Artikel Nr. Article No	Größe Size	Länge Length									
			A	B	C	D	E	F	G	H	I	J
V			mm	mm	mm	mm	mm	mm	mm	mm	mm	mm
600	60 034 34	10	38	10,3	-	-	-	-	-	-	-	-
	60 064 34	x	38	10,3	38,8	0,8	16,4	3,8	1,2	5,1	-	-
	60 075 34	38	38	10,3	50,6	0,8	6,0	58,8	6,4	10,4	4,0	6,0

Bemessungsausschaltvermögen / Rated breaking capacity **200 kA**

Bemessungs- strom Rated Current	Artikel Nr. Article No.			Gewicht Weight	Bemessungs- spannung Rated Voltage		Schmelz- integral	Ausschalt- integral	Leistungs- abgabe Power Loss
	A	mit Einlötpins for PCB mounting	mit Anschlußblaschen with bolted contacts		IEC 60269-4	UL 248-13.	Pre-Arcing- I <sup>2</sup> t-Value	Total I <sup>2</sup> t-Value	
		@ AC 500 V							
				kg / 1	V	V	A <sup>2</sup> s	A <sup>2</sup> s	W
6	60 034 34.6	60 064 34.6	60 075 34.6	0,01	500	600	2,5	20	1
8	60 034 34.8	60 064 34.8	60 075 34.8	0,01	500	600	3,3	36	1,3
10	60 034 34.10	60 064 34.10	60 075 34.10	0,01	500	600	5,1	41	1,1
12	60 034 34.12	60 064 34.12	60 075 34.12	0,01	500	600	8,7	69	1,9
16	60 034 34.16	60 064 34.16	60 075 34.16	0,01	500	600	17	130	2,4
20	60 034 34.20	60 064 34.20	60 075 34.20	0,01	500	600	29	240	3,5
25	60 034 34.25	60 064 34.25	60 075 34.25	0,01	500	600	66	530	3,8
30	60 034 34.30	60 064 34.30	60 075 34.30	0,01	500	600	120	950	4,3

Applikationskoeffizienten / Application coefficients (Weiterführende Informationen siehe Seite 13 / for more information see page 13)

a	A2	B1 max.	B2	CF3
150	1	1,25	0,5	0,8

600 V

Ø 10 x 38 mm

**RU** usE180276

**Zeit/Strom-Kennlinien**  
Time-current characteristics

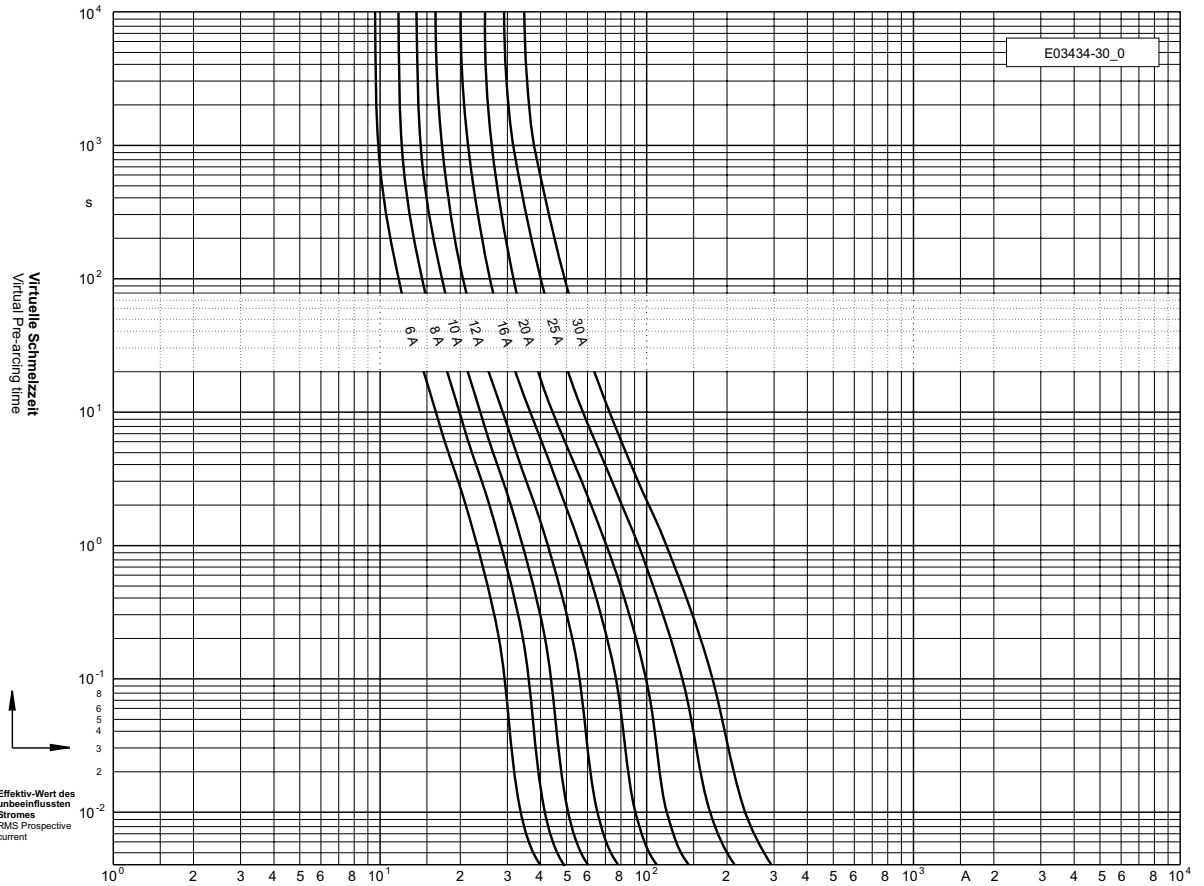

**Durchlass-Strom**  
Cut-off current

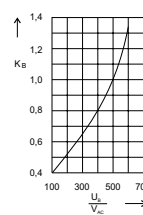
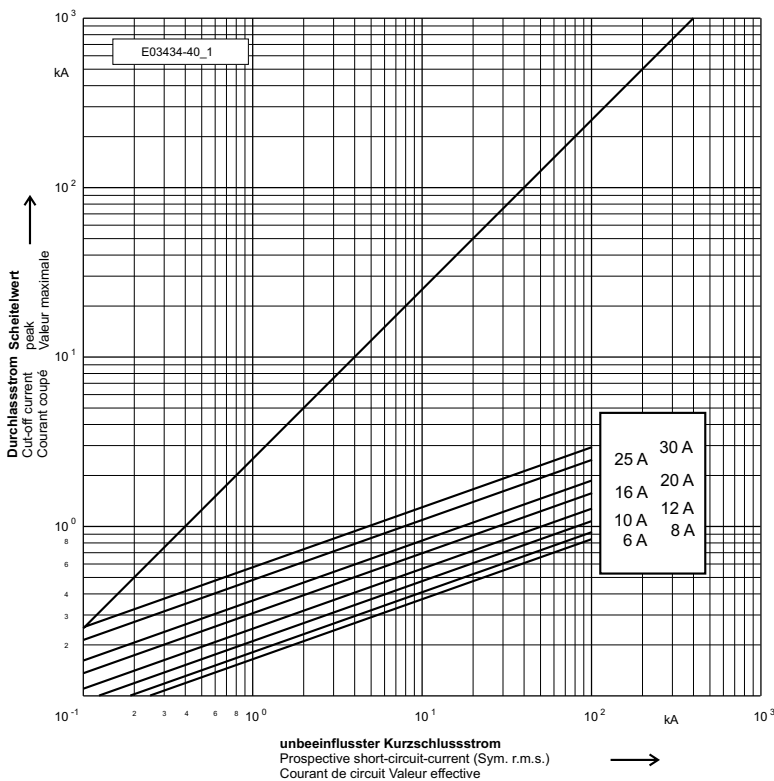

**Umrechnungsfaktor für den Ausschalt i<sup>2</sup>t-Wert**  
Reduction factor for total i<sup>2</sup>t-value

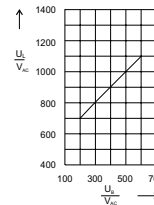

**Schaltspannungsdiagramm**  
Arc Voltage-Diagram

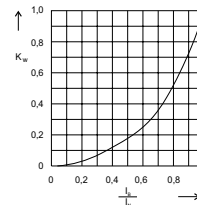

**Umrechnungsfaktor der Leistungsabgabe**  
Reduction factor for power Loss

**600 V**

**Ø 14 x 51 mm**



**50 058 06**

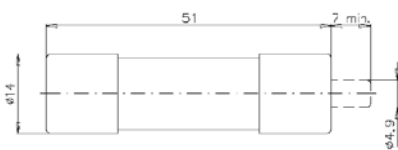

**50 059 06**

Verpackungseinheit / Packing unit: 10 Stück / 10 pieces

Betriebsklasse / Class <b>aR</b>	DIN EN 60269-4 IEC 60 269-4 VDE 0636-4	acc. UL 248-13
-------------------------------------	--	----------------

Bemessungs- spannung Rated Voltage	Artikel Nr. Article No	Größe Size	Bemessungsstrom Rated Current
V			A
500 / 600	50 058 06	Ø 14 x 51 mm	6-50
	50 059 06		

Bemessungsausschaltvermögen / Rated breaking capacity 100 kA

Bemessungsstrom Rated Current	Artikel Nr. Article No.		Gewicht Weight	Bemessungs- spannung Rated Voltage	Schmelz- integral Pre-Arcing- I <sup>2</sup> t-Value	Ausschalt- integral Total I <sup>2</sup> t-Value @ AC 500 V	Leistungs- abgabe Power Loss
	ohne Auslöser without striker	mit Auslöser with striker					
	A						
6	50 058 06.6	50 059 06.6	0,02	600	3	18	1,3
8	50 058 06.8	50 059 06.8	0,02	600	5	27	1,7
10	50 058 06.10	50 059 06.10	0,02	600	8	48	2,4
12	50 058 06.12	50 059 06.12	0,02	600	12	93	2,5
16	50 058 06.16	50 059 06.16	0,02	600	21	150	4,0
20	50 058 06.20	50 059 06.20	0,02	600	32	250	4,6
25	50 058 06.25	50 059 06.25	0,02	600	63	400	6,4
32	50 058 06.32	50 059 06.32	0,02	600	104	680	8,2
40	50 058 06.40	50 059 06.40	0,02	600	140	1.200	9,1
50	50 058 06.50	50 059 06.50	0,02	500	230	1.600	12

Applikationskoeffizienten / Application coefficients (Weiterführende Informationen siehe Seite 13 / for more information see page 13)

a	A2	B1 max.	B2	CF3
170	0,6	1,25	0,6	0,8

600 V

Ø 14 x 51 mm

Zeit/Strom-  
Kennlinien  
Time-current  
characteristics

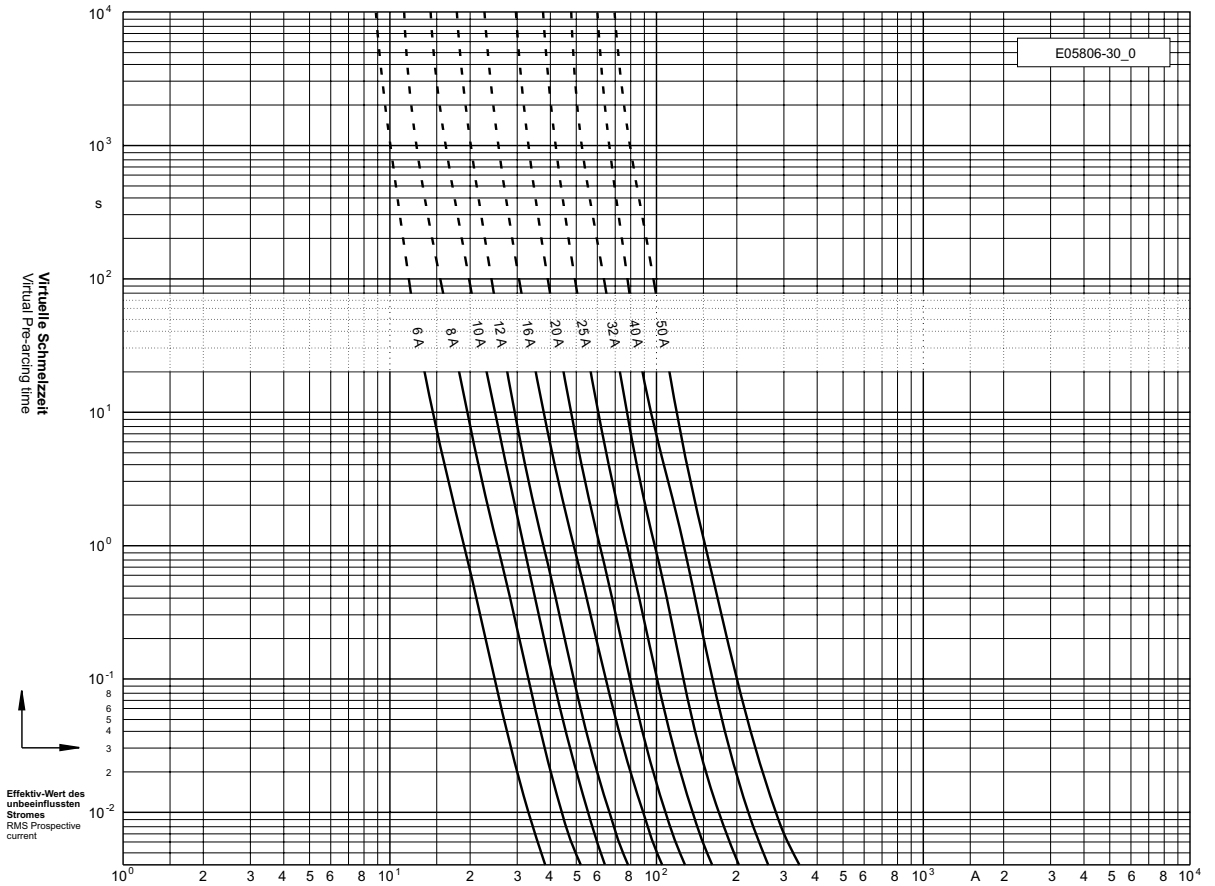

Durchlass-Strom  
Cut-off current

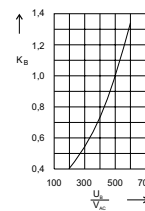
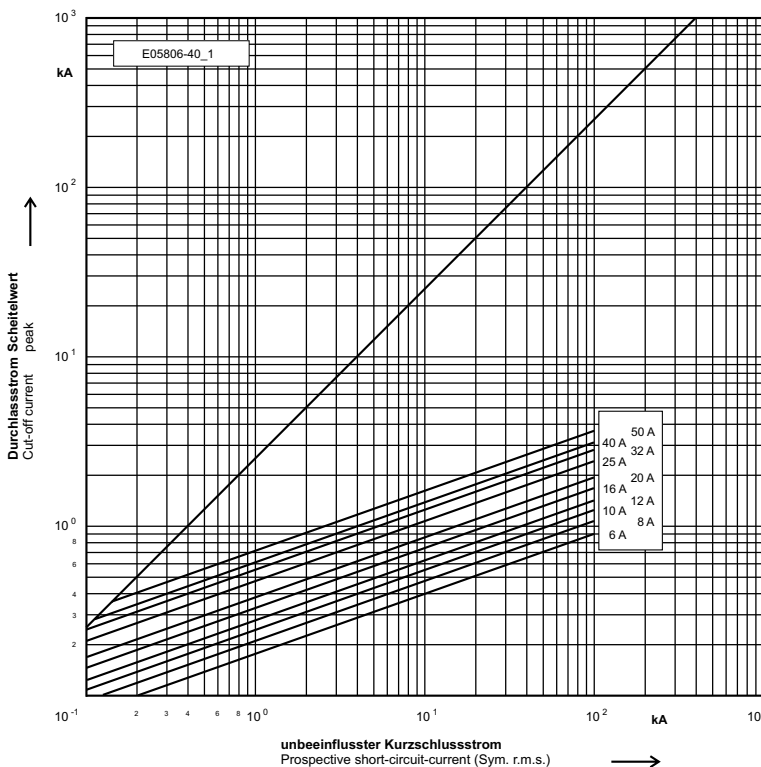

Umrechnungsfaktor  
für den  
Ausschalt  $i^2t$ -Wert  
Reduction factor  
for total  $i^2t$ -value

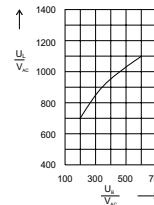

Schaltspannungs-  
diagramm  
Arc Voltage-Diagram

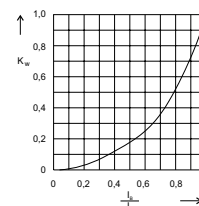

Umrechnungsfaktor  
der  
Leistungsabgabe  
Reduction factor  
for power Loss

**600 V**

**Ø 22 x 58 mm**

Verpackungseinheit / Packing unit: 10 Stück / 10 pieces

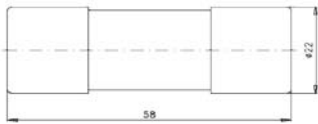

50 060 06

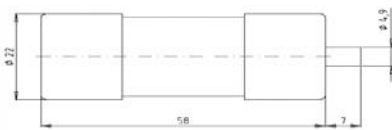

50 061 06

Betriebsklasse / Class <b>aR</b>	DIN EN 60269-4 IEC 60 269-4 VDE 0636-4	acc. UL 248-13
-------------------------------------	--	----------------

Bemessungs- spannung Rated Voltage	Artikel Nr. Article No	Größe Size	Bemessungsstrom Rated Current
V			A
600	50 060 06	Ø 22 x 58 mm	12-100
	50 061 06		

Bemessungsausschaltvermögen / Rated breaking capacity 100 kA

Bemessungsstrom Rated Current	Artikel Nr. Article No.		Gewicht Weight	Bemessungs- spannung Rated Voltage	Schmelzintegral Pre-Arcing- I <sup>2</sup> t-Value	Ausschalt- integral Total I <sup>2</sup> t-Value	Leistungs- abgabe Power Loss
	ohne Auslöser without striker	mit Auslöser with striker					
	A			kg / 1	V	A <sup>2</sup> s	@ AC 500 V A <sup>2</sup> s
12	50 060 06.12	50 061 06.12	0,06	600	16	93	2,1
16	50 060 06.16	50 061 06.16	0,06	600	21	170	3,6
20	50 060 06.20	50 061 06.20	0,06	600	32	250	4,6
25	50 060 06.25	50 061 06.25	0,06	600	63	400	5,3
32	50 060 06.32	50 061 06.32	0,06	600	104	730	8,2
40	50 060 06.40	50 061 06.40	0,06	600	140	1.000	8,6
50	50 060 06.50	50 061 06.50	0,06	600	230	1.800	11
63	50 060 06.63	50 061 06.63	0,06	600	350	2.600	15
80	50 060 06.80	50 061 06.80	0,06	600	740	5.000	18
100	50 060 06.100	50 061 06.100	0,06	600	1.400	10.000	20

Applikationskoeffizienten / Application coefficients (Weiterführende Informationen siehe Seite 13 / for more information see page 13)

a	A2	B1 max.	B2	CF3
170	0,6	1,25	0,6	0,8

600 V

Ø 22 x 58 mm

Zeit/Strom-  
Kennlinien  
Time-current  
characteristics

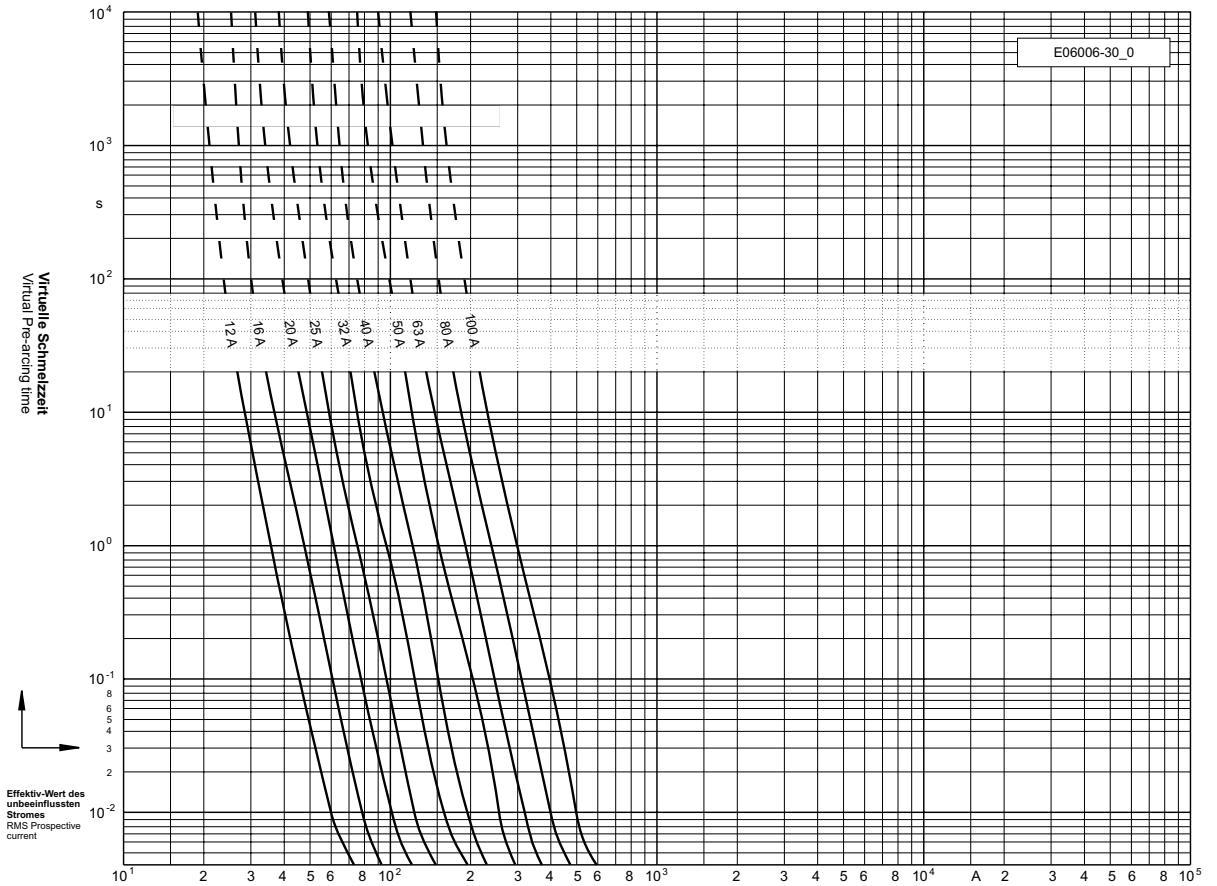

Durchlass-Strom  
Cut-off current

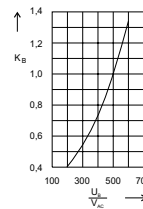
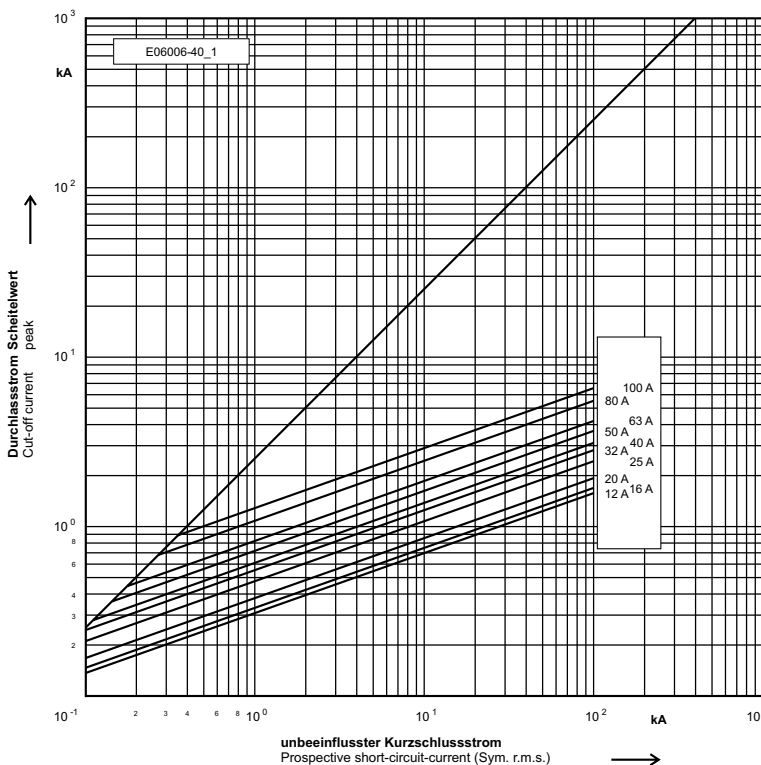

Umrechnungsfaktor  
für den  
Ausschalt  $i^2t$ -Wert  
Reduction factor  
for total  $i^2t$ -value

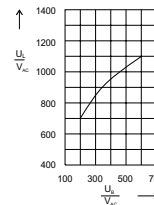

Schaltspannungs-  
diagramm  
Arc Voltage-Diagram

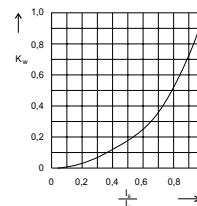

Umrechnungsfaktor  
der  
Leistungsabgabe  
Reduction factor  
for power Loss

**660 V**

**Ø 27 x 60 mm**

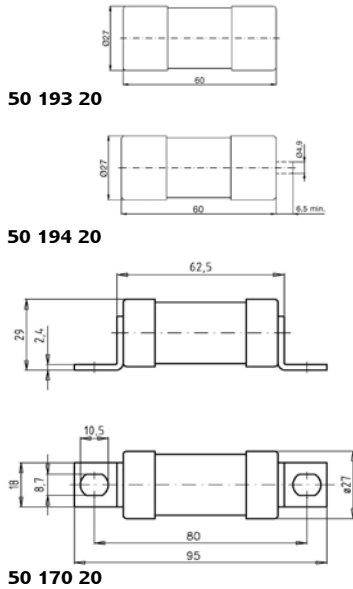

Verpackungseinheit / Packing unit: 10 Stück / 10 pieces

Betriebsklasse / Class <b>aR</b>	<b>IEC 60 269-4</b> <b>VDE 0636-4</b>
-------------------------------------	--

Bemessungs- spannung Rated Voltage	Artikel Nr. Article No	Größe Size	Bemessungsstrom Rated Current
V			A
660	50 193 20	Ø 27 x 60 mm	20-250
	50 194 20		
	50 170 20		

Bemessungsausschaltvermögen / Rated breaking capacity **200 kA (AC 660 V)**

Bemessungsstrom Rated Current	Artikel Nr. Article No.			Gewicht Weight	Bemessungs- spannung Rated Voltage	Schmelz- integral Pre-Arcing- I <sup>2</sup> t-Value	Ausschalt- integral Total I <sup>2</sup> t-Value @ AC 660 V	Leistungs- abgabe Power Loss
	ohne Auslöser without striker	mit Auslöser with striker	mit Anschlußlaschen with bolted contacts					
	A							
20	50 193 20.20	50 194 20.20	50 170 20.20	0,10	660	17	100	8
25	50 193 20.25	50 194 20.25	50 170 20.25	0,10	660	30	180	9
32	50 193 20.32	50 194 20.32	50 170 20.32	0,10	660	67	400	10
40	50 193 20.40	50 194 20.40	50 170 20.40	0,10	660	90	550	13
50	50 193 20.50	50 194 20.50	50 170 20.50	0,10	660	150	900	15
63	50 193 20.63	50 194 20.63	50 170 20.63	0,10	660	330	2.000	16
80	50 193 20.80	50 194 20.80	50 170 20.80	0,10	660	472	2.900	22
100	50 193 20.100	50 194 20.100	50 170 20.100	0,10	660	850	5.400	25
125	50 193 20.125	50 194 20.125	50 170 20.125	0,10	660	1.310	7.900	30
160	50 193 20.160	50 194 20.160	50 170 20.160	0,10	660	2.950	17.700	32
200	50 193 20.200	50 194 20.200	50 170 20.200	0,10	660	5.000	30.000	37
250	50 193 20.250	50 194 20.250	50 170 20.250	0,10	660	8.100	49.000	43

Applikationskoeffizienten / Application coefficients (Weiterführende Informationen siehe Seite 13 / for more information see page 13)

a	A2	B1 max.	B2	CF3
130	0,6	1,25	0,6	0,8



660 V

Ø 27 x 60 mm

Zeit/Strom-Kennlinien  
Time-current characteristics

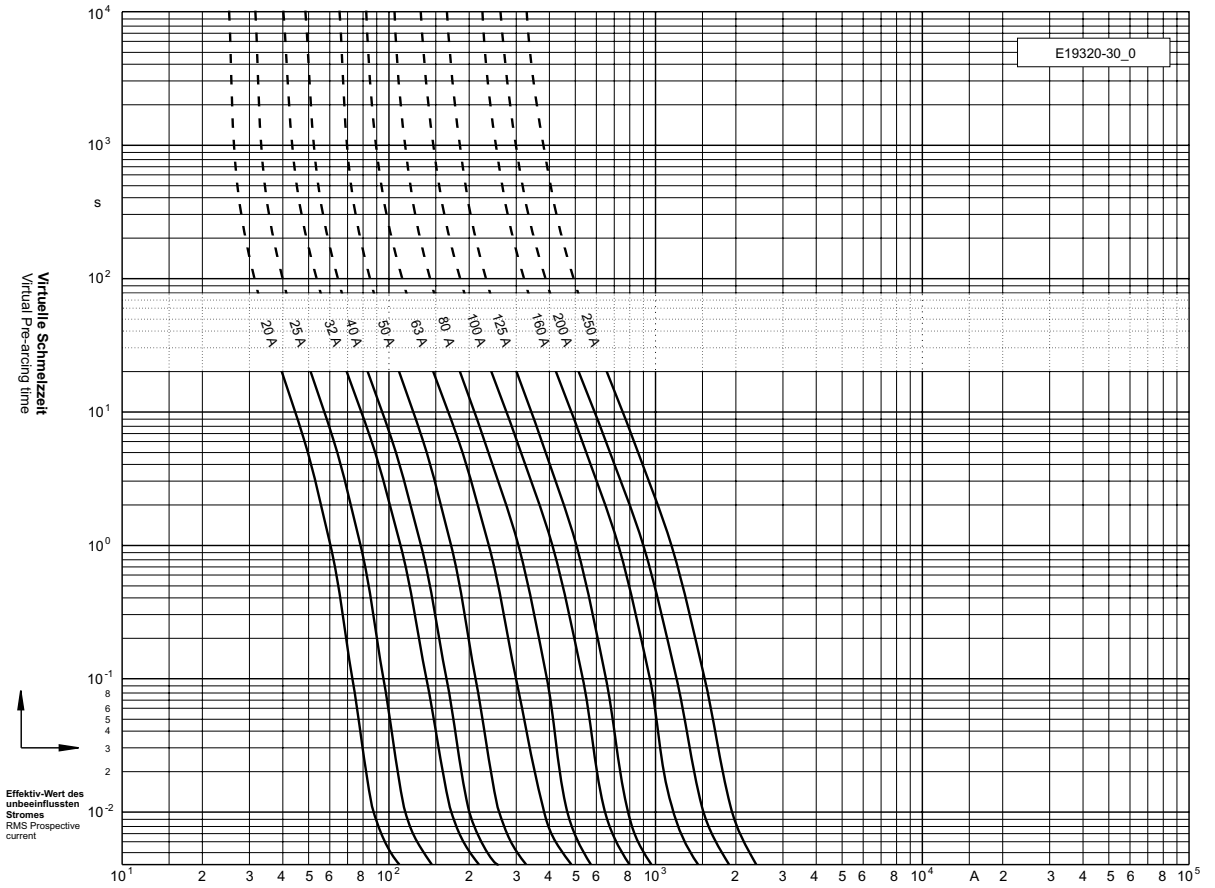

Durchlass-Strom  
Cut-off current

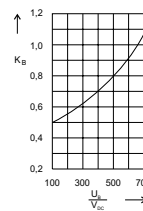
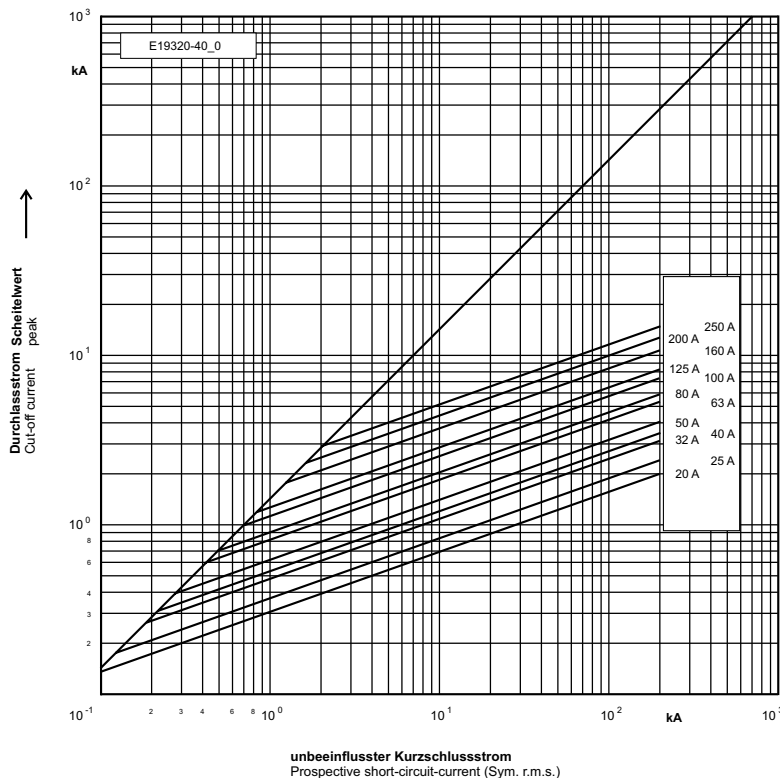

Umrechnungsfaktor für den Ausschalt  $i^2t$ -Wert  
Reduction factor for total  $i^2t$ -value

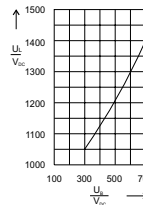

Schaltspannungsdiagramm  
Arc Voltage-Diagram

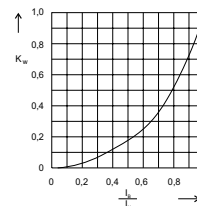

Umrechnungsfaktor der Leistungsabgabe  
Reduction factor for power loss

**690 V**

**Ø 10 x 38 mm**

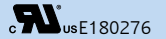

Verpackungseinheit / Packing unit: 10 Stück / 10 pieces

Betriebsklasse / Class <b>gR</b>	<b>DIN EN 60269-4</b> <b>IEC 60 269-4</b> <b>VDE 0636-4</b>	<b>UL 248-13</b>
-------------------------------------	---	------------------

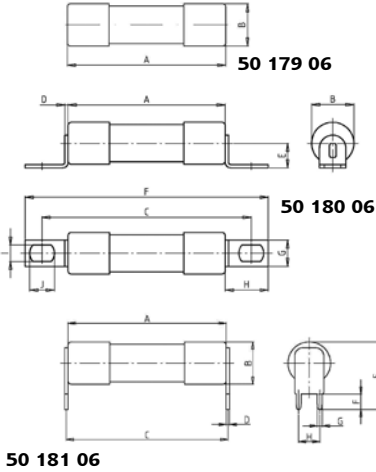

Bemessungs- spannung Rated Voltage	Artikel Article	Größe Size	Länge Length										
			A	B	C	D	E	F	G	H	I	J	
V			mm	mm	mm	mm	mm	mm	mm	mm	mm	mm	mm
690	50 179 06	10	38	10,3	-	-	-	-	-	-	-	-	-
	50 180 06	x	38	10,3	50,6	0,8	6,0	58,8	6,4	10,4	4,0	6,0	
	50 181 06	38	38	10,3	38,8	0,8	16,4	3,8	1,2	5,1	-	-	

Bemessungsausschaltvermögen / Rated breaking capacity **200 kA**

Bemessungs- strom Rated Current	Artikel Nr. Article No.			Gewicht Weight	Bemessungs- spannung Rated Voltage		Schmelz- integral Pre- Arcing- I <sup>2</sup> t-Value	Ausschalt- integral Total I <sup>2</sup> t-Value @ AC 660 V	Leistungs- abgabe Power Loss
		mit Anschlußlaschen with bolted contacts	mit Einlötpins for PCB mounting		IEC 60269-4	UL 248-13			
	A				kg / 1	V			
1	50 179 06.1	50 180 06.1	50 181 06.1	0,01	690	700	0,13	1,6	1,0
2	50 179 06.2	50 180 06.2	50 181 06.2	0,01	690	700	0,64	8,0	1,8
3	50 179 06.3	50 180 06.3	50 181 06.3	0,01	690	700	2,6	32	1,6
4	50 179 06.4	50 180 06.4	50 181 06.4	0,01	690	700	0,8	10	1,1
5	50 179 06.5	50 180 06.5	50 181 06.5	0,01	690	700	2,0	25	1,5
6	50 179 06.6	50 180 06.6	50 181 06.6	0,01	690	700	3,0	38	1,8
8	50 179 06.8	50 180 06.8	50 181 06.8	0,01	690	700	3,1	39	1,8
10	50 179 06.10	50 180 06.10	50 181 06.10	0,01	690	700	5,1	64	2,3
12	50 179 06.12	50 180 06.12	50 181 06.12	0,01	690	700	7,4	93	2,8
16	50 179 06.16	50 180 06.16	50 181 06.16	0,01	690	700	13	164	3,7
20	50 179 06.20	50 180 06.20	50 181 06.20	0,01	690	700	29	360	4,7
25	50 179 06.25	50 180 06.25	50 181 06.25	0,01	690	700	52	650	5,4
30	50 179 06.30	50 180 06.30	50 181 06.30	0,01	690	700	81	1.010	6,4

Applikationskoeffizienten / Application coefficients (Weiterführende Informationen siehe Seite 13 / for more information see page 13)

a	A2	B1 max.	B2	CF3
150	0,6	1,25	0,5	0,8

690 V

Ø 10 x 38 mm

**RU** usE180276

Zeit/Strom-  
Kennlinien  
Time-current  
characteristics

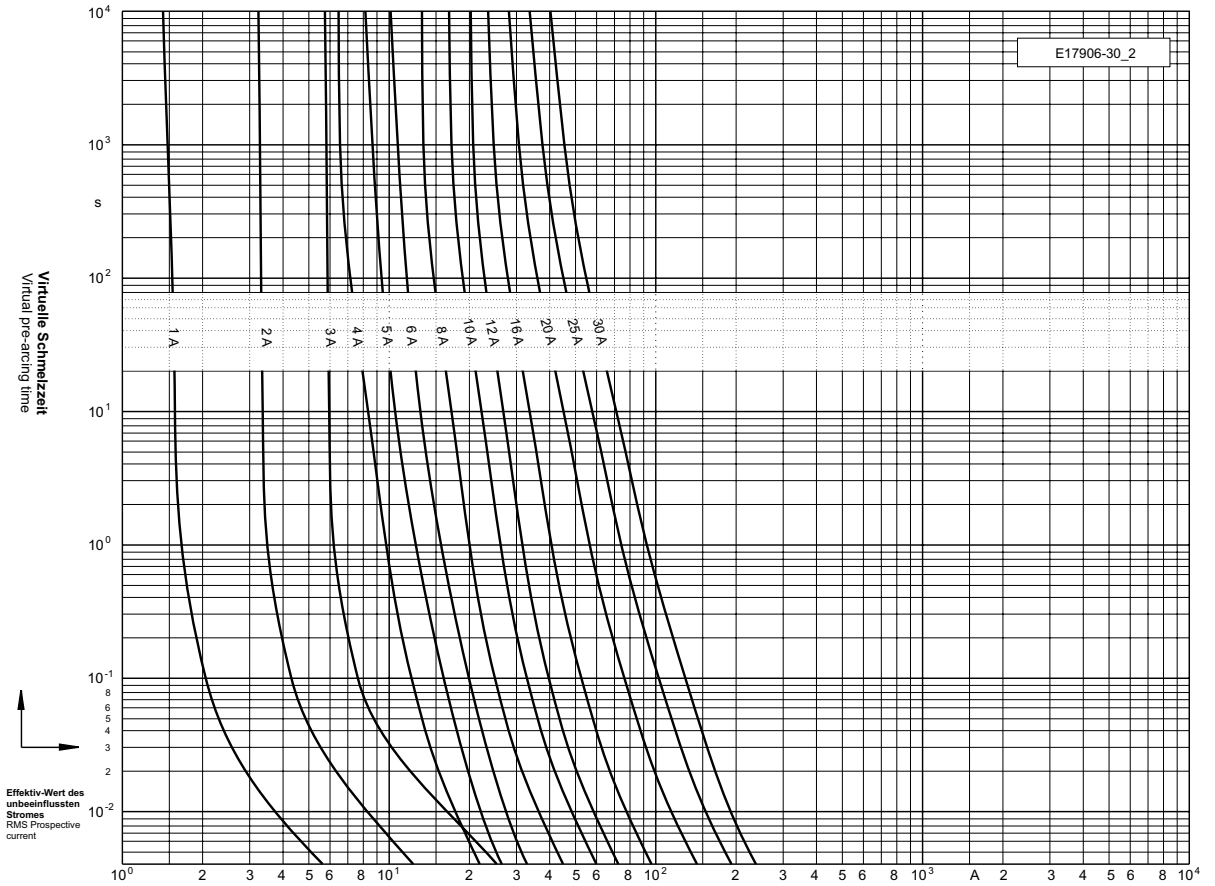

Durchlass-Strom  
Cut-off current

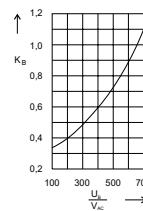
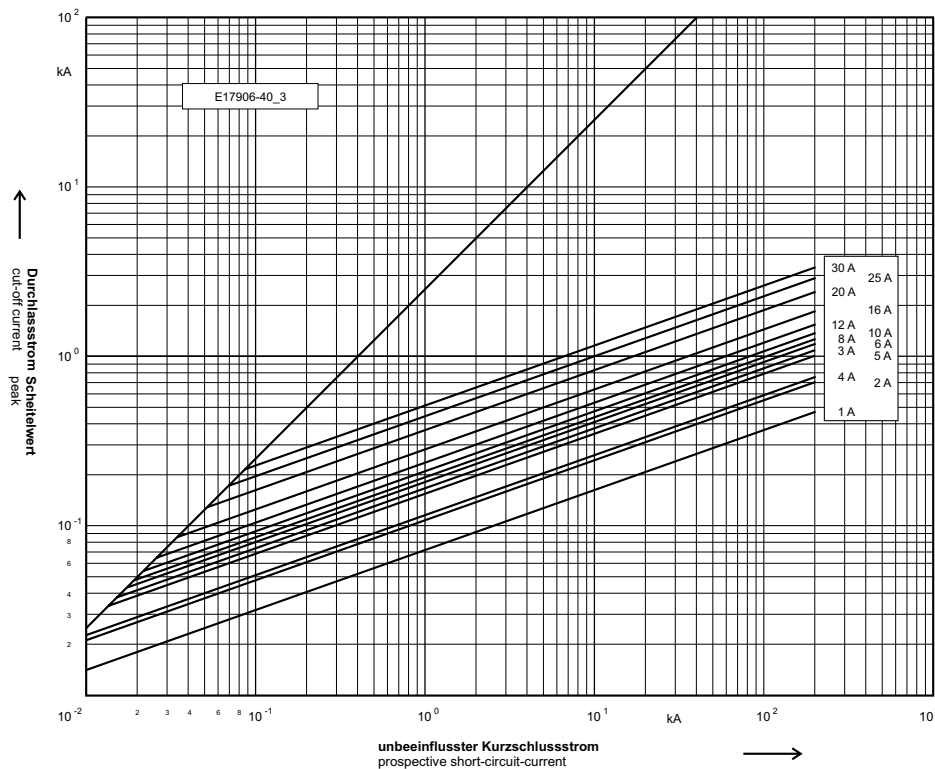

Umrechnungsfaktor  
für den  
Ausschalt  $i^2t$ -Wert  
Reduction factor  
for total  $i^2t$ -value

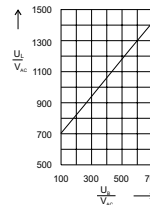

Schaltspannungs-  
diagramm  
Arc Voltage-Diagramm

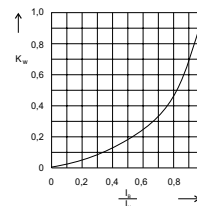

Umrechnungsfaktor  
der  
Leistungsabgabe  
Reduction factor  
for power Loss

**690 V**

**Ø 14 x 51 mm**

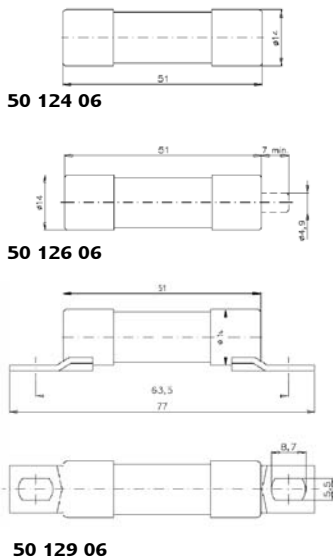
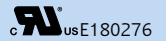

Verpackungseinheit / Packing unit: 10 Stück / 10 pieces

Betriebsklasse / Class <b>gR</b>	<b>IEC 60 269-4</b> <b>VDE 0636-4</b>	<b>UL 248-13</b>
-------------------------------------	--	------------------

Bemessungs- spannung Rated Voltage	Artikel Nr. Article No	Größe Size	Bemessungsstrom Rated Current
V			A
690	50 124 06	Ø 14 x 51 mm	1-50
	50 126 06		
	50 129 06		

Bemessungsausschaltvermögen / Rated breaking capacity 200 kA

Bemessungs- strom Rated Current	Artikel Nr. Article No.			Gewicht Weight	Bemessungs- spannung Rated Voltage		Schmelz- integral Pre- Arcing- I <sup>2</sup> t-Value	Ausschalt- integral Total I <sup>2</sup> t-Value @ AC 660 V	Leistungs- abgabe Power Loss
	ohne Auslöser without striker	mit Auslöser with striker	ohne Auslöser without striker Stichmaß / fixing center 63,5 mm		IEC 60269-4	UL 248-13			
	A				V	V			
1	50 124 06.1	50 126 06.1	50 129 06.1	0,02	690	-	0,6	1,9	0,5
2	50 124 06.2	50 126 06.2	50 129 06.2	0,02	690	-	2,6	7,7	1,0
3	50 124 06.3	50 126 06.3	50 129 06.3	0,02	690	-	5	15	1,5
4	50 124 06.4	50 126 06.4	50 129 06.4	0,02	690	-	10	30	2,0
6	50 124 06.6	50 126 06.6	50 129 06.6	0,02	690	700	2,9	18	1,3
8	50 124 06.8	50 126 06.8	50 129 06.8	0,02	690	700	5,1	28	1,7
10	50 124 06.10	50 126 06.10	50 129 06.10	0,02	690	700	7,7	39	2,6
12	50 124 06.12	50 126 06.12	50 129 06.12	0,02	690	700	8,1	75	3,1
16	50 124 06.16	50 126 06.16	50 129 06.16	0,02	690	700	11	115	4,7
20	50 124 06.20	50 126 06.20	50 129 06.20	0,02	690	700	21	190	6,0
25	50 124 06.25	50 126 06.25	50 129 06.25	0,02	690	700	32	340	7,6
32	50 124 06.32	50 126 06.32	50 129 06.32	0,02	690	700	63	620	9,5
40	50 124 06.40	50 126 06.40	50 129 06.40	0,02	690	700	140	1.050	10
50	50 124 06.50	50 126 06.50	50 129 06.50	0,02	690	700	250	1.900	12

Applikationskoeffizienten / Application coefficients (Weiterführende Informationen siehe Seite 13 / for more information see page 13)

a	A2	B1 max.	B2	CF3
170	0,6	1,25	0,6	0,8

690 V

Ø 14 x 51 mm

**RU** usE180276

Zeit/Strom-  
Kennlinien  
Time-current  
characteristics

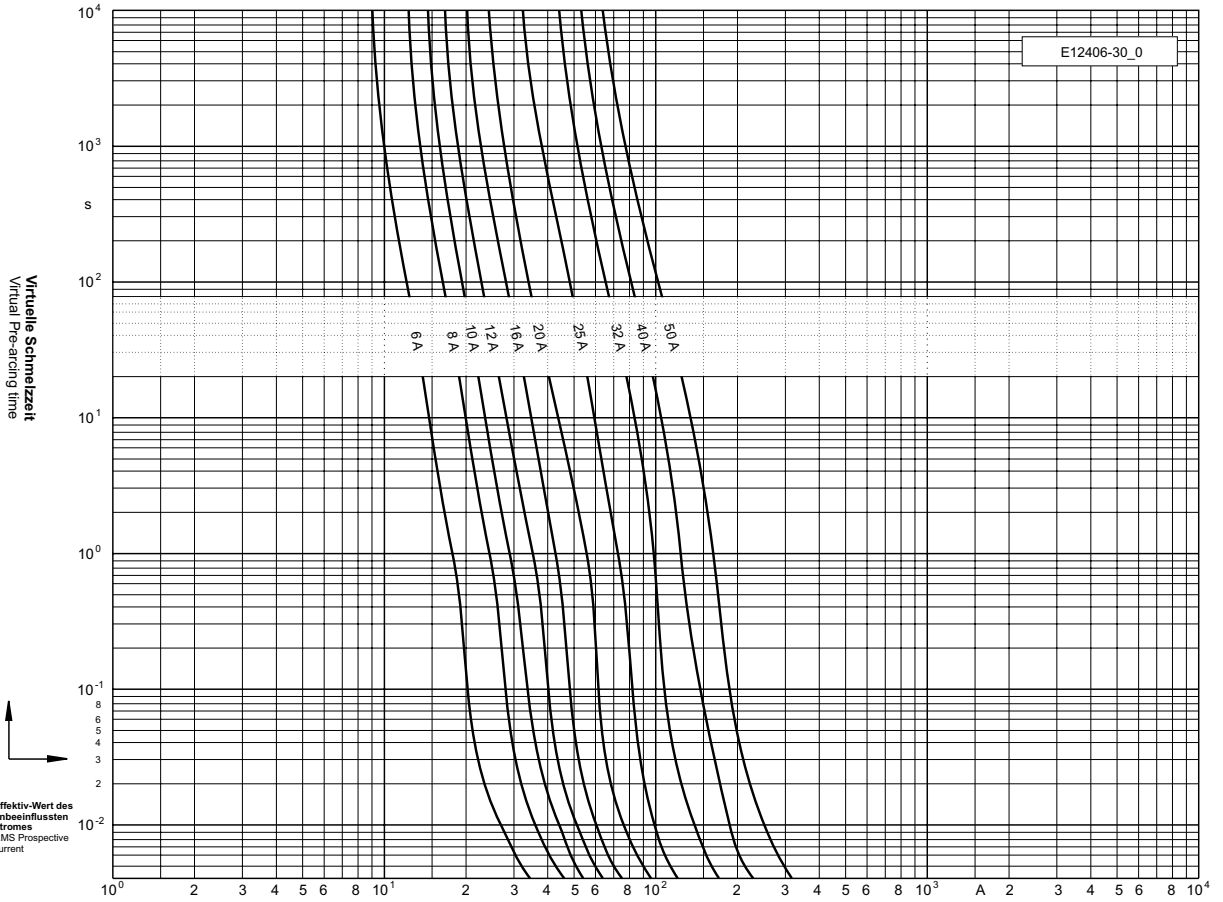

Durchlass-Strom  
Cut-off current

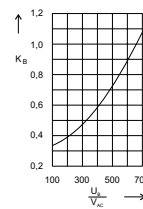
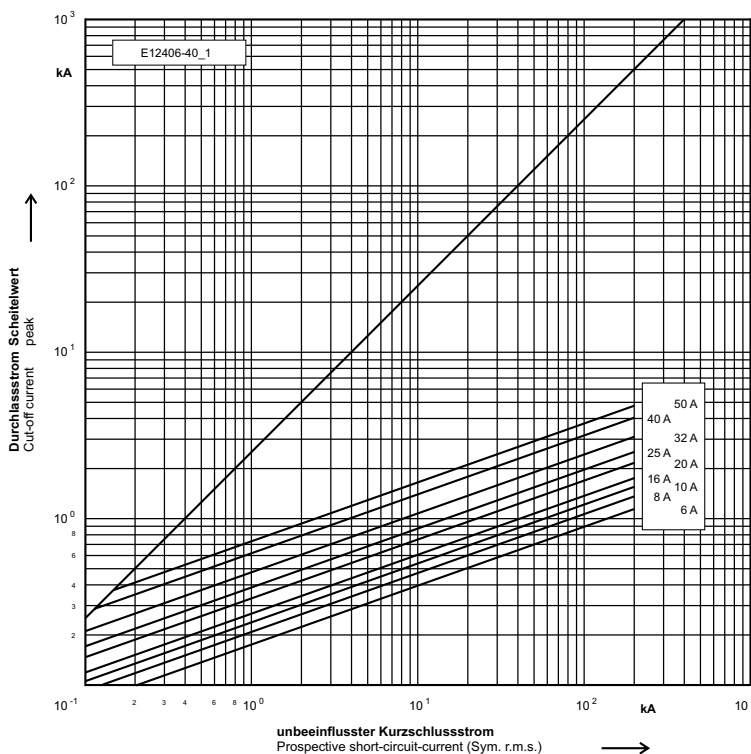

Umrechnungsfaktor  
für den  
Ausschalt  $i^2t$ -Wert  
Reduction factor  
for total  $i^2t$ -value

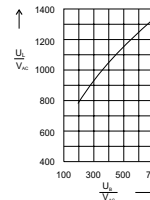

Schaltspannungs-  
diagramm  
Arc Voltage-Diagram

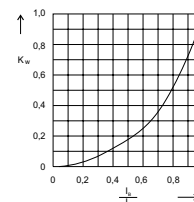

Umrechnungsfaktor  
der  
Leistungsabgabe  
Reduction factor  
for power loss

**690 V**

**Ø 14 x 51 mm**

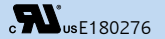

Verpackungseinheit / Packing unit: 10 Stück / 10 pieces

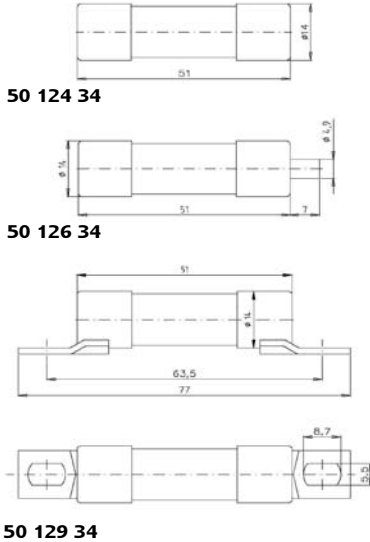

Betriebsklasse / Class <b>gRL (gS)</b>	<b>IEC 60 269-4</b> <b>VDE 0636-4</b> <b>UL 248-13</b>
---	--

Bemessungs- spannung Rated Voltage	Artikel Nr. Article No	
V		
690 / 700	50 124 34	ohne Auslöser without striker
	50 126 34	mit Auslöser ( min. Ansprechspg. 10V) with striker (min. operating Voltage 10V)
	50 129 34	ohne Auslöser, Stichmaß 63 mm without striker, fixing center 63 mm

**Bemessungsausschaltvermögen / Rated breaking capacity 200 kA AC 700 V**  
**30 kA DC 440 V**  
**L/R = 30 mS**

Bemessungs- strom Rated Current	Artikel Nr. Article No.			Gewicht Weight	Bemessungsspannung Rated Voltage			Schmelz- integral Pre- Arcing- I <sup>2</sup> t-Value	Ausschaltintegral Total I <sup>2</sup> t-Value		Leistungs- abgabe Power Loss
	ohne Auslöser without striker	mit Auslöser with striker	ohne Auslöser without striker Stichmaß / fixing center 63,5 mm		IEC 60269-4	UL 248-13	DC		@ AC 690 V	@ DC 440 V L/R=30mS	
	A				kg / 1	V	V		V	A <sup>2</sup> s	
10	50 124 34.10	50 126 34.10	50 129 34.10	0,02	690	700	440	8	60	70	1,9
12	50 124 34.12	50 126 34.12	50 129 34.12	0,02	690	700	440	12	90	105	2,3
16	50 124 34.16	50 126 34.16	50 129 34.16	0,02	690	700	440	25	190	210	2,8
20	50 124 34.20	50 126 34.20	50 129 34.20	0,02	690	700	440	46	340	400	3,0
25	50 124 34.25	50 126 34.25	50 129 34.25	0,02	690	700	440	100	740	850	3,2
30	50 124 34.30	50 126 34.30	50 129 34.30	0,02	690	700	440	190	1.400	1.600	3,8
32	50 124 34.32	50 126 34.32	50 129 34.32	0,02	690	700	440	250	1.900	2.100	4,0
35	50 124 34.35	50 126 34.35	50 129 34.35	0,02	690	700	440	370	2.800	3.150	4,2
40	50 124 34.40	50 126 34.40	50 129 34.40	0,02	690	700	440	420	3.100	3.600	4,4

Applikationskoeffizienten / Application coefficients (Weiterführende Informationen siehe Seite 13 / for more information see page 13)

a	A2	B1 max.	B2	Cf3
130	1,0	1,25	0,5	0,8

**690 V**

**Ø 14 x 51 mm**

**usE180276**

**Zeit/Strom-Kennlinien**  
Time-current characteristics

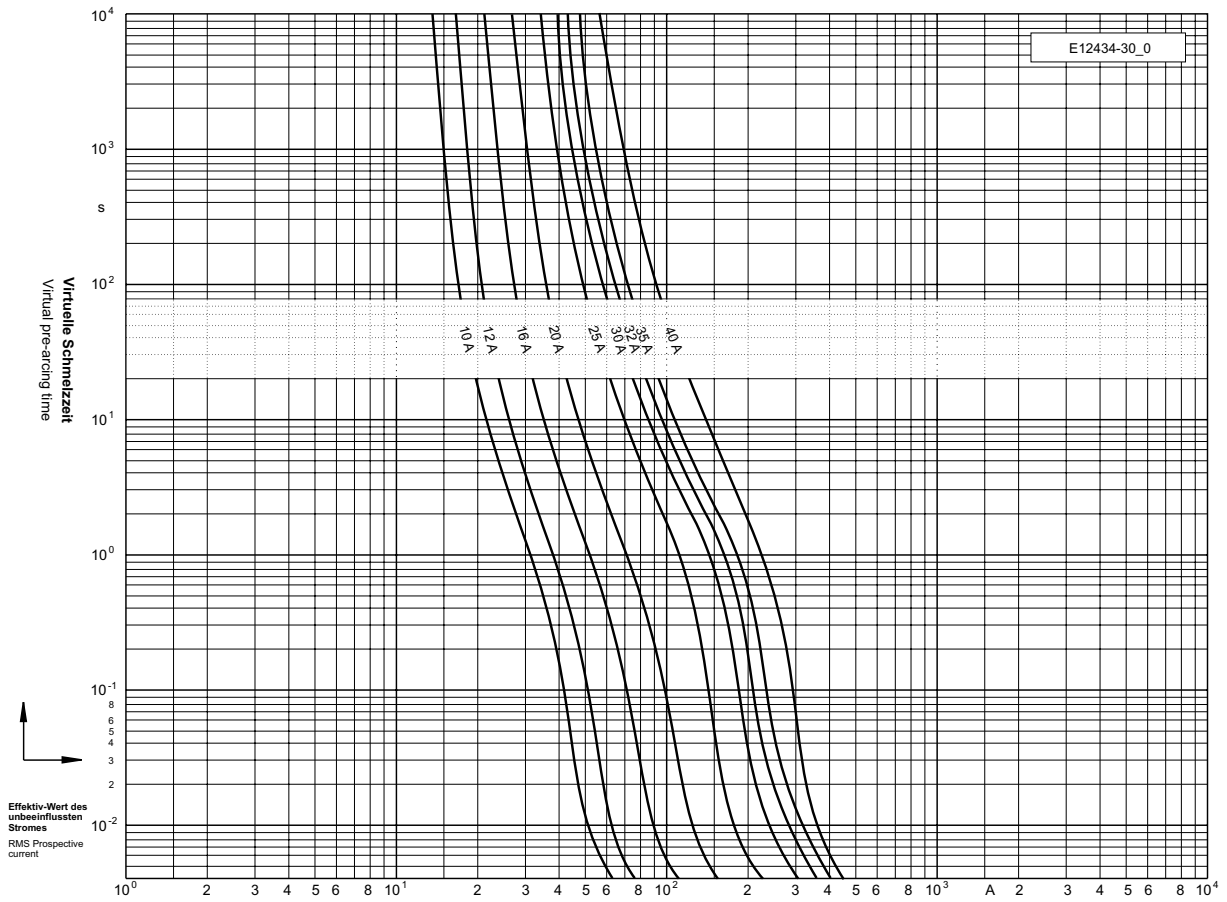

**Durchlass-Strom**  
Cut-off current

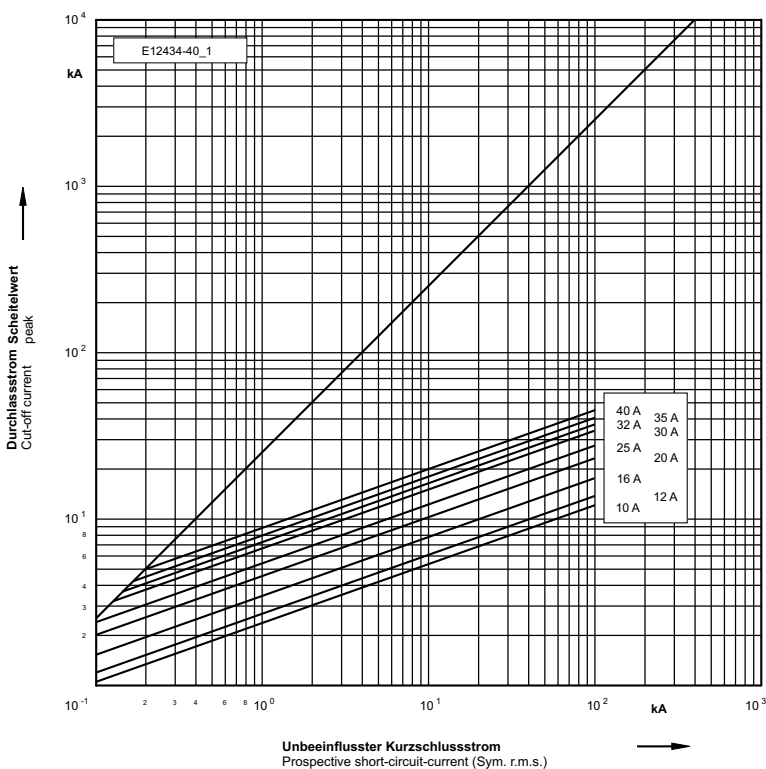

**690 V**

**Ø 22 x 58 mm**

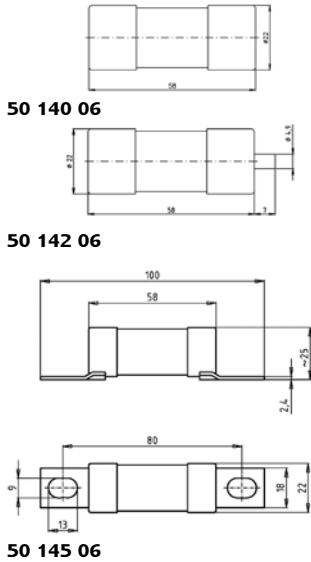
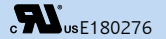

Verpackungseinheit / Packing unit: 10 Stück / 10 pieces

Betriebsklasse / Class ≤ 100 A: gR > 100 A: aR	DIN EN 60269-4 IEC 60 269-4 VDE 0636-4	UL 248-13
--	--	-----------

Bemessungsspannung Rated Voltage	Artikel Nr. Article No	
V		
690 / 700	50 140 06	ohne Auslöser without striker
	50 142 06	mit Auslöser ( min. Ansprechspg. 10V) with striker (min. operating Voltage 10V)
	50 145 06	ohne Auslöser, Stichmaß 80 mm without striker, fixing center 80 mm

Bemessungsausschaltvermögen / Rated breaking capacity 200 kA AC 700 V

Bemessungsstrom Rated Current	Artikel Nr. Article No.			Gewicht Weight	Bemessungsspannung Rated Voltage		Schmelzintegral Pre-Arcing- I <sup>2</sup> t-Value	Ausschaltintegral Total I <sup>2</sup> t-Value	Leistungsabgabe Power Loss
	ohne Auslöser without striker	mit Auslöser with striker	ohne Auslöser without striker Stichmaß / fixing center 80 mm		IEC 60269-4	UL 248-13			
	A				V	V			
6	50 140 06.6	50 142 06.6	50 145 06.6	0,06	690	700	2	10	3,0
8	50 140 06.8	50 142 06.8	50 145 06.8	0,06	690	700	4	20	3,5
10	50 140 06.10	50 142 06.10	50 145 06.10	0,06	690	700	6	30	4,0
12	50 140 06.12	50 142 06.12	50 145 06.12	0,06	690	700	8	35	4,8
16	50 140 06.16	50 142 06.16	50 145 06.16	0,06	690	700	12	53	5,5
20	50 140 06.20	50 142 06.20	50 145 06.20	0,06	690	700	21	91	6,0
25	50 140 06.25	50 142 06.25	50 145 06.25	0,06	690	700	32	140	7,2
32	50 140 06.32	50 142 06.32	50 145 06.32	0,06	690	700	63	315	9,6
40	50 140 06.40	50 142 06.40	50 145 06.40	0,06	690	700	140	610	12
50	50 140 06.50	50 142 06.50	50 145 06.50	0,06	690	700	210	910	15
63	50 140 06.63	50 142 06.63	50 145 06.63	0,06	690	700	510	2.260	16
80	50 140 06.80	50 142 06.80	50 145 06.80	0,06	690	700	1.000	4.400	18
100	50 140 06.100	50 142 06.100	50 145 06.100	0,06	690	700	2.050	8.900	19
125	50 140 06.125	50 142 06.125	50 145 06.125	0,06	690	-	3.000	22.000	23
135	50 140 06.135	50 142 06.135	50 145 06.135	0,06	690	-	3.500	25.000	26

Applikationskoeffizienten / Application coefficients (Weiterführende Informationen siehe Seite 13 / for more information see page 13)

a	A2	B1 max.	B2	CF3
170	0,6	1,25	0,6	0,8



690 V

Ø 22 x 58 mm

**RU** usE180276

Zeit/Strom-  
Kennlinien  
Time-current  
characteristics

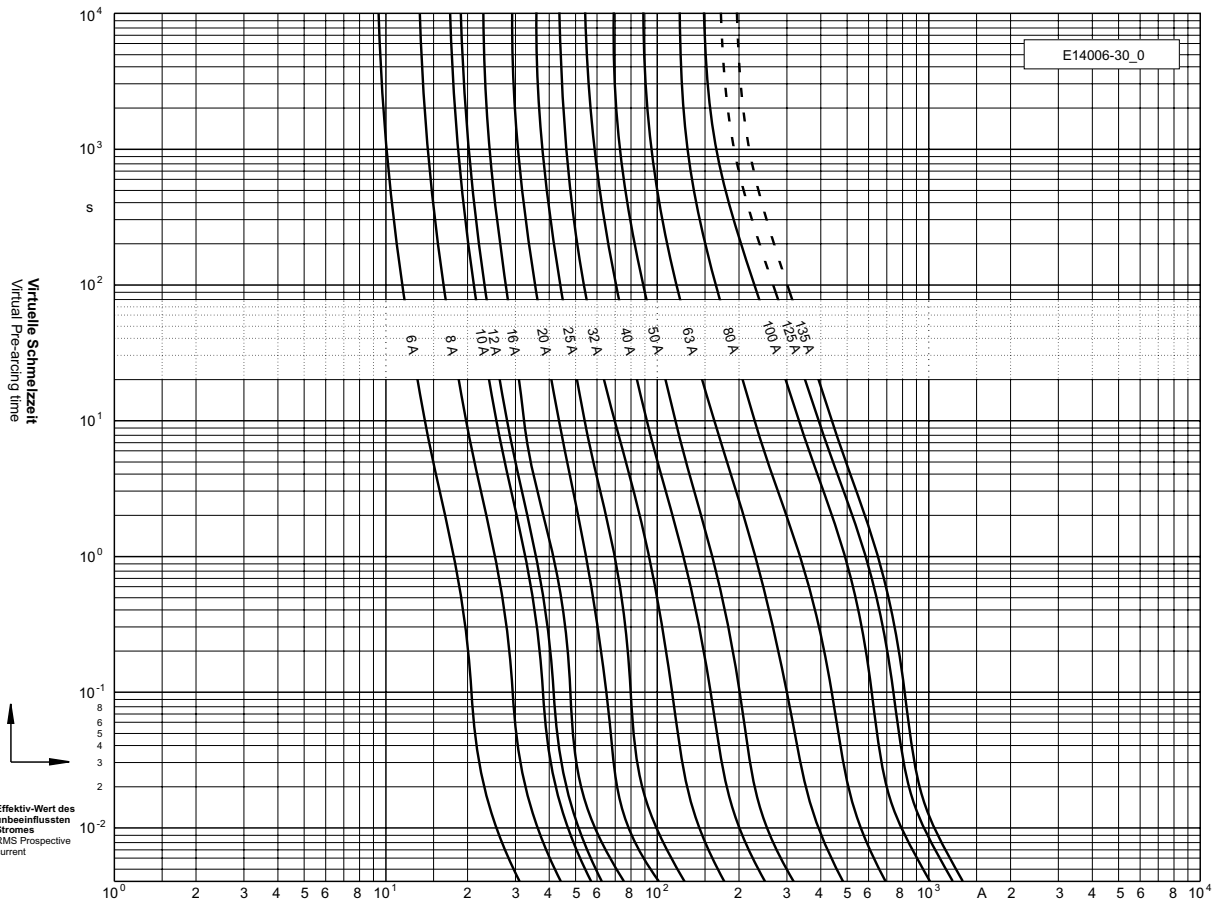

Durchlass-Strom  
Cut-off current

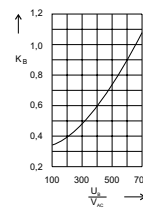
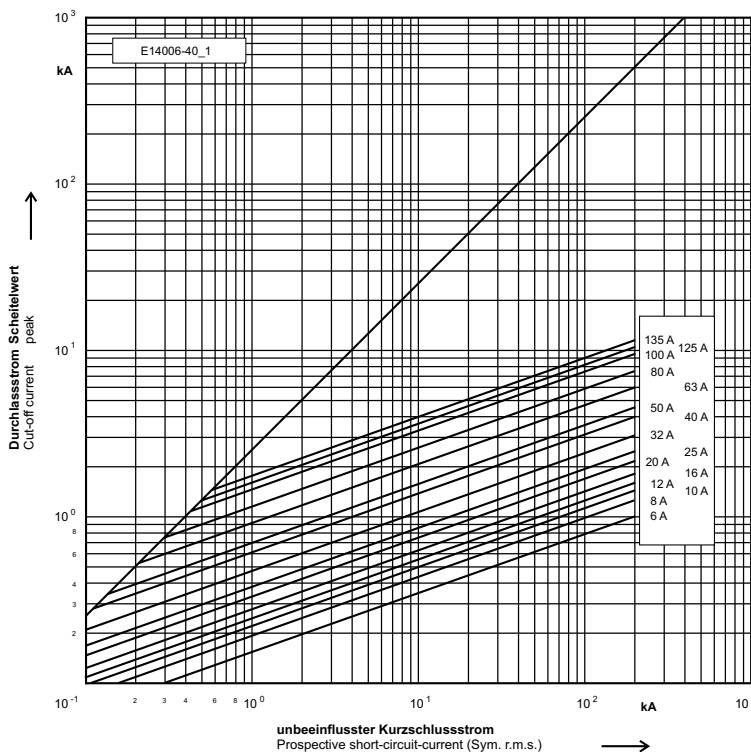

Umrechnungsfaktor  
für den  
Ausschalt  $i^2t$ -Wert  
Reduction factor  
for total  $i^2t$ -value

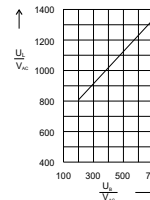

Schaltspannungs-  
diagramm  
Arc Voltage-Diagram

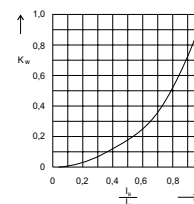

Umrechnungsfaktor  
der  
Leistungsabgabe  
Reduction factor  
for power Loss

**690 V**

**Ø 22 x 58 mm**

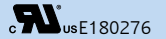

50 140 34



50 142 34

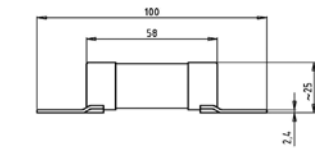

50 145 34

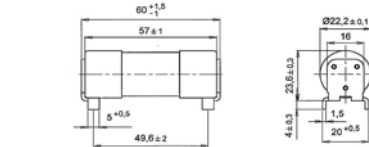

50 146 34

Verpackungseinheit / Packing unit: 10 Stück / 10 pieces

Betriebsklasse / Class <b>gRL (gS)</b>	<b>DIN EN 60269-4</b> <b>IEC 60 269-4</b> <b>VDE 0636-4</b>	<b>UL 248-13</b>
---	---	------------------

Bemessungs- spannung Rated Voltage	Artikel Nr. Article No	
V		
690 / 700 DC 440	50 140 34	ohne Auslöser without striker
	50 142 34	mit Auslöser ( min. Ansprechspg. 10V) with striker (min. operating Voltage 10V)
	50 145 34	ohne Auslöser, Stichmaß 80 mm without striker, fixing center 80 mm
	50 146 34	mit Einlötpins with soldering contacts

**Bemessungsausschaltvermögen / Rated breaking capacity 200 kA AC 700 V**  
**30 kA DC 440 V**  
**L/R = 30 mS**

Bemessungs- strom Rated Current	Artikel Nr. Article No.				Gewicht Weight	Bemessungs- spannung Rated Voltage		Schmelz- integral Pre- Arcing- I <sup>2</sup> t-Value	Ausschalt- integral Total I <sup>2</sup> t-Value @ AC 660 V	Leistungs- abgabe Power Loss
	ohne Auslöser without striker	mit Auslöser with striker	mit Schraub- kontakt with bolted connections	mit Einlötpins with soldering contacts		IEC 60269-4	UL 248-13			
	A					V	V			
25	50 140 34.25	50 142 34.25	50 145 34.25	50 146 34.25	0,06	690	700	100	800	3,6
30	50 140 34.30	50 142 34.30	50 145 34.30	50 146 34.30	0,06	690	700	190	1.500	4,6
32	50 140 34.32	50 142 34.32	50 145 34.32	50 146 34.32	0,06	690	700	250	2.000	4,8
35	50 140 34.35	50 142 34.35	50 145 34.35	50 146 34.35	0,06	690	700	370	3.000	5,0
40	50 140 34.40	50 142 34.40	50 145 34.40	50 146 34.40	0,06	690	700	420	3.400	5,2
50	50 140 34.50	50 142 34.50	50 145 34.50	50 146 34.50	0,06	690	700	870	7.000	5,4
63	50 140 34.63	50 142 34.63	50 145 34.63	50 146 34.63	0,06	690	700	1.300	10.500	6,8
80	50 140 34.80	50 142 34.80	50 145 34.80	50 146 34.80	0,06	690	700	2.500	20.000	7,5
100	50 140 34.100	50 142 34.100	50 145 34.100	50 146 34.100	0,06	690	700	4.600	37.000	9,7

Applikationskoeffizienten / Application coefficients (Weiterführende Informationen siehe Seite 13 / for more information see page 13)

a	A2	B1 max.	B2	CF3
130	1,0	1,25	0,6	0,8

690 V

Ø 22 x 58 mm

**UL** cULus E180276

**Zeit/Strom-Kennlinien**  
Time-current characteristics

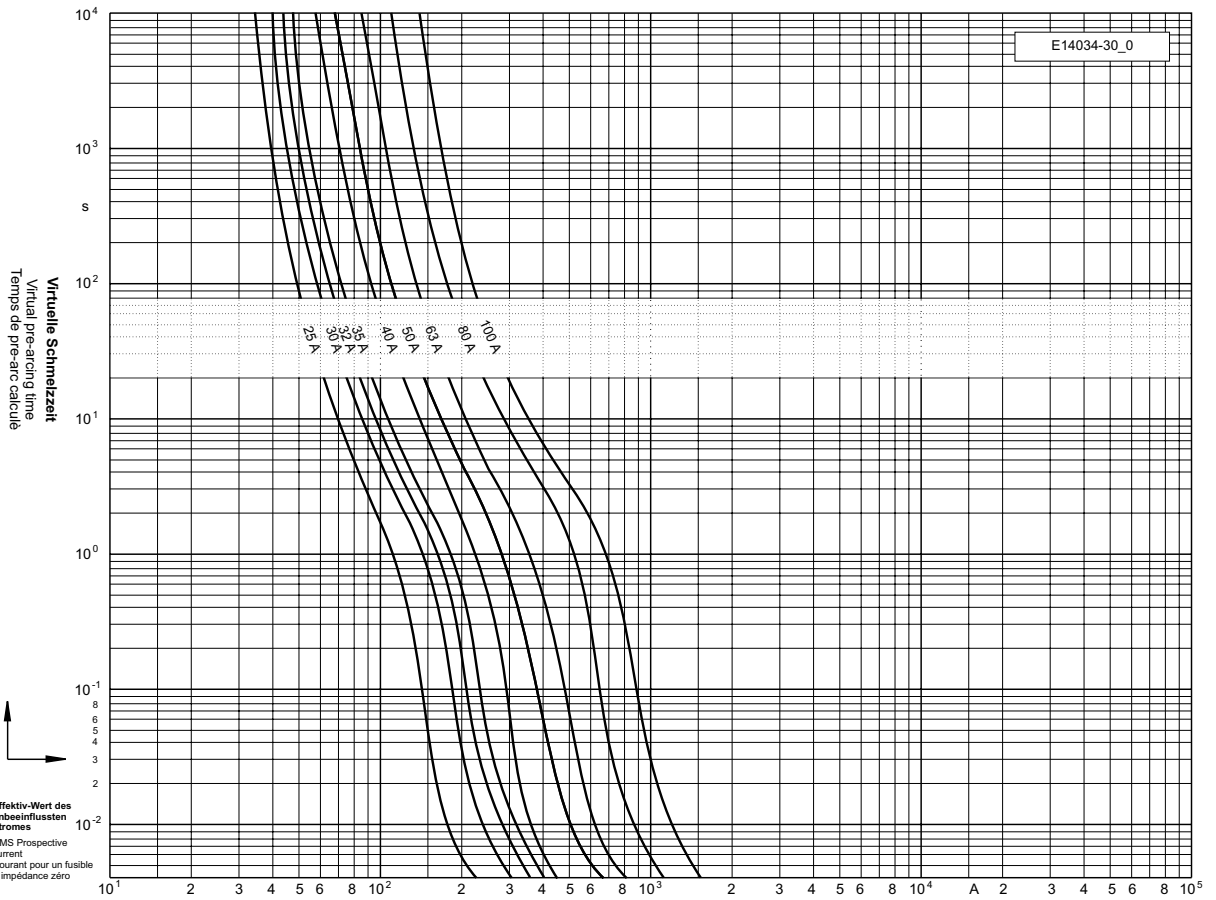

**Durchlass-Strom**  
Cut-off current

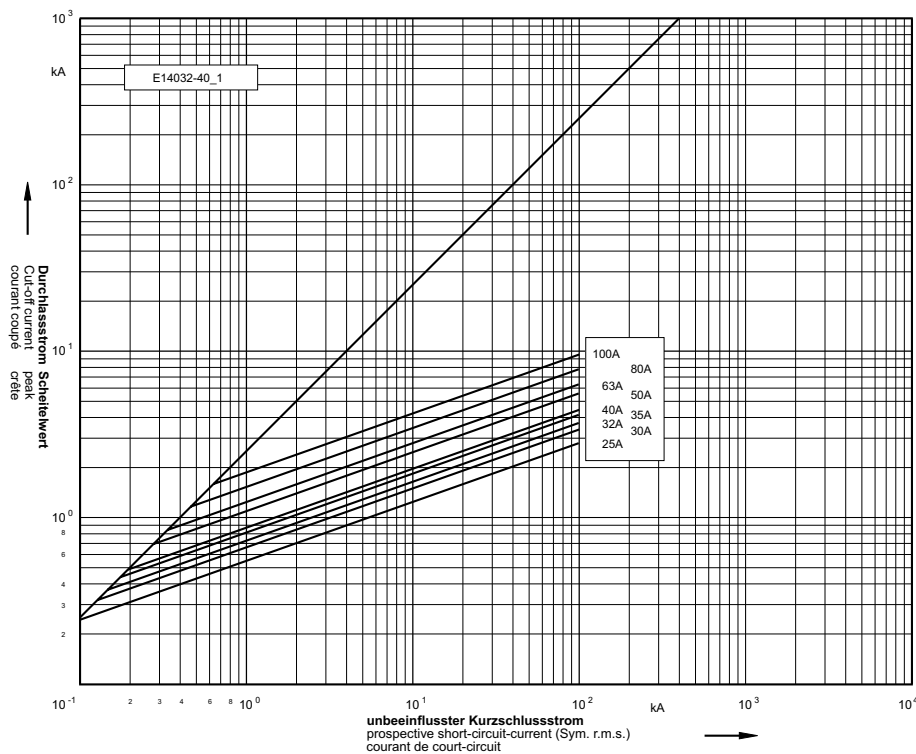

**1000 V**

**Ø 27 x 60 mm**

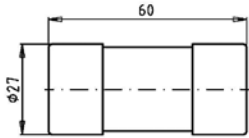

**50 196 20**

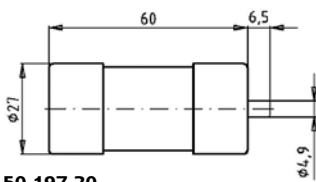

**50 197 20**

Verpackungseinheit / Packing unit: 10 Stück / 10 pieces

Betriebsklasse / Class  
**aR**

**IEC 60 269-4**  
**VDE 0636-40**

Bemessungs- spannung Rated Voltage	Artikel Nr. Article No	Größe Size	Bemessungsstrom Rated Current
V			A
1000	50 196 20	Ø 27 x 60 mm	25-170
	50 197 20		

Bemessungsausschaltvermögen / Rated breaking capacity **100 kA (AC 1000 V)**

Bemessungsstrom Rated Current	Artikel Nr. Article No.		Gewicht Weight	Bemessungs- spannung Rated Voltage	Schmelzintegral Pre-Arcing- I <sup>2</sup> t-Value	Ausschaltintegral Total I <sup>2</sup> t-Value @ AC 1000 V	Leistungsab- gabe Power Loss
	ohne Auslöser without striker	mit Auslöser with striker					
A			kg / 1	V	A <sup>2</sup> s	A <sup>2</sup> s	W
25	50 196 20.25	50 197 20.25	0,09	1000	21	135	15
32	50 196 20.32	50 197 20.32	0,09	1000	32	210	17
40	50 196 20.40	50 197 20.40	0,09	1000	82	530	17
50	50 196 20.50	50 197 20.50	0,09	1000	141	920	20
63	50 196 20.63	50 197 20.63	0,09	1000	250	1.630	22
80	50 196 20.80	50 197 20.80	0,09	1000	512	3.330	24
100	50 196 20.100	50 197 20.100	0,09	1000	1.000	6.500	26
125	50 196 20.125	50 197 20.125	0,09	1000	2.260	14.700	26
160	50 196 20.160	50 197 20.160	0,09	1000	4.600	30.000	34
170	50 196 20.170	50 197 20.170	0,09	1000	7.790	50.600	30

Applikationskoeffizienten / Application coefficients (Weiterführende Informationen siehe Seite 13 / for more information see page 13)

a	A2	B1 max.	B2	CF3
130	0,6	1,25	0,6	0,8

1000 V

Ø 27 x 60 mm

Zeit/Strom-  
Kennlinien  
Time-current  
characteristics

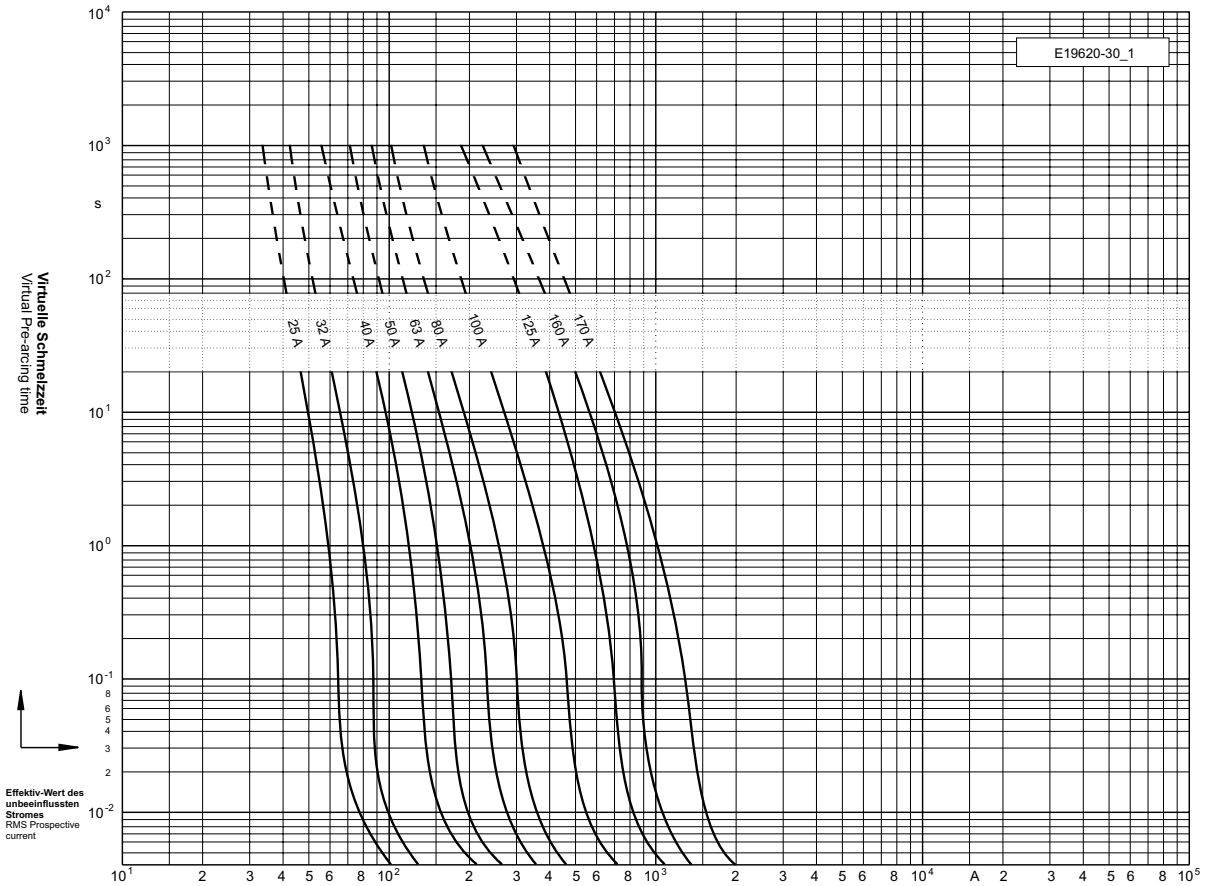

Durchlass-Strom  
Cut-off current

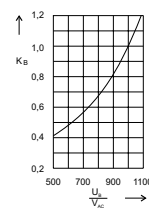
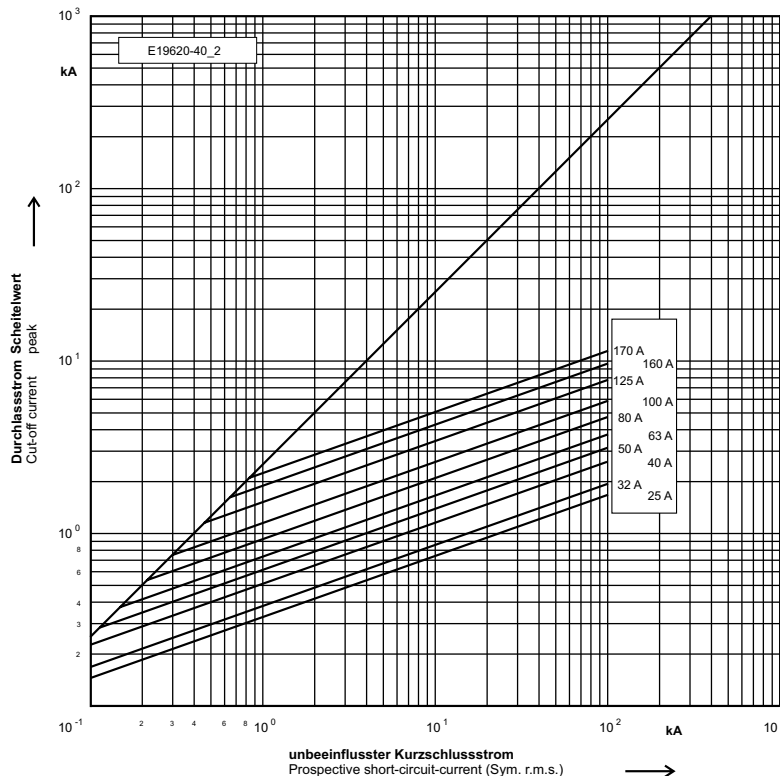

Umrechnungsfaktor  
für den  
Ausschalt  $i^2t$ -Wert  
Reduction factor  
for total  $i^2t$ -value

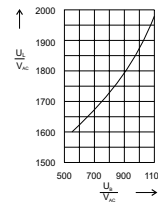

Schaltspannungs-  
diagramm  
Arc Voltage-Diagramm

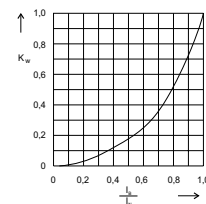

Umrechnungsfaktor  
der  
Leistungsabgabe  
Reduction factor  
for power Loss

**DC 600 V Ø 10 x 38 mm**

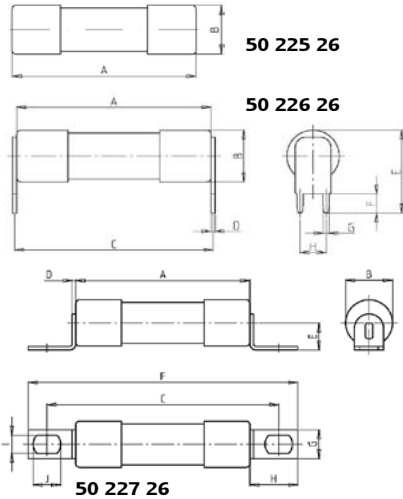
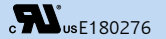

Verpackungseinheit / Packing unit: 10 Stück / 10 pieces

Betriebsklasse / Class <b>gPV / IEC</b> <b>gR / UL</b>	<b>IEC 60 269-6</b> <b>UL 248-13</b>
--	---

Bemessungs- spannung Rated Voltage	Artikel Nr. Article No	Größe Size	Länge Length									
			A	B	C	D	E	F	G	H	I	J
V			mm	mm	mm	mm	mm	mm	mm	mm	mm	mm
DC 600	50 225 26	10	38	10,3	-	-	-	-	-	-	-	-
	50 226 26	x	38	10,3	38,8	0,8	16,4	3,8	1,2	5,1	-	-
	50 227 26	38	38	10,3	50,6	0,8	6,0	58,8	6,4	10,4	4,0	6,0

Bemessungsausschaltvermögen / Rated breaking capacity **30 kA L/R = 5 ms**

Bemessungsstrom Rated Current	Artikel Nr. Article No.			Gewicht Weight	Bemessungs- spannung Rated Voltage	Schmelz- integral Pre-Arcing- I <sup>2</sup> t-Value	Leistungs- abgabe Power Loss
		mit Einlötpins for PCB mounting	mit Anschlußlaschen with bolted contacts				
A				kg / 1	V	A <sup>2</sup> s	W
1	50 225 26.1	50 226 26.1	50 227 26.1	0,01	DC 600	0,33	0,8
2	50 225 26.2	50 226 26.2	50 227 26.2	0,01	DC 600	3	1,2
3	50 225 26.3	50 226 26.3	50 227 26.3	0,01	DC 600	12	1,6
4	50 225 26.4	50 226 26.4	50 227 26.4	0,01	DC 600	10	1,8
5	50 225 26.5	50 226 26.5	50 227 26.5	0,01	DC 600	20	2,0
6	50 225 26.6	50 226 26.6	50 227 26.6	0,01	DC 600	45	2,5
8	50 225 26.8	50 226 26.8	50 227 26.8	0,01	DC 600	3	1,5
10	50 225 26.10	50 226 26.10	50 227 26.10	0,01	DC 600	5	1,8
12	50 225 26.12	50 226 26.12	50 227 26.12	0,01	DC 600	9	2,3
15	50 225 26.15	50 226 26.15	50 227 26.15	0,01	DC 600	20	2,3
16	50 225 26.16	50 226 26.16	50 227 26.16	0,01	DC 600	20	2,6
20	50 225 26.20	50 226 26.20	50 227 26.20	0,01	DC 600	29	3,1
25	50 225 26.25	50 226 26.25	50 227 26.25	0,01	DC 600	66	3,6
30	50 225 26.30	50 226 26.30	50 227 26.30	0,01	DC 600	82	5,3

Applikationskoeffizienten / Application coefficients (Weiterführende Informationen siehe Seite 13 / for more information see page 13)

a	A2	B1 max.	B2	CF3
130	0,9	1,25	0,5	0,8

**DC 600 V Ø 10 x 38 mm** cULusE180276

**Zeit/Strom-Kennlinien**  
Time-current characteristics

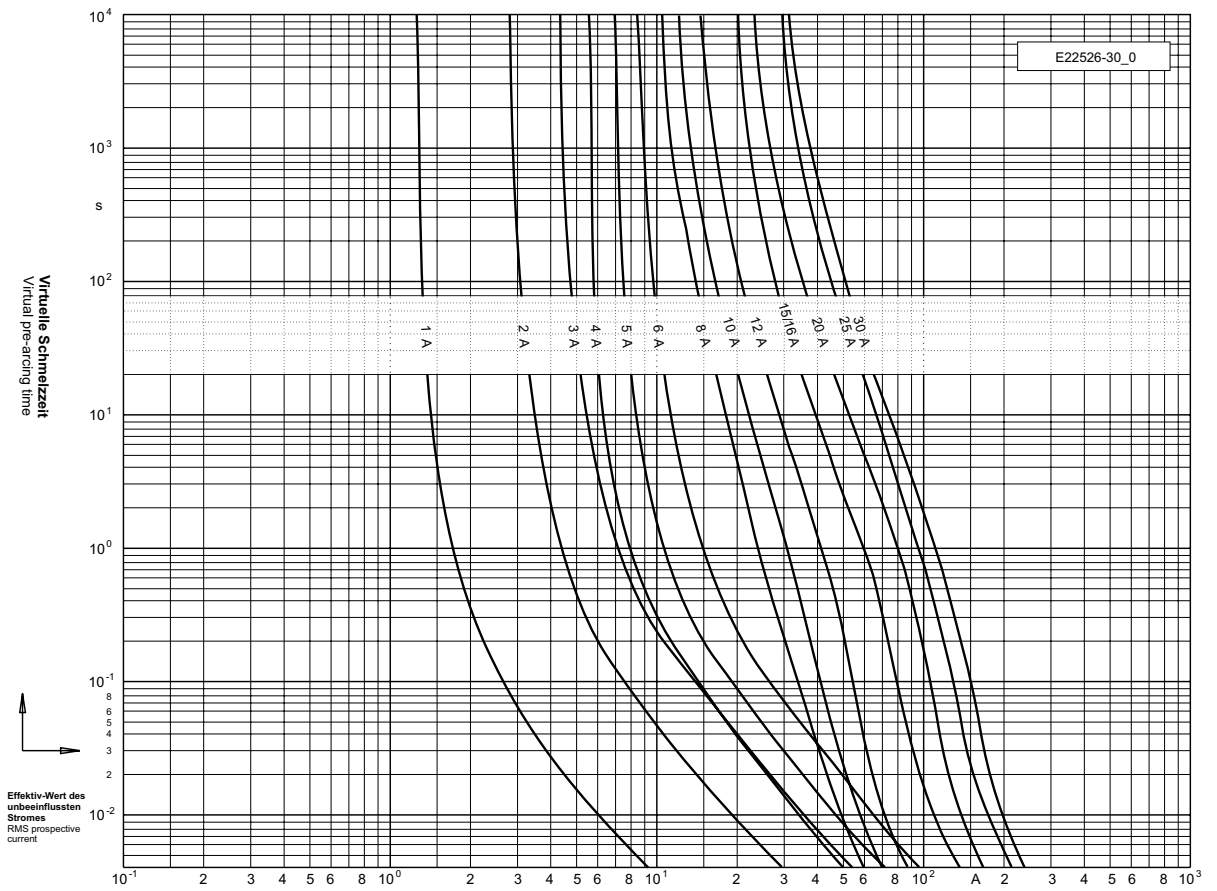

**DC 600 V Ø 16 x 137 mm**

Verpackungseinheit / Packing unit: 1 Stück / 1 pieces

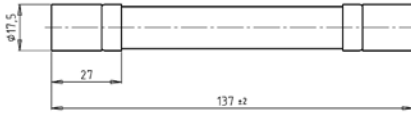

Charakteristik / Class <b>F flick</b>	
--	--

Bemessungs- spannung Rated Voltage	Artikel Nr. Article No	Größe Size	Bemessungsstrom Rated Current
V			A
DC 600	90 079 10	16 x 137 mm	4 - 35

Bemessungsausschaltvermögen / Rated breaking capacity **6 kA**

Bemessungsstrom Rated Current	Artikel Nr. Article No.	Gewicht Weight	Bemessungs- spannung Rated Voltage	Schmelzintegral Pre-Arcing- I <sup>2</sup> t-Value	Leistungsabgabe Power Loss
A		kg / 1	V	A <sup>2</sup> s	W
4	90 079 10.4	0,07	DC 600	6,9	2,3
6	90 079 10.6	0,07	DC 600	17	2,5
10	90 079 10.10	0,07	DC 600	122	3,2
16	90 079 10.16	0,07	DC 600	302	5,1
20	90 079 10.20	0,07	DC 600	490	6,4
35	90 079 10.35	0,07	DC 600	2.050	9,5

Applikationskoeffizienten / Application coefficients (Weiterführende Informationen siehe Seite 13 / for more information see page 13)

a	A2	B1 max.	B2	CF3	
130	0,8	1,25	0,8	0,8	



**DC 600 V Ø 16 x 137 mm**

**Zeit/Strom-  
Kennlinien**  
Time-current  
characteristics

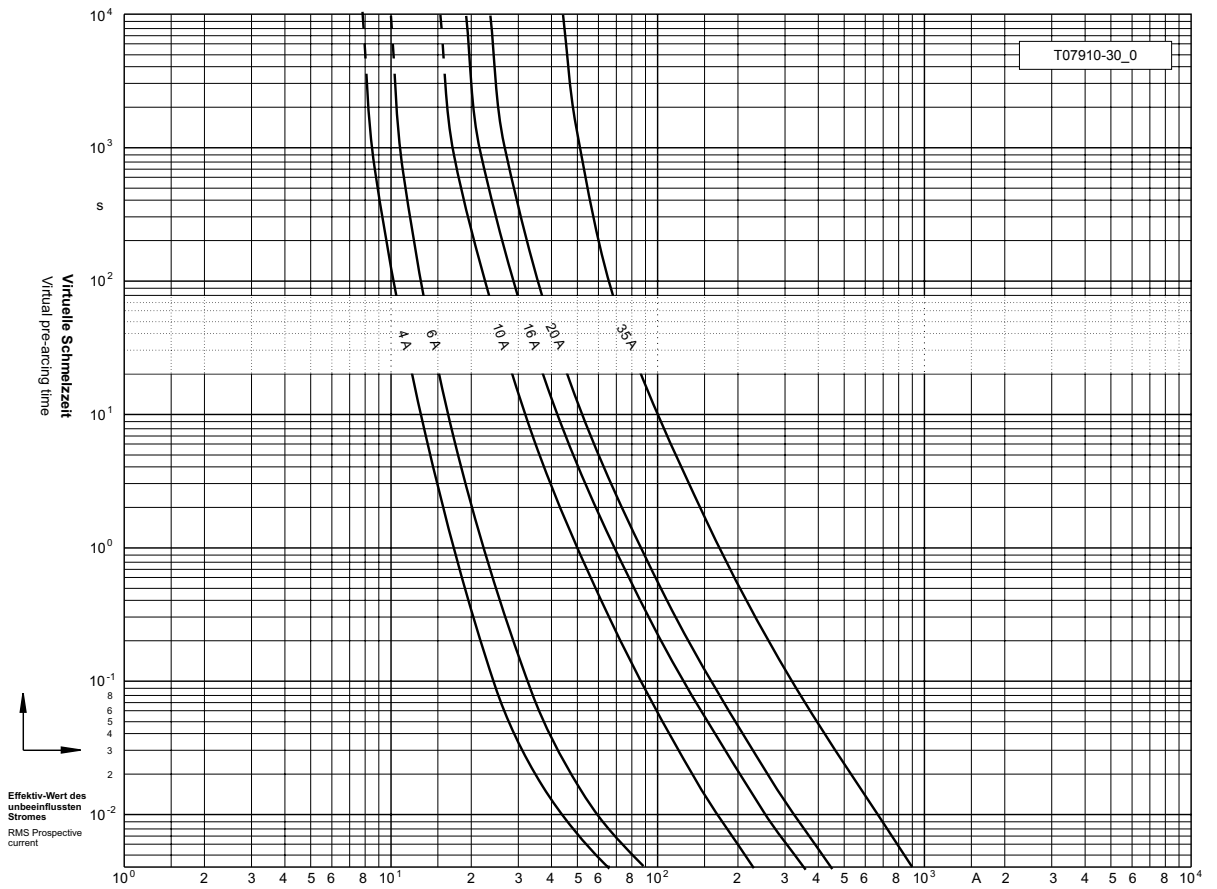

Effektiv-Wert des  
unbeeinflussten  
Stromes  
RMS Prospective  
current

**DC 660 V Ø 27 x 60 mm**

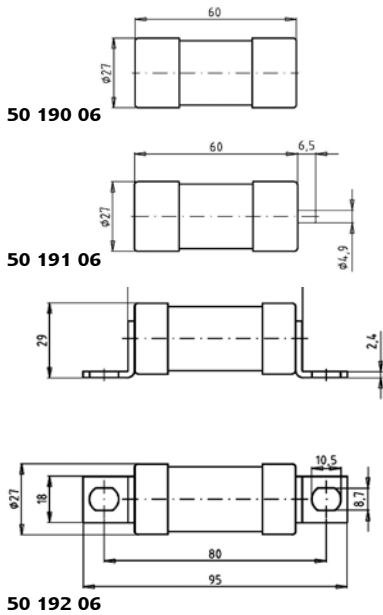
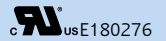

Verpackungseinheit / Packing unit: 10 Stück / 10 pieces

Betriebsklasse / Class <b>gR</b>	DIN EN 60269-4 IEC 60 269-4 VDE 0636-4	UL 248-13
-------------------------------------	--	-----------

Bemessungs- spannung Rated Voltage	Artikel Nr. Article No	Größe Size	Bemessungsstrom Rated Current
V			A
DC 660	50 190 06*	Ø 27 x 60 mm	8-160
	50 191 06		
	50 192 06*		

Bemessungsausschaltvermögen / Rated breaking capacity 30 kA L/R = 10 mS

Bemessungsstrom Rated Current	Artikel Nr. Article No.			Gewicht Weight	Bemessungs- spannung Rated Voltage		Schmelz- integral Pre-Arcing- I <sup>2</sup> t-Value	Ausschalt- integral Total I <sup>2</sup> t-Value	Leistungs- abgabe Power Loss
	ohne Auslöser without striker	mit Auslöser with striker	mit Anschlußblä- schen with bolted contacts		IEC 60269-4	UL 248-13			
	A				V	V			
8	50 190 06.8	50 191 06.8	50 192 06.8	0,10	DC 660	660	4	20	2,0
10	50 190 06.10	50 191 06.10	50 192 06.10	0,10	DC 660	660	8	40	2,2
12	50 190 06.12	50 191 06.12	50 192 06.12	0,10	DC 660	660	12	60	2,7
16	50 190 06.16	50 191 06.16	50 192 06.16	0,10	DC 660	660	32	160	3,1
20	50 190 06.20	50 191 06.20	50 192 06.20	0,10	DC 660	660	62	310	3,5
25	50 190 06.25	50 191 06.25	50 192 06.25	0,10	DC 660	660	130	650	3,9
32	50 190 06.32	50 191 06.32	50 192 06.32	0,10	DC 660	660	250	1.250	4,6
40	50 190 06.40	50 191 06.40	50 192 06.40	0,10	DC 660	660	420	2.100	6,6
50	50 190 06.50	50 191 06.50	50 192 06.50	0,10	DC 660	660	620	3.100	7,5
63	50 190 06.63	50 191 06.63	50 192 06.63	0,10	DC 660	660	1.200	6.000	8,9
80	50 190 06.80	50 191 06.80	50 192 06.80	0,10	DC 660	660	2.100	10.500	10,9
100	50 190 06.100	50 191 06.100	50 192 06.100	0,10	DC 660	660	3.500	17.500	13,5
110	50 190 06.110	50 191 06.110	50 192 06.110	0,10	DC 660	660	4.600	23.000	14,2
125	50 190 06.125	50 191 06.125	50 192 06.125	0,10	DC 440	-	7.800	29.600	16,0
160	50 190 06.160	50 191 06.160	50 192 06.160	0,10	DC 440	-	11.800	44.900	19,0

\* UL rec.

Applikationskoeffizienten / Application coefficients (Weiterführende Informationen siehe Seite 13 / for more information see page 13)

a	A2	B1 max.	B2	CF3
130	0,6	1,25	0,6	0,8

**DC 660 V Ø 27 x 60 mm**

**UL** cULus E180276

**Zeit/Strom-Kennlinien**  
Time-current characteristics

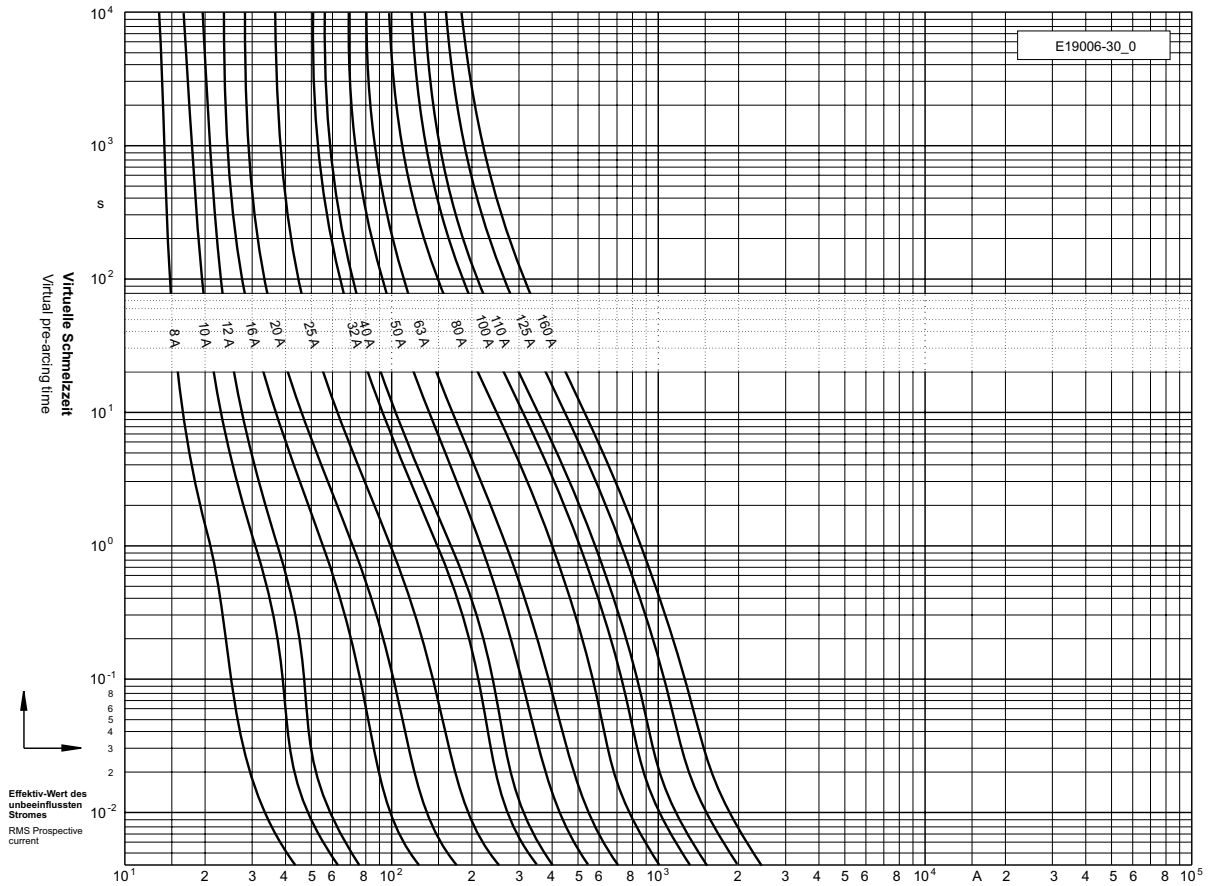

**Durchlass-Strom**  
Cut-off current

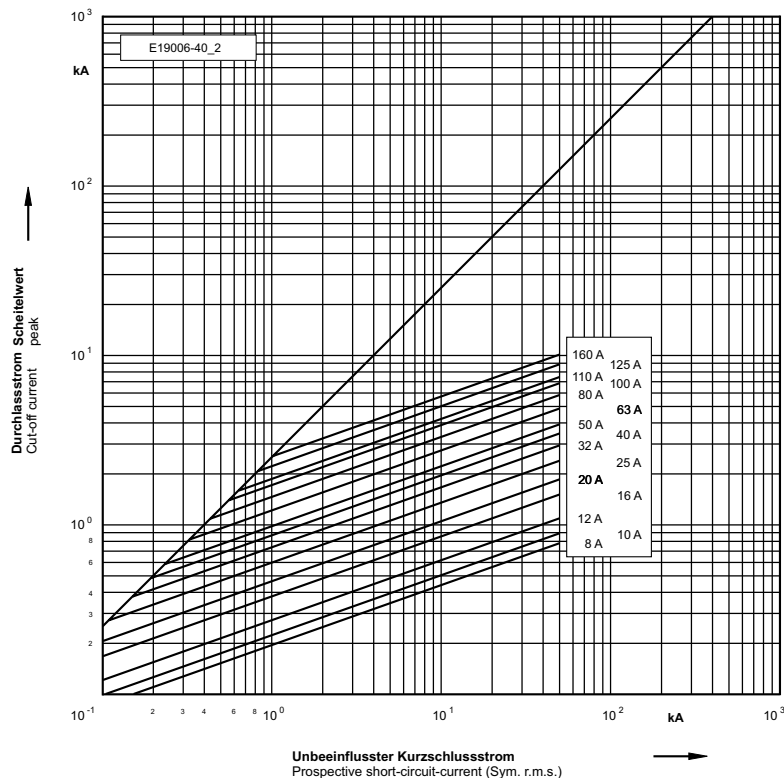

**DC 700 V** **Ø 14 x 51 mm**

 usE180276

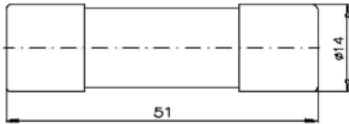

Verpackungseinheit / Packing unit: 10 Stück / 10 pieces

Betriebsklasse / Class <b>aR</b>	<b>UL 248-13</b>
-------------------------------------	------------------

Bemessungs- spannung Rated Voltage	Artikel Nr. Article No	Größe Size	Bemessungsstrom Rated Current
V			A
DC 700	50 118 06	Ø 14 x 51 mm	6-50

Bemessungsausschaltvermögen / Rated breaking capacity 50 kA (DC 700 V)

Bemessungsstrom Rated Current	Artikel Nr. Article No.	Gewicht Weight	Approbationen Approvals	Schmelzintegral Pre-Arcing I <sup>2</sup> t-Value	Ausschaltintegral Total I <sup>2</sup> t-Value @ DC 700 V	Leistungsabgabe Power Loss
A		kg / 1	UL rec.	A <sup>2</sup> s	A <sup>2</sup> s	W
6	50 118 06.6	0,02	*	2,0	12	1,3
8	50 118 06.8	0,02	*	2,9	17	1,7
10	50 118 06.10	0,02	*	3,9	25	2,6
12	50 118 06.12	0,02	*	6,5	41	3,1
16	50 118 06.16	0,02	*	8,0	52	4,7
20	50 118 06.20	0,02	*	12	70	6,0
25	50 118 06.25	0,02	*	20	130	7,6
30	50 118 06.30	0,02	*	32	190	9,8
35	50 118 06.35	0,02	-	72	430	10,3
40	50 118 06.40	0,02	-	103	620	11,2
50	50 118 06.50	0,02	-	128	770	12,6

Applikationskoeffizienten / Application coefficients (Weiterführende Informationen siehe Seite 13 / for more information see page 13)

a	A2	B1 max.	B2	Cf3
130	0,55	1,25	0,6	0,8

**DC 700 V**  $\varnothing$  14 x 51 mm

c **RU** usE180276

Zeit/Strom-  
Kennlinien  
Time-current  
characteristics

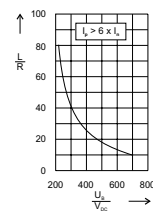
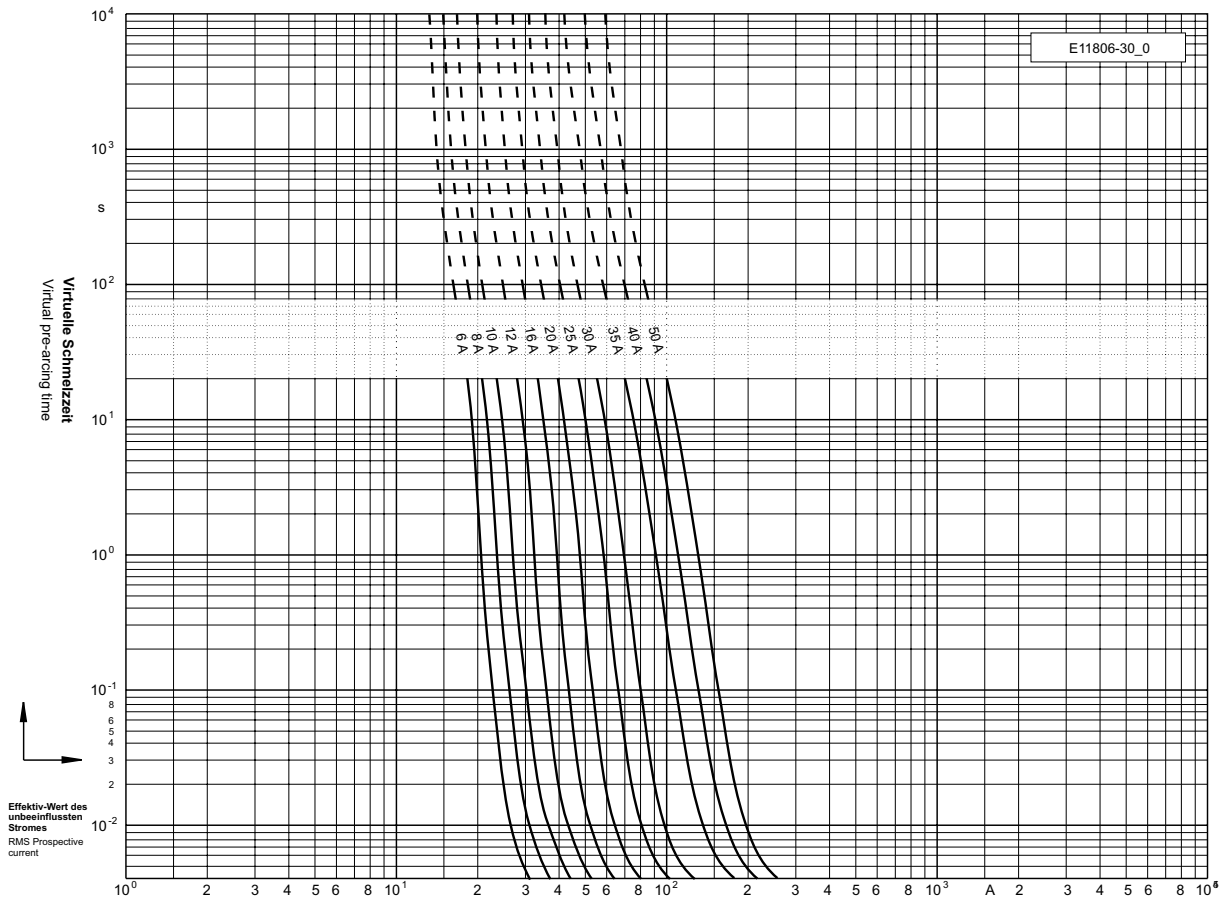

DC-Anwendung  
DC-Application

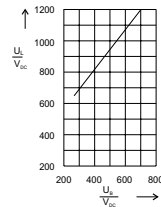

Schaltspannungs-  
diagramm  
Arc Voltage-Diagram

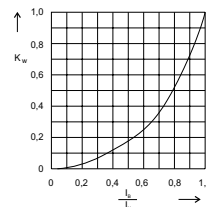

Umrechnungsfaktor  
der  
Leistungsabgabe  
Reduction factor  
for power loss

**DC 700 V**  $\varnothing$  14 x 51 mm

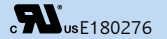

Verpackungseinheit / Packing unit: 10 Stück / 10 pieces

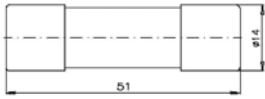

50 201 06

Betriebsklasse / Class <b>aR</b>	<b>UL 248-13</b>
-------------------------------------	------------------

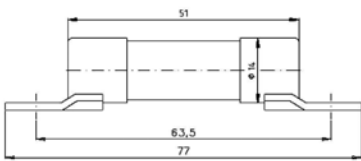

50 202 06

Bemessungs- spannung Rated Voltage	Artikel Nr. Article No	Größe Size	Bemessungsstrom Rated Current
V			A
DC 700	50 201 06	$\varnothing$ 14 x 51 mm	10-63
	50 202 06	Stichmaß 63.5 mm	

Bemessungsausschaltvermögen / Rated breaking capacity 50 kA (DC 700 V)

Bemessungsstrom Rated Current	Artikel Nr. Article No.		Gewicht Weight	Approbationen Approvals	Schmelzintegral Pre-Arcing- I <sup>2</sup> t-Value	Ausschaltintegral Total I <sup>2</sup> t-Value	Leistungs- abgabe Power Loss
A			kg / 1	UL rec.	A <sup>2</sup> s	A <sup>2</sup> s	W
10	50 201 06.10	50 202 06.10	0,02	*	12	67	1,1
12	50 201 06.12	50 202 06.12	0,02	*	20	120	1,2
16	50 201 06.16	50 202 06.16	0,02	*	32	190	2,0
20	50 201 06.20	50 202 06.20	0,02	*	63	360	2,3
25	50 201 06.25	50 202 06.25	0,02	*	82	480	3,1
32	50 201 06.32	50 202 06.32	0,02	*	130	740	4,1
40	50 201 06.40	50 202 06.40	0,02	*	250	1.460	4,6
50	50 201 06.50	50 202 06.50	0,02	*	330	1.900	7
63	50 201 06.63	50 202 06.63	0,02	*	512	3.900	9,5

Applikationskoeffizienten / Application coefficients (Weiterführende Informationen siehe Seite 13 / for more information see page 13)

a	A2	B1 max.	B2	Cf3
130	0,55	1,25	0,6	0,8

**DC 700 V**  $\varnothing 14 \times 51 \text{ mm}$

c **RU** usE180276

**Zeit/Strom-Kennlinien**  
Time-current characteristics

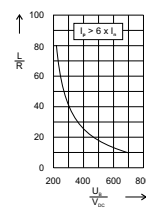
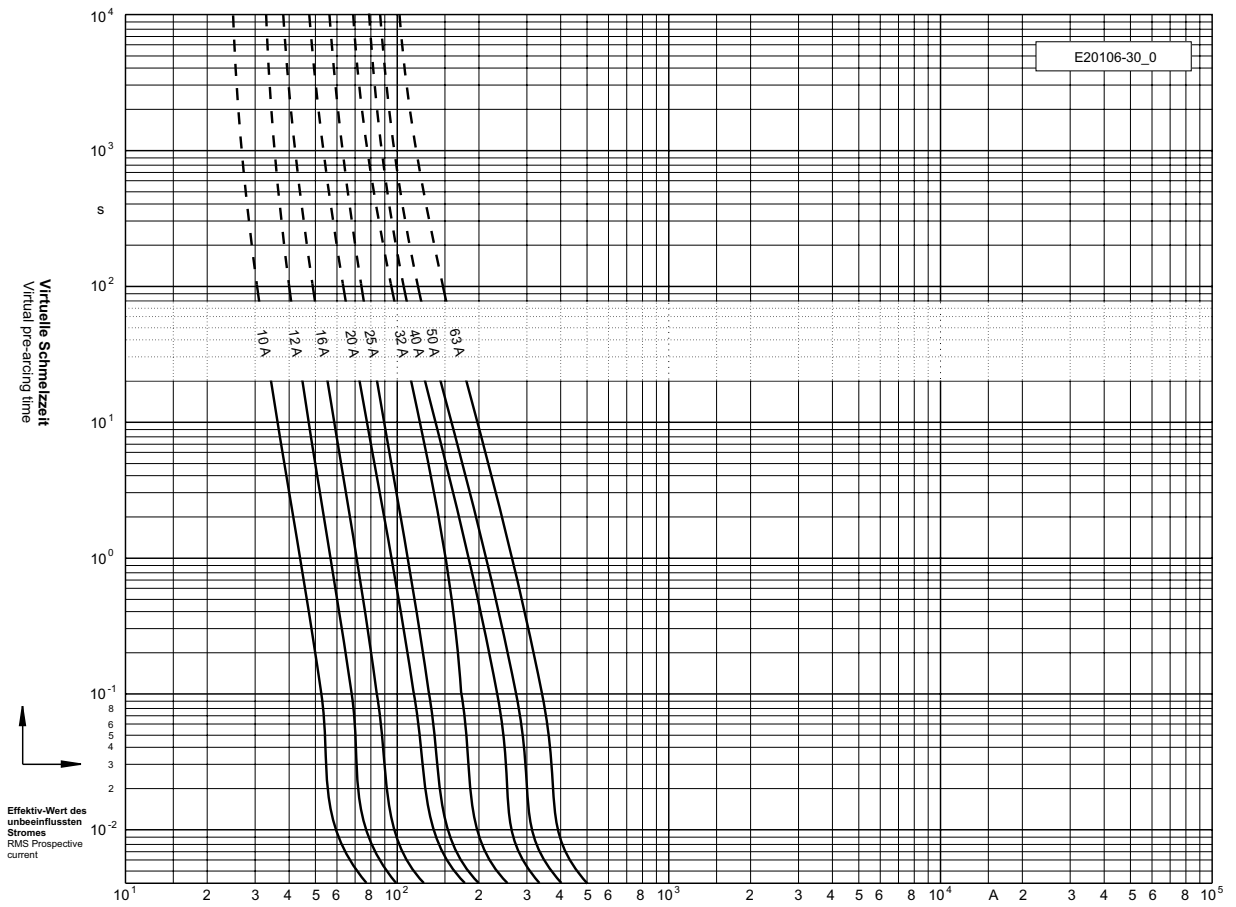

**DC-Anwendung**  
DC-Application

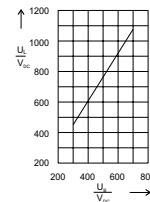

**Schaltspannungsdiagramm**  
Arc Voltage-Diagram

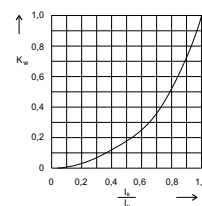

**Umrechnungsfaktor der Leistungsabgabe**  
Reduction factor for power Loss

**DC 800 V Ø 14 x 51 mm**

 usE180276

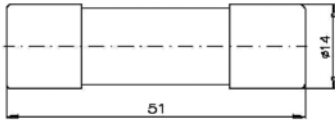

Verpackungseinheit / Packing unit: 10 Stück / 10 pieces

Betriebsklasse / Class <b>gR</b>	<b>UL 248-13</b>
-------------------------------------	------------------

Bemessungs- spannung Rated Voltage	Artikel Nr. Article No	Größe Size	Bemessungsstrom Rated Current
V			A
DC 800	50 120 06	Ø 14 x 51 mm	20-32

Bemessungsausschaltvermögen / Rated breaking capacity 10 kA (DC 800 V)

Bemessungsstrom Rated Current	Artikel Nr. Article No.	Gewicht Weight	Approbationen Approvals	Schmelzintegral Pre-Arcing I <sup>2</sup> t-Value	Ausschaltintegral Total I <sup>2</sup> t-Value @ DC 880 V	Leistungsabgabe Power Loss
A		kg / 1	UL rec.	A <sup>2</sup> s	A <sup>2</sup> s	W
20	50 120 06.20	0,02	*	46	370	3,2
25	50 120 06.25	0,02	*	90	715	4,0
32	50 120 06.32	0,02	*	120	950	5,5

Applikationskoeffizienten / Application coefficients (Weiterführende Informationen siehe Seite 13 / for more information see page 13)

a	A2	B1 max.	B2	Cf3
130	0,8	1,25	0,6	0,8



**DC 800 V Ø 14 x 51 mm**

**UL** cULusE180276

**Zeit/Strom-  
Kennlinien**  
Time-current  
characteristics

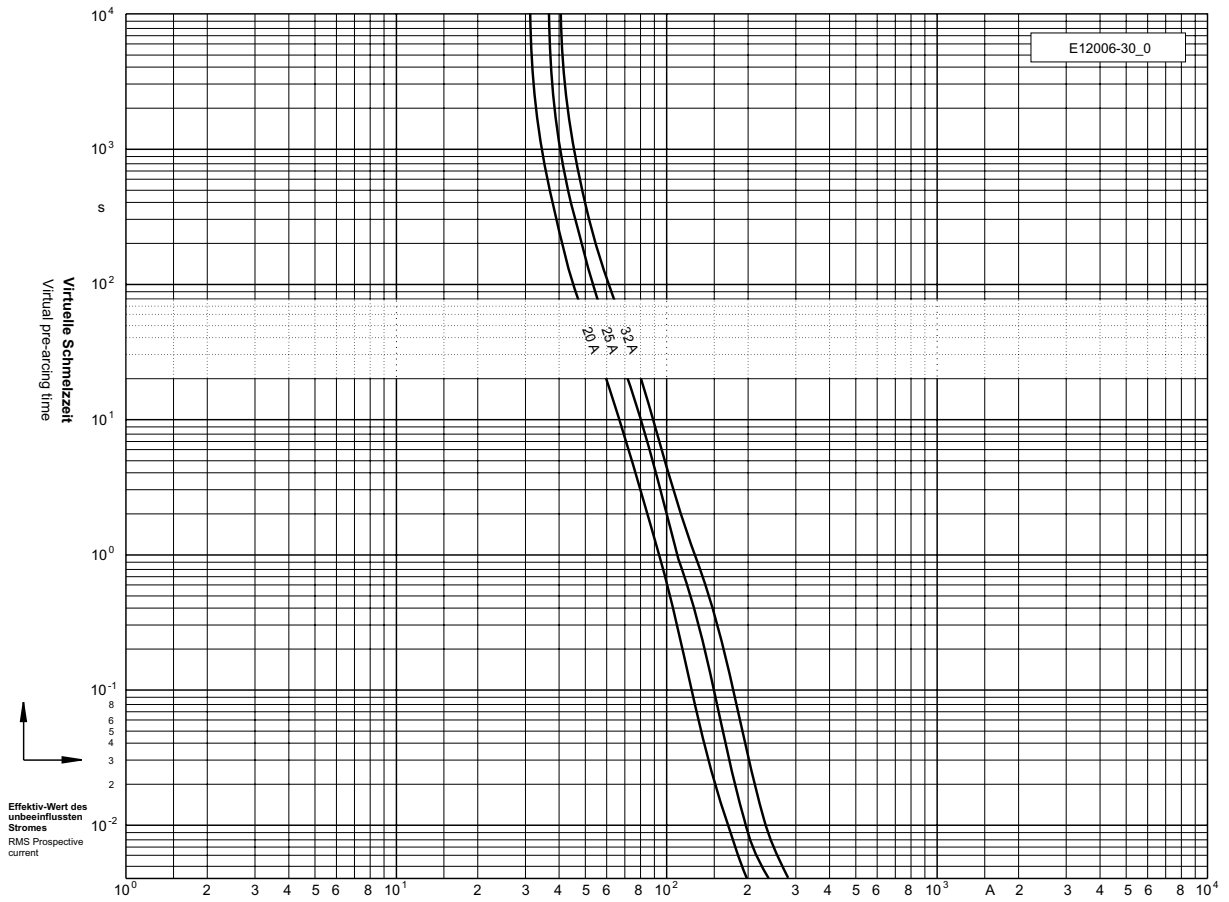

**DC 1000 V Ø 10 x 38 mm**

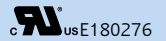

Verpackungseinheit / Packing unit: 10 Stück / 10 pieces

Betriebsklasse / Class <b>gR</b>	IEC 60269-4 UL 248-13
-------------------------------------	--------------------------

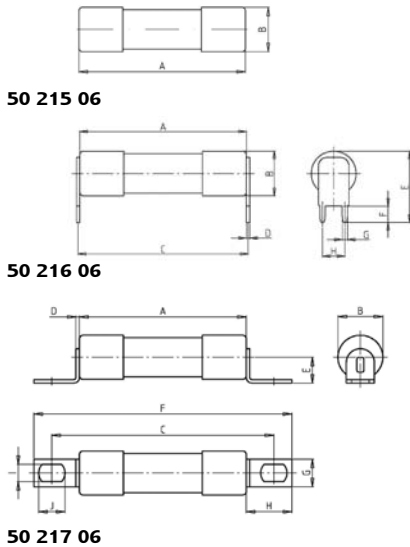

Bemessungs- spannung Rated Voltage	Artikel Article	Größe Size	Länge Length									
			A	B	C	D	E	F	G	H	I	J
V			mm	mm	mm	mm	mm	mm	mm	mm	mm	mm
DC 900	50 215 06	10	38	10,3	-	-	-	-	-	-	-	-
	50 216 06	x	38	10,3	38,8	0,8	16,4	3,8	1,2	5,1	-	-
	50 217 06	38	38	10,3	50,6	0,8	6,0	58,8	6,4	10,4	4,0	6,0

Bemessungsausschaltvermögen / Rated breaking capacity 30 kA L/R = 1 ms

Bemessungs- strom Rated Current	Artikel Nr. Article No.			Gewicht Weight	Bemessungs- spannung Rated Voltage	Schmelz- integral Pre- Arcing- I <sup>2</sup> t-Value	Ausschalt- integral Total I <sup>2</sup> t-Value @ DC 1000 V	Leistungs- abgabe * Power Loss
		mit Einlötpins for panel mounting	mit Anschraub- laschen with bolt contacts					
	A							
0,5	50 215 06.0,5	50 216 06.0,5	50 217 06.0,5	0,01	900	0,2	2,2	0,2
1	50 215 06.1	50 216 06.1	50 217 06.1	0,01	900	0,45	2	0,3
2	50 215 06.2	50 216 06.2	50 217 06.2	0,01	900	1,2	3	0,4
3,5	50 215 06.3,5	50 216 06.3,5	50 217 06.3,5	0,01	900	5	27	0,5
6	50 215 06.6	50 216 06.6	50 217 06.6	0,01	900	5	40	0,7
8	50 215 06.8	50 216 06.8	50 217 06.8	0,01	900	7	55	1,1
10	50 215 06.10	50 216 06.10	50 217 06.10	0,01	900	10	77	1,5
12	50 215 06.12	50 216 06.12	50 217 06.12	0,01	900	20	155	1,6
15	50 215 06.15	50 216 06.15	50 217 06.15	0,01	900	30	230	1,9
16	50 215 06.16	50 216 06.16	50 217 06.16	0,01	900	30	230	2,1
20	50 215 06.20	50 216 06.20	50 217 06.20	0,01	900	52	395	2,5

Applikationskoeffizienten / Application coefficients (Weiterführende Informationen siehe Seite 13 / for more information see page 13)

a	A2	B1 max.	B2	CF3
130	0,9	1,25	0,5	0,8

**DC 1000 V Ø 10 x 38 mm**

**UL** cULusE180276

**Zeit/Strom-  
Kennlinien**  
Time-current  
characteristics

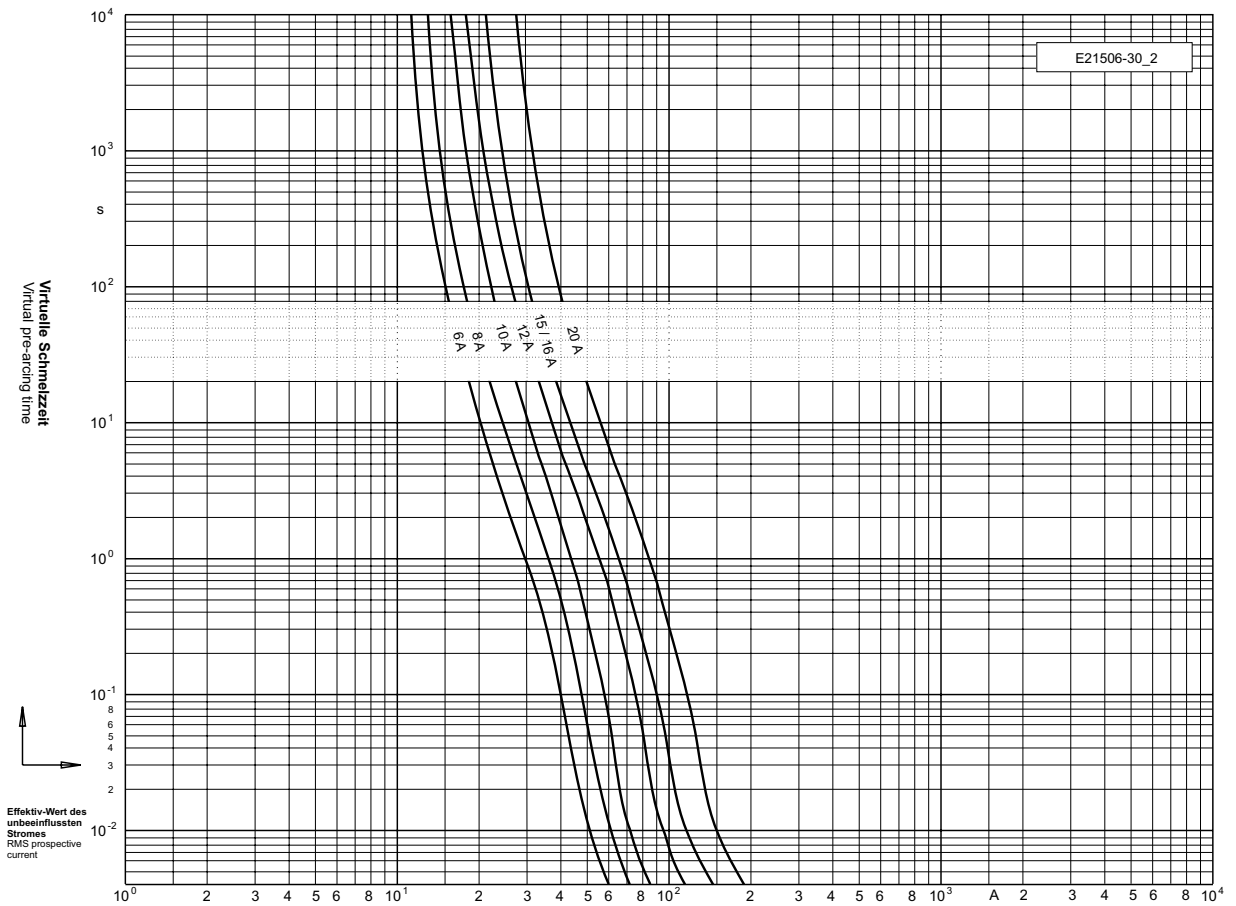

AC/DC 1000 V Ø 6,3 x 32 mm

 usE167295

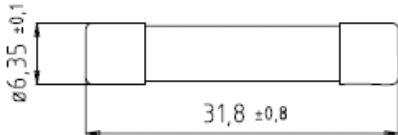

Verpackungseinheit / Packing unit: 10 Stück / 10 pieces

Charakteristik / Class <b>FF</b>	Werksnorm company standard
-------------------------------------	-------------------------------

Bemessungs- spannung Rated Voltage	Artikel Nr. Article No	Größe Size	Bemessungsstrom Rated Current
V			A
AC/DC 1000	70 172 40	6,3 x 32	0,100-2

Bemessungsausschaltvermögen / Rated breaking capacity 30 kA

Bemessungsstrom Rated Current	Artikel Nr. Article No.	Gewicht Weight	Be- messungs- spannung Rated Voltage	Spannungs- abfall Max. Voltage drop	Schmelz- integral Pre-Arcing- I <sup>2</sup> t-Value @ 10 x I <sub>N</sub>	Bemessungs-Ausschaltvermögen Rated breaking capacity		Leistungs- abgabe Power Loss
						AC	DC	
A		kg / 1	V	mV	A <sup>2</sup> s			W
0,100	70 172 40.0,1	0,002	AC/DC 1000	2.500	0.0009	30 kA @ 1000 V*	30 kA @ 1000 V*	0,3
0,125	70 172 40.0,125	0,002	AC/DC 1000	2.200	0.0017	30 kA @ 1000 V*	30 kA @ 1000 V*	0,3
0,160	70 172 40.0,16	0,002	AC/DC 1000	2.000	0.004	30 kA @ 1000 V*	30 kA @ 1000 V*	0,4
0,200	70 172 40.0,2	0,002	AC/DC 1000	900	0.01	30 kA @ 1000 V*	30 kA @ 1000 V*	0,2
0,250	70 172 40.0,25	0,002	AC/DC 1000	800	0.02	30 kA @ 1000 V*	30 kA @ 1000 V*	0,2
0,315	70 172 40.0,315	0,002	AC/DC 1000	700	0.04	30 kA @ 1000 V*	30 kA @ 1000 V*	0,3
0,400	70 172 40.0,4	0,002	AC/DC 1000	650	0.07	30 kA @ 1000 V*	30 kA @ 1000 V*	0,3
0,500	70 172 40.0,5	0,002	AC/DC 1000	650	0.12	30 kA @ 1000 V*	30 kA @ 1000 V*	0,4
0,630	70 172 40.0,63	0,002	AC/DC 1000	650	0.15	30 kA @ 1000 V	30 kA @ 1000 V	0,5
0,800	70 172 40.0,8	0,002	AC/DC 1000	600	0.23	30 kA @ 1000 V	30 kA @ 1000 V	0,5
1	70 172 40.1	0,002	AC/DC 1000	750	0.32	30 kA @ 1000 V	30 kA @ 1000 V	0,8
1,6	70 172 40.1,6	0,002	AC/DC 1000	650	0.31	30 kA @ 1000 V	30 kA @ 1000 V	1,1
2	70 172 40.2	0,002	AC/DC 1000	650	0.64		30 kA @ 1000 V	1,4

\* Zusätzlicher Bemessungs-Ausschaltvermögen: 50 kA @ 1000 V AC/DC  
Additional rated breaking capacity: 50 kA @ 1000 V AC/DC

Applikationskoeffizienten / Application coefficients (Weiterführende Informationen siehe Seite 13 / for more information see page 13)

a	A2	B1 max.	B2	Cf3
130	0,8	1,25	0,8	0,8

**AC/DC 1000 V Ø 6,3 x 32 mm**

**RU**  
usE167295

**Zeit/Strom-  
Kennlinien**  
Time-current  
characteristics

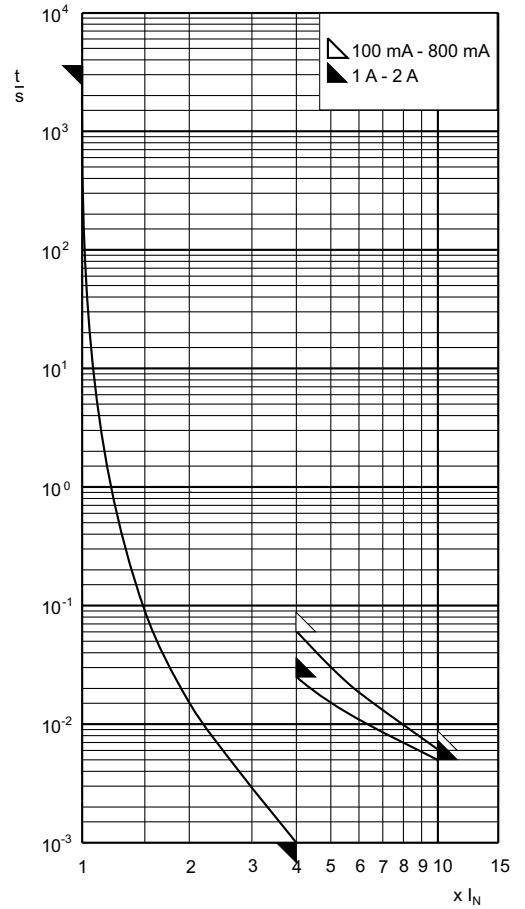

**AC/DC 1000 V Ø 10 x 35 mm**

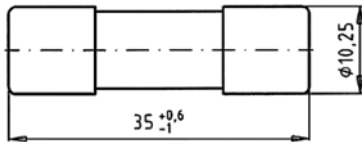

Verpackungseinheit / Packing unit: 10 Stück / 10 pieces

Betriebsklasse / Class <b>aR</b>	Werksnorm company standard
-------------------------------------	-------------------------------

Bemessungs- spannung Rated Voltage	Artikel Nr. Article No	Größe Size	Bemessungsstrom Rated Current
V			mA
AC/DC 1000	50 210 06	Ø 10 x 35 mm	200-440

Bemessungsausschaltvermögen / Rated breaking capacity **30 kA**

Bemessungsstrom Rated Current	Artikel Nr. Article No.	Gewicht Weight	Bemessungs- spannung Rated Voltage	Schmelz- integral Pre-Arcing- I <sup>2</sup> t-Value	Ausschalt- integral Total I <sup>2</sup> t-Value @AC 1000 V	Ausschalt- integral Total I <sup>2</sup> t-Value @DC 1000 V	Leistungs- abgabe Power Loss @ 10 x I <sub>rat</sub>	Widerstand bei 20°C Resistant @20°C
mA		kg / 1	V	A <sup>2</sup> s	A <sup>2</sup> s	A <sup>2</sup> s	W	mΩ
200	50 210 06.0,2	0,01	1000	0,02	0,15	0,12	0,12	2720
250	50 210 06.0,25	0,01	1000	0,04	0,28	0,2	0,13	2000
315	50 210 06.0,315	0,01	1000	0,07	0,5	0,4	0,16	1530
400	50 210 06.0,4	0,01	1000	0,11	0,8	0,7	0,2	1200
440	50 210 06.0,44	0,01	1000	0,17	1,2	1	0,2	980

Applikationskoeffizienten / Application coefficients (Weiterführende Informationen siehe Seite 13 / for more information see page 13)

a	A2	B1 max.	B2	CF3
150	0,6	1,25	0,6	0,8

**AC/DC 1000 V Ø 10 x 35 mm**

**Zeit/Strom-  
Kennlinien**  
Time-current  
characteristics

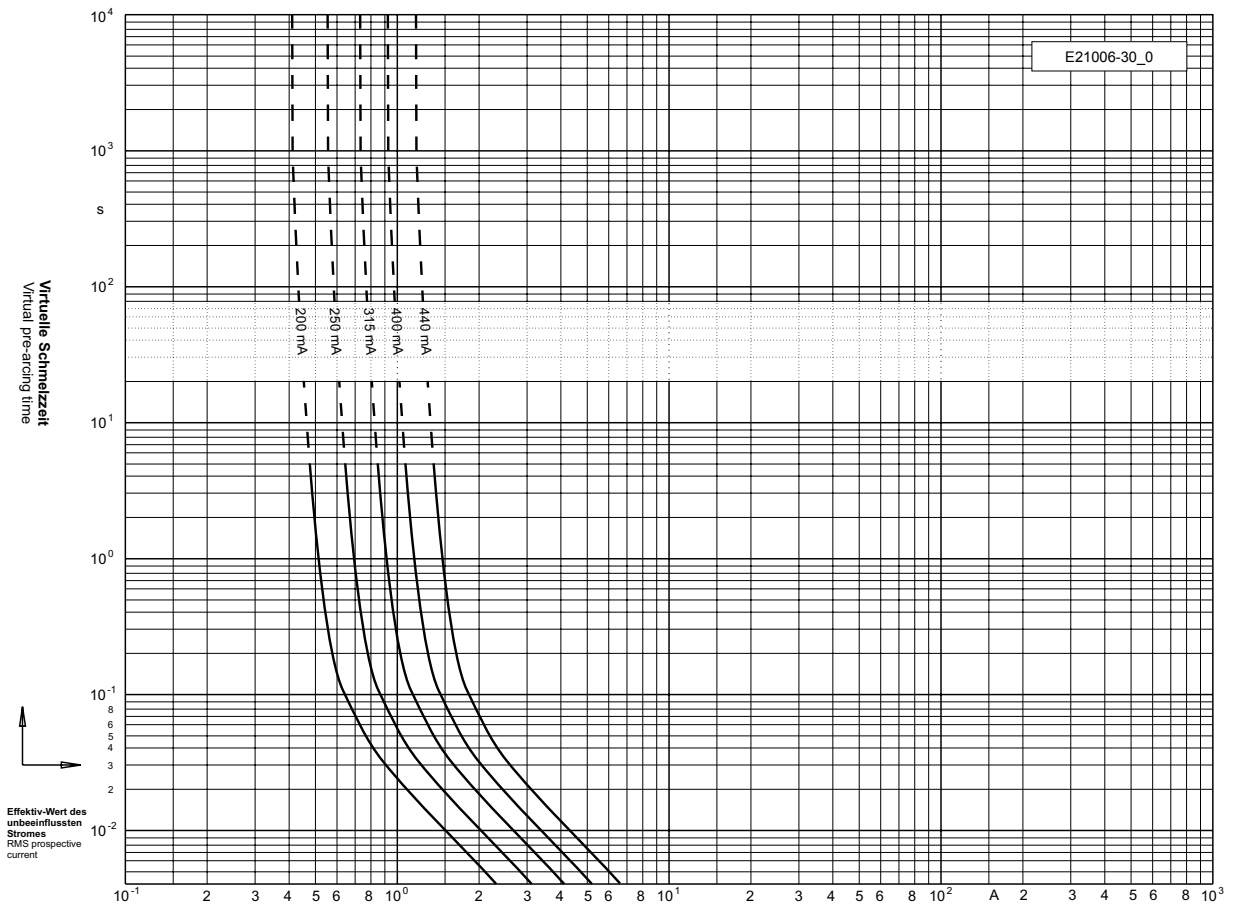

**AC/DC 1000 V Ø 10 x 38 mm**

 **usE180276**

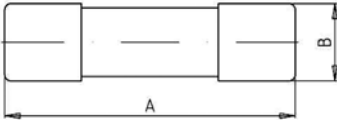

**Verpackungseinheit / Packing unit:** 10 Stück / 10 pieces

Betriebsklasse / Class <b>gR</b>	<b>UL 248-13</b>
-------------------------------------	------------------

Bemessungs- spannung Rated Voltage	Artikel Nr. Article No	Größe Size	Bemessungsstrom Rated Current
V			A
AC/DC 1000	50 199 06	Ø 10 x 38 mm	0,5-16

**Bemessungsausschaltvermögen / Rated breaking capacity** 30 kA L/R = 1 ms

Bemessungsstrom Rated Current	Artikel Nr. Article No.	Gewicht Weight	Bemessungs- spannung Rated Voltage	Bemessungs- ausschalt- vermögen Rated breaking capacity @AC/DC 1000 V	Schmelzintegral Pre-Arcing- I <sup>2</sup> t-Value	Ausschaltintegral Total I <sup>2</sup> t-Value @ DC 1000 V L/R=5ms	Leistungsabgabe Power Loss
A		kg / 1	V	kA	A <sup>2</sup> s	A <sup>2</sup> s	W
0,5	50 199 06.0,5	0,01	1000	30	0,2	2,2	0,2
1	50 199 06.1	0,01	1000	30	0,45	2	0,3
2	50 199 06.2	0,01	1000	30	1,2	3	0,9
3,5	50 199 06.3,5	0,01	1000	30	5	27	1,8
4	50 199 06.4	0,01	1000	30	3	25	0,5
6	50 199 06.6	0,01	1000	30	5	40	0,7
8	50 199 06.8	0,01	1000	30	7	55	1,1
10	50 199 06.10	0,01	1000	30	10	77	1,5
11	50 199 06.11	0,01	1000	30	17	130	1,6
12	50 199 06.12	0,01	1000	30	20	155	1,6
15	50 199 06.15	0,01	1000	30	30	230	1,8
16	50 199 06.16	0,01	1000	30	30	230	2,1

Applikationskoeffizienten / Application coefficients (Weiterführende Informationen siehe Seite 13 / for more information see page 13)

a	A2	B1 max.	B2	CF3
150	0,6	1,25	0,5	0,8



AC/DC 1000 V Ø 10 x 38 mm

cULus E180276

Zeit/Strom-  
Kennlinien  
Time-current  
characteristics

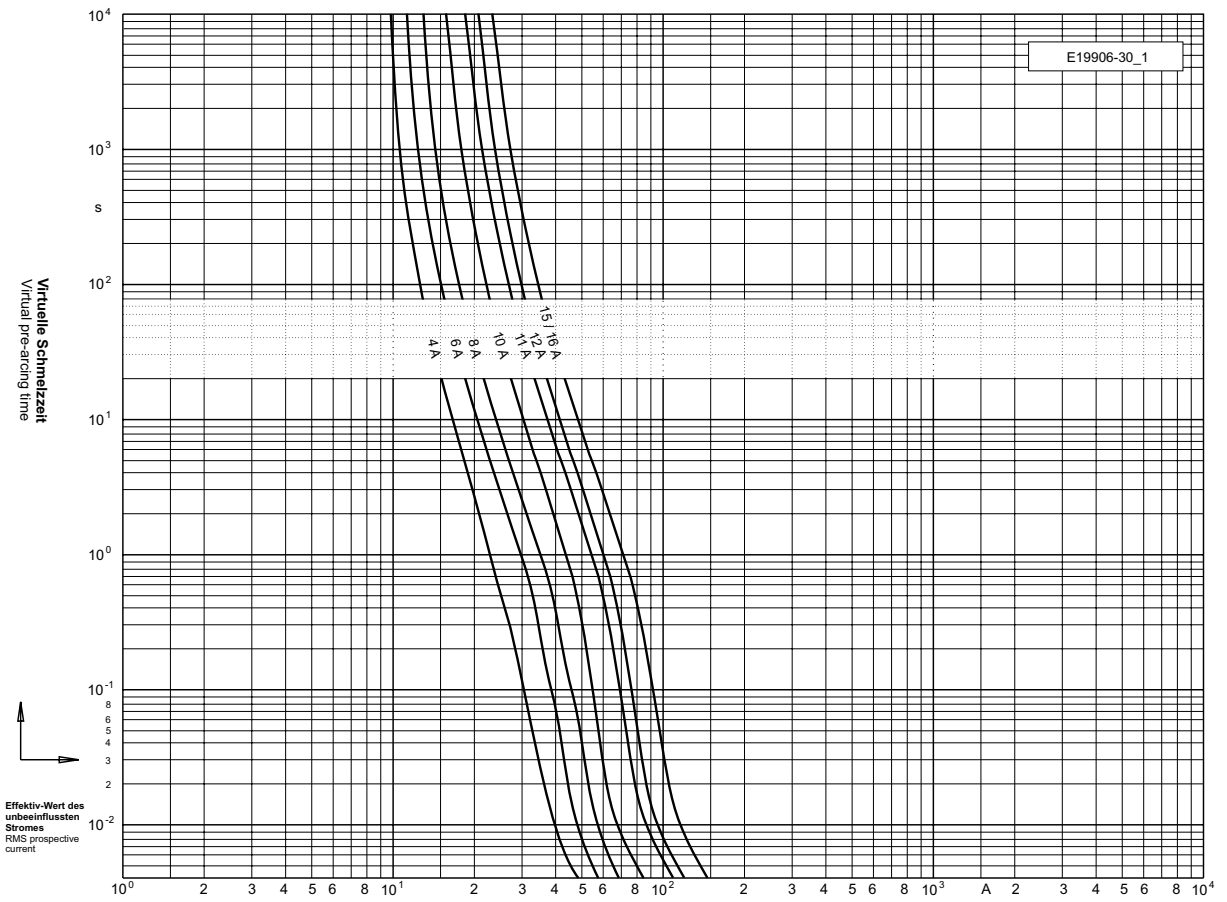

**DC 1000 V Ø 14 x 51 mm**

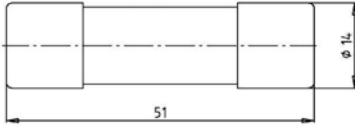

50 204 26

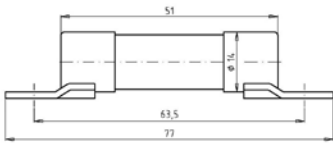

50 205 26



Verpackungseinheit / Packing unit: 10 Stück / 10 pieces

Betriebsklasse / Class <b>gPV</b>	<b>IEC 60269-6</b>
--------------------------------------	--------------------

Bemessungs- spannung Rated Voltage	Artikel Nr. Article No	Größe Size	Bemessungsstrom Rated Current
V			A
DC 1000	50 204 26	Ø 14 x 51 mm	10-32
	50 205 26		

Bemessungsausschaltvermögen / Rated breaking capacity **30 kA L/R = 1-3 ms**

Bemessungs- strom Rated Current	Artikel Nr. Article No.		Gewicht Weight	Bemessungs- spannung Rated Voltage	Schmelz- integral Pre-Arcing- I <sup>2</sup> t-Value	Ausschalt- integral Total I <sup>2</sup> t-Value @ breaking test Voltage	Leistungs- abgabe Power Loss
A			kg / 1	V	A <sup>2</sup> s	A <sup>2</sup> s	W
10	50 204 26.10	50 205 26.10	0,02	1000	5	40	2,9
12	50 204 26.12	50 205 26.12	0,02	1000	12	100	3,0
20	50 204 26.20	50 205 26.20	0,02	1000	52	330	4,0
25	50 204 26.25	50 205 26.25	0,02	1000	82	510	5,1
32	50 204 26.32	50 205 26.32	0,02	1000	150	950	6,0

Applikationskoeffizienten / Application coefficients (Weiterführende Informationen siehe Seite 13 / for more information see page 13)

a	A2	B1 max.	B2	CF3
130	0,9	1,25	0,5	0,8

**DC 1000 V Ø 14 x 51 mm**

**Zeit/Strom-  
Kennlinien**  
Time-current  
characteristics

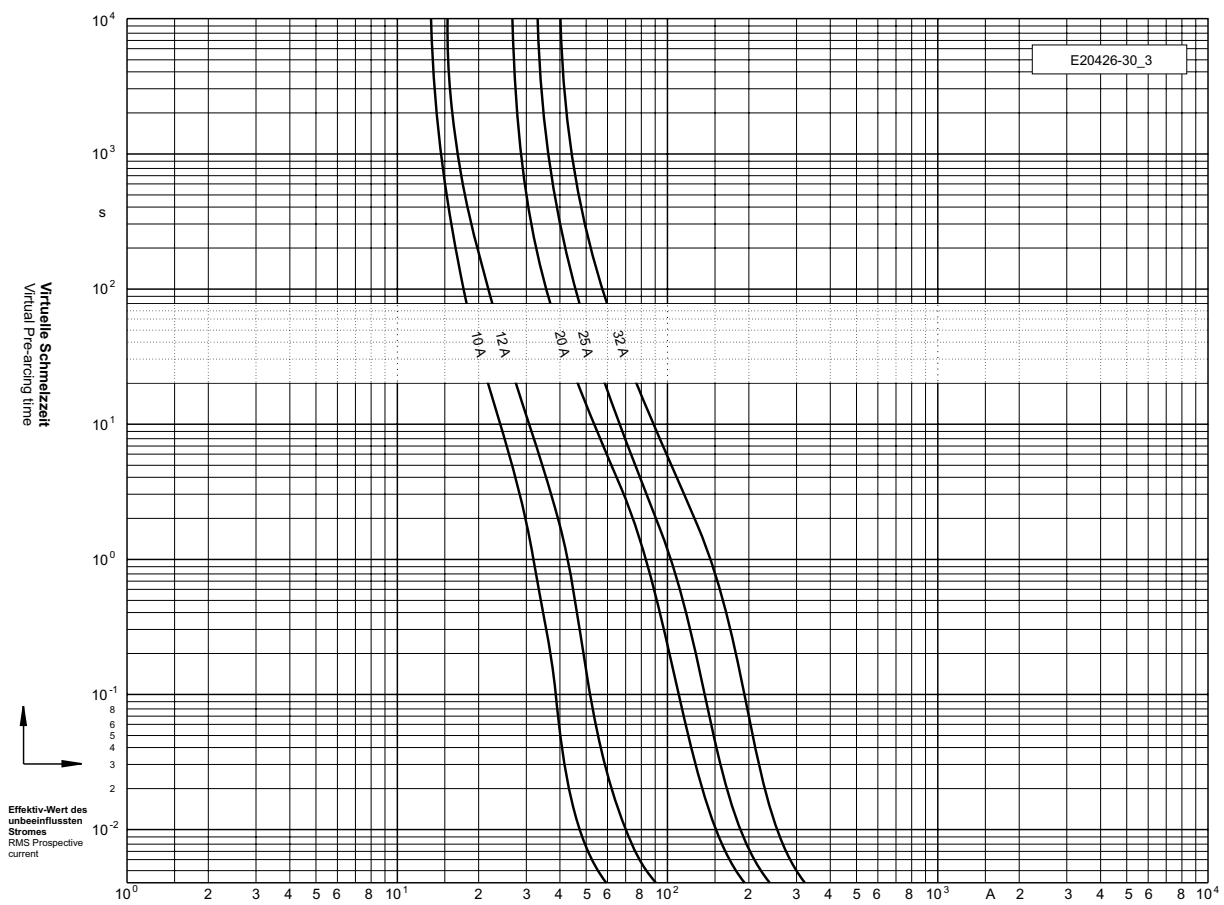

**DC 1000 V Ø 10 x 38 mm**

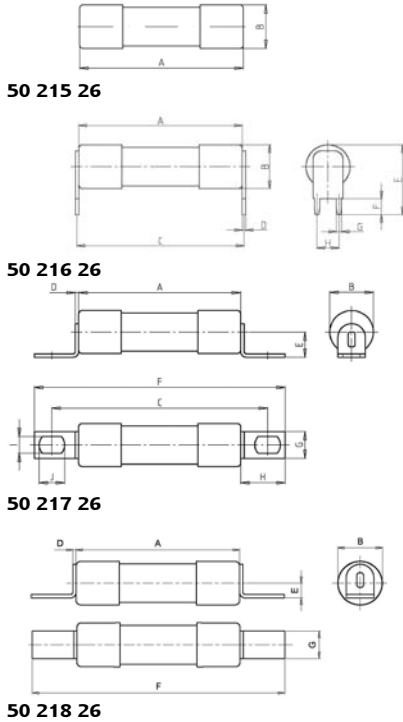
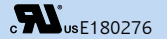

Verpackungseinheit / Packing unit: 10 Stück / 10 pieces

Betriebsklasse / Class <b>gPV (I<sub>f</sub> = 1,45 x I<sub>N</sub>) / IEC gR/UL</b>	<b>IEC 60 269-6 UL 248-13</b>
---	-----------------------------------

Bemessungs- spannung Rated Voltage	Artikel Nr. Article No	
V		
DC 1000	50 215 26	
	50 216 26	mit Einlötpins with soldering contacts
	50 217 26	mit Anschraub- laschen with bolted contacts
	50 218 26	für Kabelmontage for cable connection

**Bemessungsausschaltvermögen / Rated breaking capacity 30 kA DC 1000 V  
L/R = 2 m**

Bemessungs- strom Rated Current	Artikel Nr. Article No.				Gewicht Weight	Be- messungs- spannung Rated Voltage	Be- messungs- spannung Rated Voltage	Schmelz- integral Pre-Arcing- I <sup>2</sup> t-Value	Leistungs- abgabe Power Loss
		mit Einlötpins with soldering contacts	mit Anschraub- laschen with bolted contacts	für Kabel- montage for cable connections					
A					kg / 1	V	V	A <sup>2</sup> s	W
1	50 215 26.1	50 216 26.1	50 217 26.1	50 218 26.1	0,01	DC 1000	DC 1000	0,33	0,8
1,6	50 215 26.1,6	50 216 26.1,6	50 217 26.1,6	50 218 26.1,6	0,01	DC 1000	DC 1000	1,5	1,1
2	50 215 26.2	50 216 26.2	50 217 26.2	50 218 26.2	0,01	DC 1000	DC 1000	3	1,2
3	50 215 26.3	50 216 26.3	50 217 26.3	50 218 26.3	0,01	DC 1000	DC 1000	12	1,6
3,5	50 215 26.3,5	50 216 26.3,5	50 217 26.3,5	50 218 26.3,5	0,01	DC 1000	DC 1000	8	1,5
4	50 215 26.4	50 216 26.4	50 217 26.4	50 218 26.4	0,01	DC 1000	DC 1000	10	1,8
5	50 215 26.5	50 216 26.5	50 217 26.5	50 218 26.5	0,01	DC 1000	DC 1000	20	2
6	50 215 26.6	50 216 26.6	50 217 26.6	50 218 26.6	0,01	DC 1000	DC 1000	45	2,5
8	50 215 26.8	50 216 26.8	50 217 26.8	50 218 26.8	0,01	DC 1000	DC 1000	5	1,6
10	50 215 26.10	50 216 26.10	50 217 26.10	50 218 26.10	0,01	DC 1000	DC 1000	7	2,0
12	50 215 26.12	50 216 26.12	50 217 26.12	50 218 26.12	0,01	DC 1000	DC 1000	10	2,4
15	50 215 26.15	50 216 26.15	50 217 26.15	50 218 26.12	0,01	DC 1000	DC 1000	30	1,9
16	50 215 26.16	50 216 26.16	50 217 26.16	50 218 26.16	0,01	DC 1000	DC 1000	30	2,1
20	50 215 26.20	50 216 26.20	50 217 26.20	50 218 26.20	0,01	DC 1000	DC 1000	52	2,5

Applikationskoeffizienten / Application coefficients (Weiterführende Informationen siehe Seite 13 / for more information see page 13)

a	A2	B1 max.	B2	CF3
130	0,9	1,25	0,5	0,8

**DC 1000 V Ø 10 x 38 mm** c  usE180276

**Zeit/Strom-Kennlinien**  
Time-current characteristics

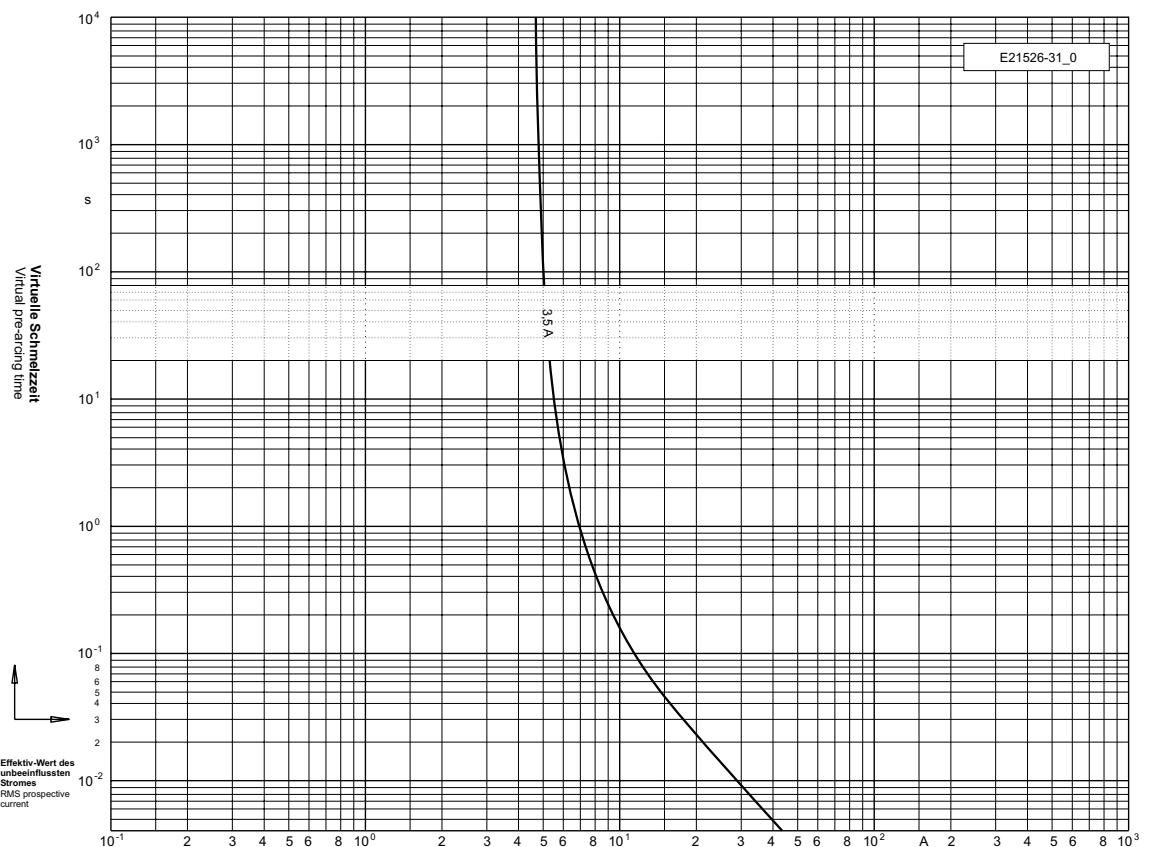
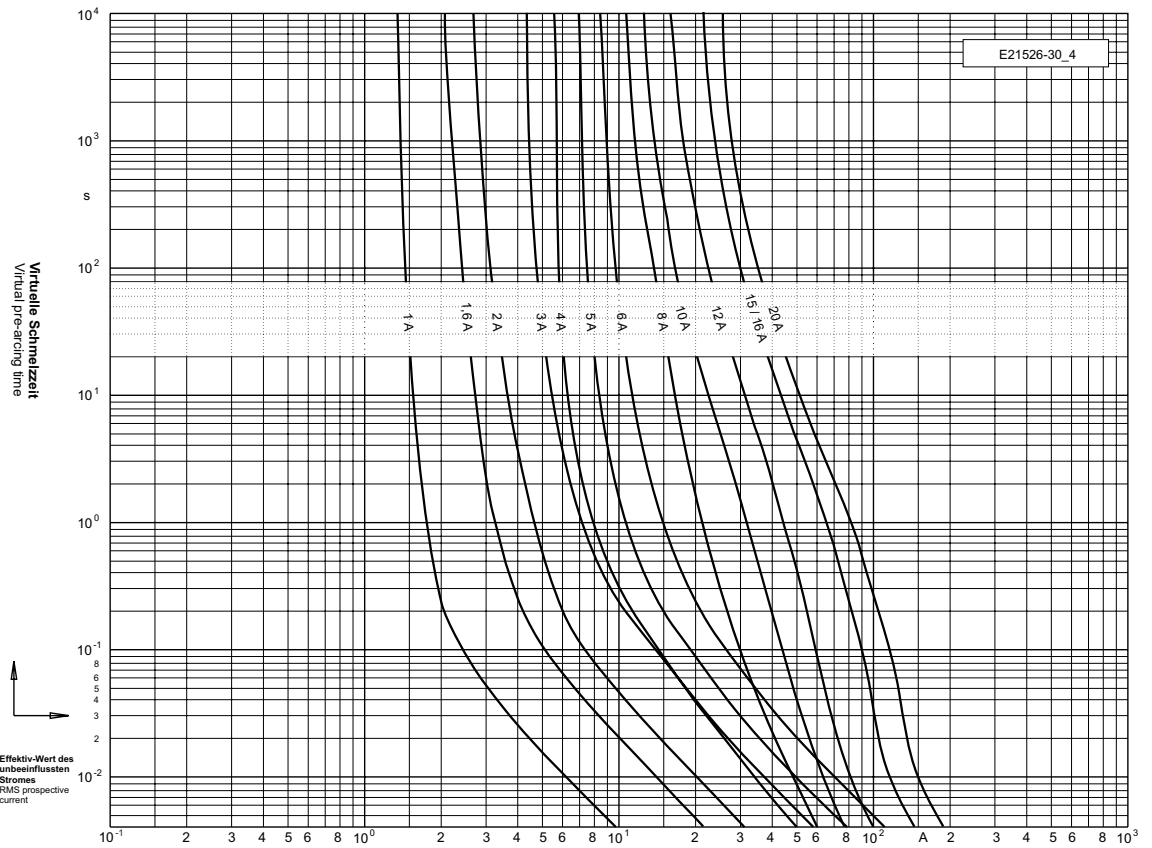

**DC 1000 V Ø 10 x 38 mm**

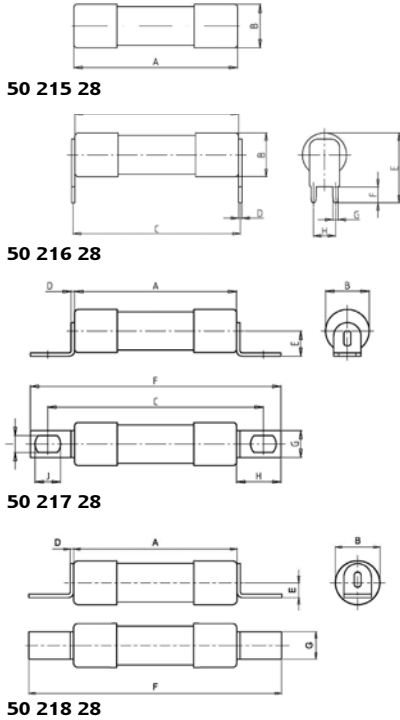
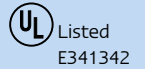

Verpackungseinheit / Packing unit: 10 Stück / 10 pieces

Betriebsklasse / Class <b>gPV</b>	<b>IEC 60 269-6</b> <b>UL 2579</b>
--------------------------------------	---------------------------------------

Bemessungs- spannung Rated Voltage	Artikel Nr. Article No	
V		
DC 1000	50 215 28	
	50 216 28	mit Einlötpins with soldering contacts
	50 217 28	mit Anschraub- laschen with bolted contacts
	50 218 28	für Kabelmontage for cable connection

Bemessungsausschaltvermögen / Rated breaking capacity 30 kA DC 1000 V  
L/R = 1-3 ms

Bemessungs- strom Rated Current	Artikel Nr. Article No.				Gewicht Weight	Bemes- sungsspan- nung Rated Voltage	Bemes- sungsspan- nung Rated Voltage	Schmelz- integral Pre-Arcing- I <sup>2</sup> t-Value	Leistungs- abgabe Power Loss
		mit Einlötpins with soldering contacts	mit Anschraub- laschen with bolted contacts	für Kabel- montage for cable connections					
A					kg / 1	V	V	A <sup>2</sup> s	W
3,5				50 218 28.3,5	0,01	DC 1000	DC 1000	0,33	0,8
4				50 218 28.4	0,01	DC 1000	DC 1000	10	1,8
5				50 218 28.5	0,01	DC 1000	DC 1000	20	2,0
8	50 215 28.8	50 216 28.8	50 217 28.8	50 218 28.8	0,01	DC 1000	DC 1000	3	1,9
10	50 215 28.10	50 216 28.10	50 217 28.10	50 218 28.10	0,01	DC 1000	DC 1000	5	2,3
12	50 215 28.12	50 216 28.12	50 217 28.12	50 218 28.12	0,01	DC 1000	DC 1000	9	2,9
15	50 215 28.15	50 216 28.15	50 217 28.15	50 218 28.15	0,01	DC 1000	DC 1000	17	3,3
16	50 215 28.16	50 216 28.16	50 217 28.16	50 218 28.16	0,01	DC 1000	DC 1000	20	3,4
20	50 215 28.20	50 216 28.20	50 217 28.20	50 218 28.20	0,01	DC 1000	DC 1000	40	3,9
22,4	50 215 28.22,4	50 216 28.22,4	50 217 28.22,4	50 218 28.22,4	0,01	DC 1000	DC 1000	52	4,5

Applikationskoeffizienten / Application coefficients (Weiterführende Informationen siehe Seite 13 / for more information see page 13)

a	A2	B1 max.	B2	CF3
130	0,8	1,25	0,5	0,8

**DC 1000 V Ø 10 x 38 mm** 

**Zeit/Strom-Kennlinien**  
Time-current characteristics

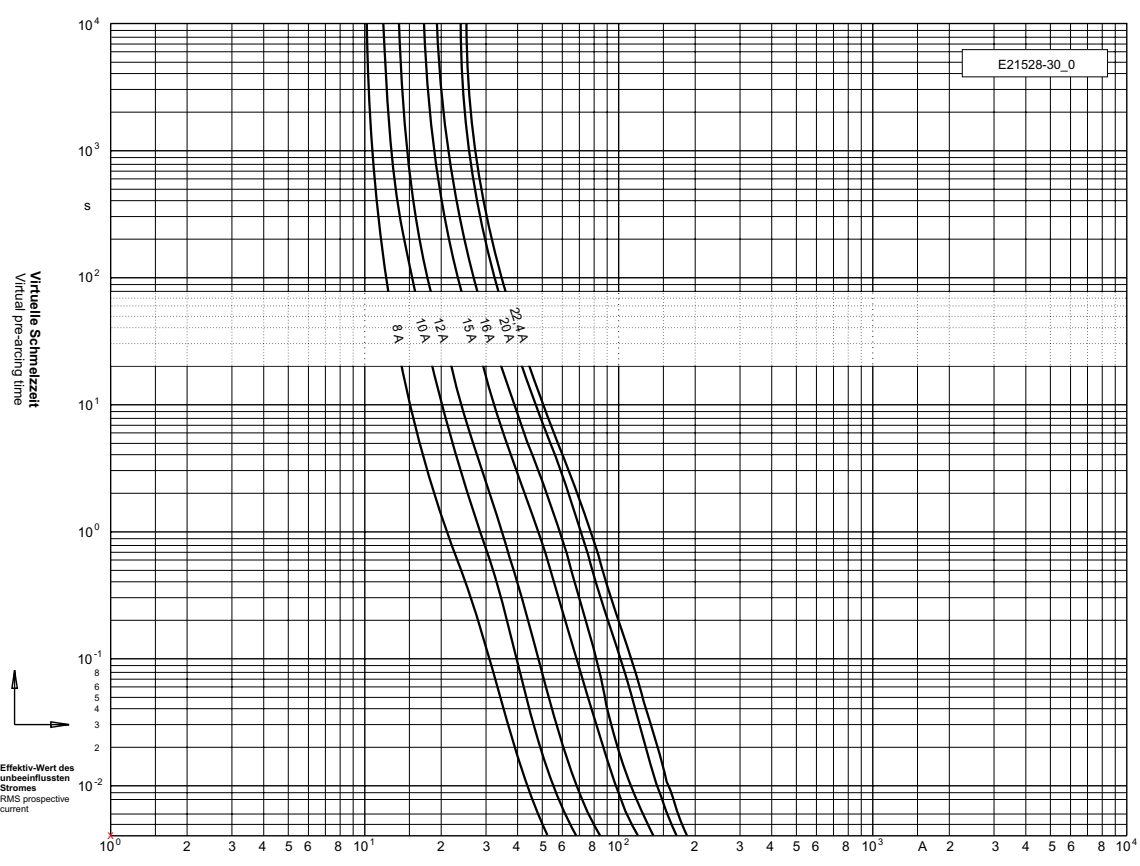
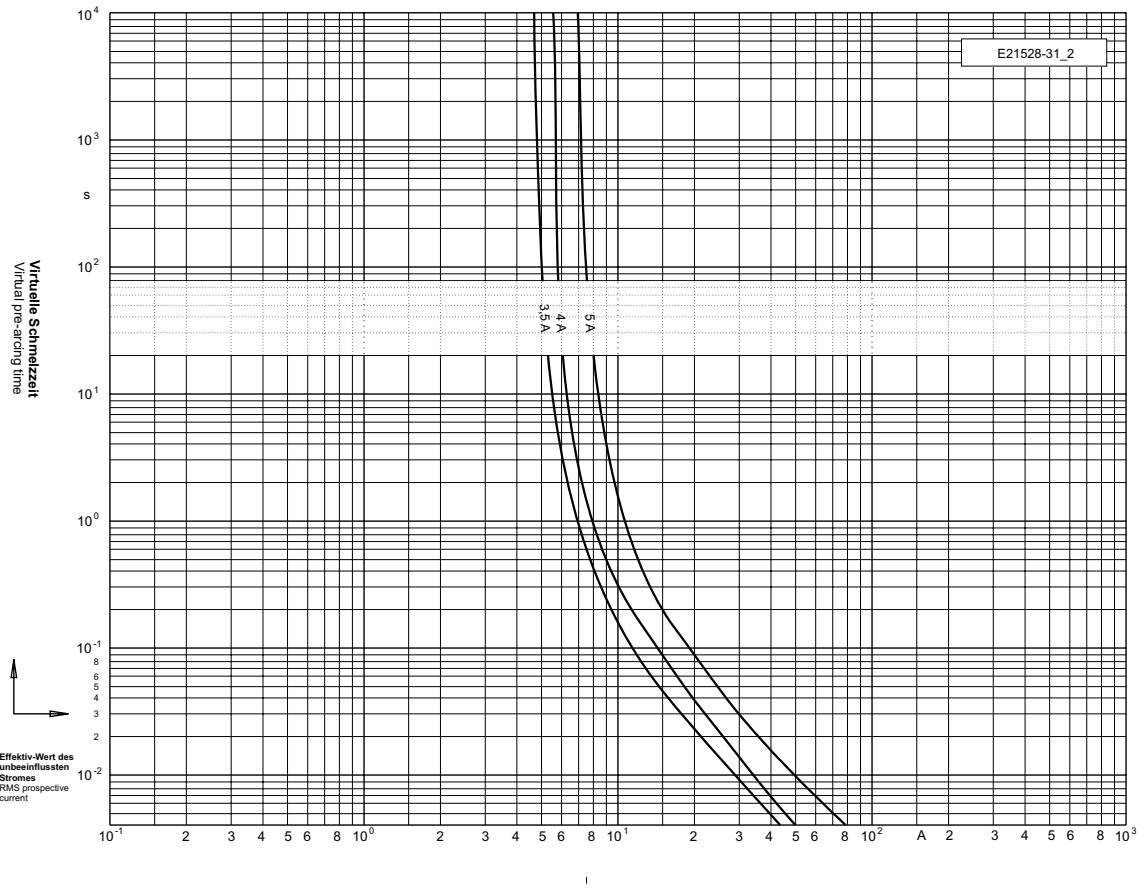

**DC 1000 V Ø 24 x 150 mm**

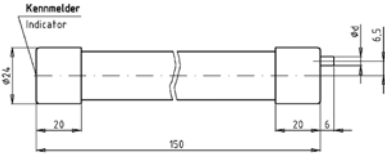

Verpackungseinheit / Packing unit: 1 Stück / 1 pieces

Charakteristik / Class <b>F flink</b>
--

Bemessungsspannung Rated Voltage	Artikel Nr. Article No	Größe Size	Bemessungsstrom Rated Current
V			A
DC 1000	90 078 10	Ø 24 x 150 mm	6,3-20

Bemessungsausschaltvermögen / Rated breaking capacity **10 kA**

Bemessungsstrom Rated Current	Artikel Nr. Article No.	Gewicht Weight	Kennmelderfarbe Indicator colour	Durchmesser Ø	Schmelzintegral Pre-Arcing-I <sup>2</sup> t-Value	Ausschaltintegral Total I <sup>2</sup> t-Value @ DC 1200 V	Leistungsabgabe Power Loss
A		kg / 1			A <sup>2</sup> s	A <sup>2</sup> s	W
6,3	90 078 10.6,3	0,15	grün / green	-	20	80	2,4
10	90 078 10.10	0,15	rot / red	4	32	130	5,1
16	90 078 10.16	0,15 0,15	grau / grey	6	220	880	5,2
20	90 078 10.20		blau / blue	8	330	1.400	6,1

Applikationskoeffizienten / Application coefficients (Weiterführende Informationen siehe Seite 13 / for more information see page 13)

a	A2	B1 max.	B2	Cf3
130	0,9	1,25	0,5	0,8



**DC 1000 V Ø 24 x 150 mm**

**Zeit/Strom-Kennlinien**  
Time-current characteristics

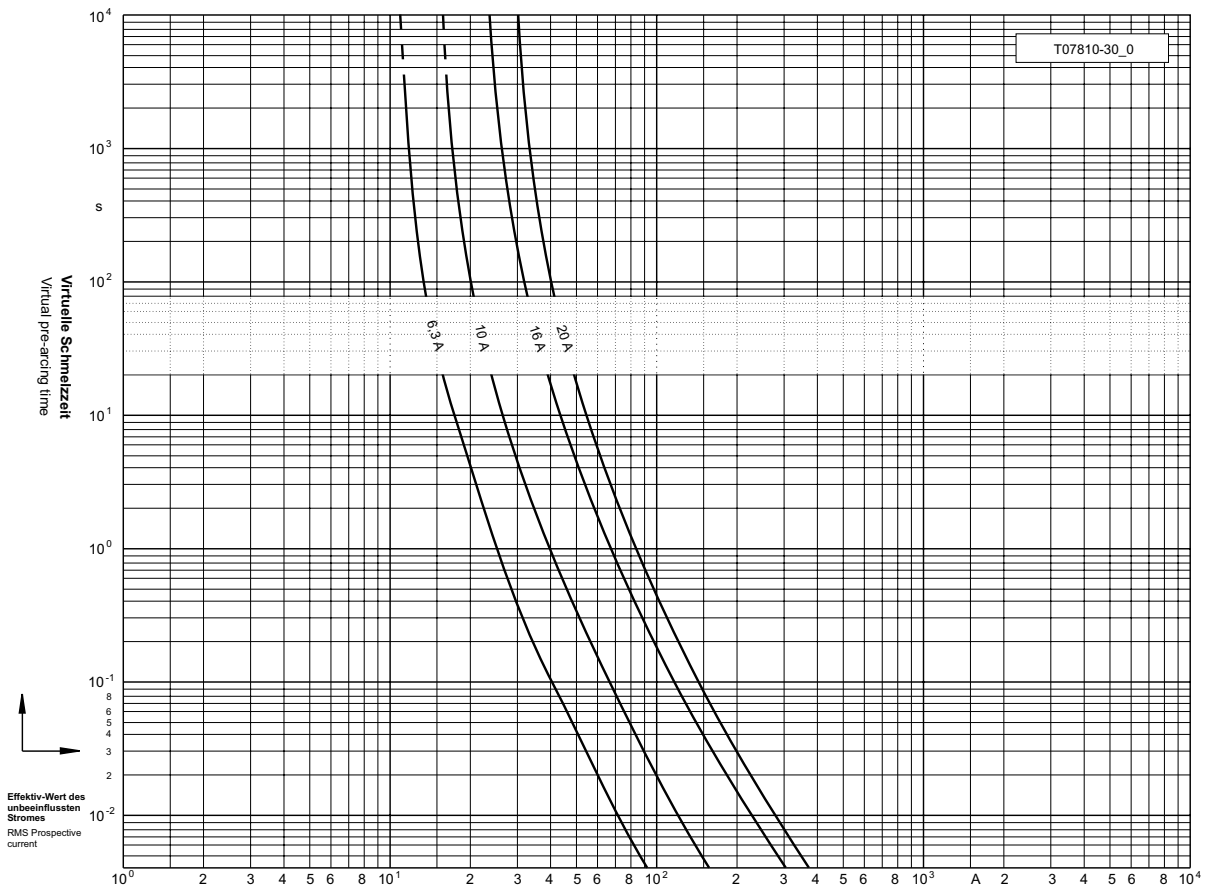

**Durchlass-Strom**  
Cut-off current

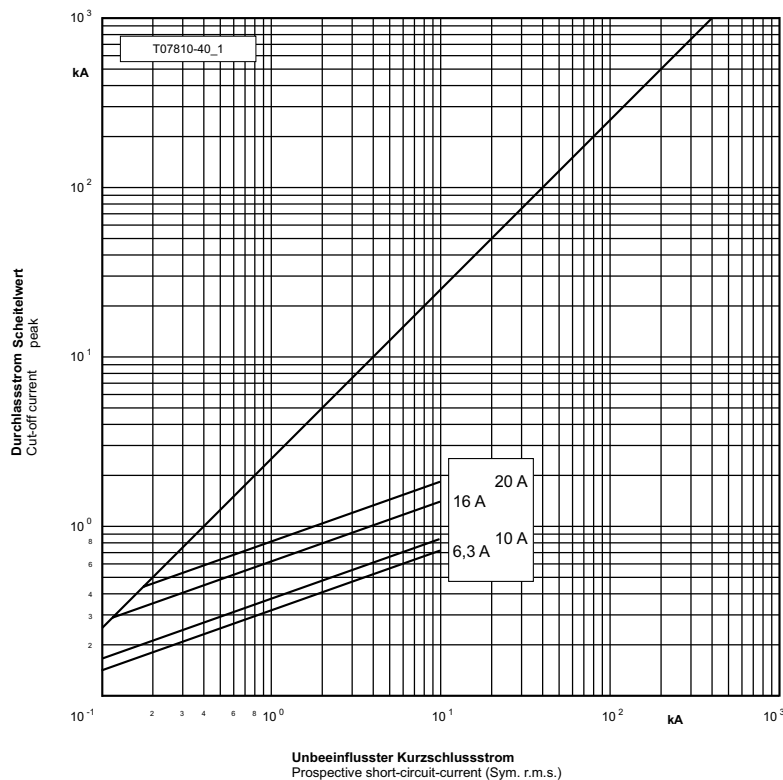

**DC 1000 V Ø 34,5 x 195 mm**

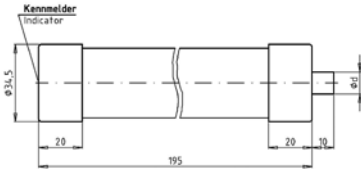

Verpackungseinheit / Packing unit: 1 Stück / 1 pieces

Charakteristik / Class <b>F</b> flink	Werksnorm company standard
---	-------------------------------

Bemessungsspannung Rated Voltage	Artikel Nr. Article No	Größe Size	Bemessungsstrom Rated Current
V			A
DC 1000	90 077 10	Ø 34,5 x 195 mm	10-60

Bemessungsausschaltvermögen / Rated breaking capacity **10 kA**

Bemessungsstrom Rated Current	Artikel Nr. Article No.	Gewicht Weight	Kennmelderfarbe Indicator colour	Durchmesser Ø	Schmelzintegral Pre-Arcing-I <sup>2</sup> t-Value	Ausschaltintegral Total I <sup>2</sup> t-Value @ DC 1000 V	Leistungsabgabe Power Loss
A		kg / 1			A <sup>2</sup> s	A <sup>2</sup> s	W
10	90 077 10.10	0,50	rot / red	6	30	130	6,8
25	90 077 10.25	0,50	gelb / yellow	10	1.100	4.300	9,3
35	90 077 10.35	0,50	schwarz / black	13	1.500	5.900	9,5
50	90 077 10.50	0,50	weiß / white	16	4.100	16.200	12
60	90 077 10.60	0,50	kupfer / copper	19	5.200	20.800	15

Applikationskoeffizienten / Application coefficients (Weiterführende Informationen siehe Seite 13 / for more information see page 13)

a	A2	B1 max.	B2	Cf3
130	0,9	1,25	0,5	0,8

**DC 1000 V Ø 34,5 x 195 mm**

**Zeit/Strom-Kennlinien**  
Time-current characteristics

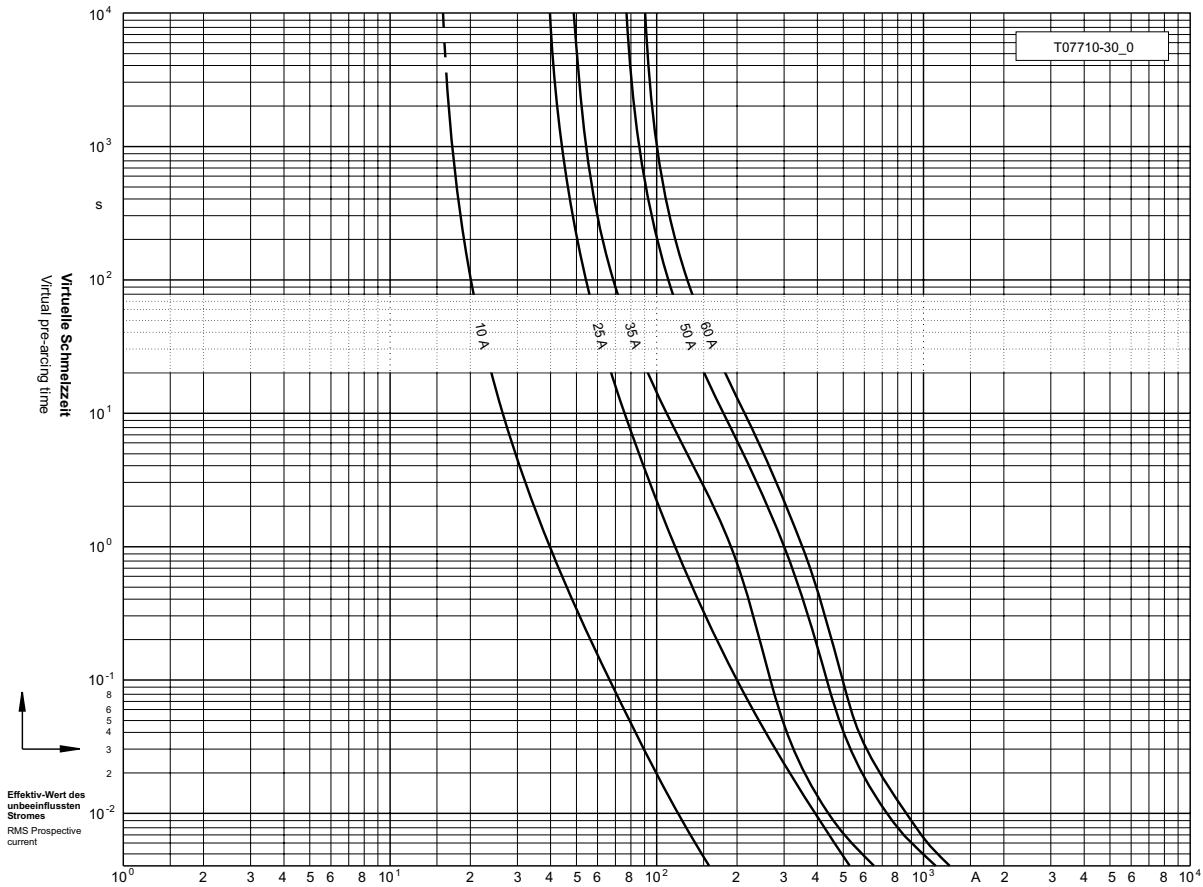

**Durchlass-Strom**  
Cut-off current

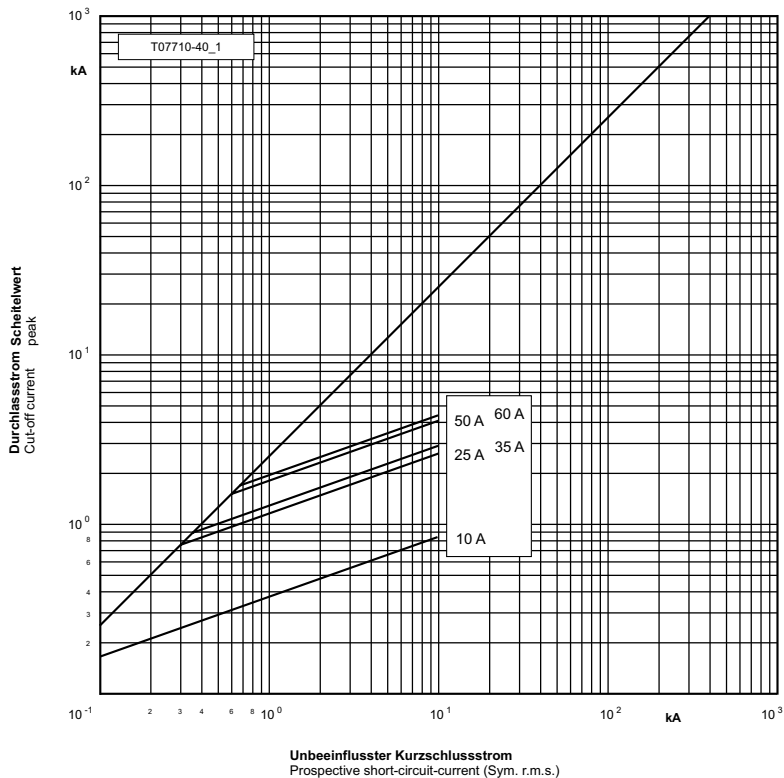

**DC 1000 V Ø 20 x 127 mm**

Verpackungseinheit / Packing unit: 12 Stück / 12 pieces

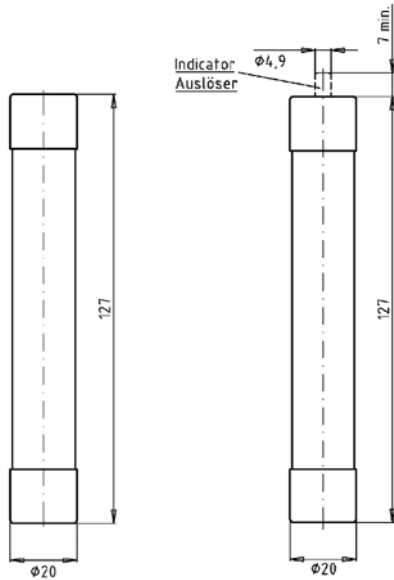

90 080 10

90 082 10

Betriebsklasse / Class <b>aR gR</b>	<b>EN IEC 60 269-4 DIN VDE 0636-40</b>
--	--

Bemessungs- spannung Rated Voltage	Artikel Nr. Article No	Größe Size	Bemessungsstrom ohne Kennmelder Rated Current without indicator	Bemessungsstrom mit Kennmelder Rated Current with indicator
V			A	A
DC 1000	90 080 10	20 x 127 mm	< 6	6-63

Bemessungs- spannung Rated Voltage	Artikel Nr. Article No	Größe Size	Bemessungsstrom mit Auslöser Rated Current with striker pinr
V			A
DC 1000	90 082 10	20 x 127 mm	6-63

**Bemessungsausschaltvermögen / Rated breaking capacity 30 kA**

Bemessungsstrom Rated Current	Artikel Nr. Article No.		Gewicht Weight	Betriebsklasse Operating class	Schmelzintegral Pre-Arcing- I <sup>2</sup> t-Value	Ausschalt- integral Total I <sup>2</sup> t-Value	Leistungsabgabe Power Loss
						@ DC 1000 V	
A	Kennmelder	Striker 2,5 N	kg / 1		A <sup>2</sup> s	A <sup>2</sup> s	W
3,15	90 080 10.3,15		0,10	aR	2	13	4,1
6	90 080 10.6	90 082 10.6	0,10	gR	3	17	3,0
8	90 080 10.8	90 082 10.8	0,10	gR	7	42	3,2
10	90 080 10.10	90 082 10.10	0,10	gR	13	75	3,4
12	90 080 10.12	90 082 10.12	0,10	gR	20	120	4,6
16	90 080 10.16	90 082 10.16	0,10	gR	52	300	5,7
20	90 080 10.20	90 082 10.20	0,10	gR	82	470	6,8
25	90 080 10.25	90 082 10.25	0,10	gR	118	670	8,1
32	90 080 10.32	90 082 10.32	0,10	gR	184	1.050	10
40	90 080 10.40	90 082 10.40	0,10	gR	472	2.700	12
50	90 080 10.50	90 082 10.50	0,10	gR	737	4.200	13
63	90 080 10.63	90 082 10.63	0,10	gR	1.300	7.500	18

Applikationskoeffizienten / Application coefficients (Weiterführende Informationen siehe Seite 13 / for more information see page 13)

a	A2	B1 max.	B2	Cf3
130	0,6	1,25	0,6	0,8

**DC 1000 V Ø 20 x 127 mm**

**Zeit/Strom-Kennlinien**  
Time-current characteristics

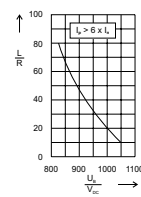
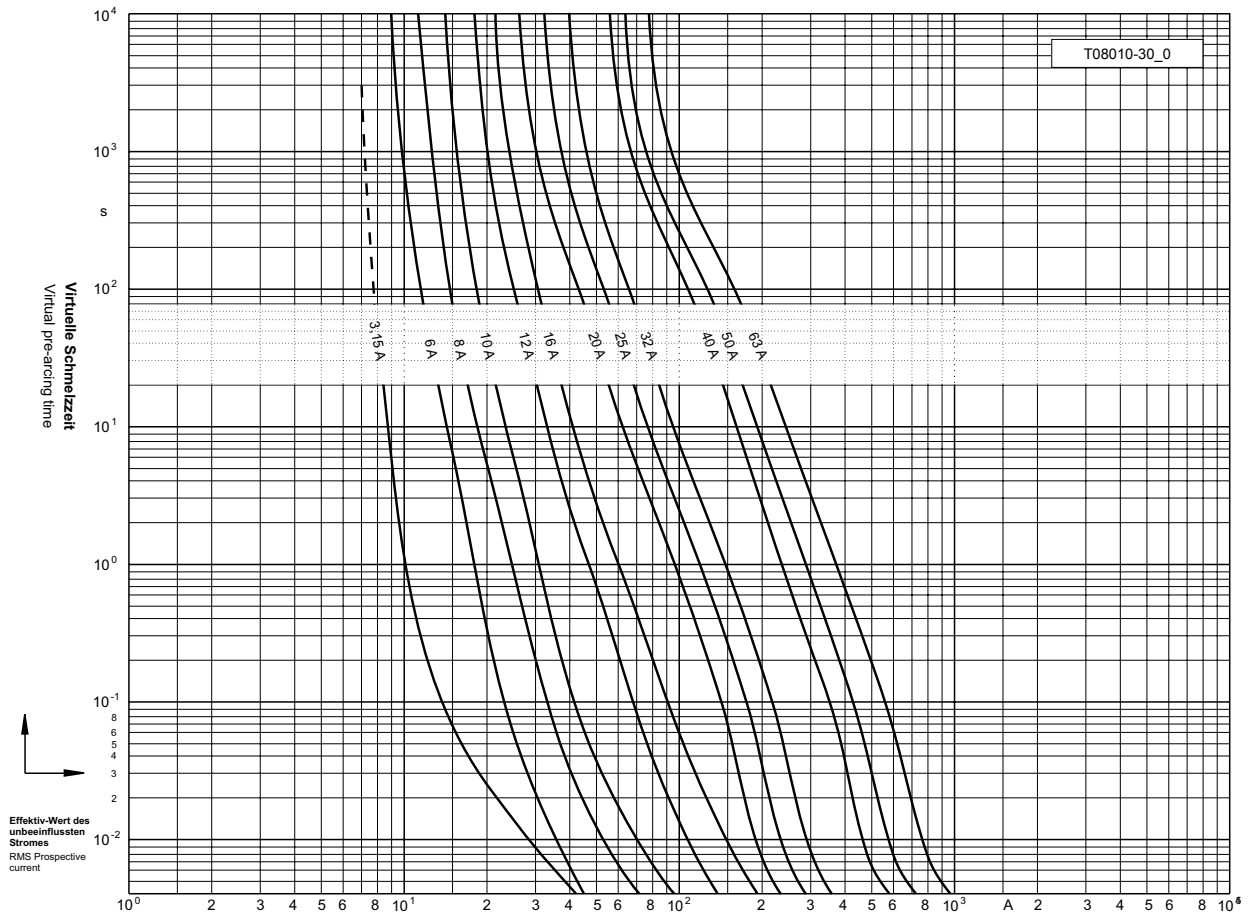

**Umrechnungsfaktor für den Ausschalt  $i^2t$ -Wert**  
Reduction factor for total  $i^2t$ -value

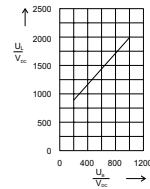

**Schaltspannungsdiagramm**  
Arc Voltage-Diagram

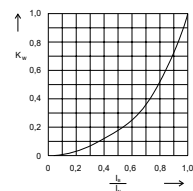

**Umrechnungsfaktor der Leistungsabgabe**  
Reduction factor for power Loss

**DC 1000 V Ø 36 x 127 mm**

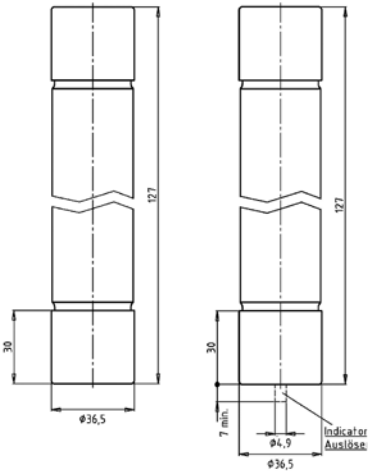

90 092 10

90 093 10

Verpackungseinheit / Packing unit: 3 Stück / 3 pieces

Betriebsklasse / Class <b>gR</b>	in Anlehnung an / in compliance with: <b>VDE 0636-1 und -4</b>
-------------------------------------	---

Bemessungs- spannung Rated Voltage	Artikel Nr. Article No	Größe Size	Bemessungs- strom Rated Current	Länge L Length L	Durchmesser D Diameter D
V			A	mm	mm
DC 1000	90 092 10	36 x 127	20-100	127	36,5
	90 093 10		20-100	127	36,5

Bemessungsausschaltvermögen / Rated breaking capacity 30 kA (L/R = 15ms)

Bemessungsstrom Rated Current	Artikel Nr. Article No.		Gewicht Weight	Schmelzintegral Pre-Arcing- I <sup>2</sup> t-Value	Ausschaltintegral Total I <sup>2</sup> t-Value @ DC 1000 V L/R=10 ms	Leistungsabgabe * Power Loss
	Ohne Auslöser/ without striker	Mit Auslöser/ with striker				
	A					
20	90 092 10.20	90 093 10.20	0,39	63	540	6
25	90 092 10.25	90 093 10.25	0,39	104	850	7
32	90 092 10.32	90 093 10.32	0,39	180	1.550	8
40	90 092 10.40	90 093 10.40	0,39	415	3.600	9
50	90 092 10.50	90 093 10.50	0,39	740	6.500	13
63	90 092 10.63	90 093 10.63	0,39	1.000	8.800	17
80	90 092 10.80	90 093 10.80	0,39	2.050	18.300	20
100	90 092 10.100	90 093 10.100	0,39	3.500	31.500	26

Applikationskoeffizienten / Application coefficients (Weiterführende Informationen siehe Seite 13 / for more information see page 13)

a	A2	B1 max.	B2	Cf3
130	0,6	1,25	0,6	0,8

**DC 1000 V Ø 36 x 127 mm**

**Zeit/Strom-  
Kennlinien**  
Time-current  
characteristics

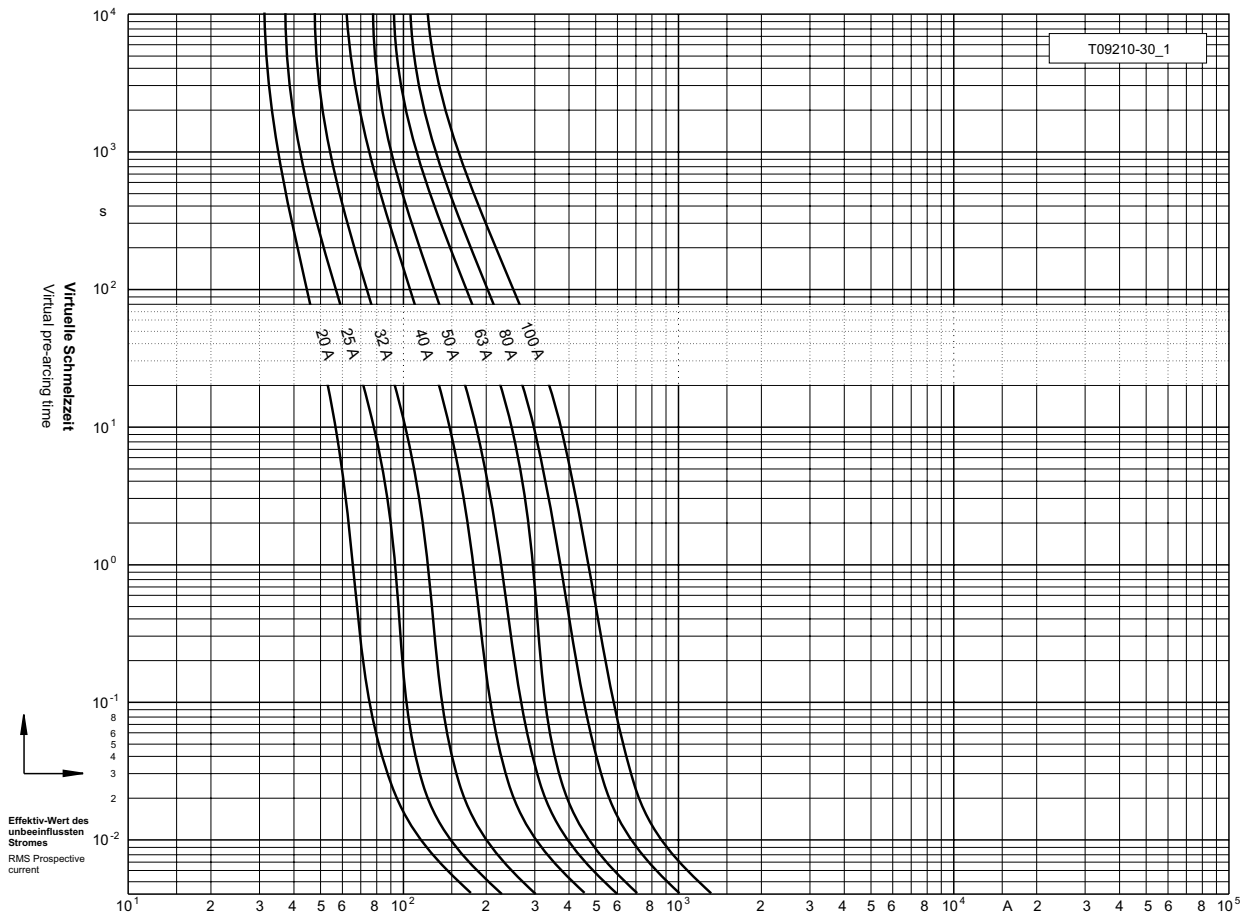

**DC 1100 V Ø 14 x 65 mm**



50 235 26

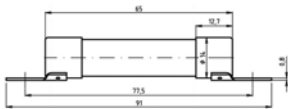

50 237 26



50 238 26

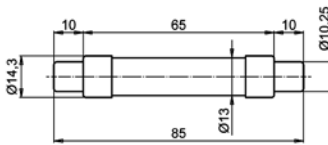

50 239 26

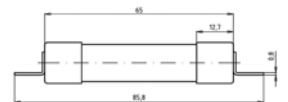

Verpackungseinheit / Packing unit: 10 Stück / 10 pieces

Betriebsklasse / Class <b>gPV</b>	<b>IEC 60 269-6</b>	<b>Entwurf Stand 2009</b> proposal issued 2009
--------------------------------------	---------------------	---

Bemessungs- spannung Rated Voltage	Artikel Nr. Article No	
V		
DC 1100	50 235 26	14 x 65 mm
	50 237 26	mit Anschraub- laschen with bolted contacts
	50 238 26	10/14 x 85
	50 239 26	mit Anschraub- laschen with bolted contacts

**Bemessungsausschaltvermögen / Rated breaking capacity 30 kA DC 1100 V**  
L/R = 1 ms

Bemessungs- strom Rated Current	Artikel Nr. Article No.				Gewicht Weight	Be- messungs- spannung Rated Voltage	Schmelz- integral Pre-Arcing- I <sup>2</sup> t-Value	Ausschalt- integral Total I <sup>2</sup> t-Value	Leistungs- abgabe Power Loss
		mit Anschraub- laschen with bolted contacts		für Kabel- montage for cable connection					
A					kg / 1	V	A <sup>2</sup> s	A <sup>2</sup> s	W
8	50 235 26.8	50 237 26.8	50 238 26.8	50 239 26.8	0,03	DC 1100	5	22	2,6
10	50 235 26.10	50 237 26.10	50 238 26.10	50 239 26.10	0,03	DC 1100	5	24	3,3
12	50 235 26.12	50 237 26.12	50 238 26.12	50 239 26.12	0,03	DC 1100	13	62	3,5
16	50 235 26.16	50 237 26.16	50 238 26.16	50 239 26.16	0,03	DC 1100	30	143	3,8
20	50 235 26.20	50 237 26.20	50 238 26.20	50 239 26.20	0,03	DC 1100	53	250	4,7
25	50 235 26.25	50 237 26.25	50 238 26.25	50 239 26.25	0,03	DC 1100	82	560	5,9
30	50 235 26.30	50 237 26.30	50 238 26.30	50 239 26.30	0,03	DC 1000	118	950	7,5

Applikationskoeffizienten / Application coefficients (Weiterführende Informationen siehe Seite 13 / for more information see page 13)

a	A2	B1 max.	B2	Cf3
130	0,9	1,25	0,5	0,8



**DC 1100 V Ø 14 x 65 mm**

**Zeit/Strom-  
Kennlinien**  
Time-current  
characteristics

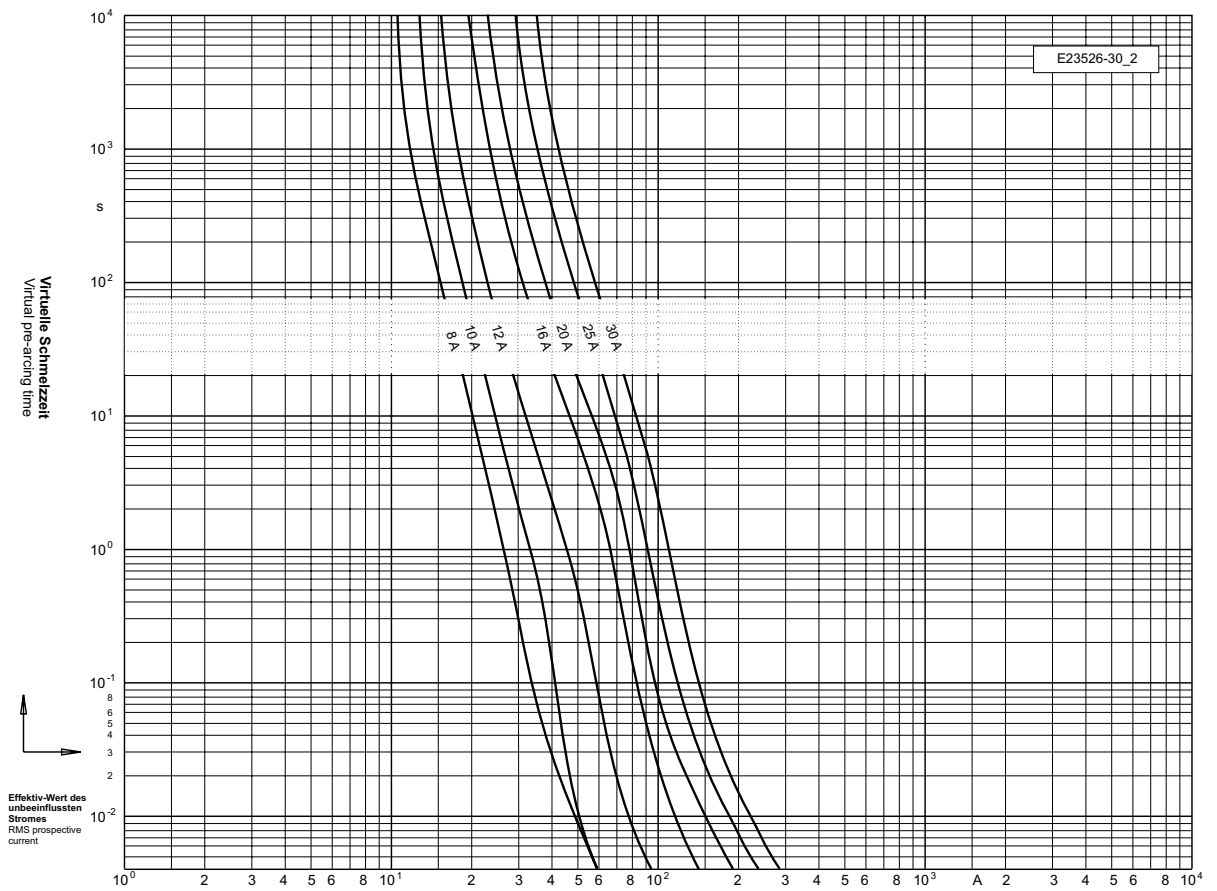

**DC 1100 V Ø 14 x 65 mm**



50 235 28



50 237 28



50 238 28

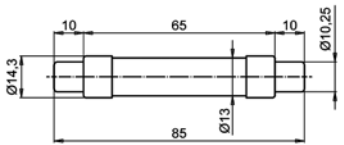

50 239 28



Verpackungseinheit / Packing unit: 10 Stück / 10 pieces

Betriebsklasse / Class <b>gPV</b>	<b>IEC 60 269-6</b> <b>UL 2579</b>
--------------------------------------	---------------------------------------

Bemessungs- spannung Rated Voltage	Artikel Nr. Article No	
V		
DC 1100	50 235 28	14 x 65 mm
	50 237 28	mit Anschraub- laschen with bolted contacts
	50 238 28	10/14 x 85 mm
	50 239 28	mit Anschraub- laschen with bolted contacts

Bemessungsausschaltvermögen / Rated breaking capacity 30 kA DC 1100 V  
L/R = 1-3 ms

Bemessungs- strom Rated Current	Artikel Nr. Article No.				Gewicht Weight	Bemessungs- spannung Rated Voltage	Schmelz- integral Pre-Arcing- I <sup>2</sup> t-Value	Ausschalt- integral Total I <sup>2</sup> t-Value	Leistungs- abgabe Power Loss
		mit Anschraub- laschen with bolted contacts		mit Anschraub- laschen with bolted contacts					
A					kg / 1	V	A <sup>2</sup> s	A <sup>2</sup> s	W
10	50 235 28.10	50 237 28.10	50 238 28.10	50 239 28.10	0,03	DC 1100	3	21	4,0
12	50 235 28.12	50 237 28.12	50 238 28.12	50 239 28.12	0,03	DC 1100	7,5	51	4,1
16	50 235 28.16	50 237 28.16	50 238 28.16	50 239 28.16	0,03	DC 1100	16	109	4,6
20	50 235 28.20	50 237 28.20	50 238 28.20	50 239 28.20	0,03	DC 1100	30	205	5,5
25	50 235 28.25	50 237 28.25	50 238 28.25	50 239 28.25	0,03	DC 1100	82	560	5,9

Applikationskoeffizienten / Application coefficients (Weiterführende Informationen siehe Seite 13 / for more information see page 13)

a	A2	B1 max.	B2	Cf3
130	0,8	1,25	0,5	0,8

**DC 1100 V Ø 14 x 65 mm** 

**Zeit/Strom-Kennlinien**  
Time-current characteristics

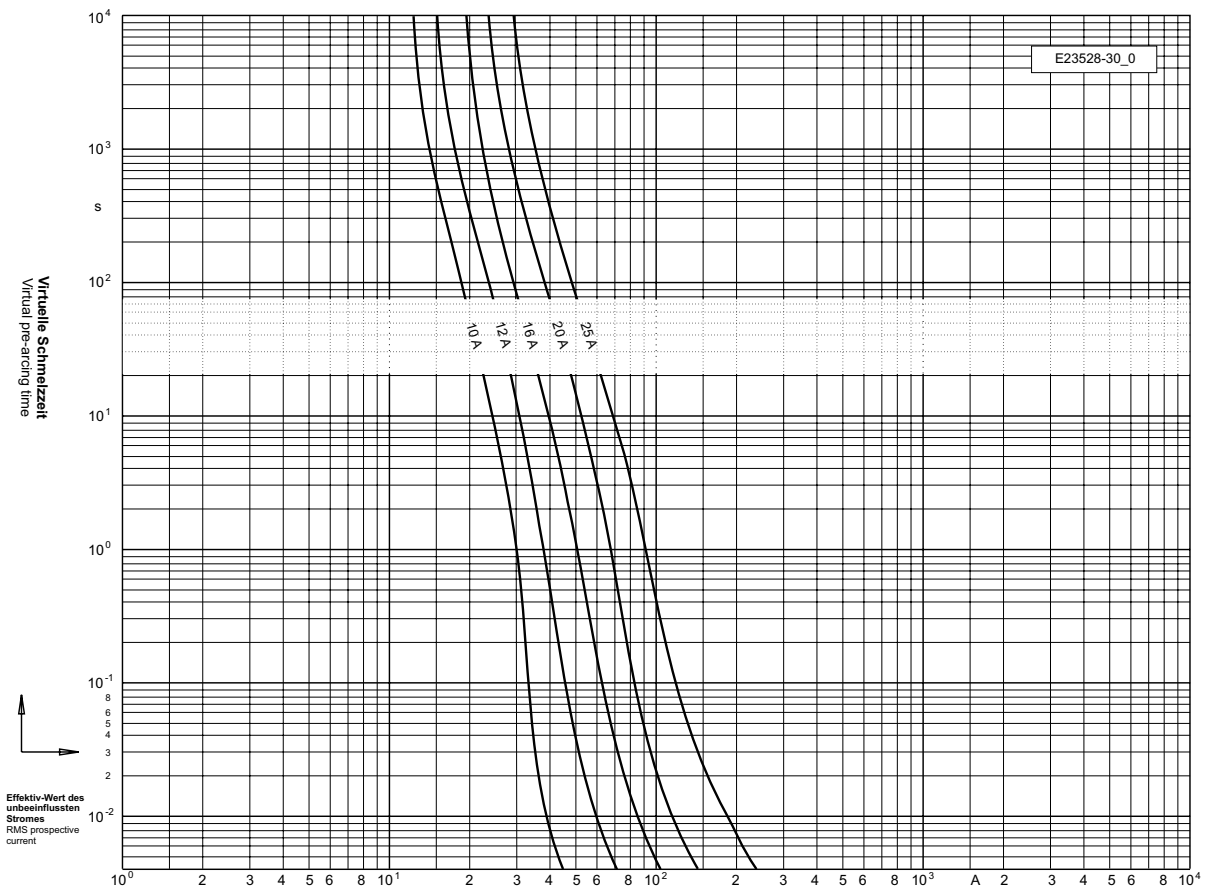

**DC 1200 V Ø 10 x 38 mm**



50 255 06

Verpackungseinheit / Packing unit: 10 Stück / 10 pieces

Betriebsklasse / Class <b>gR</b>	in Anlehnung an / in compliance with: <b>UL 248-13</b>
-------------------------------------	---

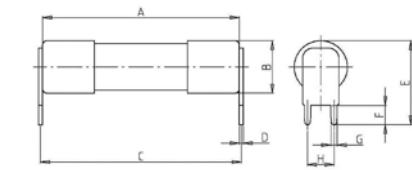

50 256 06

Bemessungs- spannung Rated Voltage	Artikel Nr. Article No	Größe Size	Bemessungsstrom Rated Current
V			A
DC 1200	50 255 06	10 x 38 mm	1
	50 256 06		

Bemessungsausschaltvermögen / Rated breaking capacity **30 kA**  
L/R = 3 ms

Bemessungsstrom Rated Current	Artikel Nr. Article No.	Gewicht Weight	Bemessungs- spannung Rated Voltage	Schmelzintegral Pre-Arcing- I <sup>2</sup> t-Value	Leistungs- abgabe Power Loss
A		kg / 1	V	A <sup>2</sup> s	W
1	50 255 06.1	0,01	DC 1200	0,32	3,5
		mit Einlötpins for PCB mounting			

Applikationskoeffizienten / Application coefficients (Weiterführende Informationen siehe Seite 13 / for more information see page 13)

a	A2	B1 max.	B2	CF3
130	0,6	1,25	0,5	0,8

**DC 1200 V Ø 10 x 38 mm**

Zeit/Strom-  
Kennlinien  
Time-current  
characteristics

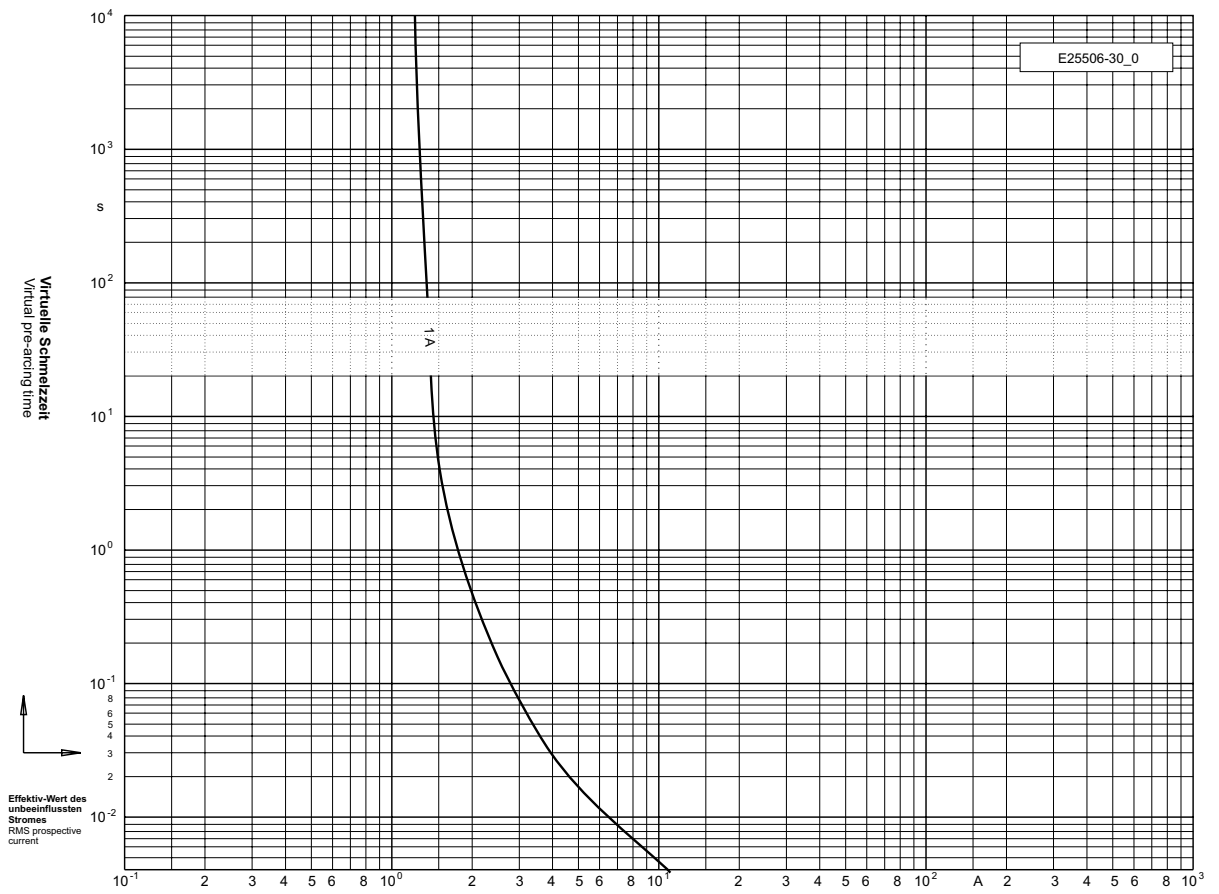

**DC 1500 V Ø 14 x 100 mm**

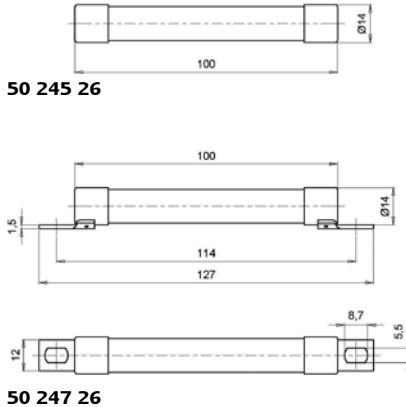

Verpackungseinheit / Packing unit: 10 Stück / 10 pieces

Betriebsklasse / Class <b>gPV</b>	<b>IEC 60 269-6</b>
--------------------------------------	---------------------

Bemessungs- spannung Rated Voltage	Artikel Nr. Article No
V	
DC 1500	50 245 26
	50 247 26 mit Anschraub- laschen with bolted contacts

Bemessungsausschaltvermögen / Rated breaking capacity **30 kA DC 1500 V**  
L/R = 3 ms

Bemessungsstrom Rated Current	Artikel Nr. Article No.	Gewicht Weight	Bemessungs- spannung Rated Voltage	Schmelz- integral Pre-Arcing- I <sup>2</sup> t-Value	Ausschalt- integral Total I <sup>2</sup> t-Value	Leistungs- abgabe Power Loss	
					@ tested Voltage		
			IEC 60269-6				
		mit Anschraub- laschen with bolted contacts					
A		kg / 1	V	A <sup>2</sup> s	A <sup>2</sup> s	W	
12	50 245 26.12	50 247 26.12	0,04	DC 1500	14	140	4,2
16	50 245 26.16	50 247 26.16	0,04	DC 1500	30	290	5,5
20	50 245 26.20	50 247 26.20	0,04	DC 1500	53	510	6,5
25	50 245 26.25	50 247 26.25	0,04	DC 1500	91	880	7,5

Applikationskoeffizienten / Application coefficients (Weiterführende Informationen siehe Seite 13 / for more information see page 13)

a	A2	B1 max.	B2	Cf3
130	0,9	1,25	0,5	0,8

**DC 1500 V Ø 14 x 100 mm**

**Zeit/Strom-  
Kennlinien**  
Time-current  
characteristics

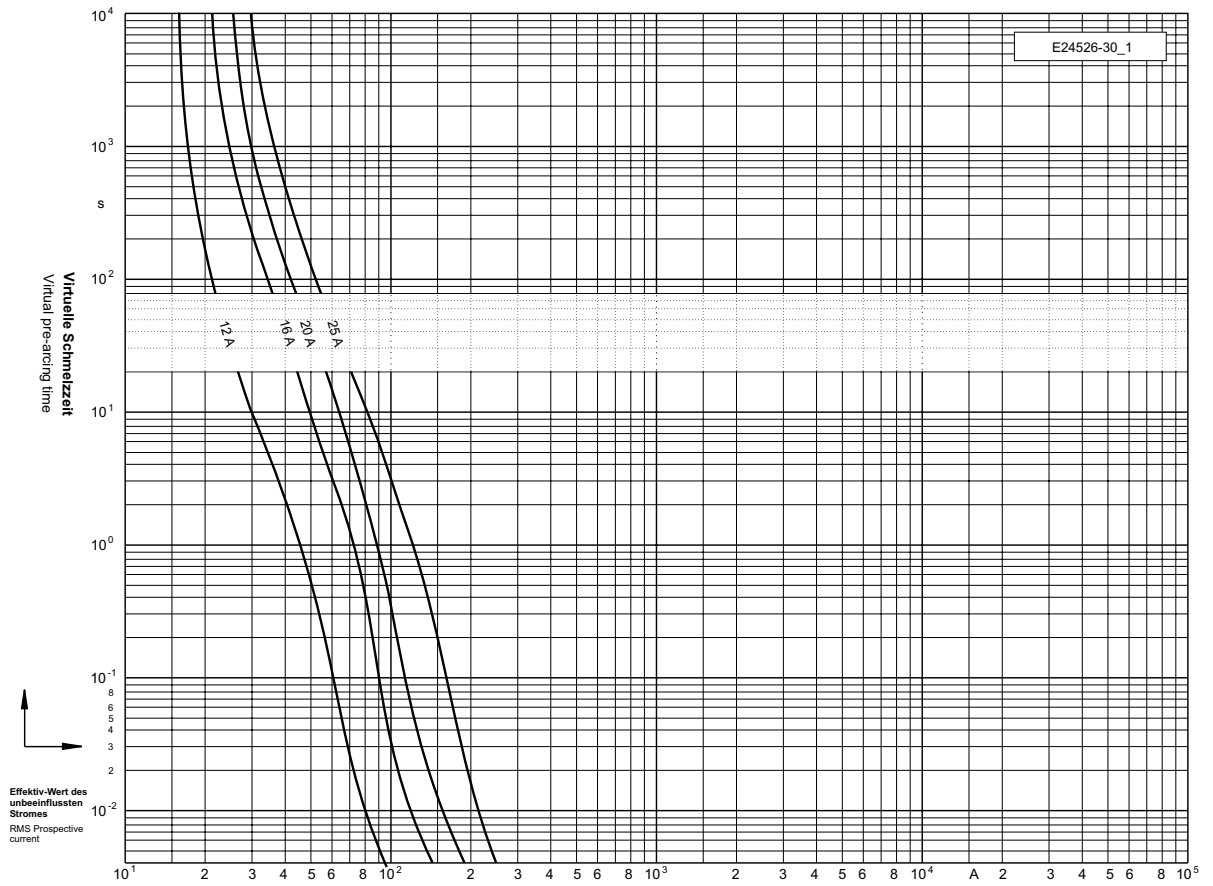

**DC 1500 V Ø 20 x 127 mm**

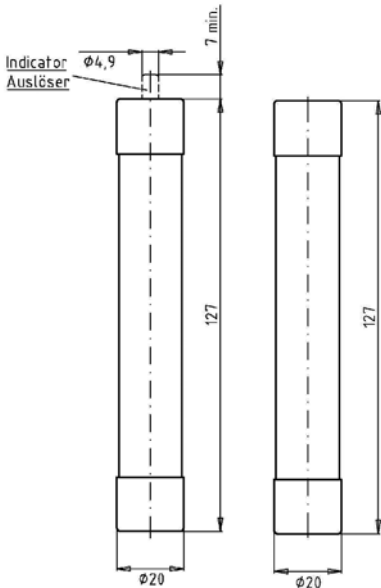

90 081 10    90 086 10

Verpackungseinheit / Packing unit: 12 Stück / 12 pieces

Betriebsklasse / Class <b>aR</b> <b>gR</b>	<b>IEC 60 269-4</b> <b>VDE 0636-4</b>	<b>DIN EN 60269-4</b>
--	--	-----------------------

Bemessungs- spannung Rated Voltage	Artikel Nr. Article No	Größe Size	Bemessungsstrom ohne Kennmelder Rated Current without indicator	Bemessungsstrom mit Kennmelder Rated Current with indicator
V			A	A
DC 1500	90 081 10	20 x 127 mm	< 5	≥ 5

Bemessungs- spannung Rated Voltage	Artikel Nr. Article No	Größe Size	Bemessungsstrom mit Auslöser Rated Current with striker pin
V			A
DC 1500	90 086 10	20 x 127 mm	≥ 5

Bemessungsausschaltvermögen / Rated breaking capacity 30 kA

Bemessungsstrom Rated Current	Artikel Nr. Article No.	Gewicht Weight	Betriebsklasse Class	Schmelzintegral Pre-Arcing- I <sup>2</sup> t-Value	Ausschaltintegral Total I <sup>2</sup> t-Value	Leistungsabgabe Power Loss
A		kg / 1		A <sup>2</sup> s	A <sup>2</sup> s	W
2	90 081 10.2	0,36	aR	0,64	8	3,9
3,15	90 081 10.3,15	0,36	aR	2	16	4,1
5	90 081 10.5	0,36	gR	4,8	11	3,0
6	90 081 10.6	0,36	gR	3	17	3,0
8	90 081 10.8	0,36	gR	7	42	3,2
10	90 081 10.10	0,36	gR	13	75	3,4
12	90 081 10.12	0,36	gR	20	120	4,6
16	90 081 10.16	0,36	gR	52	300	5,7
20	90 081 10.20	0,36	gR	82	470	6,8
25	90 081 10.25	0,36	gR	118	670	8,1

Applikationskoeffizienten / Application coefficients (Weiterführende Informationen siehe Seite 13 / for more information see page 13)

a	A2	B1 max.	B2	Cf3
130	0,6	1,25	0,6	0,8



**DC 1500 V Ø 20 x 127 mm**

**Zeit/Strom-Kennlinien**  
Time-current characteristics

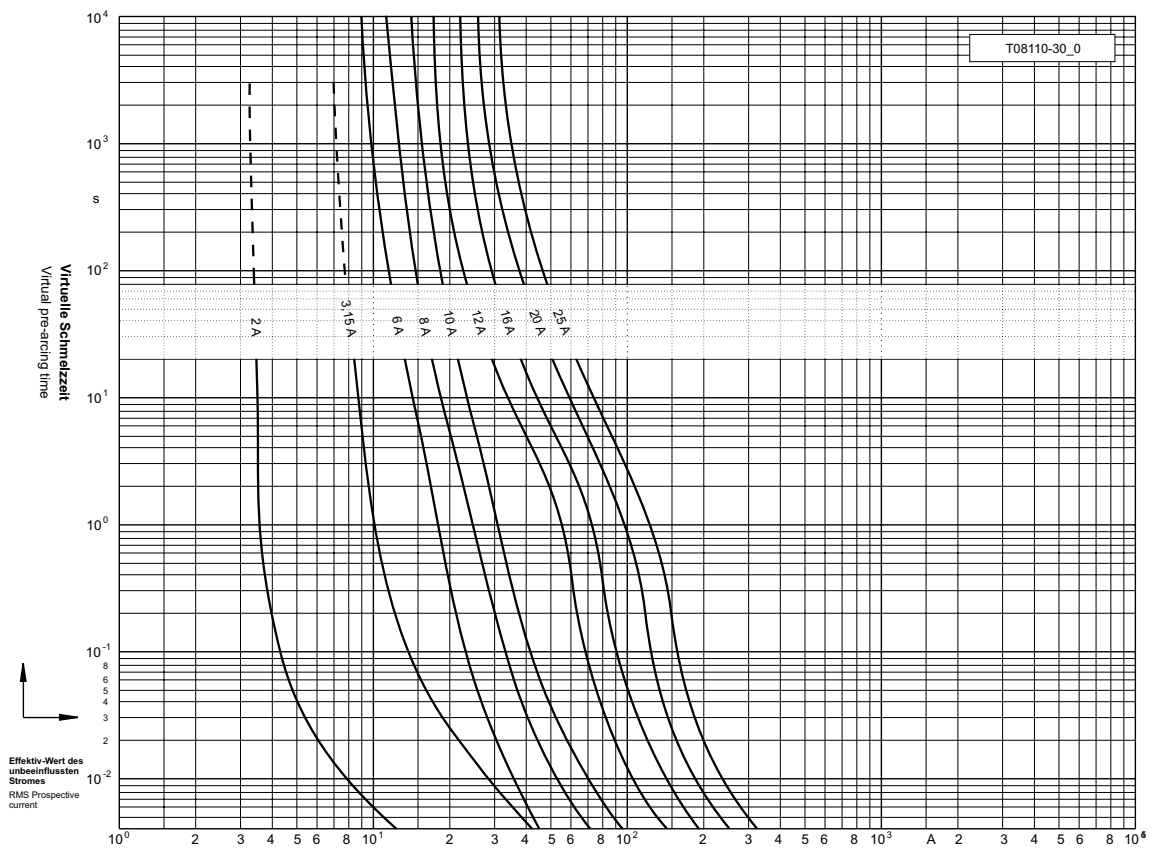
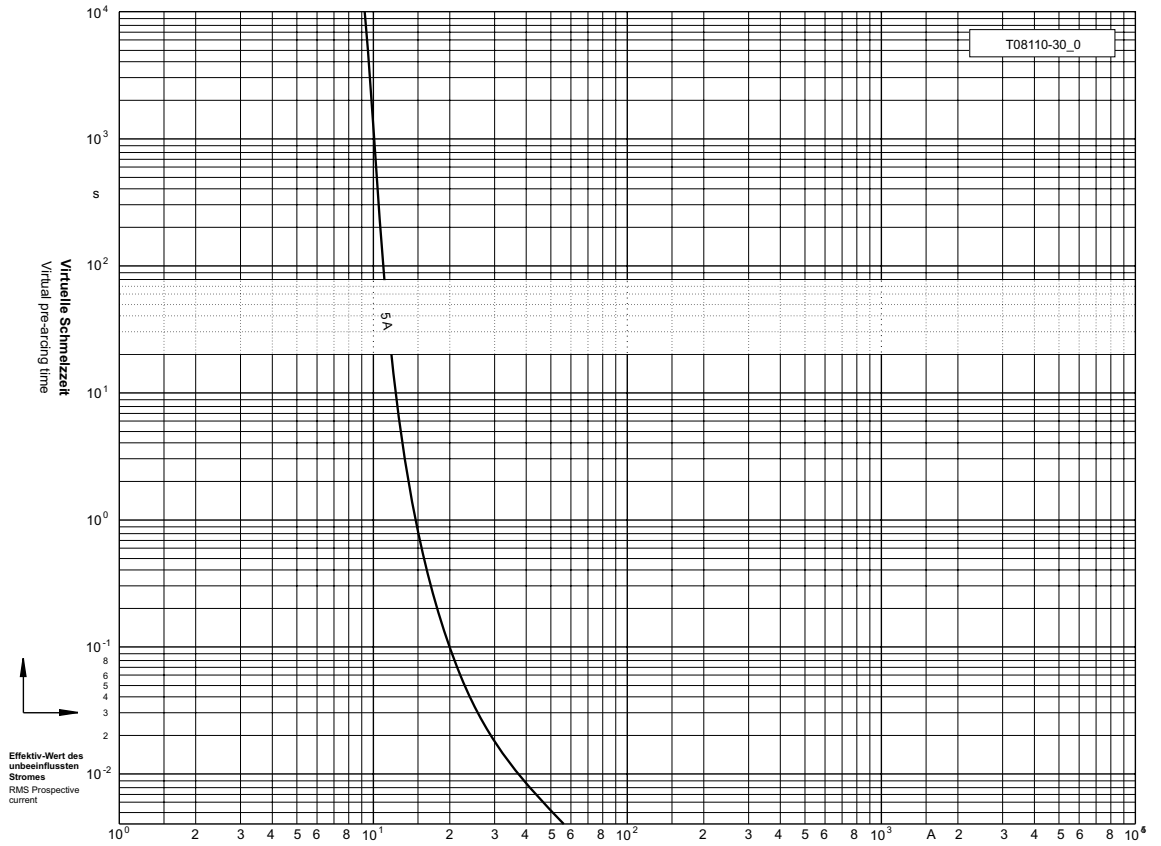

**DC 1500 V Ø 20 x 190 mm**

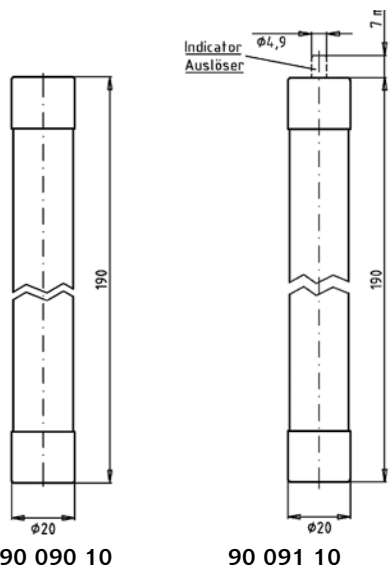

Verpackungseinheit / Packing unit: 6 Stück / 6 pieces

Betriebsklasse / Class <b>gR</b>	<b>IEC 60 077-5</b> <b>VDE 0115 Teil 460-5</b>	<b>UIC 550</b>
-------------------------------------	---	----------------

Bemessungs- spannung Rated Voltage	Artikel Nr. Article No	Größe Size	Bemessungs- strom Rated Current	Länge L Length L	Durchmesser D Diameter D
V			A	mm	mm
DC 1500	90 090 10	20 x 190	1-32	190	20
	90 091 10		1-32	190	20

Bemessungsausschaltvermögen / Rated breaking capacity 60 kA

Bemessungsstrom Rated Current	Artikel Nr. Article No.		Gewicht Weight	Schmelzintegral Pre-Arcing- I <sup>2</sup> t-Value	Ausschaltintegral Total I <sup>2</sup> t-Value @ DC 1500 V	Leistungsabgabe Power Loss
	Ohne Auslöser/ without striker	Mit Auslöser/ with striker				
A			kg / 1	A <sup>2</sup> s	A <sup>2</sup> s	W
1	90 090 10.1	90 091 10.1	0,11	0,2	1,3	2,8
2	90 090 10.2	90 091 10.2	0,11	0,9	5,3	4,1
3	90 090 10.3	90 091 10.3	0,11	2,6	16	4,5
4	90 090 10.4	90 091 10.4	0,11	7,3	45	5,6
6	90 090 10.6	90 091 10.6	0,11	7,4	44	3,1
8	90 090 10.8	90 091 10.8	0,11	13	80	4,1
10	90 090 10.10	90 091 10.10	0,11	30	180	4,4
12	90 090 10.12	90 091 10.12	0,11	53	320	4,7
16	90 090 10.16	90 091 10.16	0,11	90	550	6,2
20	90 090 10.20	90 091 10.20	0,11	150	900	7,6
25	90 090 10.25	90 091 10.25	0,11	240	1.400	8,1
32	90 090 10.32	90 091 10.32	0,11	600	3.600	9,7

Applikationskoeffizienten / Application coefficients (Weiterführende Informationen siehe Seite 13 / for more information see page 13)

a	A2	B1 max.	B2	Cf3
130	0,6	1,25	0,6	0,8

**DC 1500 V Ø 20 x 190 mm**

**Zeit/Strom-Kennlinien**  
Time-current characteristics

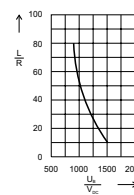
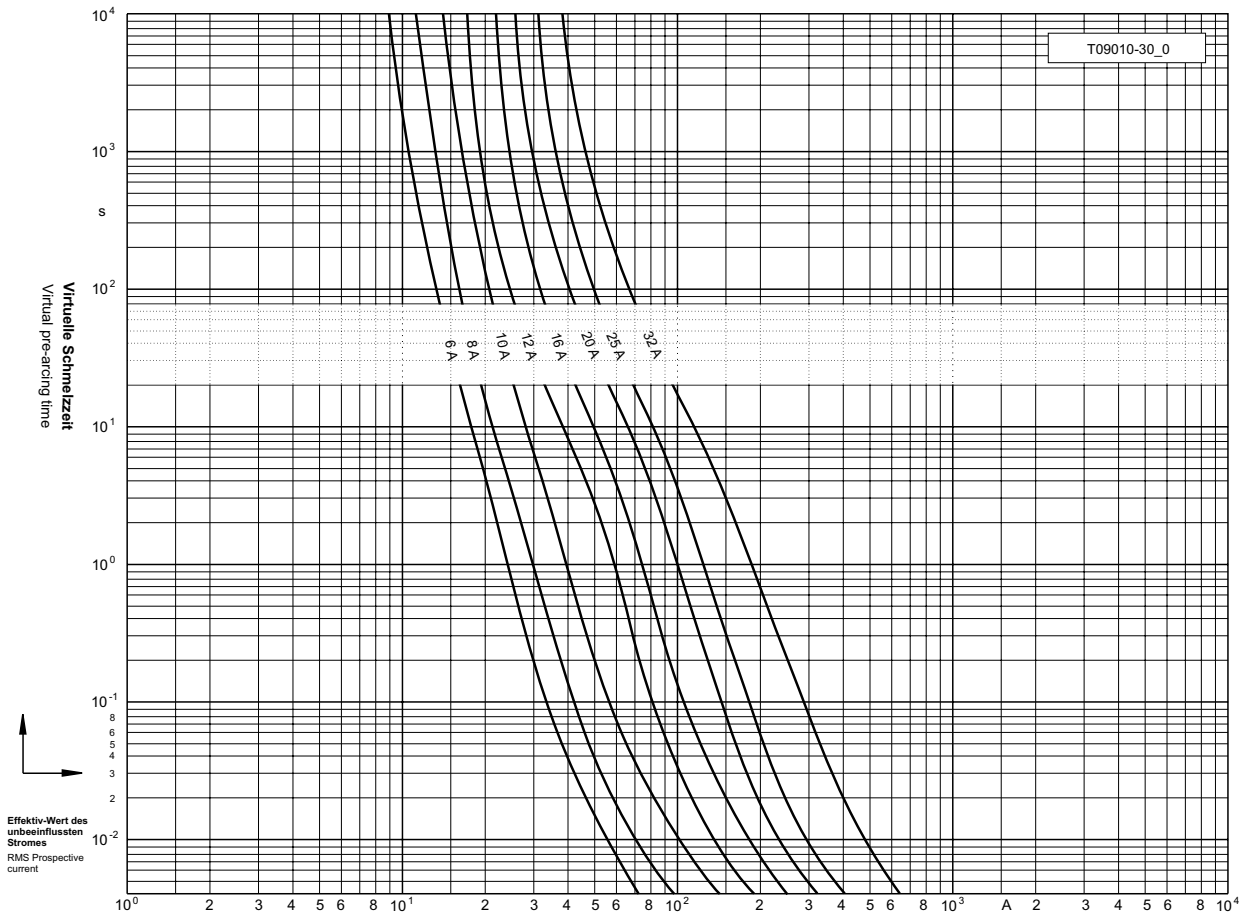

**Umrechnungsfaktor für die Bemessungsspannung bei diff. Zeitkonstanten**  
Correction factor for diff. time constant v.s. max. voltage

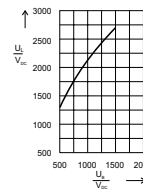

**Schaltspannungsdiagramm**  
Arc Voltage-Diagram

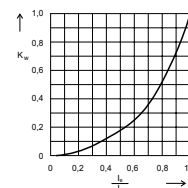

**Umrechnungsfaktor der Leistungsabgabe**  
Reduction factor for power Loss

**DC 1500 V Ø 36 x 190 mm**

Verpackungseinheit / Packing unit: 1 Stück / 1 pieces

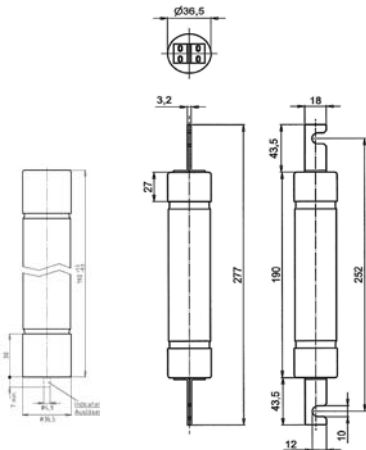

Betriebsklasse / Class <b>gR</b>	<b>in Anlehnung an / in compliance with: VDE 0636-1 und -4</b>
-------------------------------------	--

Bemessungs- spannung Rated Voltage	Artikel Nr. Article No	Größe Size	Bemessungs- strom Rated Current	Länge L Length L	Durchmesser D Diameter D
V			A	mm	mm
DC 1500	90 094 10	36 x 190	20-100	190	36,5
	90 095 10		20-100	190	36,5
	90 098 10		20-100	190	36,5

90 094 10  
90 095 10

90 098 10

Bemessungsausschaltvermögen / Rated breaking capacity 30 kA (L/R = 15ms)

Bemessungs- strom Rated Current	Artikel Nr. Article No.			Gewicht Weight	Schmelzintegral Pre-Arcing- I <sup>2</sup> t-Value	Ausschalt- integral Total I <sup>2</sup> t-Value	Leistungs- abgabe * Power Loss
	Ohne Auslöser/ without striker	Mit Auslöser/ with striker	Stichmaß 252 mm fixing center 252 mm				
A				kg / 1	A <sup>2</sup> s	@ DC 1500 V L/R=30 ms A <sup>2</sup> s	W
20	90 094 10.20	90 095 10.20	90 098 10.20	0,50/0,61	60	470	9
25	90 094 10.25	90 095 10.25	90 098 10.25	0,50/0,61	100	770	12
32	90 094 10.32	90 095 10.32	90 098 10.32	0,50/0,61	130	950	16
40	90 094 10.40	90 095 10.40	90 098 10.40	0,50/0,61	290	2.200	22
50	90 094 10.50	90 095 10.50	90 098 10.50	0,50/0,61	620	4.600	25
63	90 094 10.63	90 095 10.63	90 098 10.63	0,50/0,61	1.000	7.500	30
80	90 094 10.80	90 095 10.80	90 098 10.80	0,50/0,61	2.050	15.300	34
100	90 094 10.100	90 095 10.100	90 098 10.100	0,50/0,61	3.500	25.800	38

Applikationskoeffizienten / Application coefficients (Weiterführende Informationen siehe Seite 13 / for more information see page 13)

a	A2	B1 max.	B2	Cf3
130	0,6	1,25	0,6	0,8

**DC 1500 V Ø 36 x 190 mm**

Zeit/Strom-  
Kennlinien  
Time-current  
characteristics

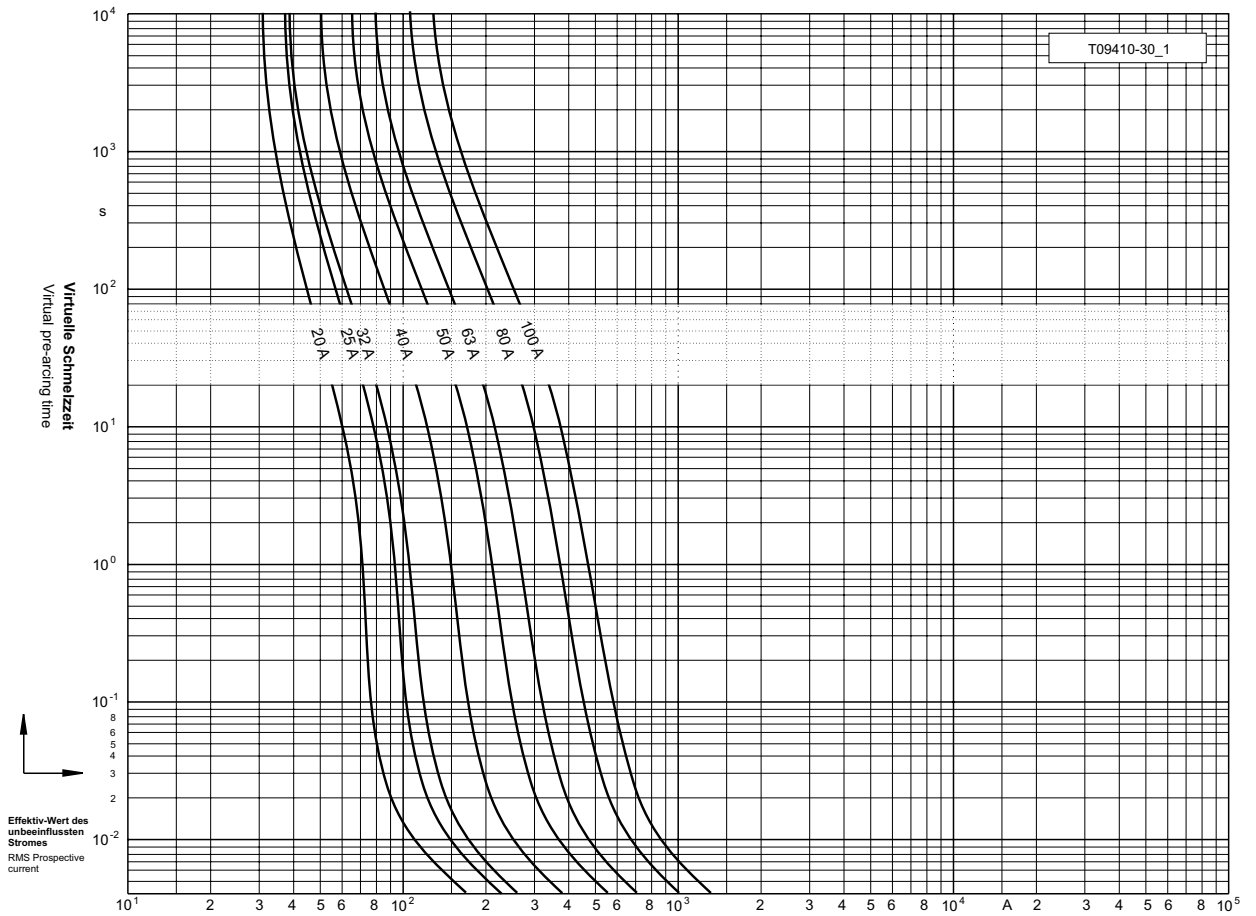

**DC 2000 V Ø 36 x 250 mm**

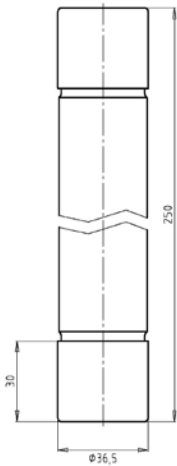

90 096 10

Verpackungseinheit / Packing unit: 1 Stück / 1 pieces

Betriebsklasse / Class <b>gR</b>	in Anlehnung an / in compliance with: <b>VDE 0636-1 und -4</b>
-------------------------------------	---

Bemessungs- spannung Rated Voltage	Artikel Nr. Article No	Größe Size	Bemessungs- strom Rated Current	Länge L Length L	Durchmesser D Diameter D
V			A	mm	mm
DC 2000	90 096 10	36 x 250	2-40	250	36,5

Bemessungsausschaltvermögen / Rated breaking capacity 30 kA (L/R = 20ms)

Bemessungsstrom Rated Current	Artikel Nr. Article No.	Gewicht Weight	Schmelzintegral Pre-Arcing- I <sup>2</sup> t-Value	Ausschaltintegral Total I <sup>2</sup> t-Value  @ DC 2000 V L/R=20 ms	Leistungsabgabe * Power Loss
A	Ohne Auslöser/ without striker	kg / 1	A <sup>2</sup> s	A <sup>2</sup> s	W
2	90 096 10.2	1,90	2,5	3,5	7
6	90 096 10.6	1,90	17	54	10
12	90 096 10.12	1,90	102	330	17
16	90 096 10.16	1,90	72	360	14
20	90 096 10.20	1,90	81	430	14
25	90 096 10.25	1,90	154	820	18
32	90 096 10.32	1,90	250	1.350	22
40	90 096 10.40	1,90	414	2.200	26

Applikationskoeffizienten / Application coefficients (Weiterführende Informationen siehe Seite 13 / for more information see page 13)

a	A2	B1 max.	B2	Cf3
130	0,6	1,25	0,6	0,8

**DC 2000 V Ø 36 x 250 mm**

**Zeit/Strom-  
Kennlinien**  
Time-current  
characteristics

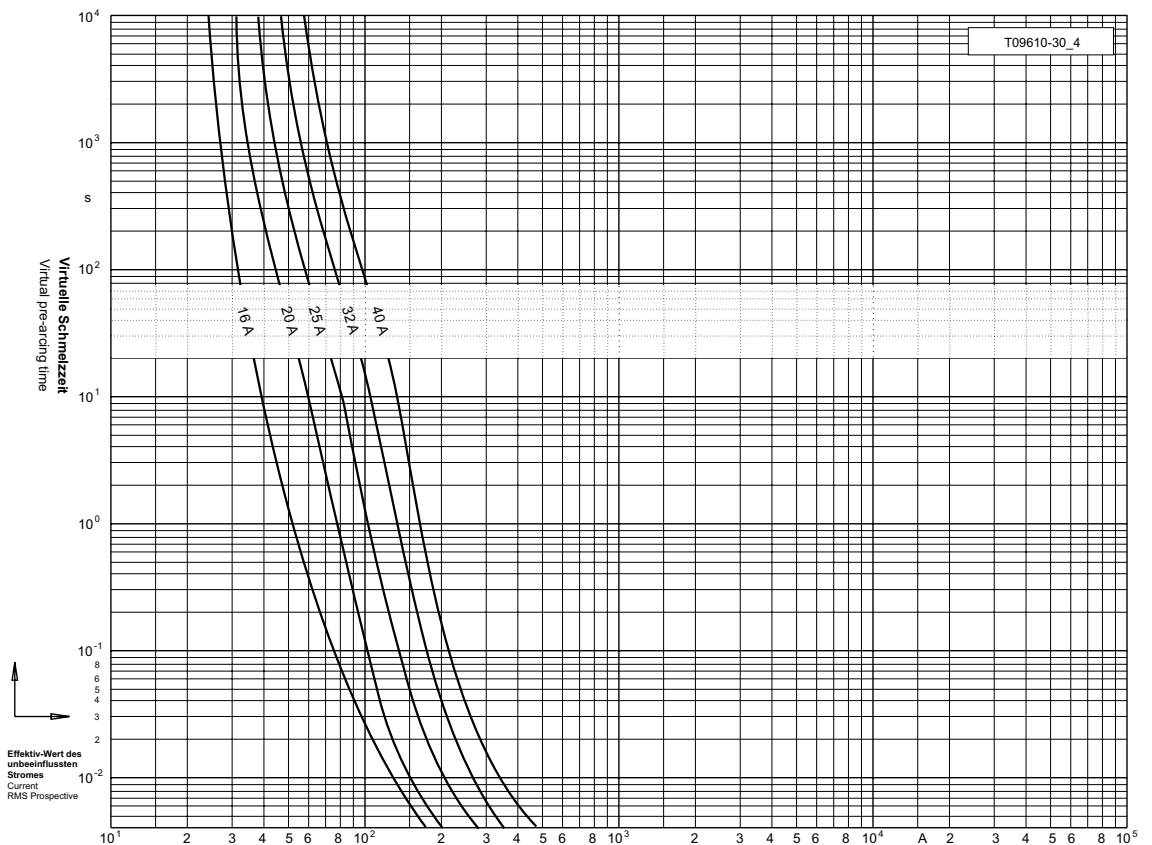
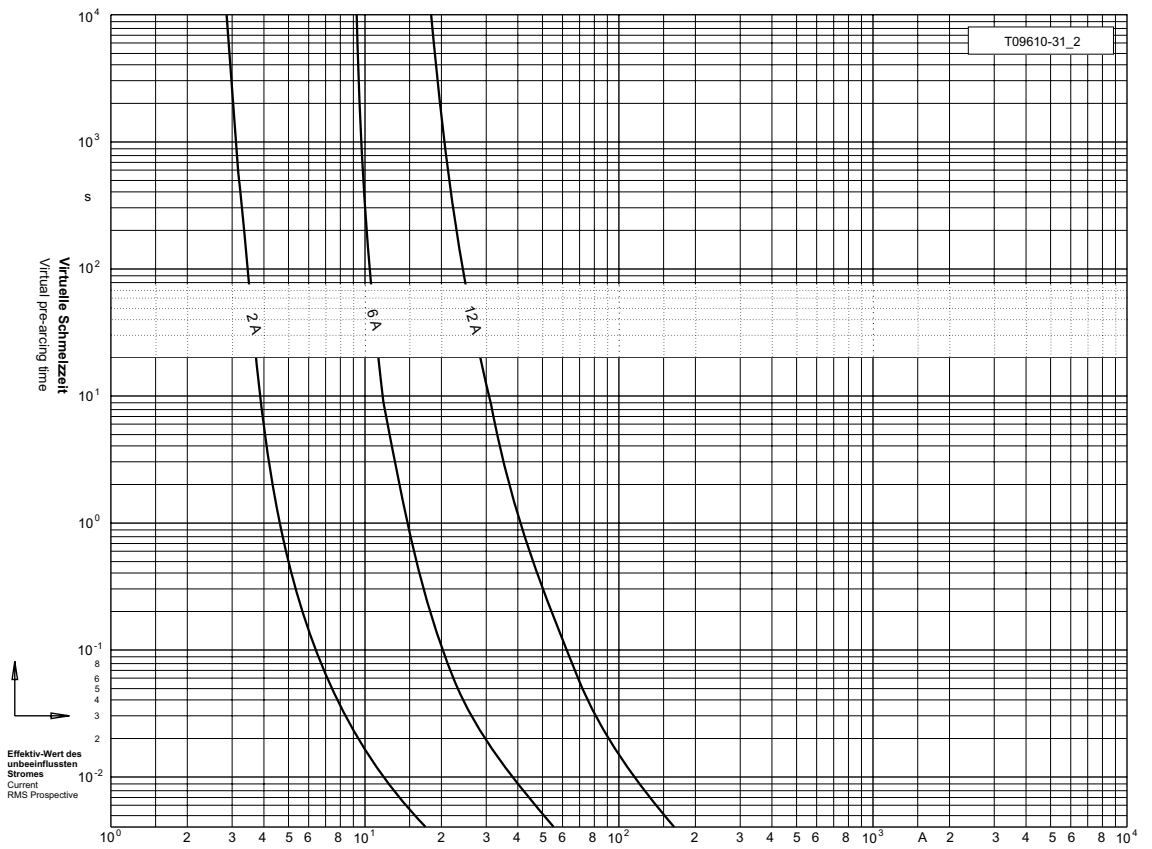

**DC 4000 V Ø 39,6 x 254 mm**

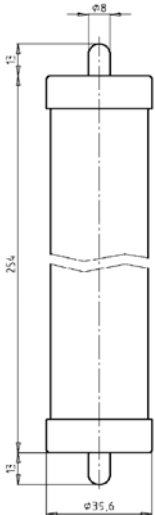

Verpackungseinheit / Packing unit: 1 Stück / 1 pieces

Betriebsklasse / Class <b>gR</b>	<b>IEC 60 077-5 UIC 550</b>
-------------------------------------	---------------------------------

Bemessungs- spannung Rated Voltage	Artikel Nr. Article No	Größe Size	Bemessungs- strom Rated Current	Länge L Length L	Durchmesser D Diameter D
V			A	mm	mm
DC 3600	90 100 10	39,6 x 254	2-20	254	39,6

Bemessungsausschaltvermögen / Rated breaking capacity **3,2 kA (L/R = 16ms)**  
**1,6 kA (L/R = 11ms)**

Bemessungsstrom Rated Current	Artikel Nr. Article No.	Gewicht Weight	Schaltspannung Switching Voltage	Schmelzintegral Pre-Arcing- I <sup>2</sup> t-Value	Ausschaltintegral Total I <sup>2</sup> t-Value	Leistungs- abgabe * Power Loss
A		kg / 1	kV	A <sup>2</sup> s	A <sup>2</sup> s	W
					@ DC 4000 V L/R=15mS	
2	90 100 10.2	0,78	15	2,5	3,5	9
3,15	90 100 10.3,15	0,78	15	4	8	13
3,9	90 100 10.3,9	0,78	15	8	13	24
5	90 100 10.5	0,78	15	15	21	18
6,3	90 100 10.6,3	0,78	15	24	41	22
8	90 100 10.8	0,78	10	27	110	21
12,5	90 100 10.12,5	0,78	10	68	220	40
16	90 100 10.16	0,78	10	72	360	23
20	90 100 10.20	0,78	10	120	600	27

Applikationskoeffizienten / Application coefficients (Weiterführende Informationen siehe Seite 13 / for more information see page 13)

a	A2	B1 max.	B2	Cf3
130	0,6	1,25	0,6	0,8



**DC 4000 V Ø 39,6 x 254 mm**

**Zeit/Strom-  
Kennlinien**  
Time-current  
characteristics

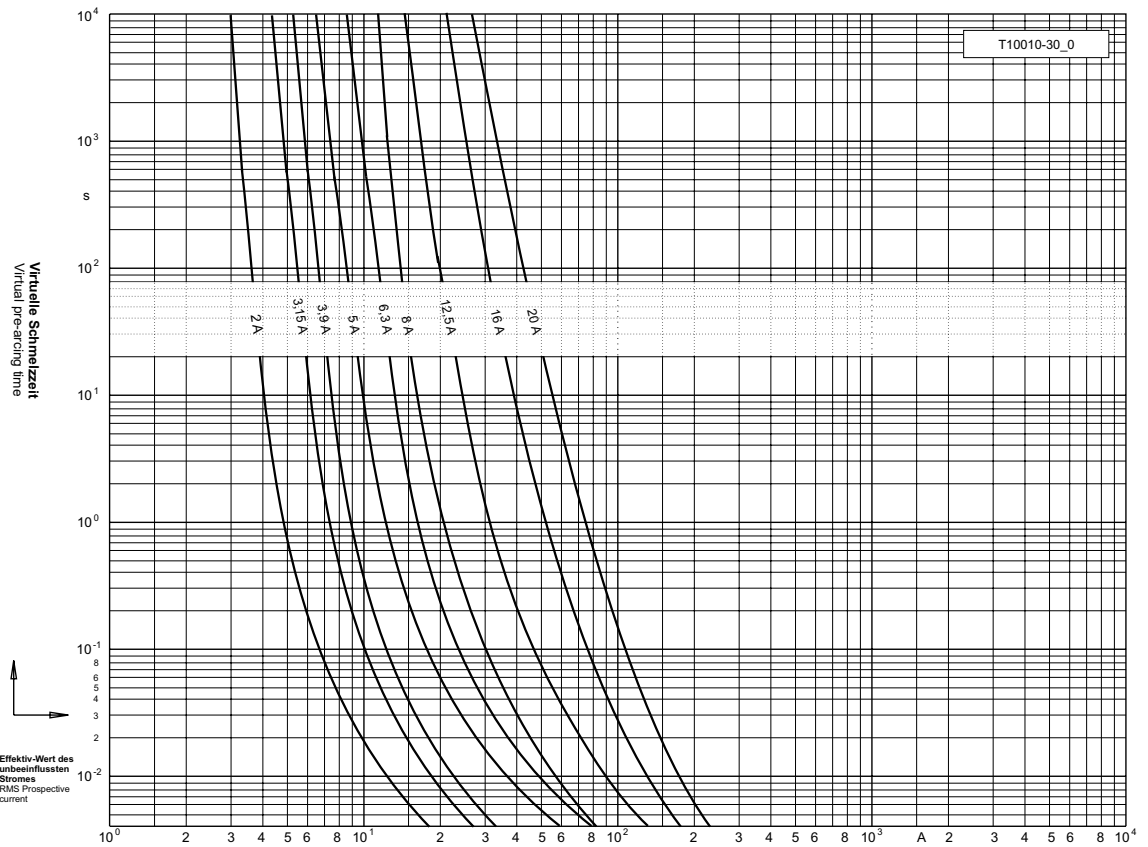

Ø 10

Clip für Direkt- und Leiterplattenmontage  
Clip for Direct- and PCB-mounting

58 063 16

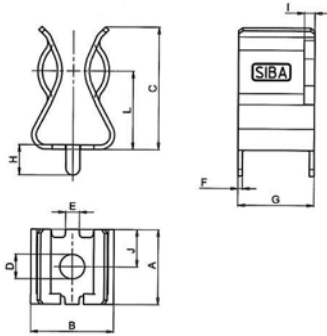

58 063 19

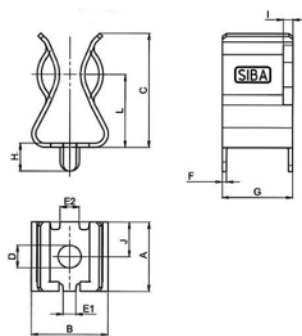

mit Verdrehungsschutz  
with twist protection

58 063 17

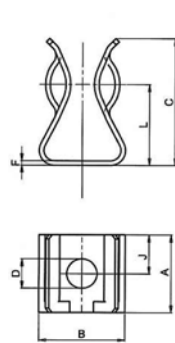

63 017 01

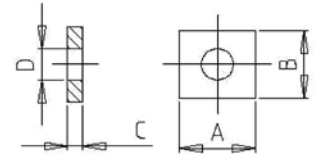

63 017 01.3

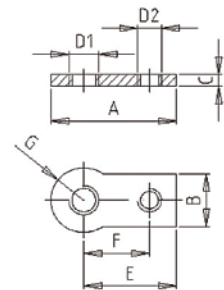

Verpackungseinheit / Packing unit:	100 Stück / 100 pieces	100 Stück / 100 pieces	100 Stück / 100 pieces	1000 Stück / 1000 pieces	1000 Stück / 1000 pieces
IEC 60269-2	Kontaktclip Fuse-Clip PCB Mountable <b>58 063 16</b>	Kontaktclip Fuse-Clip PCB Mountable <b>58 063 19</b>	Kontaktclip Fuse-Clip PCB Mountable <b>58 063 17</b>	Anschraubplatte Clamping Plate <b>63 017 01</b>	Anschlusslasche Terminal Link <b>61 017 01.3</b>
IEC 60269-3	<b>10 x 38 mm</b>				
IEC 60269-4	Bemessungsleistungsaufnahme 4 W / Rated Power Acceptance 4 W				
	Kupferlegierung CuSn, verzinkt / Copper alloy CuSn, tin-plated	Kupferlegierung CuSn, verzinkt / Copper alloy CuSn, tin-plated	Kupferlegierung CuSn, verzinkt / Copper alloy CuSn, tin-plated	Kupferlegierung CuSn, vernickelt / Copper alloy CuSn, nickel-plated	Kupferlegierung CuSn, versilbert / Copper alloy CuSn, silver-plated
A	11,0 mm	11,0 mm	11,0 mm	10,0 mm	21,0 mm
B	12,0 mm	12,0 mm	12,0 mm	9,0 mm	6,0 mm
C	18,0 mm	18,0 mm	18,0 mm	2,0 mm	2,0 mm
D	3,6 mm	3,6 mm	4,2 mm	4,2 mm	-
D1	-	-	-	-	M5
D2	-	-	-	-	M4
E	2,0 mm	-	-	-	15,5 mm
E1	-	2,0 mm	-	-	-
E2	-	3,0 mm	-	-	-
F	0,65 mm	0,65 mm	0,65 mm	-	11,0 mm
G	11,0 mm	11,0 mm	-	-	5,5 mm
H	4,45 mm	4,45 mm	-	-	-
I	1,5 mm	1,5 mm	1,5 mm	-	-
J	5,5 mm	5,5 mm	5,5 mm	-	-
K	-	-	-	-	-
L	11,5 mm	11,5 mm	11,5 mm	-	-
Gewicht/Weight kg/1	0,003	0,003	0,003	0,001	0,003

**Ø 14**

## Clip für Direkt- und Leiterplattenmontage Clip for Direct- and PCB-mounting

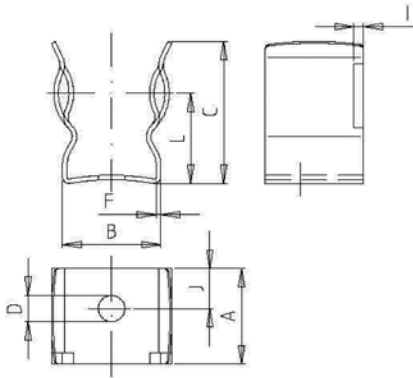
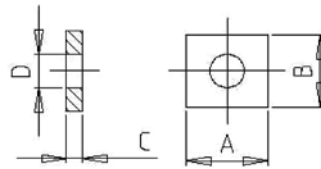
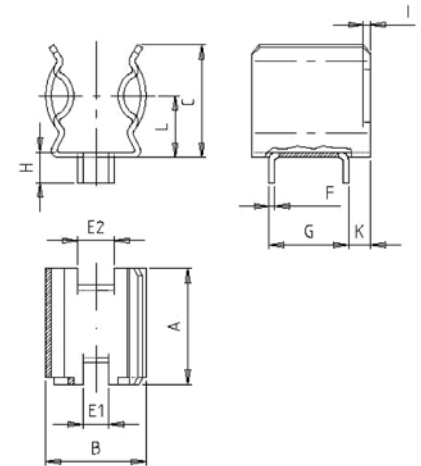
**61 001 01.2**

**63 017 01**

**58 058 06.**

Verpackungseinheit / Packing unit:	100 Stück / 100 pieces	1000 Stück / 1000 pieces	500 Stück / 500 pieces
IEC 60269-2	Anschraubclip Fuse-Clip Screw Mountable <b>61 001 01.2</b>	Anschraubplatte Clamping Plate <b>63 017 01</b>	Einlötlclip Fuse-Clip PCB Mountable <b>58 058 06</b>
IEC 60269-3	<b>14 x 51 mm</b>		
IEC 60269-4	Bemessungsleistungsaufnahme 6 W / Rated Power Acceptance 6 W		
	Kupferlegierung CuSn, vernickelt / Copper alloy CuSn, nickel-plated	Kupferlegierung CuSn, vernickelt / Copper alloy CuSn, nickel-plated	Kupferlegierung CuSn, verzinkt / Copper alloy CuSn, tin-plated
A	15,5 mm	10,0 mm	16,0 mm
B	15,5 mm	9,0 mm	12,0 mm
C	22,8 mm	2,0 mm	15,5 mm
D	4,2 mm	4,2 mm	-
E1	-	-	3,5 mm
E2	-	-	5,0 mm
F	0,7 mm	-	0,75 mm
G	-	-	10,7 mm
H	-	-	4,2 mm
I	1,5 mm	-	1,0 mm
J	6,5 mm	-	-
K	-	-	3,0 mm
L	14,5 mm	-	8,5 mm
Gewicht/Weight kg/1	0,006	0,001	0,004

Ø 20/22

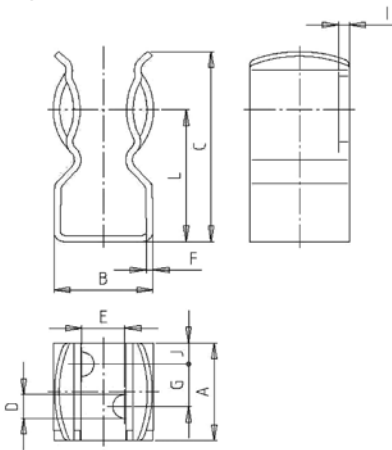
Clip für Direkt- und Leiterplattenmontage  
Clip for Direct- and PCB-mounting

61 002 01.3



63 002 01

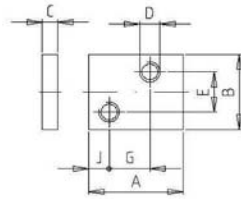

63 002 01.4

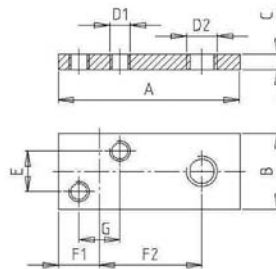

58 060 06

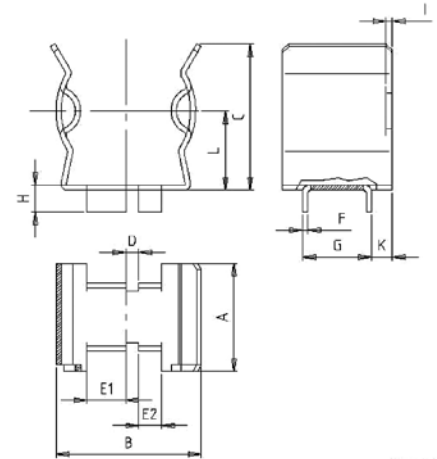

Verpackungseinheit / Packing unit:	100 Stück / 100 pieces	100 Stück / 100 pieces	100 Stück / 100 pieces	1000 Stück / 1000 pieces
IEC 60269-2	Anschraubclip Fuse-Clip Screw Mountable <b>61 002 01.3</b>	Anschraubplatte Clamping Plate <b>63 002 01</b>	Anschraublasche Terminal Link <b>61 002 01.4</b>	Einlötklip Fuse-Clip PCB Mountable <b>58 060 06</b>
IEC 60269-3	<b>20,6 x 127 mm / 22 x 58 mm</b>			
IEC 60269-4	Bemessungsleistungsaufnahme 6 W / Rated Power Acceptance 6 W			
	Kupferlegierung CuSn, vernickelt / Copper alloy CuSn, nickel-plated	Kupferlegierung CuSn, vernickelt / Copper alloy CuSn, nickel-plated	Kupferlegierung CuSn, vernickelt / Copper alloy CuSn, nickel-plated	Kupferlegierung CuSn, verzinnt / Copper alloy CuSn, tin-plated
A	18,5 mm	18,5 mm	35,5 mm	17,0 mm
B	18,4 mm	15,0 mm	15,0 mm	20,0 mm
C	36,0 mm	3,0 mm	3,0 mm	23,0 mm
D	4,5 mm	M4	-	2,0 mm
D1	-	-	M4	-
D2	-	-	M6	-
E	8,0 mm	8,0 mm	8,0 mm	-
E1	-	-	-	6,0 mm
E2	-	-	-	3,5 mm
F	1,2 mm	-	-	0,8 mm
F1	-	-	7,5 mm	-
F2	-	-	8,0 mm	-
G	8,0 mm	8,0 mm	8,0 mm	10,7 mm
H	-	-	-	4,2 mm
I	2,0 mm	-	-	1,0 mm
J	4,0 mm	4,0 mm	-	-
K	-	-	-	3,5 mm
L	25,0 mm	-	-	12,5 mm
Gewicht/Weight kg/1	0,020	0,010	0,012	0,008

Ø 27/36

Clip für Direkt- und Leiterplattenmontage  
Clip for Direct- and PCB-mounting

61 004 01.3

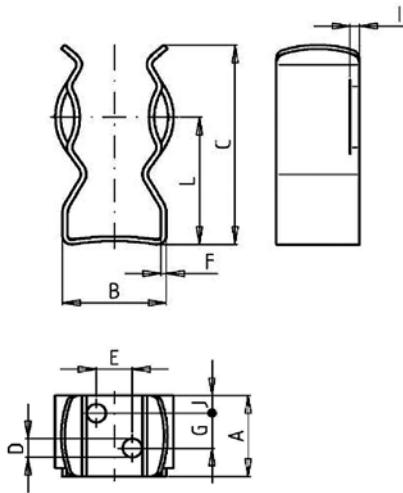

91 094 01.3

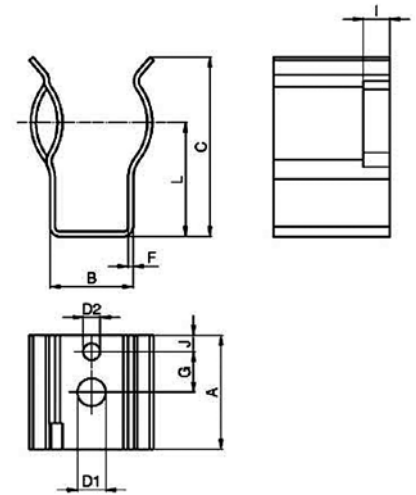

63 002 01

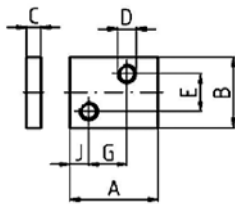

91 094 01.4

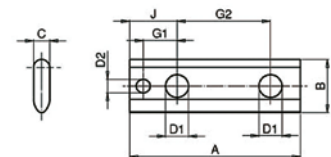

Verpackungseinheit / Packing unit:	100 Stück / 100 pieces	100 Stück / 100 pieces	100 Stück / 100 pieces	100 Stück / 100 pieces
IEC 60269-2	Anschraubclip Fuse-Clip Screw Mountable <b>61 004 01.3</b>	Anschraubplatte Clamping Plate <b>63 002 01</b>	Anschraubclip Fuse-Clip Screw Mountable <b>91 094 01.3</b>	Anschraub-/Kontaktplatte Clamping-/Contact-Plate <b>91 094 01.4</b>
IEC 60269-3	<b>27 x 60 mm / 27 x 140 mm / 36 x 127 mm / 36 x 190 mm / 36 x 250 mm</b>			
IEC 60269-4	Bemessungsleistungsaufnahme 6 W / Rated Power Acceptance 6 W			
	Kupferlegierung CuSn, vernickelt / Copper alloy CuSn, nickel-plated	Kupferlegierung CuSn, vernickelt / Copper alloy CuSn, nickel-plated	Kupferlegierung CuSn, vernickelt / Copper alloy CuSn, nickel-plated	Kupferlegierung CuSn, vernickelt / Copper alloy CuSn, nickel-plated
A	18,5 mm	18,5 mm	35,0 mm	63,0 mm
B	23,2 mm	15,0 mm	25,0 mm	20,0 mm
C	45,5 mm	3,0 mm	55,0 mm	6,0 mm
D	4,3 mm	M4	-	-
D1	-	-	8,5 mm	8,5 mm
D2	-	-	5,1 mm	5,1 mm
E	8,0 mm	8,0 mm	-	-
F	1,2 mm	-	1,5 mm	-
G	8,0 mm	8,0 mm	12,5 mm	-
G1	-	-	-	12,5 mm
G2	-	-	-	34,5 mm
I	2,0 mm	-	8,0 mm	-
J	4,0 mm	4,0 mm	5,0 mm	17,5 mm
L	29,0 mm	-	35,0 mm	-
Gewicht/Weight kg/1	0,018	0,010	0,018	0,133

690 V

URZ-U-Sicherungshalter  
URZ-U-Fuse-Holder

10 x 38 mm

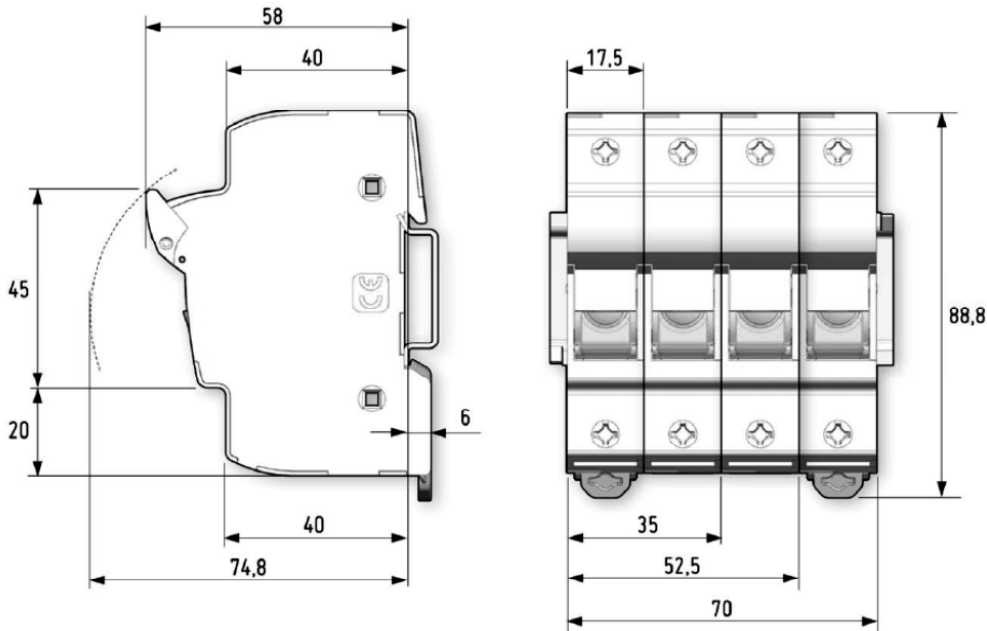
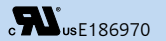

Type	Größe	ZS-Module	ZS-Module mit Meldeleuchte	Verpackungseinheit / Packing unit	Größe
Type	Size	ZS-Module	ZS-Module with indicator lamp	Stück / pieces	Size
	mm				kg / 1
1 pol.	10 x 38	51 063 05.1	51 063 05.1L	6	0,57
2 pol.		51 063 05.2	51 063 05.2L	3	1,14
3 pol.		51 063 05.3	51 063 05.3L	2	1,71
4 pol.		51 063 05.4	51 063 05.4L	1	2,28

IEC 60269-2  
IEC 60947-3  
VDE 0660-107  
NFC 61201 / NFC 63001  
UNE 20129 / UNE 21103

Bemessungsspannung Rated Voltage	Artikel Nr. Article No.	Bemessungsstrom Rated Current	Bemessungsleistungsaufnahme Rated Power Acceptance	Max. Anschlussquerschnitt Max. Connecting Cable	Max. Anzugsmoment Max. Tightening Torque	Gebrauchskategorie Utilization Category	Schutzklasse Degree of protection
V		A	W	mm <sup>2</sup>	Nm		
690	51 063 05.	32	4	25	2,5	690 V: AC-21B 750 V: DC-20B	IP-20

Anzahl der Pole No. of poles	Artikel Nr. Article No.		Artikel-Nr. / Article No. 51 063 05.
		Gehäuse / Body	Thermoplast. Polyester / Thermoplastic polyester
		Sicherungsträger / Handle	Thermoplast. Polyester / Thermoplastic polyester
	51 063 05.	Kontakte / Contacts	Kupfer, versilbert / Silver plating copper
1-3	1	Flammbarkeitsklasse „UL 94“ / Flammability "UL 94"	V2
4-6	0,8	Max. Gebrauchstemperatur / Max. Function Temperature	-50 ... +85 °C
7-9	0,7	Lagertemperatur / Storage	-50 ... +85 °C
> 10	0,6	Funktionsbereich Meldeleuchte / Rating of lightning indicator	AC / DC 120-750 V

**690 V** URZ-U-Sicherungshalter **14 x 51 mm**  
 URZ-U-Fuse-Holder

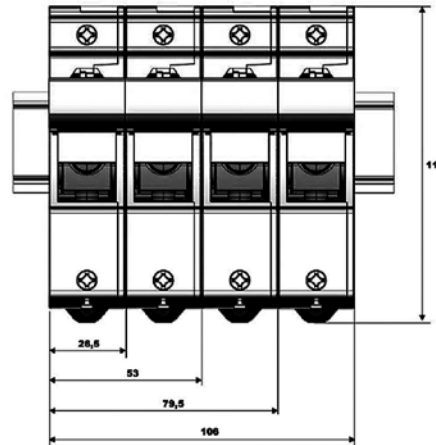
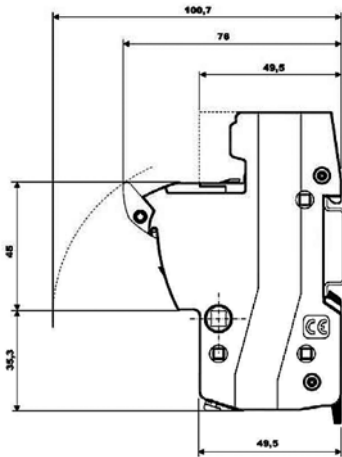
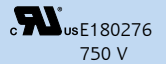

Type	Größe	ZS-Module	ZS-Module mit Mikroschalter	ZS-Module mit Meldeleuchte	Verpackungseinheit / Packing unit	Gewicht
Type	Size	ZS-Module	ZS-Module with micro switch	ZS-Module with lightning indicator	Stück / pieces	Weight
	mm					kg / 1
1 pol.	14 x 51	51 058 05.1	51 058 05.1S	51 058 05.1L	6	0,12
2 pol.		51 058 05.2	51 058 05.2S	51 058 05.2L	3	0,25
3 pol.		51 058 05.3	51 058 05.3S	51 058 05.3L	2	0,35

IEC 60269-1 / IEC 60269-2  
 IEC 60947-1 / IEC 60947-2  
 VDE 0636-1 / VDE 0636-2  
 VDE 0660-100 / VDE 0660-107  
 UL 4248-1 / CSA 22.2

Bemessungs- spannung Rated Voltage	Artikel Nr. Article No.	Bemessungs- strom Rated Current	Bemessungs- leistungsaufnahme Rated Power Acceptance	Max. Anschluss- querschnitt Max. Connecting Cable	Max. Anzugs- moment Max. Tightening Torque	Gebrauchskategorie Utilization Category	VSchutzklasse Degree of protection
V		A	W	mm <sup>2</sup>	Nm		
690 IEC 750 UL	51 058 05.1 51 058 05.2 51 058 05.3	50	6	1,5-35 solid wire 1,5-25 stranded wire	3	690 V: AC-21B 500 V: AC-22B	IP 20

Anzahl der Pole No. of poles	Artikel Nr. Article No.		Artikel-Nr. / Article No. 51 058 05.
		Gehäuse / Body	Thermoplast. Polyester / Thermoplastic polyester
		Sicherungsträger / Handle	Thermoplast. Polyester / Thermoplastic polyester
	51 058 05.	Kontakte / Contacts	Kupfer, versilbert / Silver plating copper
1-3	1	Flammbarkeitsklasse „UL 94“ / Flammability "UL 94"	V0
4-6	0,8	Max. Gebrauchstemperatur / Max. Function Temperature	-50 ... +85 °C
7-9	0,7	Lagertemperatur / Storage	-50 ... +85 °C
> 10	0,6	Funktionsbereich Meldeleuchte / Rating of lightning indicator	AC/DC 230-750 V

690 V

URZ-U-Sicherungshalter **22 x 58 mm**  
URZ-U-Fuse-Holder

**RU**  
c UsE186970  
750 V

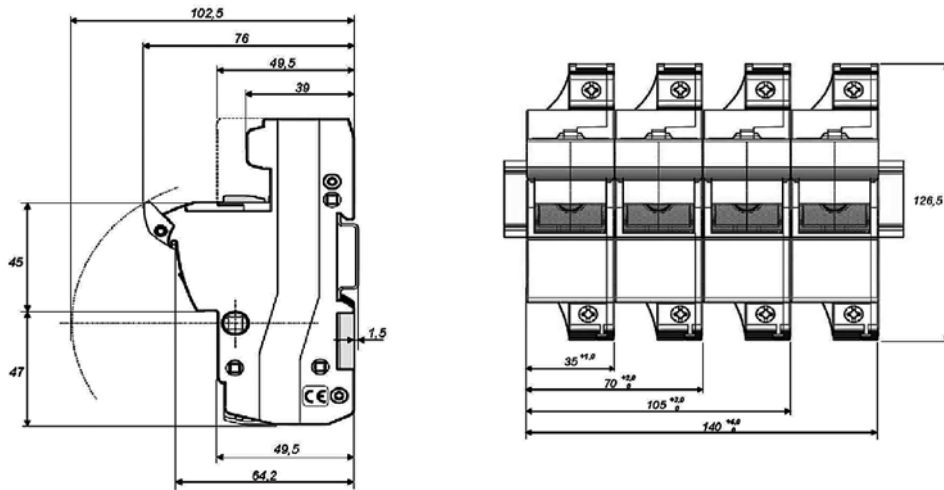

Type	Größe	ZS-Module	ZS-Module mit Mikroschalter	ZS-Module mit Meldeleuchte	Verpackungseinheit / Packing unit	Gewicht	IEC 60269-1 / IEC 60269-2 IEC 60947-1 / IEC 60947-2 VDE 0636-1 / VDE 0636-2 VDE 0660-100 / VDE 0660-107 UL 4248-1 / CSA 22.2
Type	Size	ZS-Module	ZS-Module with micro switch	ZS-Module with lightning indicator	Stück / pieces	Weight	
	mm					kg / 1	
1 pol.	22 x 58	51 060 05.1	51 060 05.1S	51 060 05.1L	6	0,18	
2 pol.		51 060 05.2	51 060 05.2S	51 060 05.2L	3	0,48	
3 pol.		51 060 05.3	51 060 05.3S	51 060 05.3L	2	0,53	

Bemessungsspannung Rated Voltage	Artikel Nr. Article No.	Bemessungsstrom Rated Current	Bemessungsleistungsaufnahme Rated Power Acceptance	Max. Anschlussquerschnitt Max. Connecting Cable	Max. Anzugsmoment Max. Tightening Torque	Gebrauchskategorie Utilization Category	VSchutzklasse Degree of protection
V		A	W	mm <sup>2</sup>	Nm		
690 IEC 750 UL	51 060 05.1 51 060 05.2 51 060 05.3	125 IEC 100 UL	12	1,5-50 solid wire 1,5-35 stranded wire	4	690 V: AC-21B	IP 20

**Nennstromkorrekturfaktor / Derating of rated current: K<sub>2s</sub>**

Anzahl der Pole No. of poles	Artikel Nr. Article No.		Artikel-Nr. / Article No. 51 060 05.
		Gehäuse / Body	Thermoplast. Polyester / Thermoplastic polyester
		Sicherungsträger / Handle	Thermoplast. Polyester / Thermoplastic polyester
	51 060 05.	Kontakte / Contacts	Kupfer, versilbert / Silver plating copper
1-3	1	Flammbarkeitsklasse „UL 94“ / Flammability "UL 94"	V0
4-6	0,8	Max. Gebrauchstemperatur / Max. Function Temperature	-50 ... +85 °C
7-9	0,7	Lagertemperatur / Storage	-50 ... +85 °C
> 10	0,6	Funktionsbereich Meldeleuchte / Rating of lightning indicator	AC/DC 230-750 V



**DC 1000 V** URZ-U-Sicherungshalter **10 x 38 mm**  
 URZ-U-Fuse-Holder

**UL** Listed  
 E341342  
 DC 1000 V  
 30 A

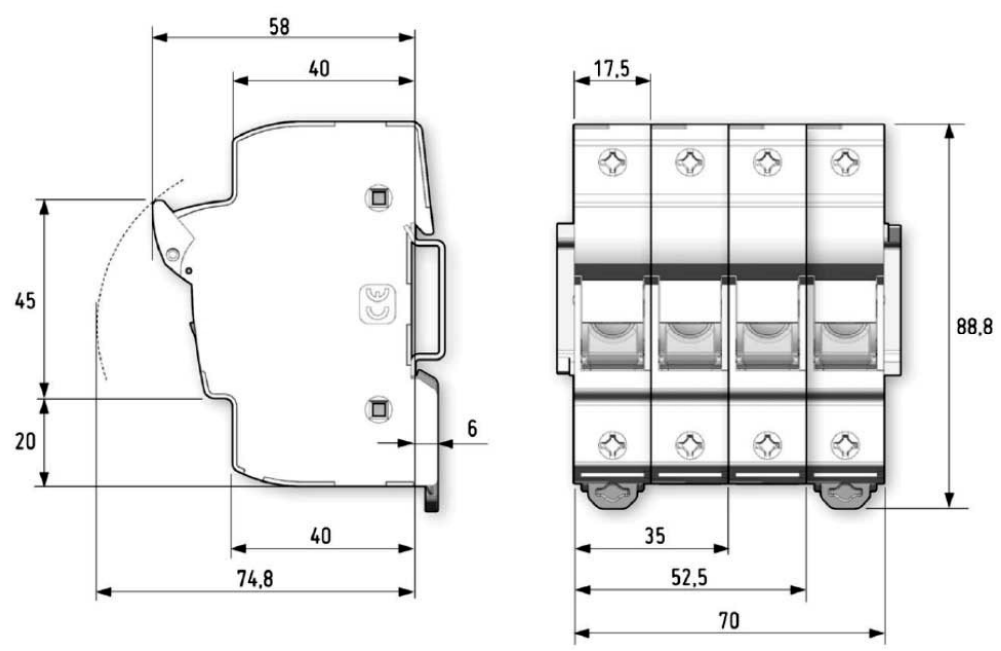

Type	Größe	ZS-Module	ZS-Module mit Meldeleuchte	Verpackungseinheit / Packing unit	Größe
Type	Size	ZS-Module	ZS-Module with indicator lamp		Size
	mm			Stück / pieces	kg / 1
1 pol.	10 x 38	51 063 05.1DC	51 063 05.1LDC	6	0,57
2 pol.		51 063 05.2DC	51 063 05.2LDC	3	1,14

**IEC 60269-2**

Bemessungsspannung	Artikel Nr.	Bemessungsstrom	Bemessungsleistungsaufnahme	Max. Anschlussquerschnitt	Max. Anzugsmoment	Gebrauchskategorie	Isolationsspannung	Schutzklasse
Rated Voltage	Article No.	Rated Current	Rated Power Acceptance	Max. Connecting Cable	Max. Tightening Torque	Utilization Category	Insulating Voltage	Degree of protection
V		A	W	mm <sup>2</sup>	Nm		kV	
DC 1000	51 063 05.1DC	30	4	0,75-16 solid wire 0,75-16 stranded wire	2,5	690V: AC-21B 1000V:DC-20B	8	IP-20
	51 063 05.2DC							

Anzahl der Pole	Artikel Nr.	
No. of poles	Article No.	
	51 063 05.	Artikel-Nr. / Article No. 51 063 05...DC
		Gehäuse / Body Thermoplast. Polyester / Thermoplastic polyester
		Sicherungsträger / Handle Thermoplast. Polyester / Thermoplastic polyester
		Kontakte / Contacts Kupfer, versilbert / Silver plating copper
		Flammbarkeitsklasse „UL 94“ / Flammability "UL 94" V0
1-3	1	Max. Gebrauchstemperatur / Max. Function Temperature -50 ... +85 °C
4-6	0,8	
7-9	0,7	Bemerkungen / Remarks Lastfrei schalten / not to open under load
> 10	0,6	Zuleitung oben / supply side on top only
		Funktionsbereich Meldeleuchte / Rating of lightning indicator AC/DC 350-1000 V

**DC 1000 V**

URZ-U-Sicherungshalter  
URZ-U-Fuse-Holder

**14 x 51 mm**

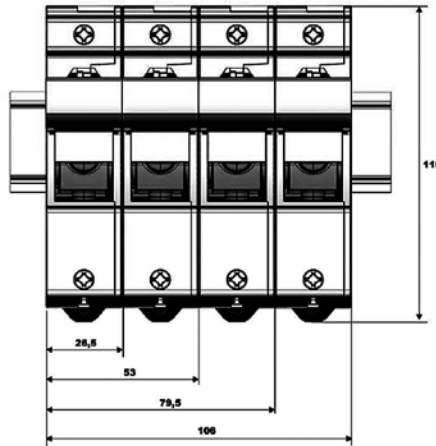
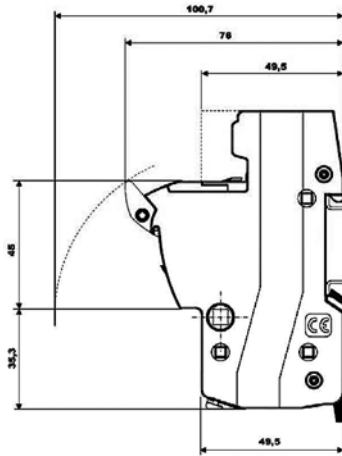

Type	Größe	ZS-Module	ZS-Module mit Anzeiger	Verpackungseinheit / Packing unit	Gewicht
Type	Size	ZS-Module	ZS-Module with indicator	Stück / pieces	Weight
	mm				kg / 1
1 pol.	14 x 51	51 058 05.1DC	51 058 05.1LDC	6	0,12
2 pol.		51 058 05.2DC	51 058 05.2LDC	3	0,23

IEC 60269-1 / IEC 60269-2  
IEC 60947-1 / IEC 60947-3  
UL 4248-1  
CSA 22.2

Bemessungs- spannung Rated Voltage	Artikel Nr. Article No.	Bemessungs- strom Rated Current	Bemessungs- leistungsaufnahme Rated Power Ac- ceptance	Max. Anschluss- querschnitt Max. Connecting Cable	Max. Anzugs- moment Max. Tightening Torque	Isolationsspannung Insulating Voltage	Schutzklasse Degree of protection
V		A	W	mm <sup>2</sup>	Nm	kV	
DC 1000	51 058 05.1DC	50	6	1,5-35 solid wire 1,5-25 stranded wire	3	8	IP-20

Anzahl der Pole No. of poles	Artikel Nr. Article No.		Artikel-Nr. / Article No. 51 058 05...DC
		Gehäuse / Body	Thermoplast. Polyester / Thermoplastic polyester
		Sicherungsträger / Handle	Thermoplast. Polyester / Thermoplastic polyester
	51 058 05.	Kontakte / Contacts	Kupfer, versilbert / Silver plating copper
1-4	1	Flammbarkeitsklasse „UL 94“ / Flammability “UL 94”	V0
5-6	0,8	Max. Gebrauchstemperatur / Max. Function Temperature	-50 ... +85 °C
7-9	0,7	Funktionsbereich Anzeiger / Rating of indicator	350 - 1000 V DC
> 10	0,6	Bemerkungen / Remarks	Lastfrei schalten / not to open under load

**DC 1500 V** Sicherungshalter **10/14 x 85 mm**  
Fuse-base

Verpackungseinheit / Packing unit: 10 Stück / 10 pieces

Bemessungsspannung Rated Voltage	Artikel Nr. Article No	Gewicht Weight	Bemessungsstrom Rated Current	Max. Leistungsaufnahme Rated Power Acceptance	Max. Anzugsdrehmoment (Unterteil) Max. Fuse base Torque	Standard
V		kg / 1	A	W	Nm	Standard
DC 1500/AC 1000	51 238 05	0,20	32	6	2,5	IEC 60269-1

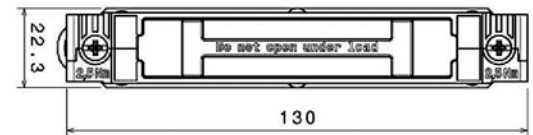
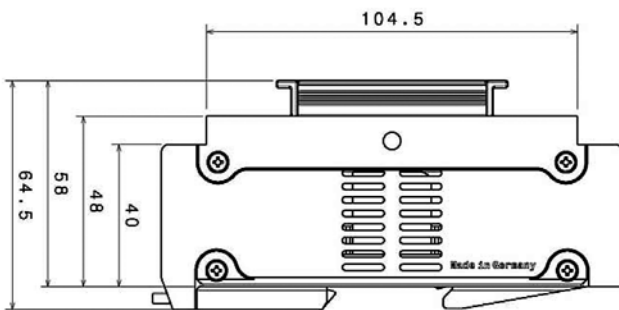

**DC 1500 V** URZ-Sicherungstrenner **20 x 127 mm**  
URZ-Fuse-disconnector **20 x 127 mm**

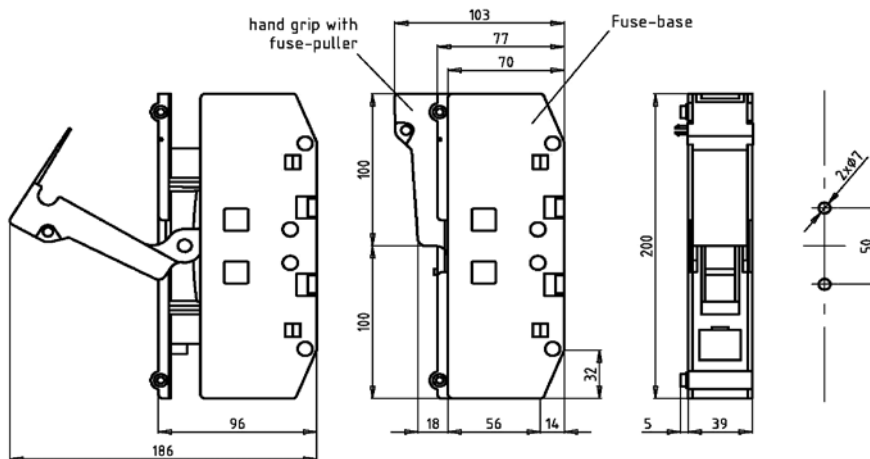

**IEC 60947-3**  
**AC 20 B, DC 20 B**

Verpackungseinheit / Packing unit: 1 Stück / 1 pieces

Bemessungsspannung Rated Voltage	Artikel Nr. Article No.	Gewicht Weight	Bemessungsstrom Rated Current	Max. Leistungsaufnahme Rated Power Acceptance	Max. Anschlussquerschnitt Max. Connecting Cable	Max. Anzugsmoment Max. Tightening Torque
V		kg / 1	A	W	mm <sup>2</sup>	Nm
1500	91 080 01.	0,50	63	15	50	10

**DC 1500 V**

**Sicherungsunterteile für URT-Sicherungseinsätze**  
**Fuse-base for URT Fuse-links**

**36 x 190 mm**

Verpackungseinheit / Packing unit: 1 Stück / 1 pieces

Bemessungsspannung	Artikel Nr.	Größe	Gewicht	Bemessungsstrom	Max. Leistungsaufnahme	Anschlußbolzen	Max. Anzugsdrehmoment (Anschlußbolzen)	Max. Anzugsdrehmoment (Unterteil)	Kontaktplatte
Rated Voltage	Article No	Size	Weight	Rated Current	Rated Power Acceptance	Connection bolts	Max. Nut Torque	Max. Fuse base Torque	Contact plate
V		mm	kg / 1	A	W		Nm	Nm	
DC 1500	91 094 01	36 x 190	1,22	100		M 8	22	20	Kupfer, versilbert copper, silver plated

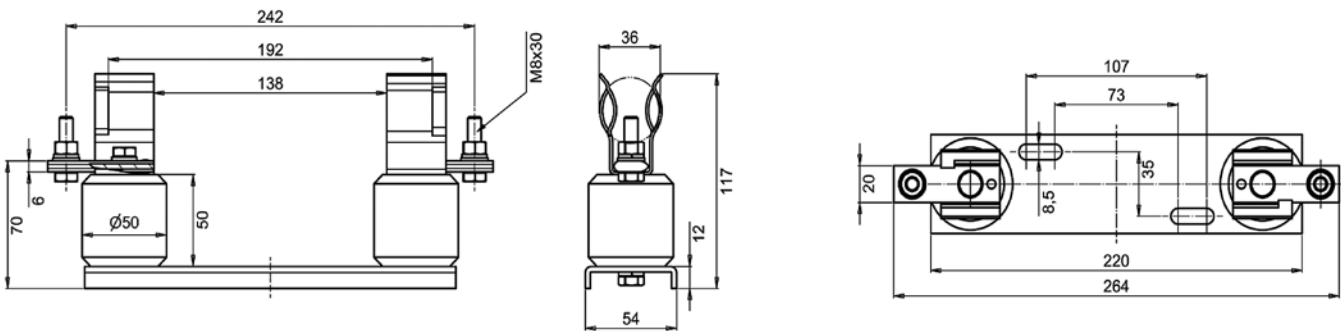

**DC 2000 V**

**Sicherungsunterteil**  
**Fuse-base**

**36 x 250 mm**

Verpackungseinheit / Packing unit: 1 Stück / 1 pieces

Bemessungsspannung	Artikel Nr.	Größe	Gewicht	Bemessungsstrom	Max. Leistungsaufnahme	Anschlußbolzen	Max. Anzugsdrehmoment (Anschlußbolzen)	Max. Anzugsdrehmoment (Unterteil)	Kontaktplatte
Rated Voltage	Article No	Size	Weight	Rated Current	Rated Power Acceptance	Connection bolts	Max. Nut Torque	Max. Fuse base Torque	Contact plate
V		mm	kg / 1	A	W		Nm	Nm	
DC 2000	91 096 01	36 x 250	1,028	40		M 8	22	20	Kupfer, versilbert copper, silver plated

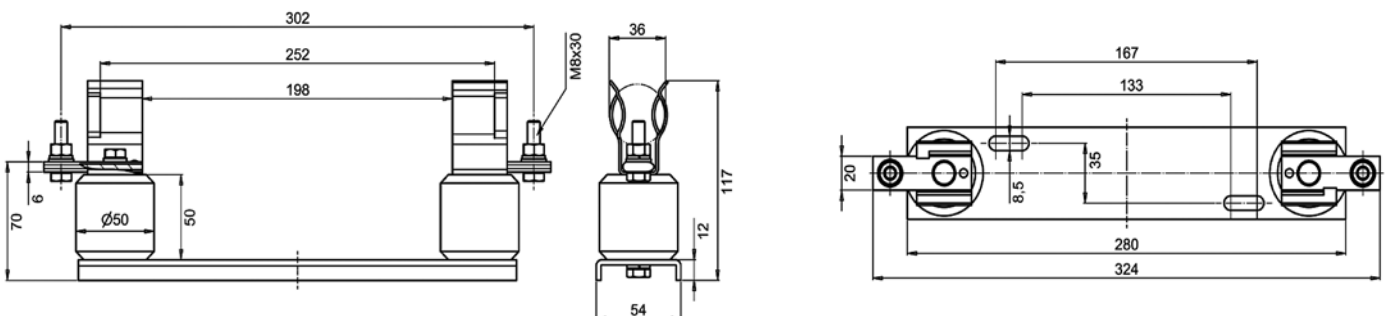



## Artikel-Verzeichnis / Article-Index

Artikel Article	Seite Page	Artikel Article	Seite Page	Artikel Article	Seite Page	Artikel Article	Seite Page
10 002 07	50	20 273 34	174	20 625 32	184	20 763 31	238
10 005 07	50	20 274 34	176	20 626 32	194	20 763 32	236
10 005 34	52	20 275 34	202	20 627 31	194	20 764 32	236
10 007 07	50	20 276 34	204	20 628 32	196	20 766 32	232
10 007 34	52	20 277 34	206	20 629 31	196	20 770 32	252
10 009 07	50	20 282 04	16	20 630 32	208	20 771 32	252
10 010 07	50	20 282 20	24	20 631 32	208	20 773 31	254
10 027 07	48	20 282 34	20	20 632 32	208	20 773 32	254
10 027 34	46	20 292 20	38	20 633 32	210	20 774 32	254
10 028 07	48	20 373 04	88	20 634 32	210	20 776 32	248
10 028 34	46	20 384 04	106	20 635 32	210	20 778 32	256
10 029 07	48	20 404 04	110	20 636 32	222	20 780 32	268
10 029 34	46	20 404 20	110	20 637 31	224	20 781 32	268
20 000 04	74	20 407 04	108	20 638 32	222	20 781 52	272
20 001 04	74	20 412 04	18	20 639 31	224	20 783 32	270
20 002 04	76	20 412 20	28	20 660 32	162	20 784 32	270
20 003 04	78	20 412 29	36	20 661 32	162	20 786 32	264
20 004 04	82	20 412 34	20	20 663 31	160	20 786 52	266
20 005 04	86	20 441 04	80	20 664 32	164	20 788 32	274
20 007 04	74	20 442 04	84	20 666 32	158	20 791 52	280
20 009 04	78	20 477 20	90	20 670 32	190	21 001 01.	124
20 010 04	82	20 477 34	92	20 671 32	190	21 001 03.	125
20 011 04	86	20 556 04	112	20 673 31	188	21 001 10.	126
20 028 20	118	20 556 20	114	20 674 32	192	21 001 13.	124
20 028 28	120	20 556 32	112	20 676 32	186	21 002 04.	127
20 028 29	120	20 558 04	16	20 678 32	198	21 003 01.	128
20 031 20	116	20 558 20	24	20 680 32	218	21 003 01.26	128
20 031 28	122	20 558 34	20	20 681 32	218	21 003 03.	129
20 031 29	122	20 559 20	26	20 681 52	214	21 003 03.30	128
20 034 28	306	20 559 22	26	20 683 31	216	21 003 04.	128
20 034 29	306	20 560 20	34	20 684 32	216/218	21 004 01.	130
20 189 04	18	20 561 20	30	20 686 32	212	21 004 01.26	130
20 189 20	28	20 561 22	30	20 688 32	226	21 004 03.	131
20 189 28	36	20 562 20	30	20 695 32	228	21 004 04.	130
20 189 29	36	20 563 20	32	20 713 32	230	21 005 01.	132
20 189 34	20	20 563 22	32	20 714 32	230	21 005 01.26	132
20 209 20	90	20 566 20	22	20 715 32	230	21 028 01.	133
20 209 34	92	20 610 32	150	20 718 32	240	21 028 28	138
20 211 20	94	20 611 32	152	20 719 31	242	21 031 01	134
20 211 34	96	20 612 32	152	20 723 32	244	21 031 28	137
20 212 20	98	20 613 32	154	20 724 32	246	21 189 01	40
20 212 34	100	20 614 32	156	20 725 32	246	21 189 08	40
20 213 20	102	20 615 32	156	20 728 32	250	21 189 11	40
20 213 34	104	20 616 32	166	20 729 31	250	21 189 28	42
20 252 34	142	20 617 31	166	20 733 32	258	21 190 28	42
20 253 34	170	20 618 32	168	20 734 32	260	21 313 01.	344
20 254 20	220	20 619 31	168	20 735 32	260	21 313 02.	344
20 254 34	200	20 620 32	178	20 735 52	262	21 323 01.	345
20 269 34	144	20 621 32	180	20 738 32	276	21 323 02.	345
20 270 34	146	20 622 32	180	20 739 31	276	21 556 01	135
20 271 34	148	20 623 32	182	20 760 32	234	24 031 01	134
20 272 34	172	20 624 32	184	20 761 32	234	25 001 01	124

## Artikel-Verzeichnis / Article-Index

Artikel Article	Seite Page	Artikel Article	Seite Page	Artikel Article	Seite Page	Artikel Article	Seite Page
25 001 03.2	124	50 181 06	368	60 033 05	358	90 220 27	332
25 003 01	128	50 190 06	384	60 034 34	360	90 220 28	332
25 004 01	130	50 191 06	384	60 064 34	360	90 221 20	318
25 005 01	132	50 192 06	384	60 075 34	360	90 221 21	318
28 001 04	346	50 193 20	366	61 001 01.2	433	90 221 25	328
28 002 01	43/138	50 194 20	366	61 002 01.3	434	90 221 26	328
28 002 02	43/138	50 196 20	378	61 004 01.3	435	90 222 25	316
28 002 03	44/139	50 197 20	378	61 017 01.3	432	90 222 26	316
28 002 04	44/139	50 199 06	398	63 002 01	434	90 223 25	308
28 003 10	347	50 201 06	388	63 002 01.4	434	90 223 26	308
28 003 11	347	50 202 06	388	63 017 01	432	90 230 27	332
28 003 12	347	50 204 26	400	70 007 40	352	90 231 20	318
28 003 20	349	50 205 26	400	70 065 84	354	90 235 20	330
28 003 21	349	50 210 06	396	70 125 40	356	90 300 20	286
28 003 22	349	50 215 06	392	70 172 40	394	90 300 21	286
28 004 10	348	50 215 26	402	90 077 10	408	90 310 20	290
28 004 11	348	50 215 28	404	90 078 10	406	90 310 21	290
28 004 12	348	50 216 06	392	90 079 10	382	90 320 20	292
28 004 20	350	50 216 26	402	90 080 10	410	90 320 21	292
28 004 21	350	50 216 28	404	90 081 10	422	90 320 25	282
28 004 22	350	50 217 06	392	90 082 10	410	90 320 26	282
28 011 04	346	50 217 26	402	90 083 10	314	90 330 20	300
50 053 06	58	50 217 28	404	90 086 10	422	90 330 21	300
50 054 06	60	50 218 26	402	90 090 10	424	90 350 20	288
50 058 06	362	50 218 28	404	90 091 10	424	90 350 21	288
50 059 06	362	50 225 26	380	90 092 10	412	90 360 20	294
50 060 06	364	50 226 26	380	90 093 10	412	90 360 21	294
50 061 06	364	50 227 26	380	90 094 10	426	90 370 20	296
50 071 06	62	50 235 26	414	90 095 10	426	90 370 21	296
50 073 06	66	50 235 28	416	90 096 10	428	90 370 25	284
50 074 06	68	50 237 26	414	90 098 10	426	90 370 26	284
50 075 06	70	50 237 28	416	90 100 10	430	90 378 21	298
50 076 06	56	50 238 26	414	90 200 25	340	90 380 20	302
50 077 06	64	50 238 28	416	90 200 26	340	90 380 21	302
50 118 06	386	50 239 26	414	90 201 20	322	90 388 20	304
50 120 06	390	50 239 28	416	90 201 21	322	90 421 18	278
50 124 06	370	50 245 26	420	90 201 25	324	90 510 06	334
50 124 34	372	50 247 26	420	90 201 26	324	90 511 06	334
50 126 06	370	50 255 06	418	90 202 25	320	91 080 01	441
50 126 34	372	50 256 06.1	418	90 202 26	320	91 094 01	442
50 129 06	370	51 058 05	437	90 203 25	310	91 094 01.3	435
50 129 34	372	51 058 05.1DC	440	90 203 26	310	91 094 01.4	435
50 140 06	374	51 060 05	438	90 210 25	342	91 096 01	442
50 140 34	376	51 063 04	436	90 210 26	342		
50 142 06	374	51 063 05	437	90 211 25	326		
50 142 34	376	51 238 05	441	90 211 26	326		
50 145 06	374	51 063 05	436	90 213 25	312		
50 145 34	376	58 058 06	433	90 213 26	312		
50 146 34	376	58 060 06	434	90 220 06	336		
50 170 20	366	58 063 16	432	90 220 20	330		
50 179 06	368	58 063 17	432	90 220 25	338		
50 180 06	368	58 063 19	432	90 220 26	338		

## Hauptsitz

**SIBA GmbH**  
Borker Straße 20-22  
D-44534 Lünen  
Postfach 1940  
D-44509 Lünen  
Tel.: +49-2306-7001-0  
Fax: +49-2306-7001-10  
info@siba.de  
www.siba.de

## SIBA Unit Miniature Fuses

Tel.: +49-2306-7001-290  
Fax: +49-2306-7001-990  
elu@siba.de

## Germany

### SIBA Vertriebsbüro Freiberg

Untergasse 12  
D-09599 Freiberg  
Tel.: +49-3731-202283  
Fax: +49-3731-202462  
alexander.kolbe@siba.de

### SIBA Vertriebsbüro Rhein/Ruhr

Espelweg 25  
D-58730 Fröndenberg  
Tel.: +49-2373-1753141  
Fax: +49-2373-1753142  
joerg.mattusch@siba.de

### SIBA Vertriebsbüro Süd-West

Germersheimer Str. 101a  
D-67360 Lingenfeld  
Tel.: +49-6344-937510  
Fax: +49-6344-937511  
erwin.leuthner@siba.de

### SIBA Vertriebsbüro Kassel

Sieberweg 20  
D-34225 Baunatal  
Tel.: +49-5601-965300  
Fax: +49-5601-965301  
achim.fischer@siba.de



## International

### SIBA Sicherungen- und Schalterbau Ges.m.b.H & Co. KG (Austria)

Ortsstraße 18 · A-2331 Vösendorf bei Wien  
Tel.: +43-1-6994053 und 6992592  
Fax: +43-1-699405316 und 699259216  
info.siba@aon.at  
www.siba-sicherungen.at

### SIBA GmbH Beijing

Rep. Office (China)  
Room 207A, Building B, He Qiao Mansion No. 8  
Guanghua Road, Chaoyang District,  
Beijing 100026  
Tel.: +86-10-65817776  
Fax: +86-10-65812979  
siba\_china@sibafuse.cn  
www.sibafuse.cn

### SIBA Písek s.r.o. (Czech Rep.)

U Vodárny 1506 · 397 01 Písek  
Tel.: +420-38-2265746  
Fax: +420-38-2265746  
sibacz@iol.cz · www.siba-pojistky.cz

### SIBA Sikringer Danmark A/S (Denmark)

ehemals/former Ole Andersen A/S  
Lunikvej 24 B · DK-2670 Greve  
Tel.: +45-86828175 · Fax: +45-86814565  
info@sikringer.dk · www.siba-sikringer.dk

### SIBA Nederland B.V. (Netherlands)

Van Gentstraat 16  
NL-5612 KM Eindhoven  
Tel.: +31-40-2467071  
Fax: +31-40-2439916  
info@sibafuses.nl · www.siba-zekeringen.nl

### SIBA Polska sp. z o.o. (Poland)

ul. Grzybowa 5G  
05-092 Łomianki, Dąbrowa Leśna  
Tel.: +48-22-8321477  
Fax: +48-22-8339118  
siba@sibafuses.pl  
www.siba-bezpieczniki.pl

### SIBA GmbH (Russia)

Shosse Entusiastov 21, of. 407  
111123 Moskva  
Tel.: +7-495-9871413  
Fax: +7-495-9871774  
info@siba-predohraniteli.ru  
www.siba-predohraniteli.ru

### SIBA Fuses SA PTY. LTD. (South Africa)

P.O. Box 34261 · Jeppestown 2043  
Tel.: +27-11334-6560 / 4  
Fax: +27-11334-7140  
sibafuses@universe.co.za  
www.siba-fuses.co.za

### SIBA Far East Pte. LTD.

(South East Asia)  
24 Sin Ming Lane #07-105 Midview City  
Singapore 573970  
Tel.: +65-66599449  
Fax: +65-62341428  
info@sibafuse.com.sg  
www.sibafuse.com.sg

### SIBA (UK) LTD. (United Kingdom)

19 Duke Street  
Loughborough LE11 1ED  
Tel.: +44-1509-269719  
Fax: +44-1509-236024  
siba.uk@btconnect.com  
www.siba-fuses.co.uk

### SIBA Fuses LLC (United States of America)

29 Fairfield Place  
West Caldwell, NJ 07006  
Tel.: +1-973575-7422 (973-575-SIBA)  
Fax: +1-973575-5858  
info@sibafuses.com  
www.siba-fuses.us

Weitere Vertriebspartner weltweit:  
www.siba.de / www.siba-fuses.com



Sicherungen | Fuses

Sie profitieren. Mit Sicherheit.  
Our Protection. Your Benefit.