

IEC Appliance Inlet C14 with Fuseholder 1- or 2-pole

V-Lock



Screw-On Version



Pick & Place Version

**Description**

- Panel Mount: Sandwich/rear-side
- 2 Functions: Appliance Inlet Protection class I, with or without Fuseholder for fuse-links 5 x 20 mm on the rear-side 1- or 2-pole
- For PCB mounting
- Pick and place version

Approvals

- VDE Certificate Number: 40024857
- UL File Number: E93617, E96454
- CSA File Number: 38456

Characteristics

- PCB mount with snap-in or screw-on feet
- Suitable for automatic PCB assembling
- All single elements are already wired
- Fuseholder on the inside of the equipment prevents accidental use of incorrect fuse-links by the user
- With or without rear-side insulation cover
- Blister tray as optional packaging variant
- Suitable for use in equipment according to IEC 60950

Other versions on request

- Ground terminal with quick-connect terminal 6,3 x 0,8 mm
- Ground terminal with solder terminal
- For protection class II

Weblinks

[pdf-datasheet](#), [html-datasheet](#), [General Product Information](#), [Approvals](#), [CE declaration of conformity](#), [RoHS](#), [CHINA-RoHS](#), [Mating Connectors](#), [e-Shop](#), [SCHURTER-Stock-Check](#), [Distributor-Stock-Check](#), [CAD-Drawings](#), [Accessories](#), [Mounting instruction](#), [Detailed request for product](#)

Newly available variants corresponding to V-Lock mating cordset. The connector is equipped with a notch intended for use with the latching cordset. The cord latching system prevents against accidental removal of the cordset.

Technical Data

Ratings IEC	10A / 250VAC; 50Hz	Appliance Inlet	C14 acc. to IEC 60320, UL 498, CSA C22.2 no. 42 (for cold conditions) pin-temperature 70 °C, 10A, Protection Class I
Ratings UL/CSA	10A / 250VAC; 60Hz	Fuseholder	optional, 1 or 2 pole, Shocksafe category PC2 acc. to IEC 60127-6, for fuse-links 5 x 20mm
Dielectric Strength	> 3 kVAC between L-N > 4 kVAC between L/N-PE (1 min/50Hz)	Rated Power Acceptance @ Ta 23 °C	5 x 20: 3.15W (1 pole)/ 2.5W (2-pole) per pole
Allowable Operation Temp.	-25 °C to 70 °C	Power Acceptance @ Ta > 23 °C	Admissible power acceptance at higher ambient temperature see derating curves
Degree of Protection	from front side IP 40 acc. to IEC 60529		
Protection Class	Suitable for appliances with protection class I acc. to IEC 61140		
Terminal	For PCB mounting		
Panel Thickness s	Snap-in: 1.5/2/2.5/3 mm		
Material: Housing	Thermoplastic, black, UL 94V-0		

Dimensions

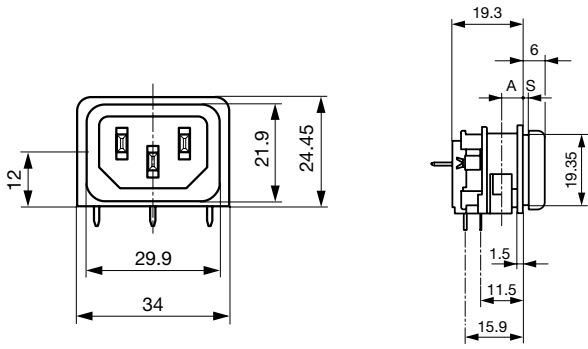

A = 6 mm for standard versions
 A = 5 mm for pick and place versions
 S = 0 mm for mounting from rear-side

with insulation cover

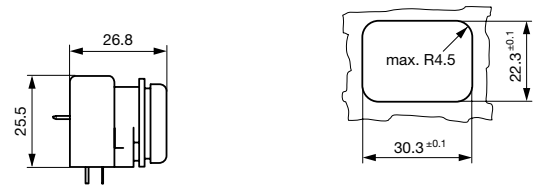

for mounting from rear-side

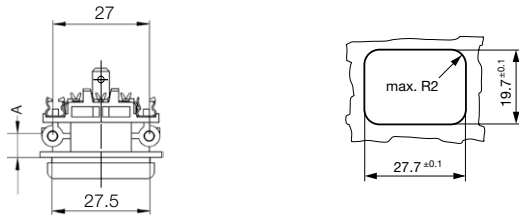

A = 6 mm for standard versions
 A = 5 mm for pick and place versions

for sandwich mounting

Drilling diagrams

without fuseholder

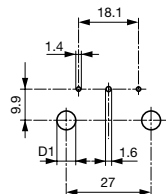

D1 for snap-in mounting = 6 ± 0.05
 D1 for self-tapping screw = 3.6 ± 0.1

with 1-pole fuseholder

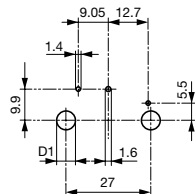

D1 for snap-in mounting = 6 ± 0.05
 D1 for self-tapping screw = 3.6 ± 0.1

with 2-pole fuseholder

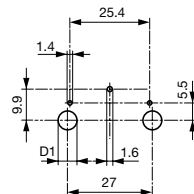

D1 for snap-in mounting = 6 ± 0.05
 D1 for self-tapping screw = 3.6 ± 0.1

Pick and Place versions
 without / with 1-pole or
 2-pole fuseholder

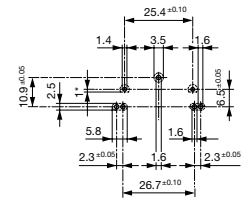

1* only for protection class II

Derating Curves

1-pole

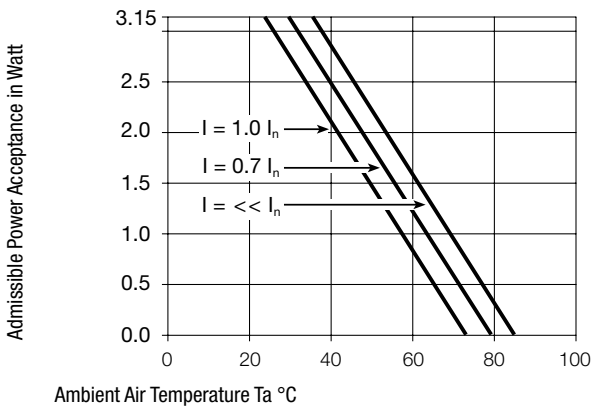

2-pole

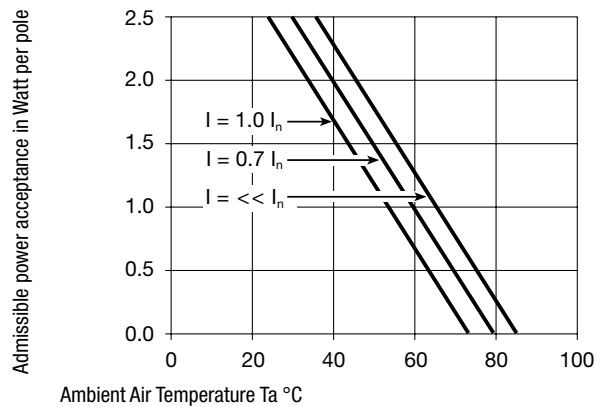

Variants

Mounting side	Panel mounting	Panel Thickness s [mm]	Fuseholder	Ground terminal 4.8 x 0.8 mm	Ground terminal direction	Packaging	Order Number
Sandwich	Screw	1.5	-	●	angled to pin axis	-	GSF1.0002.31
Sandwich	Screw	1.5	-	●	straight	-	GSF1.0001.31
Sandwich	Screw	2	-	●	angled to pin axis	-	GSF1.0002.41
Sandwich	Screw	2	-	●	straight	-	GSF1.0001.41
Sandwich	Screw	2.5	-	●	angled to pin axis	-	GSF1.0002.51
Sandwich	Screw	2.5	-	●	straight	-	GSF1.0001.51
Sandwich	Screw	3	-	●	angled to pin axis	-	GSF1.0002.61
Sandwich	Screw	3	-	●	straight	-	GSF1.0001.61
Sandwich	Screw	1.5	1-pole	●	angled to pin axis	-	GSF1.1002.31
Sandwich	Screw	1.5	1-pole	●	straight	-	GSF1.1001.31
Sandwich	Screw	2	1-pole	●	angled to pin axis	-	GSF1.1002.41
Sandwich	Screw	2	1-pole	●	straight	-	GSF1.1001.41
Sandwich	Screw	2.5	1-pole	●	angled to pin axis	-	GSF1.1002.51
Sandwich	Screw	2.5	1-pole	●	straight	-	GSF1.1001.51
Sandwich	Screw	3	1-pole	●	angled to pin axis	-	GSF1.1002.61
Sandwich	Screw	3	1-pole	●	straight	-	GSF1.1001.61
Sandwich	Screw	1.5	2-pole	●	angled to pin axis	-	GSF1.2002.31
Sandwich	Screw	1.5	2-pole	●	straight	-	GSF1.2001.31
Sandwich	Screw	2	2-pole	●	angled to pin axis	-	GSF1.2002.41
Sandwich	Screw	2	2-pole	●	straight	-	GSF1.2001.41
Sandwich	Screw	2.5	2-pole	●	angled to pin axis	-	GSF1.2002.51
Sandwich	Screw	2.5	2-pole	●	straight	-	GSF1.2001.51
Sandwich	Screw	3	2-pole	●	angled to pin axis	-	GSF1.2002.61
Sandwich	Screw	3	2-pole	●	straight	-	GSF1.2001.61
Sandwich	Snap-in	1.5	-	●	angled to pin axis	-	GSF1.0202.31
Sandwich	Snap-in	1.5	-	●	straight	-	GSF1.0201.31
Sandwich	Snap-in	2	-	●	angled to pin axis	-	GSF1.0202.41
Sandwich	Snap-in	2	-	●	straight	-	GSF1.0201.41
Sandwich	Snap-in	2.5	-	●	angled to pin axis	-	GSF1.0202.51
Sandwich	Snap-in	2.5	-	●	straight	-	GSF1.0201.51
Sandwich	Snap-in	3	-	●	angled to pin axis	-	GSF1.0202.61
Sandwich	Snap-in	3	-	●	straight	-	GSF1.0201.61
Sandwich	Snap-in	1.5	1-pole	●	angled to pin axis	-	GSF1.1202.31
Sandwich	Snap-in	1.5	1-pole	●	straight	-	GSF1.1201.31
Sandwich	Snap-in	2	1-pole	●	angled to pin axis	-	GSF1.1202.41
Sandwich	Snap-in	2	1-pole	●	straight	-	GSF1.1201.41
Sandwich	Snap-in	2.5	1-pole	●	angled to pin axis	-	GSF1.1202.51
Sandwich	Snap-in	2.5	1-pole	●	straight	-	GSF1.1201.51
Sandwich	Snap-in	3	1-pole	●	angled to pin axis	-	GSF1.1202.61
Sandwich	Snap-in	3	1-pole	●	straight	-	GSF1.1201.61
Sandwich	Snap-in	1.5	2-pole	●	angled to pin axis	-	GSF1.2202.31
Sandwich	Snap-in	1.5	2-pole	●	straight	-	GSF1.2201.31
Sandwich	Snap-in	2	2-pole	●	angled to pin axis	-	GSF1.2202.41
Sandwich	Snap-in	2	2-pole	●	straight	-	GSF1.2201.41
Sandwich	Snap-in	2.5	2-pole	●	angled to pin axis	-	GSF1.2202.51
Sandwich	Snap-in	2.5	2-pole	●	straight	-	GSF1.2201.51
Sandwich	Snap-in	3	2-pole	●	straight	-	GSF1.2201.61
Rear Side	Screw	6	-	●	angled to pin axis	-	GSF1.0002.01
Rear Side	Screw	6	-	●	straight	-	GSF1.0001.01
Rear Side	Screw	6	1-pole	●	angled to pin axis	-	GSF1.1002.01
Rear Side	Screw	6	1-pole	●	straight	-	GSF1.1001.01
Rear Side	Screw	6	2-pole	●	angled to pin axis	-	GSF1.2002.01
Rear Side	Screw	6	2-pole	●	straight	-	GSF1.2001.01
Rear Side	Snap-in	6	-	●	angled to pin axis	-	GSF1.0202.01
Rear Side	Snap-in	6	-	●	straight	-	GSF1.0201.01

Mounting side	Panel mounting	Panel Thickness s [mm]	Fuseholder	Ground terminal 4.8 x 0.8 mm	Ground terminal direction	Packaging	Order Number
Rear Side	Snap-in	6	1-pole	●	angled to pin axis	-	GSF1.1202.01
Rear Side	Snap-in	6	1-pole	●	straight	-	GSF1.1201.01
Rear Side	Snap-in	6	2-pole	●	angled to pin axis	-	GSF1.2202.01
Rear Side	Snap-in	6	2-pole	●	straight	-	GSF1.2201.01
Rear Side	Metal snaps	6	-	●	angled to pin axis	Blister tray	GSF1.3402.01
Rear Side	Metal snaps	6	1-pole	●	angled to pin axis	Blister tray	GSF1.4402.01
Rear Side	Metal snaps	6	2-pole	●	angled to pin axis	Blister tray	GSF1.5402.01

Insulation cover must be ordered separately. Order No. 0098.0078

Optional blister tray packaging 250 Pcs

Packaging unit 50 Pcs

Accessories

Description

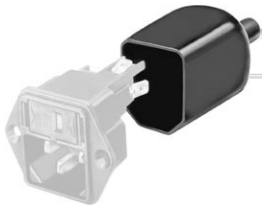

Assorted Covers
Rear Cover

Mating Outlets/Connectors

Category / Description

Appliance Outlet Overview complete



IEC Appliance Outlet F, Screw-on Mounting, Front Side, Solder Terminal	4787
IEC Appliance Outlet F, Snap-in Mounting, Front Side, Solder or Quick-connect Terminal	4788
IEC Appliance Outlet F or H, Screw-on Mounting, Front Side, Solder, PCB or Quick-connect Terminal	5091

[Appliance Outlet further types to GSF1](#)

Connector Overview complete



IEC Connector C15A, Rewireable, Straight	0102
IEC Connector C15A, Rewireable, Straight	0102-G
IEC Connector C15A, Rewireable, Angled	0112
IEC Connector C13, Rewireable, Angled	4012
IEC Connector C13, Rewireable, Straight	4022

[Connector further types to GSF1](#)

...