

NTL Series

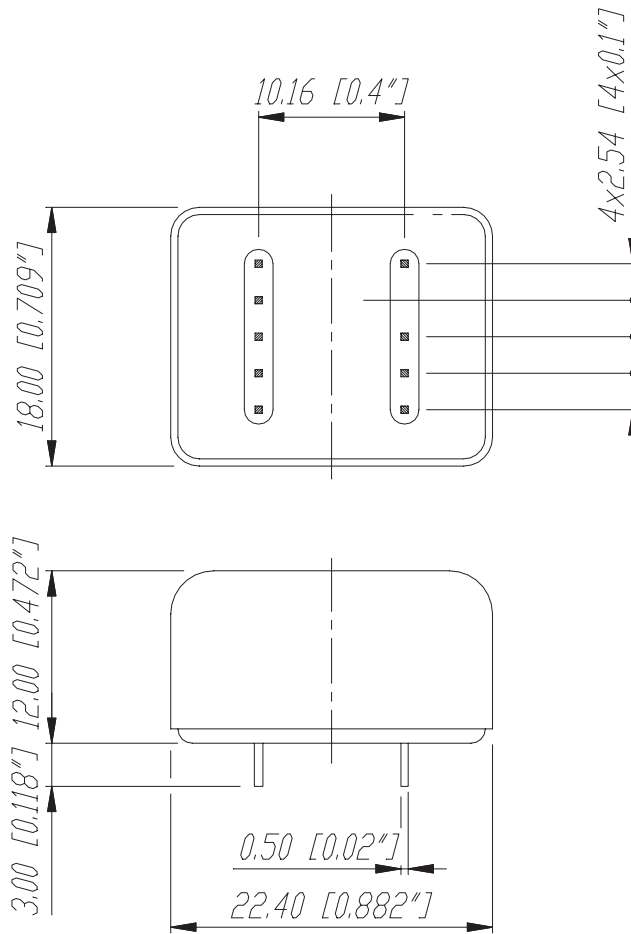

Print Layout:

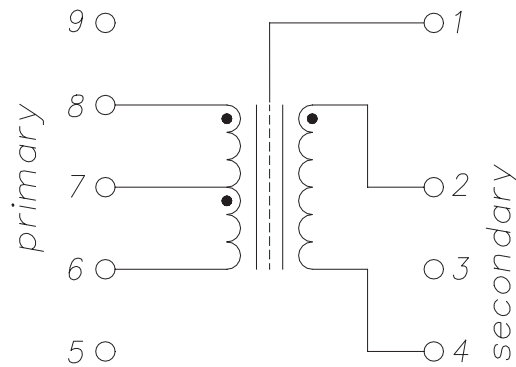

					Werkstoff:	Massstab:	Datum	Name
				*Lieferant darf ohne Ruecksprache nicht geaendert werden		2:1	Gezeichnet 25,05,98	Alinjak
				Zeichnung urheberrechtlich geschuetzt (DIN 34) (C)			Geprueft	
				Benennung:			Gesehen	
							Ersetzt durch:	Blatt
							Ersatz fuer:	von Blatt
A	Layout	23.04.02	Batlg				Zeichn. Nr.	3102 St 03 47
Ind.	Aenderung	Datum	Name	NTM 4				
				NEUTRIK AG FL-9494 SCHAAN				

Transformers

	Ripple 20Hz-20kHz	Max. input voltage (@60Hz) THD \leq 1%		THD \leq 3%	Min. load impedance
NTE1	max. -1dB	1,2 V	1,4 V		200 Ω
NTE4	max. -1dB	1,6 V	2,2 V		1 k Ω
NTE10/3	max. -2dB	1,2 V	1,6 V		10 k Ω
	Turns ratio	Winding resistance (DC)			Primary inductance at 30Hz
		primary	secondary		
NTL1	1 : 1 \pm 5%	1.1 k Ω \pm 5%	1.35 k Ω \pm 5%		\geq 150 H
NTM1	1 : 1 \pm 10%	85 Ω \pm 3%	105 Ω \pm 5%		\geq 8 H
NTM4	1 : 4 \pm 10%	105 Ω \pm 3%	1.25 k Ω \pm 5%		\geq 8 H

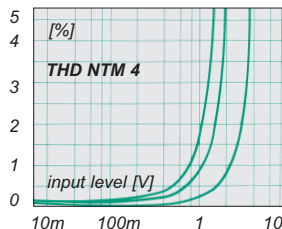
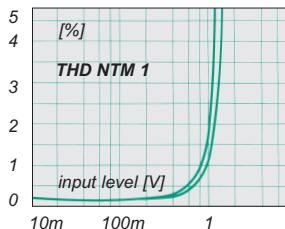
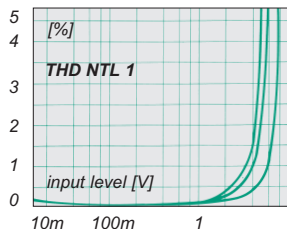
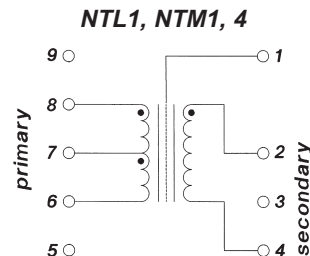
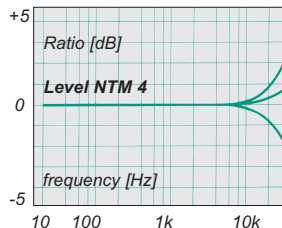
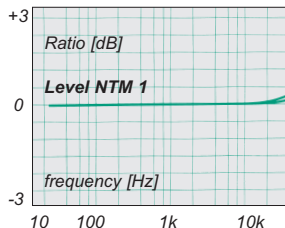
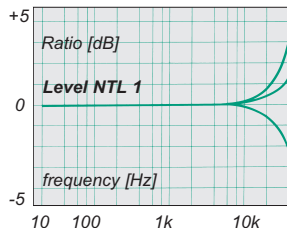
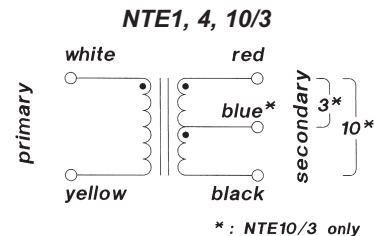

NTL1: typical application

