

TRIH

MAIN FEATURES

- Miniature heavy-duty relays
- Single-Pole, 10 Amp PC Board
- SPST and SPDT configurations
- 5KV dielectric coil to contacts
- Sealed & Unsealed types available

APPLICATIONS

- Microwave Oven, Facsimile, Refrigerator
- Air Conditioner, Stereo Equipment,
- Copier, TV Set, Vending Machine,
- Temperature Controllers, etc.

ORDERING INFORMATION

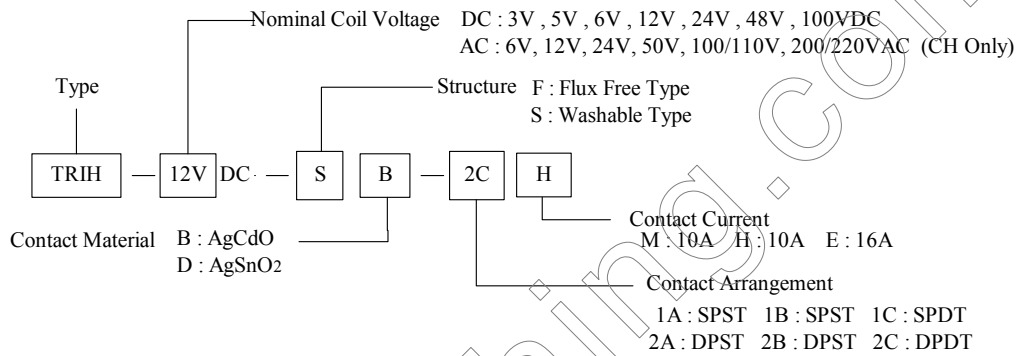

DIMENSION (unit:mm)

DRILLING (unit:mm)

WIRING DIAGRAM

16A

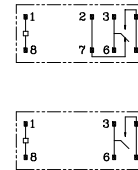
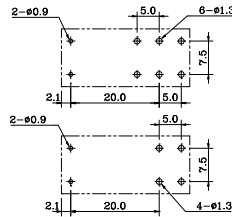
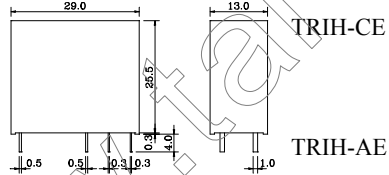

10A

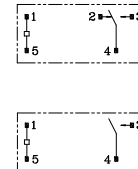
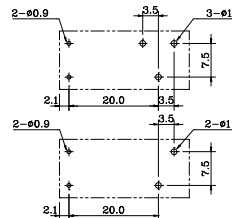
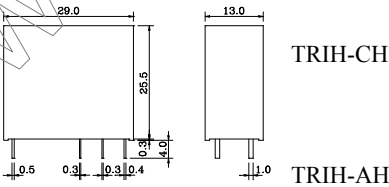

10A

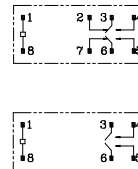
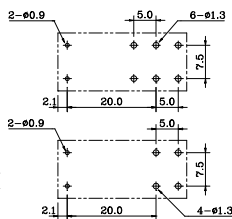
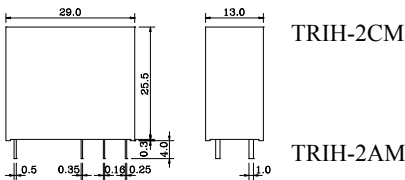

COIL DATA CHART (AT20°C)

Nominal voltage	Pick-Up voltage	Drop-out voltage	Nominal current	Coil resistance	Power consumption	Max. allowable voltage
DC Type (CH, TRIH)						
VDC	VDC(Max.)	VDC(Min.)	mA(±10%)	Ω (±10%)	(mW)	(VDC)
3	2.4	0.3	176	17	Approx. 530	110% of nominal voltage
5	3.75	0.5	106	47		
6	4.5	0.6	88.2	68		
9	6.75	0.9	56.2	160		
12	9.0	1.2	43.6	275		
24	18	2.4	21.8	1100±15%		
48	36	4.8	11.5	4170±15%		
60	45	6.0	5.3	7000±15%		
AC Type (CH ONLY) at 60 Hz						
VAC	VAC(Max.)	VAC(Min.)	mA(+10%,-15%)	Ω (±10%)	(VA)	(VAC)
6	4.8	1.8	150	16	Approx. 0.9 At 60 Hz	110% of nominal voltage
12	9.6	3.6	75	65		
24	19.2	7.2	37.5	260		
50	40	15	18	1130		
100/110	80/88	30/33	9/10.6	4600		
200/220	160/176	60/66	4.5/5.3	22000		

REFERENCE DATA

Maximum Switched Power

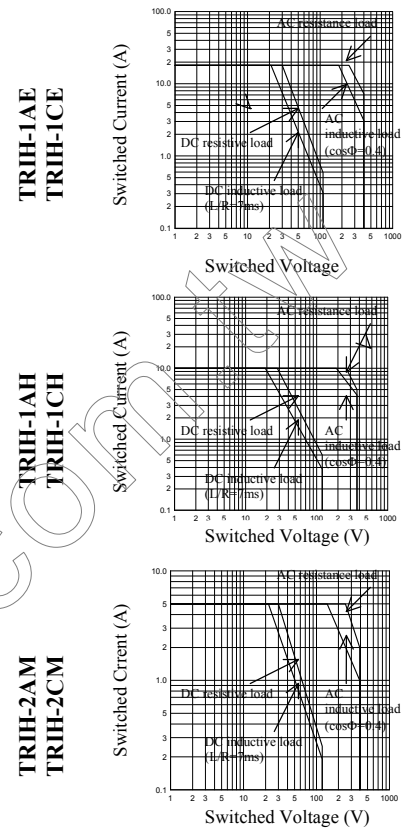

Electrical Life Expectancy

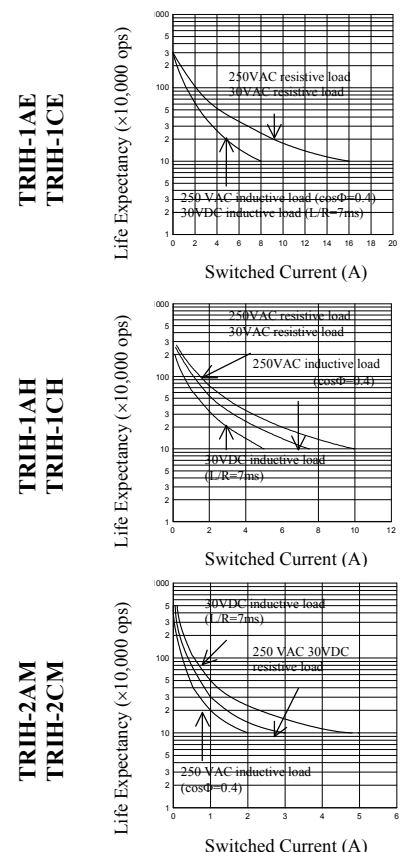

CONTACT RATING

Arrangement		SPST-NO(1a), SPDT(1c)	SPST-NO(1a), SPDT(1c)	DPST-NO(2a), DPDT(2c)
Item	Rated load	E-Type		
		H-Type	M-Type	
UL	Resistive load (cosφ=1)	16A 250VAC 16A 30VDC	10A 250VAC 10A 30VDC	10A 250VAC 10A 30VDC
	Inductive load (cosφ=0.4) TV Rating	8A 250VAC, 8A 30VDC TV-8 / 125VAC 1/2HP 125VAC, 1HP 250VAC	7.5A 250VAC, 5A 30VDC TV-5 / 125VAC 1/3HP 250VAC, 1/4HP 125VAC	2A 250VAC, 3A 30VDC TV-3 / 125VAC 1/4HP 277/125VAC
	TUV	16A 250VAC / 16A 30VDC	10A 250VAC / 10A 30VDC	5A 250VAC / 5A 30VDC
Carrying current		16A	12A	10A
Max. switching voltage		380VAC, 125VDC	380VAC, 125VDC	380VAC, 125VDC
Max. switching current		16A	12A	10A
Max. switching power		4432VA, 480W	2000VA, 240W	3324VA, 360W
Min. permissible load		5VDC 100mA		5VDC 10mA
Contact material		Ag Alloy		

PERFORMANCE (at initial value)

Contact Resistance	Max. 50mΩ
Operation time (at nominal voltage)	Max. 15msec
Release time (at nominal voltage)	Max. 10msec
Operating frequency	20ops/minute
Insulation resistance	Min. 100MΩ (at 500VDC)
Vibration resistance	Functional : 10 to 55 Hz, 1.5mm double amplitude Destructive : 10 to 55 Hz, 1.5mm double amplitude
Shock resistance	Functional : Min, 10 G Destructive : Min, 100G
Dielectric strength	5000VAC. for 1 minute between coil and contact. 3000VAC. for 1 minute between contact sets. 1000VAC. for 1 minute between open contacts.
Ambient temperature	Storage : -40 to +70°C Operating : -40 to +70°C
Humidity	35 to 85% RH
Life expectancy	Mechanical : DC 2×10 ⁷ operations AC 1×10 ⁷ operations Electrical : 1×10 ⁵ operations (at rated load)
Weight	Approx. 17grs.
U/L File NO	E156521
TUV	R9659294/-96/-98