



TRB

TRBS Coil Terminal
Arranged on One Side

MAIN FEATURES

- Subminiature Type.
- Silver or Silver Alloy Contacts with Gold Plated.
- Low Dissipation.
- Sealed Type Available.
- Design conforms to foreign safety standard UL.

APPLICATIONS

- Microprocessor Control, Store Program Exchanger and Household Appliance.

ORDERING INFORMATION

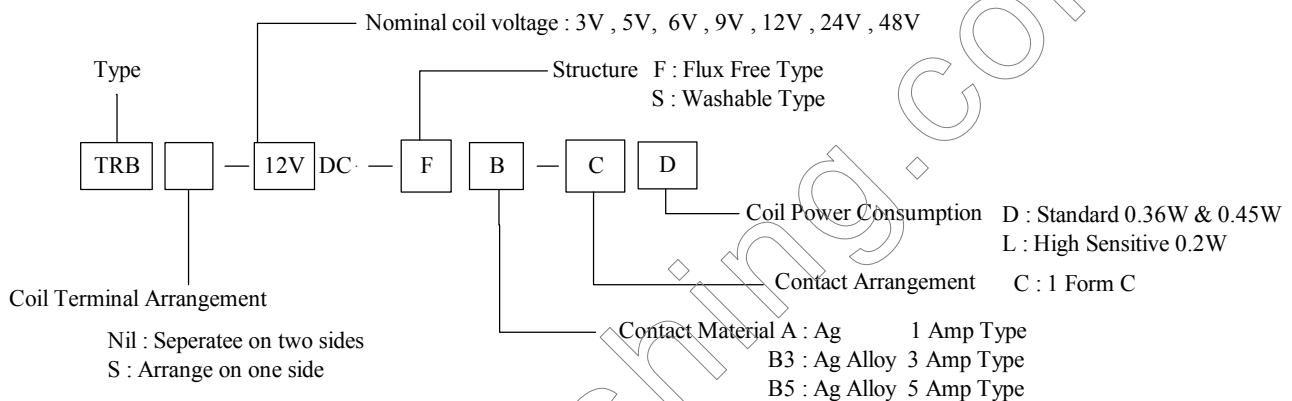

DIMENSION (unit:mm)

DRILLING (unit:mm)

WIRING DIAGRAM

TRB

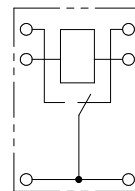
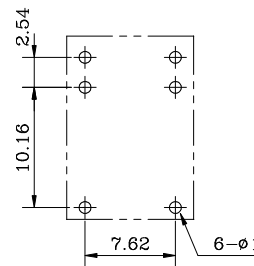
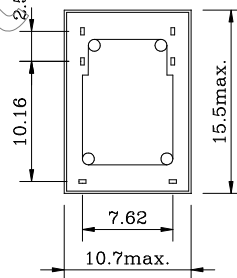
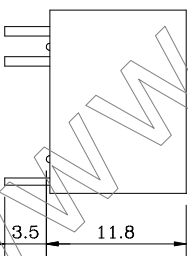

TRBS

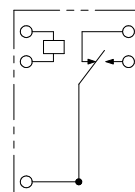
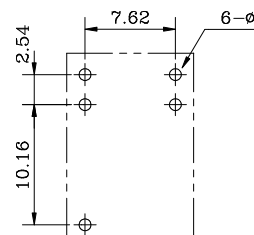
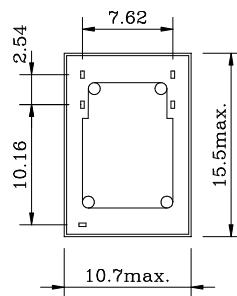
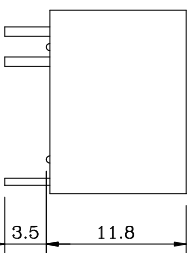

COIL DATA CHART (AT20°C)

Coil Sensitivity	Coil Voltage Code	Nominal Voltage (VDC)	Nominal Current (mA)	Coil Resistance (Ω) $\pm 10\%$	Power Consumption (W)	Pull-In Voltage (VDC)	Drop-Out Voltage (VDC)	Max-Allowable Voltage (VDC)
TRB□-B (High Sensitivity) 1 Amp type	03	03	66.7	45	abt. 0.2 W	75% Max.	10% Min.	110%
	05	05	40	125				
	06	06	33.3	180				
	09	09	22.2	405				
	12	12	16.7	720				
	24	24	8.3	2880				
TRB□-B3 (Standard) 3 Amp type	03	03	120	25	abt. 0.36W	75% Max.	10% Min.	110%
	05	05	66.7	75				
	06	06	60	100				
	09	09	40.9	220				
	12	12	30	400				
	24	24	15	1600				
TRB□-B5 (High Capacity) 5 Amp type	03	03	150	20	abt. 0.45W	75% Max.	10% Min.	110%
	05	05	89.3	56				
	06	06	75	80				
	09	09	50	180				
	12	12	37.5	320				
	24	24	18.75	1280				

CONTACT RATING

Item	Type	TRB-B/TRBS	TRB-B3	TRB-B5
		1 Amp type	3 Amp type	5 Amp type
Contact Capacity		Coil=0.2W	Coil=0.36W	Coil=0.45W
Resistive Load ($\cos\Phi=1$)		1A 125VAC 1A 30VDC	3A 125VAC 3A 30VDC	5A 125VAC 5A 14VDC
Inductive Load ($\cos\Phi=0.4$ L/R=7msec)			0.3A 125VAC 0.3A 30VDC	
Rated Carrying Current		1 A	3 A	5 A
Max. Allowable Voltage		125VAC, 30VDC		
Max. Allowable Current		1 A	3 A	5 A
Max. Allowable Power Force		125VA, 30W	375VA, 72W	625VA, 70W
Contact Material		Ag Alloy		

Coil Temperature Rise

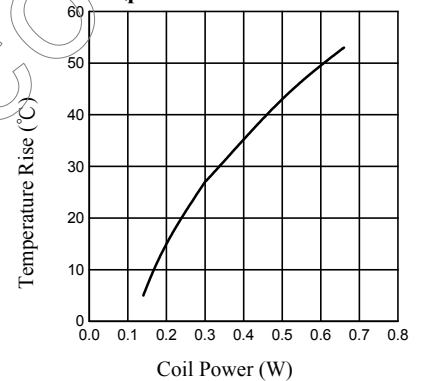

PERFORMANCE (at initial value)

Item	Type	TRB/TRBS
Contact Resistance		100m Ω Max.
Operation Time		5msec Max.
Release Time		5msec Max.
Dielectric Strength		
Between coil & contact		500VAC 50/60HZ (1 minute)
Between contacts		500VAC 50/60HZ (1 minute)
Surge Resistiveness		1000V (between coil & contact 1 \times 40 usec)
Insulation Resistance		100 M Ω Min. (500VDC)
Max. ON/OFF Switching		
Mechanically		300 operation/min
Electrically		30 operation/min
Operating Ambient Temperature		-25°C to +55°C (No water condensation and no water drop)
Operating Humidity		45 to 85% RH
Coil Temperature Rise		40 deg. Max. (at rated coil voltage)
Vibration		
Endurance		10 to 55HZ Single Amplitude 0.35mm
Error Operation		10 to 55HZ Single Amplitude 0.35mm
Shock		
Endurance		50G Min.
Error Operation		10G Min.
Life Expectancy		
Mechanically		10 \times 10 ⁶ operations. Min. (no load)
Electrically		10 \times 10 ⁴ operations. Min. (at rated coil voltage)
Weight		abt. 3.5grs.
UL File No.		E156521

Operation time

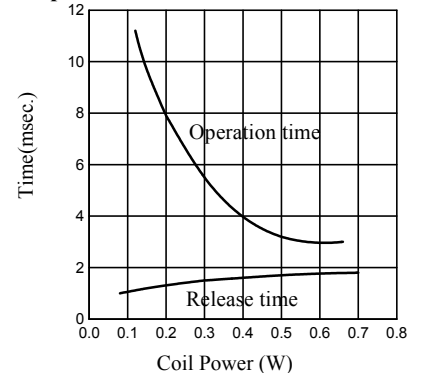

Life Expectancy

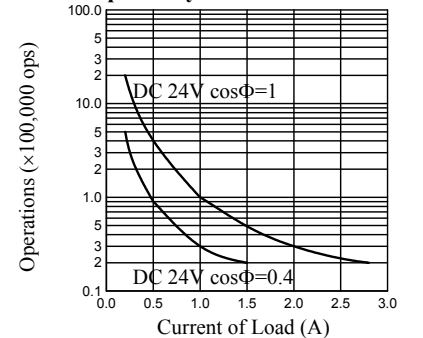

REFERENCE DATA