

150mA, Low-Dropout Regulator, Ultralow-Power, I_Q 500nA with Pin-Selectable, Dual-Level Output Voltage

FEATURES

- Low I_Q : 500nA
- 150mA, Low-Dropout Regulator with Pin-Selectable Dual Voltage Level Output
- Low Dropout: 200mV at 150mA
- 3% Accuracy Over Load/Line/Temperature
- Available in Dual-Level, Fixed Output Voltages from 1.5V to 4.2V Using Innovative Factory EPROM Programming
- Available in an Adjustable Version from 1.22V to 5.25V or a Dual-Level Output Version
- V_{SET} Pin Toggles Output Voltage Between Two Factory-Programmed Voltage Levels
- Stable with a 1.0 μ F Ceramic Capacitor
- Thermal Shutdown and Overcurrent Protection
- CMOS Logic Level-Compatible Enable Pin
- Available in DDC (TSOT23-5) or DRV (2mm \times 2mm SON-6) Package Options

APPLICATIONS

- TI **MSP430** Attach Applications
- Power Rails with Programming Mode
- Dual Voltage Levels for Power-Saving Mode
- Wireless Handsets, Smartphones, PDAs, MP3 Players, and Other Battery-Operated Handheld Products

DESCRIPTION

The TPS780 family of low-dropout (LDO) regulators offer the benefits of ultralow power ($I_Q = 500$ nA), miniaturized packaging (2 \times 2 SON-6), and selectable dual-level output voltage levels. An adjustable version is also available, but does not have the capability to shift voltage levels.

The V_{SET} pin allows the end user to switch between two voltage levels *on-the-fly* through a microprocessor-compatible input. This LDO is designed specifically for battery-powered applications where dual-level voltages are needed. With ultralow I_Q (500nA), microprocessors, memory cards, and smoke detectors are ideal applications for this device.

The ultralow-power and selectable dual-level output voltages allow designers to customize power consumption for specific applications. Designers can now shift to a lower voltage level in a battery-powered design when the microprocessor is in sleep mode, further reducing overall system power consumption. The two voltage levels are preset at the factory through a unique architecture using an EPROM. The EPROM technique allows for numerous output voltage options between V_{SET} low (1.5V to 4.2V) and V_{SET} high (2.0V to 3.0V) in the fixed output version only. Consult with your local factory representative for exact voltage options and ordering information; minimum order quantities may apply.

The TPS780 series are designed to be compatible with the TI MSP430 and other similar products. The enable pin is compatible with standard CMOS logic. This LDO is stable with any output capacitor greater than 1.0 μ F. Therefore, implementations of this device require minimal board space because of miniaturized packaging and a potentially small output capacitor. The TPS780 series I_Q (500nA) also come with thermal shutdown and current limit to protect the device during fault conditions. All packages have an operating temperature range of $T_J = -40^\circ\text{C}$ to $+125^\circ\text{C}$. For more cost-sensitive applications requiring a dual-level voltage option and only *on par* I_Q , consider the [TPS781 series](#), with an I_Q of 1.0 μ A and dynamic voltage scaling.

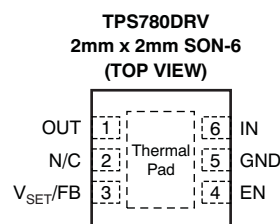
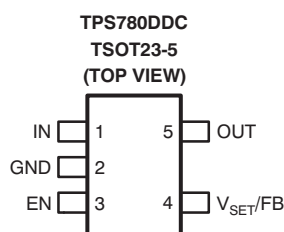

Please be aware that an important notice concerning availability, standard warranty, and use in critical applications of Texas Instruments semiconductor products and disclaimers thereto appears at the end of this data sheet.

All trademarks are the property of their respective owners.



This integrated circuit can be damaged by ESD. Texas Instruments recommends that all integrated circuits be handled with appropriate precautions. Failure to observe proper handling and installation procedures can cause damage.

ESD damage can range from subtle performance degradation to complete device failure. Precision integrated circuits may be more susceptible to damage because very small parametric changes could cause the device not to meet its published specifications.

ORDERING INFORMATION⁽¹⁾⁽²⁾

| PRODUCT | V _{OUT} |
|------------------|--|
| TPS780vvvxxxyyyz | VVV is the nominal output voltage for V _{OUT(HIGH)} and corresponds to V _{SET} pin low. XXX is the nominal output voltage for V _{OUT(LOW)} and corresponds to V _{SET} pin high. YYY is the package designator. Z is the tape and reel quantity (R = 3000, T = 250). Adjustable version ⁽³⁾⁽⁴⁾ |

- (1) For the most current package and ordering information see the Package Option Addendum at the end of this document, or see the TI web site at www.ti.com.
- (2) Additional output voltage combinations are available on a quick-turn basis using innovative, factory EPROM programming. Minimum-order quantities apply; contact your sales representative for details and availability.
- (3) To order the adjustable version, use TPS78001YYYZ.
- (4) The device is either fixed voltage, dual-level V_{OUT}, or adjustable voltage only. Device design does not permit a fixed and adjustable output simultaneously.

ABSOLUTE MAXIMUM RATINGS⁽¹⁾

At T_J = –40°C to +125°C, unless otherwise noted. All voltages are with respect to GND.

| PARAMETER | TPS780 Series | UNIT |
|--|---|-------|
| Input voltage range, V _{IN} | –0.3 to +6.0 | V |
| Enable and V _{SET} voltage range, V _{EN} and V _{VSET} | –0.3 to V _{IN} + 0.3 ⁽²⁾ | V |
| Output voltage range, V _{OUT} | –0.3 to V _{IN} + 0.3V | V |
| Maximum output current, I _{OUT} | Internally limited | |
| Output short-circuit duration | Indefinite | |
| Total continuous power dissipation, P _{DISS} | See the Dissipation Ratings table | |
| ESD rating | Human body model (HBM) | 2 kV |
| | Charged device model (CDM) | 500 V |
| Operating junction temperature range, T _J | –40 to +125 | °C |
| Storage temperature range, T _{STG} | –55 to +150 | °C |

- (1) Stresses above these ratings may cause permanent damage. Exposure to absolute maximum conditions for extended periods may degrade device reliability. These are stress ratings only, and functional operation of the device at these or any other conditions beyond those specified is not implied.
- (2) V_{EN} and V_{VSET} absolute maximum rating are V_{IN} + 0.3V or +6.0V, whichever is less.

DISSIPATION RATINGS

| BOARD | PACKAGE | R _{θJC} | R _{θJA} | DERATING FACTOR ABOVE T _A = +25°C | T _A < +25°C | T _A = +70°C | T _A = +85°C |
|-----------------------|---------|------------------|------------------|--|------------------------|------------------------|------------------------|
| High-K ⁽¹⁾ | DRV | 20°C/W | 65°C/W | 15.4mW/°C | 1540mW | 845mW | 615mW |
| High-K ⁽¹⁾ | DDC | 90°C/W | 200°C/W | 5.0mW/°C | 500mW | 275mW | 200mW |

- (1) The JEDEC high-K (2s2p) board used to derive this data was a 3-inch × 3-inch, multilayer board with 1-ounce internal power and ground planes and 2-ounce copper traces on top and bottom of the board.

ELECTRICAL CHARACTERISTICS

Over operating temperature range ($T_J = -40^{\circ}\text{C}$ to $+125^{\circ}\text{C}$), $V_{IN} = V_{OUT(NOM)} + 0.5\text{V}$ or 2.2V , whichever is greater; $I_{OUT} = 100\mu\text{A}$, $V_{VSET} = V_{EN} = V_{IN}$, $C_{OUT} = 1.0\mu\text{F}$, fixed or adjustable, unless otherwise noted. Typical values at $T_J = +25^{\circ}\text{C}$.

| PARAMETER | | TEST CONDITIONS | TPS780 Series | | | UNIT |
|---------------------------------|--|---|--|----------|-----|---------------------|
| | | | MIN | TYP | MAX | |
| V_{IN} | Input voltage range | | 2.2 | | 5.5 | V |
| $V_{OUT}^{(1)}$ | DC output accuracy | Nominal | $T_J = +25^{\circ}\text{C}$, $V_{SET} = \text{high/low}$ | | | % |
| | | Over V_{IN} , I_{OUT} , temperature | $V_{OUT} + 0.5\text{V} \leq V_{IN} \leq 5.5\text{V}$, $0\text{mA} \leq I_{OUT} \leq 150\text{mA}$, $V_{SET} = \text{high/low}$ | | | % |
| V_{FB} | Internal reference ⁽²⁾ (adjustable version only) | $T_J = +25^{\circ}\text{C}$, $V_{IN} = 4.0\text{V}$, $I_{OUT} = 75\text{mA}$ | 1.216 | | | V |
| V_{OUT_RANGE} | Output voltage range ⁽³⁾⁽⁴⁾ (adjustable version only) | $V_{IN} = 5.5\text{V}$, $I_{OUT} = 100\mu\text{A}^{(2)}$ | V_{FB} | 5.25 | | V |
| $\Delta V_{OUT}/\Delta V_{IN}$ | Line regulation | $V_{OUT(NOM)} + 0.5\text{V} \leq V_{IN} \leq 5.5\text{V}$, $I_{OUT} = 5\text{mA}$ | -1 | +1 | | % |
| $\Delta V_{OUT}/\Delta I_{OUT}$ | Load regulation | $0\text{mA} \leq I_{OUT} \leq 150\text{mA}$ | -2 | +2 | | % |
| V_{DO} | Dropout voltage ⁽⁵⁾ | $V_{IN} = 95\% V_{OUT(NOM)}$, $I_{OUT} = 150\text{mA}$ | 250 | | | mV |
| V_N | Output noise voltage | $BW = 100\text{Hz}$ to 100kHz , $V_{IN} = 2.2\text{V}$, $V_{OUT} = 1.2\text{V}$, $I_{OUT} = 1\text{mA}$ | 86 | | | μV_{RMS} |
| V_{HI} | V_{SET} high (output $V_{OUT(LOW)}$ selected), or EN high (enabled) | | 1.2 | V_{IN} | | V |
| V_{LO} | V_{SET} low (output $V_{OUT(HIGH)}$ selected), or EN low (disabled) | | 0 | 0.4 | | V |
| I_{CL} | Output current limit | $V_{OUT} = 0.90 \times V_{OUT(NOM)}$ | 150 | 230 | 400 | mA |
| I_{GND} | Ground pin current | $I_{OUT} = 0\text{mA}^{(6)}$ | 420 | | | nA |
| | | $I_{OUT} = 150\text{mA}$ | 5 | | | μA |
| I_{SHDN} | Shutdown current (I_{GND}) | $V_{EN} \leq 0.4\text{V}$, $2.2\text{V} \leq V_{IN} < 5.5\text{V}$, $T_J = -40^{\circ}\text{C}$ to $+100^{\circ}\text{C}$ | 18 | 130 | | nA |
| I_{VSET} | V_{SET} pin current | $V_{EN} = V_{VSET} = 5.5\text{V}$ | 70 | | | nA |
| I_{EN} | EN pin current | $V_{EN} = V_{VSET} = 5.5\text{V}$ | 40 | | | nA |
| I_{FB} | FB pin current ⁽⁷⁾ (adjustable version only) | $V_{IN} = 5.5\text{V}$, $V_{OUT} = 1.2\text{V}$, $I_{OUT} = 100\mu\text{A}$ | 10 | | | nA |
| PSRR | Power-supply rejection ratio | $V_{IN} = 4.3\text{V}$, $V_{OUT} = 3.3\text{V}$, $I_{OUT} = 150\text{mA}$ | $f = 10\text{Hz}$ | 40 | | dB |
| | | | $f = 100\text{Hz}$ | 20 | | dB |
| | | | $f = 1\text{kHz}$ | 15 | | dB |
| $t_{TR(H \rightarrow L)}$ | V_{OUT} transition time (high-to-low) $V_{OUT} = 97\% \times V_{OUT(HIGH)}$ | $V_{OUT_LOW} = 2.2\text{V}$, $V_{OUT(HIGH)} = 3.3\text{V}$, $I_{OUT} = 10\text{mA}$ | 800 | | | μs |
| $t_{TR(L \rightarrow H)}$ | V_{OUT} transition time (low-to-high) $V_{OUT} = 97\% \times V_{OUT(LOW)}$ | $V_{OUT_HIGH} = 3.3\text{V}$, $V_{OUT(LOW)} = 2.2\text{V}$, $I_{OUT} = 10\text{mA}$ | 800 | | | μs |
| t_{STR} | Startup time ⁽⁸⁾ | $C_{OUT} = 1.0\mu\text{F}$, $V_{OUT} = 10\% V_{OUT(NOM)}$ to $V_{OUT} = 90\% V_{OUT(NOM)}$ | 500 | | | μs |
| t_{SHDN} | Shutdown time ⁽⁹⁾ | $I_{OUT} = 150\text{mA}$, $C_{OUT} = 1.0\mu\text{F}$, $V_{OUT} = 2.8\text{V}$, $V_{OUT} = 90\% V_{OUT(NOM)}$ to $V_{OUT} = 10\% V_{OUT(NOM)}$ | 500 ⁽¹⁰⁾ | | | μs |
| T_{SD} | Thermal shutdown temperature | Shutdown, temperature increasing | +160 | | | $^{\circ}\text{C}$ |
| | | Reset, temperature decreasing | +140 | | | $^{\circ}\text{C}$ |
| T_J | Operating junction temperature | | -40 | +125 | | $^{\circ}\text{C}$ |

- (1) The output voltage for $V_{SET} = \text{low/high}$ is programmed at the factory.
- (2) Adjustable version only.
- (3) No V_{SET} pin on the adjustable version.
- (4) No dynamic voltage scaling on the adjustable version.
- (5) V_{DO} is not measured for devices with $V_{OUT(NOM)} < 2.3\text{V}$ because minimum $V_{IN} = 2.2\text{V}$.
- (6) $I_{GND} = 800\text{nA}$ (max) up to $+100^{\circ}\text{C}$.
- (7) The TPS78001 FB pin is tied to V_{OUT} . Adjustable version only.
- (8) Time from $V_{EN} = 1.2\text{V}$ to $V_{OUT} = 90\%$ ($V_{OUT(NOM)}$).
- (9) Time from $V_{EN} = 0.4\text{V}$ to $V_{OUT} = 10\%$ ($V_{OUT(NOM)}$).
- (10) See [Shutdown](#) in the [Application Information](#) section for more details.

FUNCTIONAL BLOCK DIAGRAM

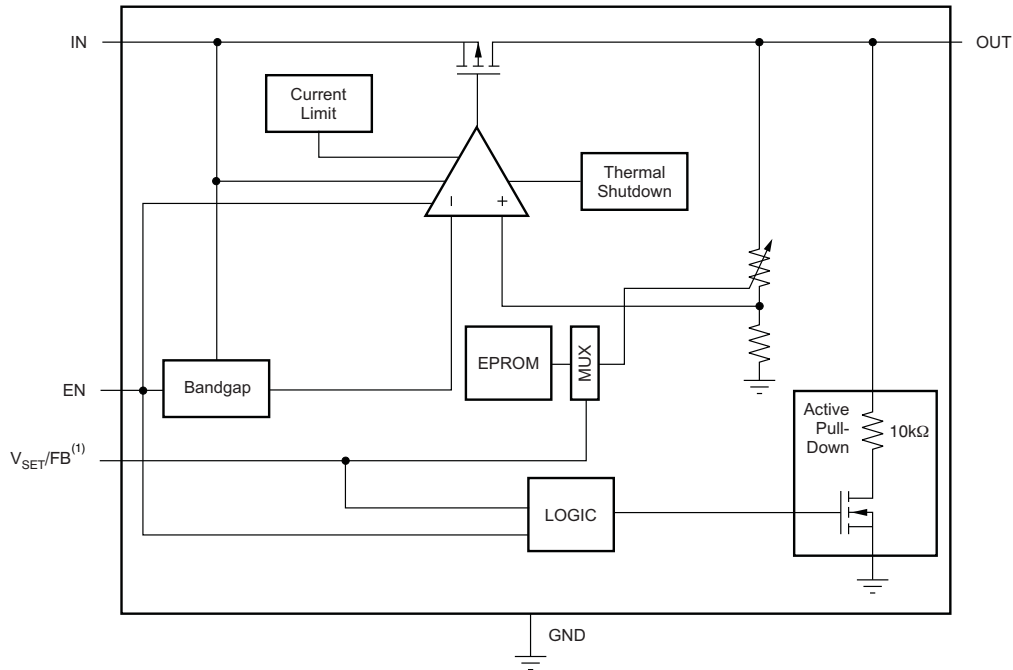

(1) Feedback pin (FB) for adjustable versions; V_{SET} for fixed voltage versions.

PIN CONFIGURATIONS

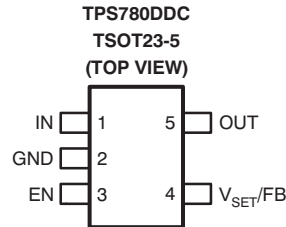
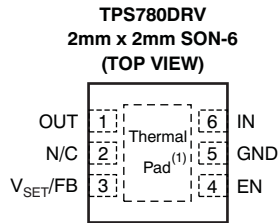

(1) It is recommended that the SON package thermal pad be connected to ground.

Table 1. TERMINAL FUNCTIONS

| TERMINAL | | | DESCRIPTION |
|--------------|-------------|-----|---|
| NAME | DRV | DDC | |
| OUT | 1 | 5 | Regulated output voltage pin. A small (1 μ F) ceramic capacitor is needed from this pin to ground to assure stability. See the <i>Input and Output Capacitor Requirements</i> in the Application Information section for more details. |
| N/C | 2 | — | Not connected. |
| V_{SET}/FB | 3 | 4 | Feedback pin (FB) for adjustable versions; V_{SET} for fixed voltage versions. Driving the select pin (V_{SET}) below 0.4V selects preset output voltage high. Driving the V_{SET} pin over 1.2V selects preset output voltage low. |
| EN | 4 | 3 | Driving the enable pin (EN) over 1.2V turns on the regulator. Driving this pin below 0.4V puts the regulator into shutdown mode, reducing operating current to 18nA typical. |
| GND | 5 | 2 | Ground pin. |
| IN | 6 | 1 | Input pin. A small capacitor is needed from this pin to ground to assure stability. Typical input capacitor = 1.0 μ F. Both input and output capacitor grounds should be tied back to the IC ground with no significant impedance between them. |
| Thermal pad | Thermal pad | — | It is recommended that the SON package thermal pad be connected to ground. |

TYPICAL CHARACTERISTICS

Over the operating temperature range of $T_J = -40^\circ\text{C}$ to $+125^\circ\text{C}$, $V_{IN} = V_{OUT(TYP)} + 0.5\text{V}$ or 2.2V , whichever is greater; $I_{OUT} = 100\mu\text{A}$, $V_{EN} = V_{VSET} = V_{IN}$, $C_{OUT} = 1\mu\text{F}$, and $C_{IN} = 1\mu\text{F}$, unless otherwise noted.

LINE REGULATION
 $I_{OUT} = 5\text{mA}$, $V_{OUT} = 1.22\text{V}$ (typ)
 TPS78001

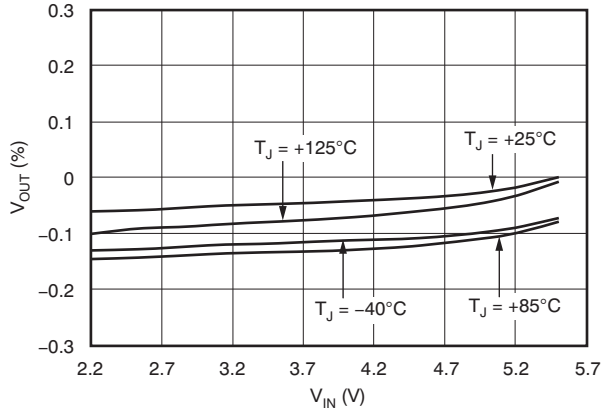

Figure 1.

LINE REGULATION
 $I_{OUT} = 5\text{mA}$, $V_{VSET} = 1.2\text{V}$, $V_{OUT} = 2.2\text{V}$ (typ)
 TPS780330220

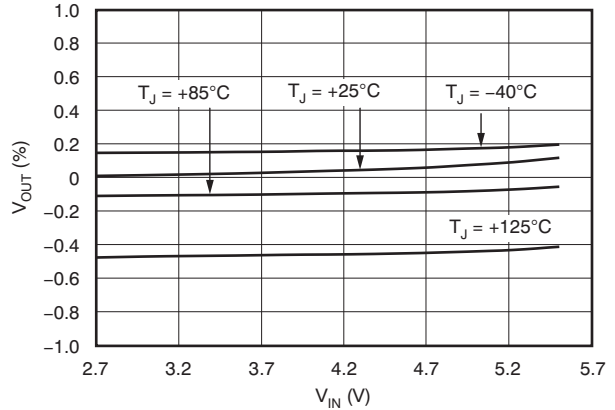

Figure 2.

LINE REGULATION
 $I_{OUT} = 150\text{mA}$, $V_{VSET} = 1.2\text{V}$, $V_{OUT} = 2.2\text{V}$ (typ)
 TPS780330220

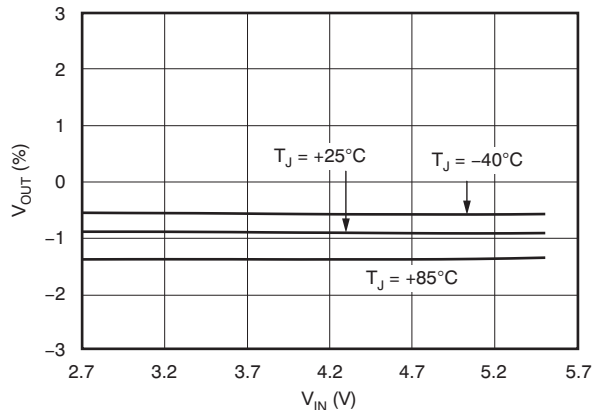

Figure 3.

LINE REGULATION
 $I_{OUT} = 5\text{mA}$, $V_{VSET} = 0.4\text{V}$, $V_{OUT} = 3.3\text{V}$ (typ)
 TPS780330220

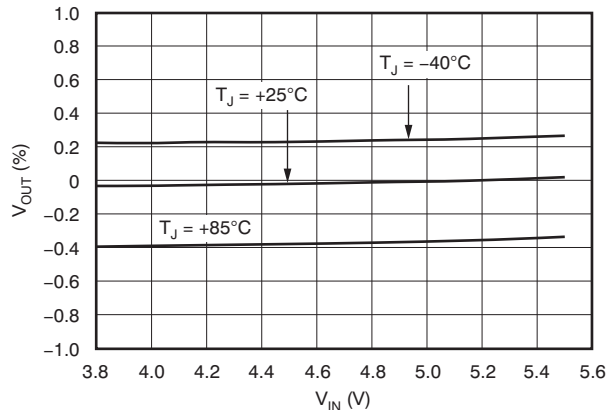

Figure 4.

LINE REGULATION
 $I_{OUT} = 150\text{mA}$, $V_{VSET} = 0.4\text{V}$, $V_{OUT} = 3.3\text{V}$ (typ)
 TPS780330220

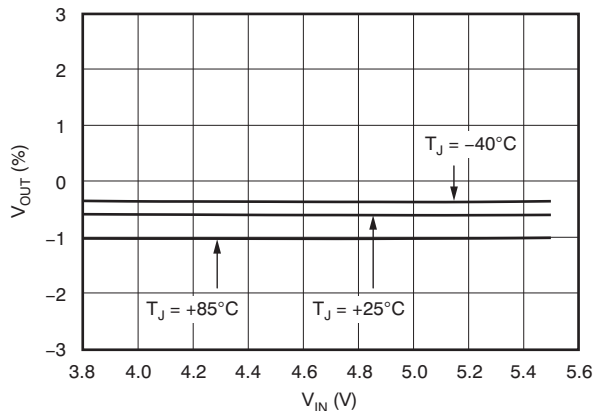

Figure 5.

LOAD REGULATION
 $V_{OUT} = 3.3\text{V}$
 TPS78001

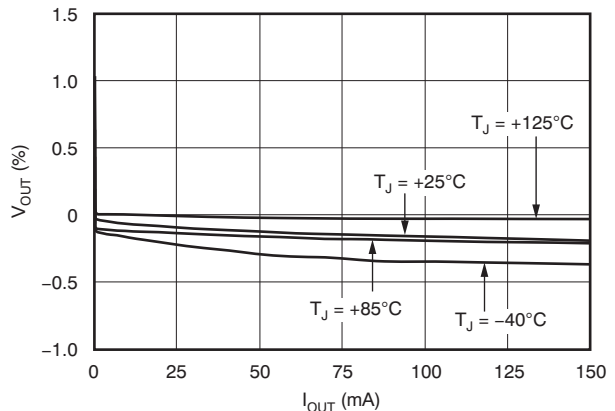

Figure 6.

TYPICAL CHARACTERISTICS (continued)

Over the operating temperature range of $T_J = -40^\circ\text{C}$ to $+125^\circ\text{C}$, $V_{IN} = V_{OUT(TYP)} + 0.5\text{V}$ or 2.2V , whichever is greater; $I_{OUT} = 100\mu\text{A}$, $V_{EN} = V_{VSET} = V_{IN}$, $C_{OUT} = 1\mu\text{F}$, and $C_{IN} = 1\mu\text{F}$, unless otherwise noted.

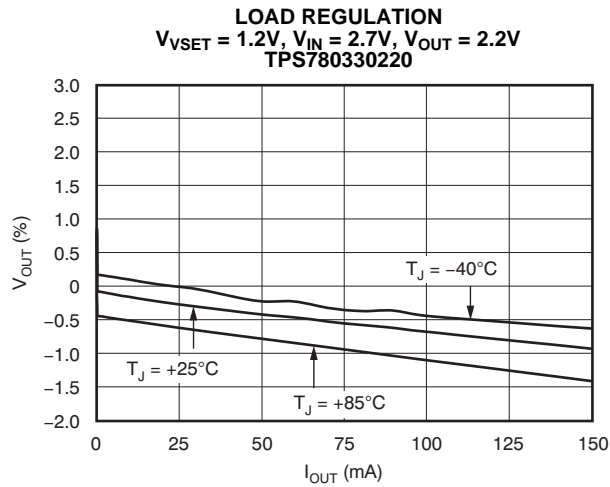

Figure 7.

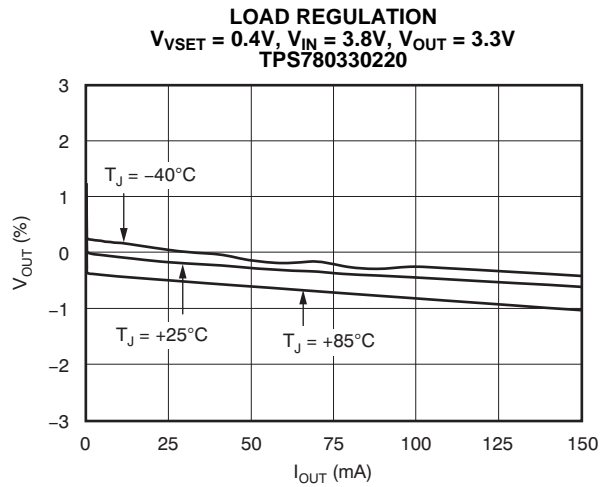

Figure 8.

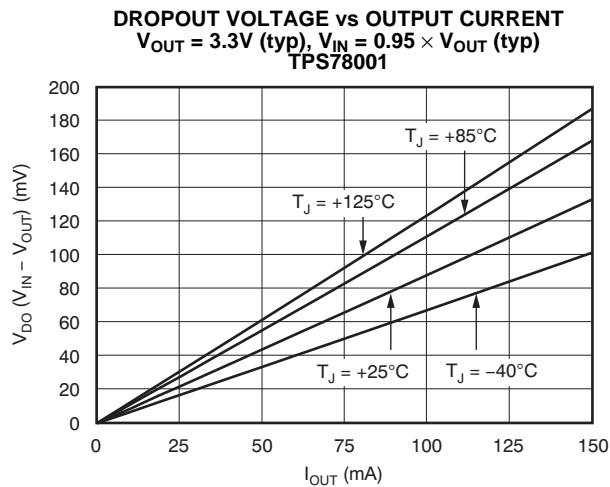

Figure 9.

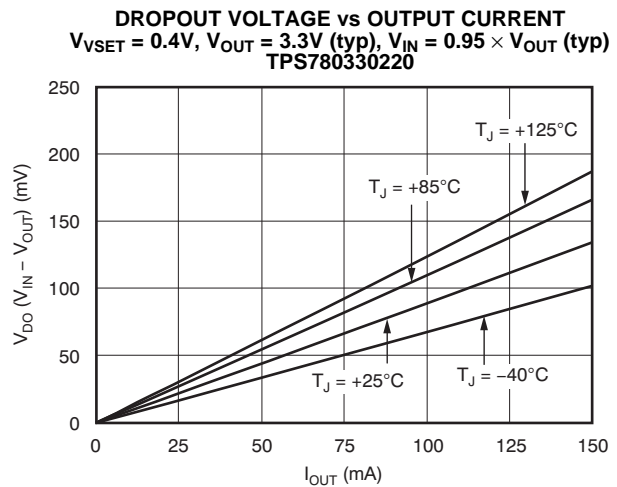

Figure 10.

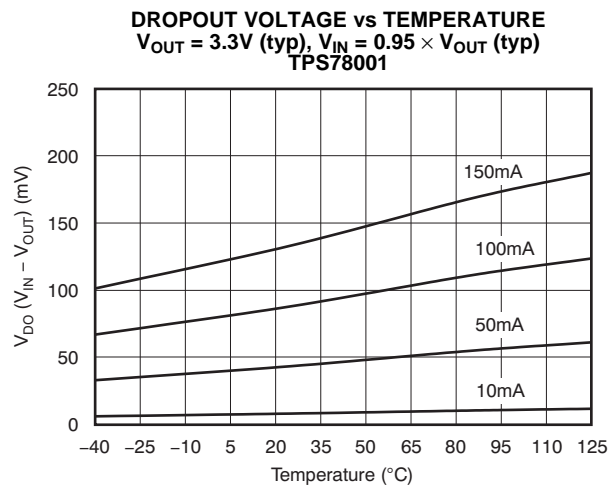

Figure 11.

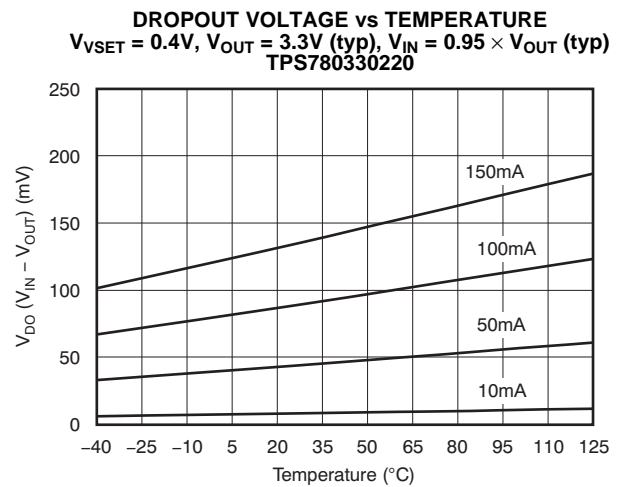

Figure 12.

TYPICAL CHARACTERISTICS (continued)

Over the operating temperature range of $T_J = -40^\circ\text{C}$ to $+125^\circ\text{C}$, $V_{IN} = V_{OUT(TYP)} + 0.5\text{V}$ or 2.2V , whichever is greater; $I_{OUT} = 100\mu\text{A}$, $V_{EN} = V_{VSET} = V_{IN}$, $C_{OUT} = 1\mu\text{F}$, and $C_{IN} = 1\mu\text{F}$, unless otherwise noted.

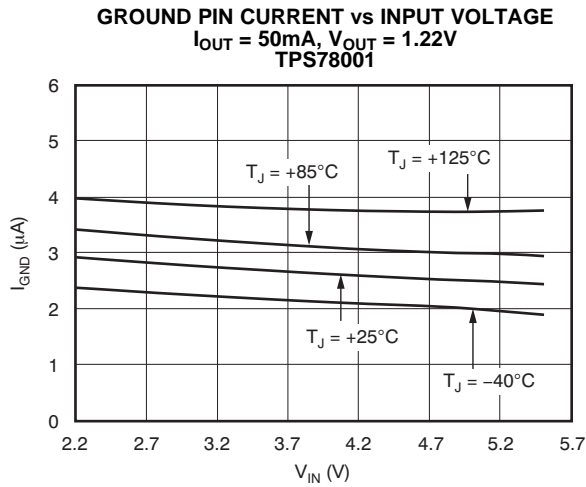

Figure 13.

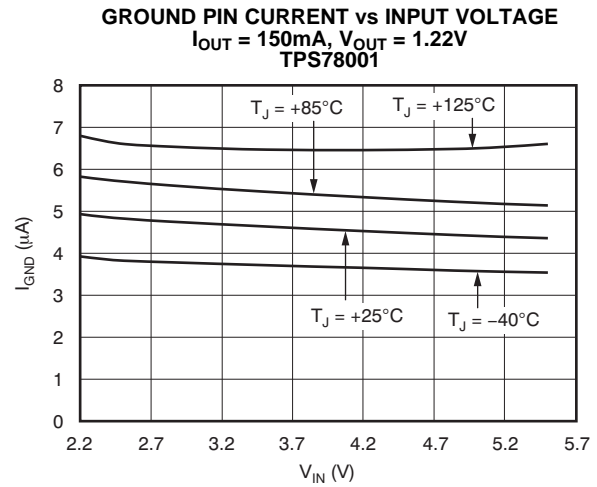

Figure 14.

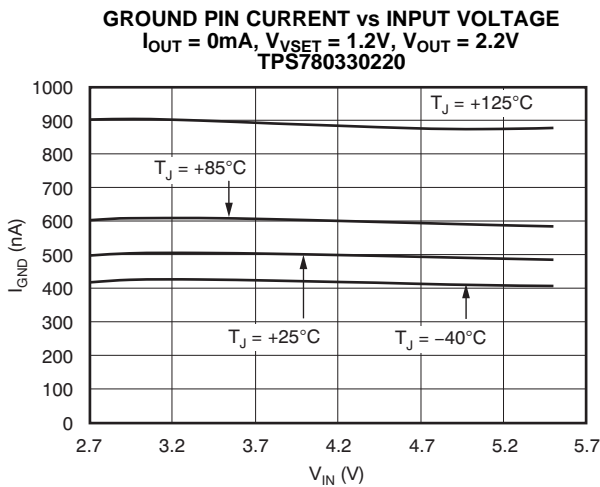

Figure 15.

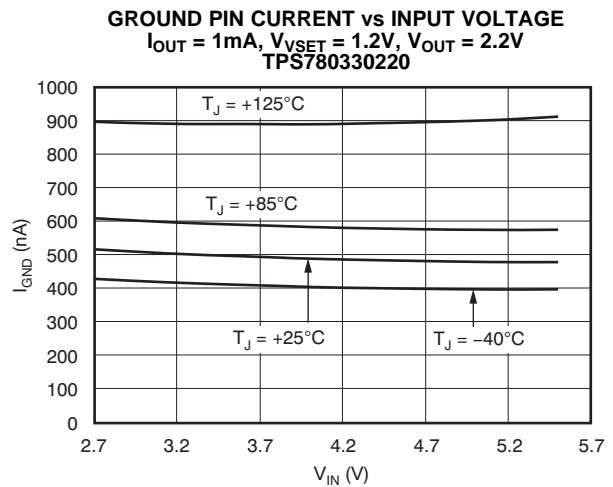

Figure 16.

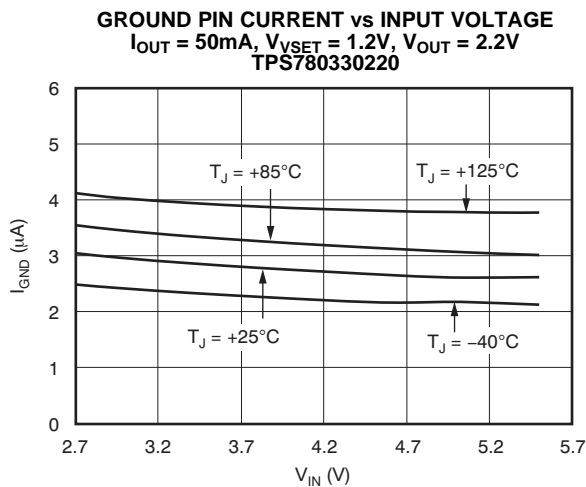

Figure 17.

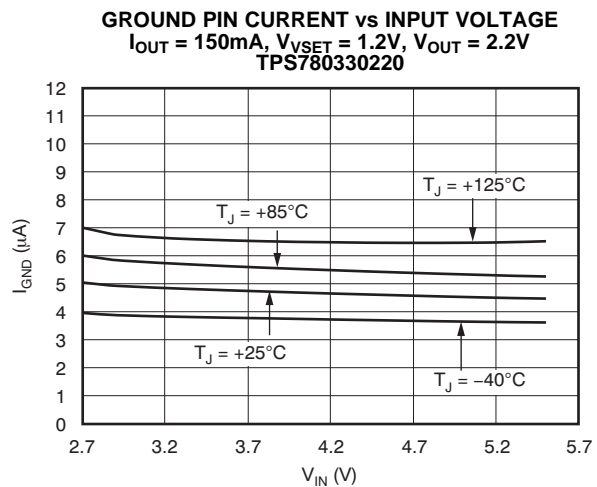

Figure 18.

TYPICAL CHARACTERISTICS (continued)

Over the operating temperature range of $T_J = -40^{\circ}\text{C}$ to $+125^{\circ}\text{C}$, $V_{IN} = V_{OUT(TYP)} + 0.5\text{V}$ or 2.2V , whichever is greater; $I_{OUT} = 100\mu\text{A}$, $V_{EN} = V_{VSET} = V_{IN}$, $C_{OUT} = 1\mu\text{F}$, and $C_{IN} = 1\mu\text{F}$, unless otherwise noted.

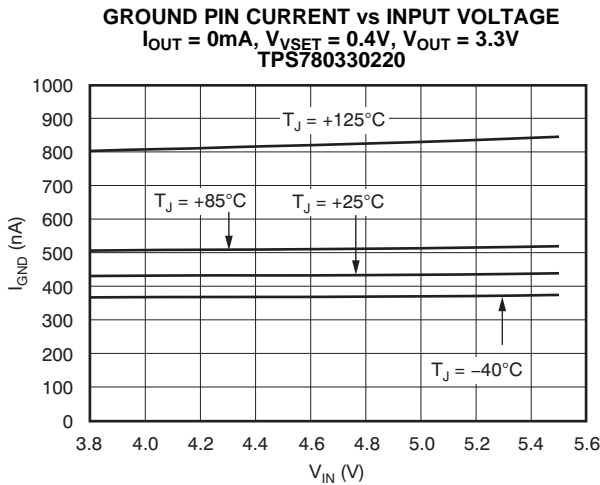

Figure 19.

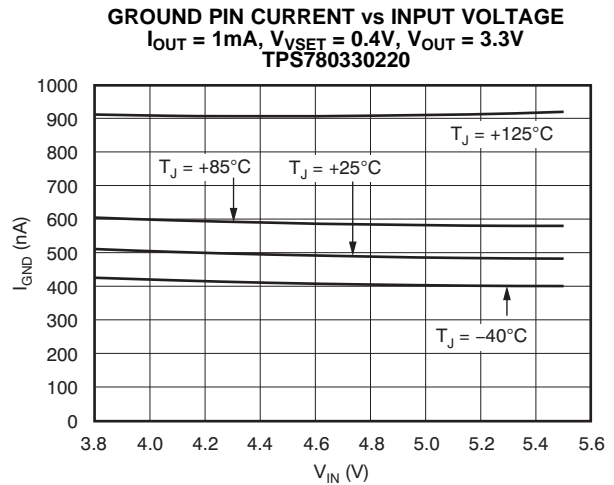

Figure 20.

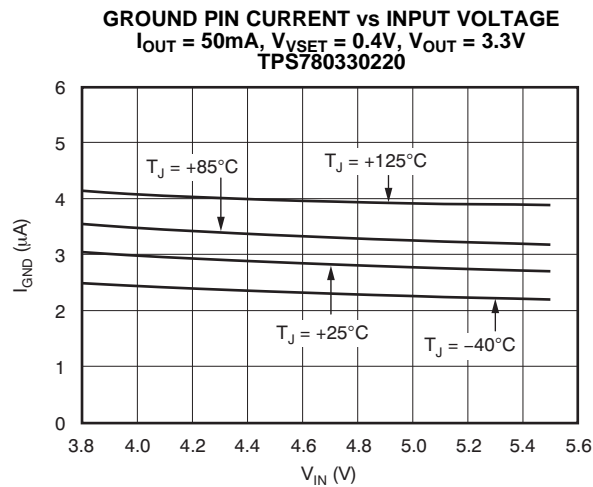

Figure 21.

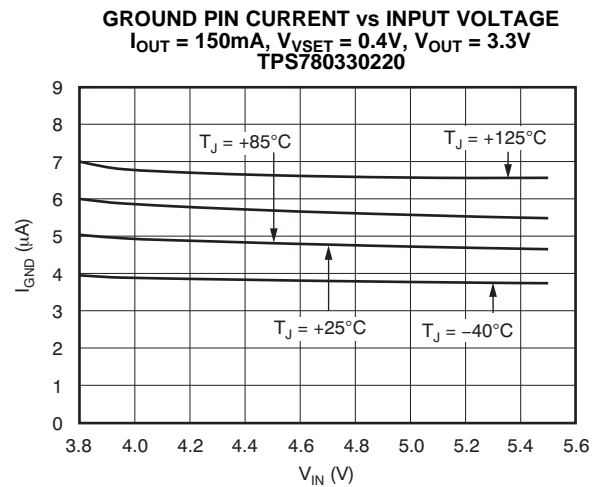

Figure 22.

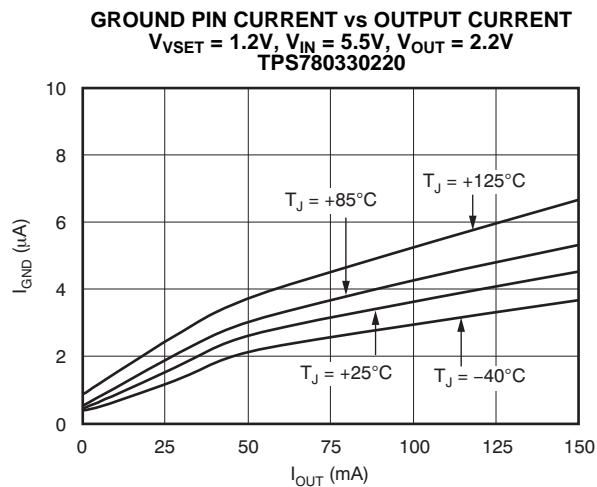

Figure 23.

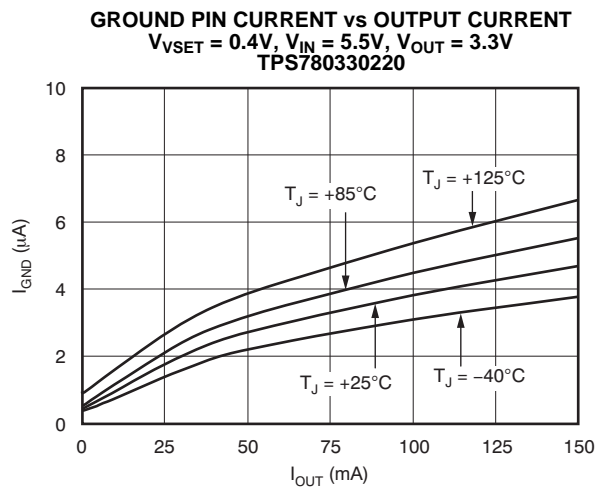

Figure 24.

TYPICAL CHARACTERISTICS (continued)

Over the operating temperature range of $T_J = -40^{\circ}\text{C}$ to $+125^{\circ}\text{C}$, $V_{IN} = V_{OUT(TYP)} + 0.5\text{V}$ or 2.2V , whichever is greater; $I_{OUT} = 100\mu\text{A}$, $V_{EN} = V_{VSET} = V_{IN}$, $C_{OUT} = 1\mu\text{F}$, and $C_{IN} = 1\mu\text{F}$, unless otherwise noted.

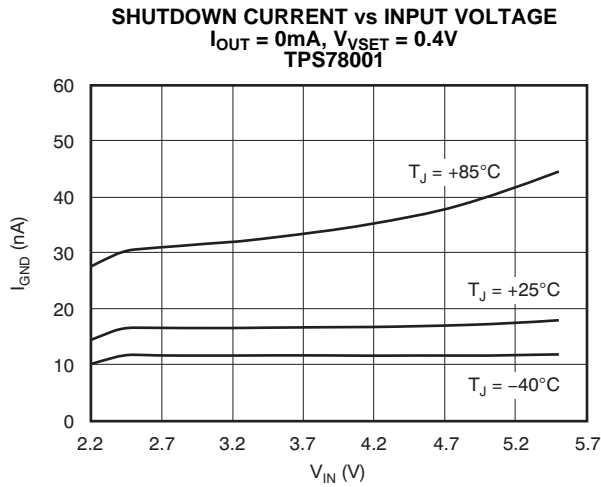

Figure 25.

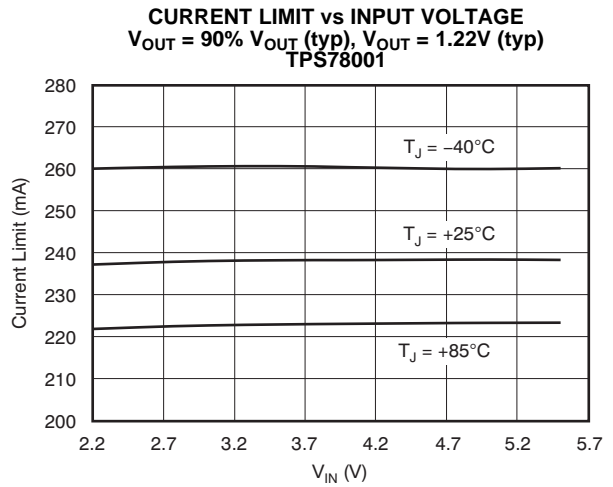

Figure 26.

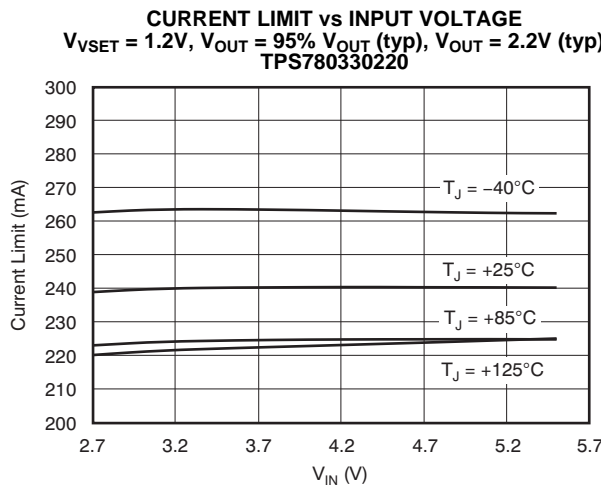

Figure 27.

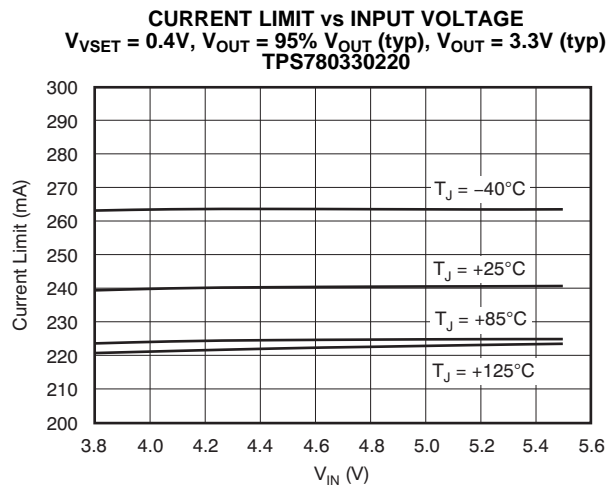

Figure 28.

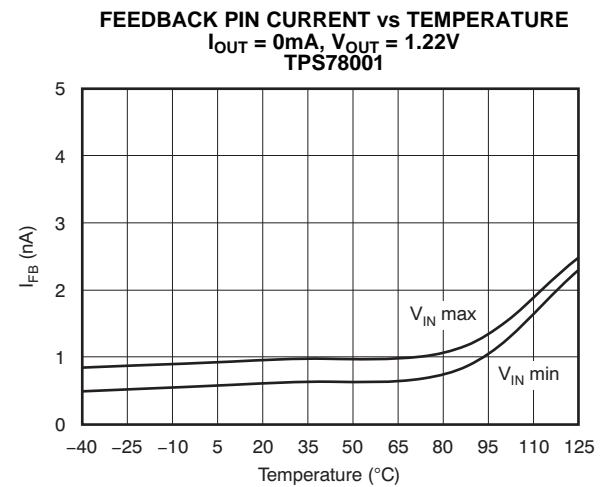

Figure 29.

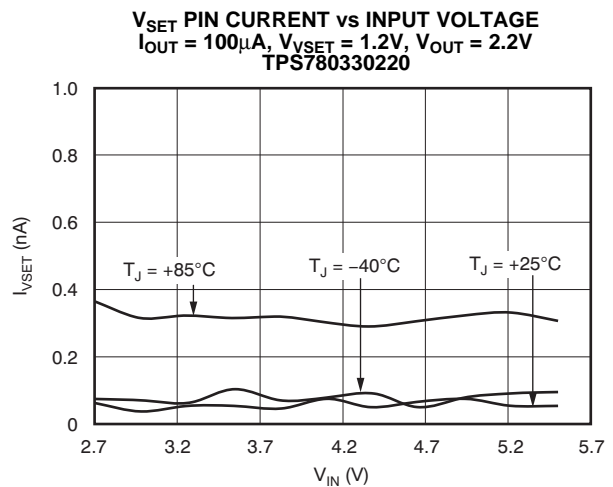

Figure 30.

TYPICAL CHARACTERISTICS (continued)

Over the operating temperature range of $T_J = -40^{\circ}\text{C}$ to $+125^{\circ}\text{C}$, $V_{IN} = V_{OUT(TYP)} + 0.5\text{V}$ or 2.2V , whichever is greater; $I_{OUT} = 100\mu\text{A}$, $V_{EN} = V_{VSET} = V_{IN}$, $C_{OUT} = 1\mu\text{F}$, and $C_{IN} = 1\mu\text{F}$, unless otherwise noted.

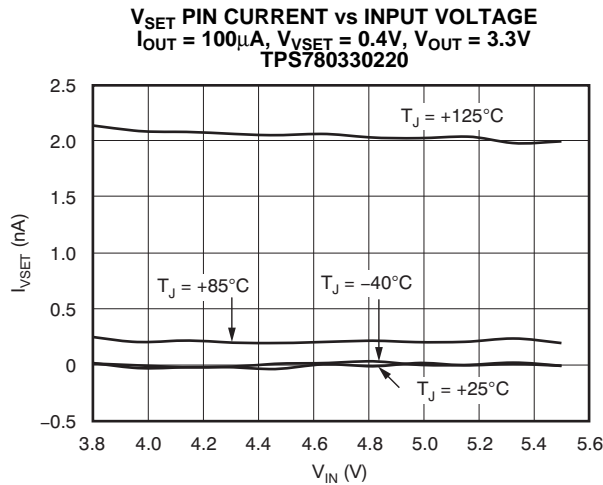

Figure 31.

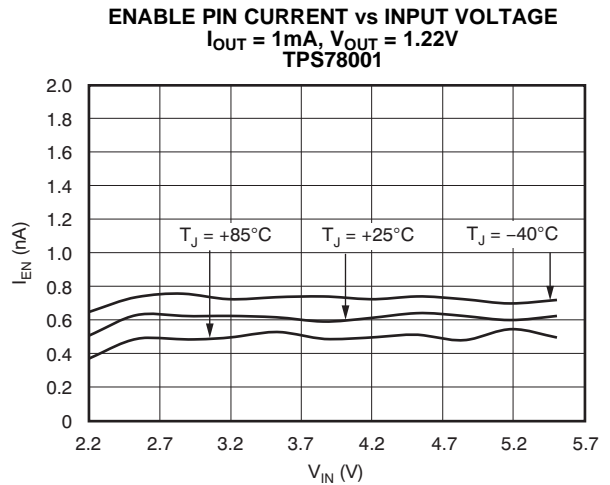

Figure 32.

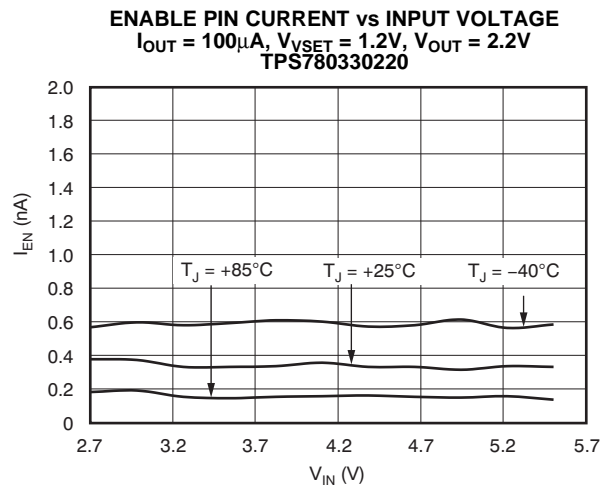

Figure 33.

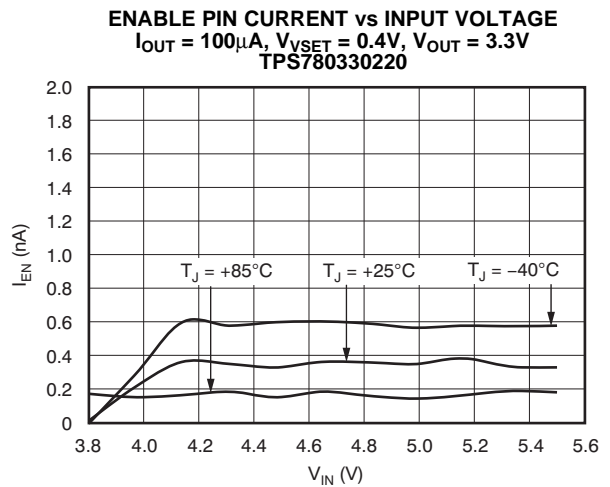

Figure 34.

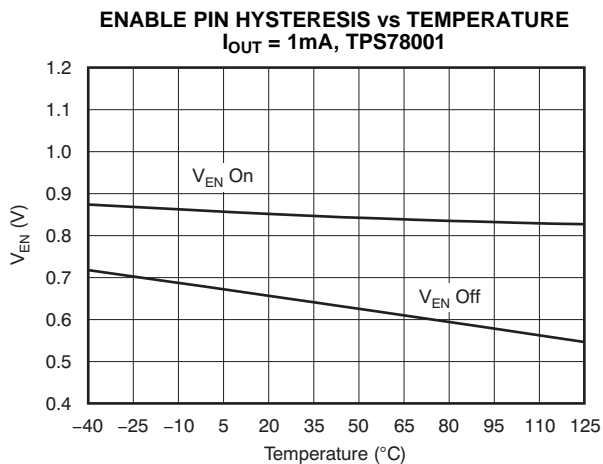

Figure 35.

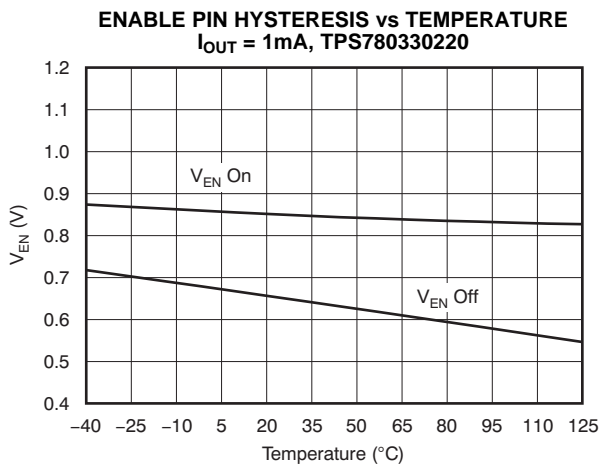

Figure 36.

TYPICAL CHARACTERISTICS (continued)

Over the operating temperature range of $T_J = -40^{\circ}\text{C}$ to $+125^{\circ}\text{C}$, $V_{IN} = V_{OUT(TYP)} + 0.5\text{V}$ or 2.2V , whichever is greater; $I_{OUT} = 100\mu\text{A}$, $V_{EN} = V_{VSET} = V_{IN}$, $C_{OUT} = 1\mu\text{F}$, and $C_{IN} = 1\mu\text{F}$, unless otherwise noted.

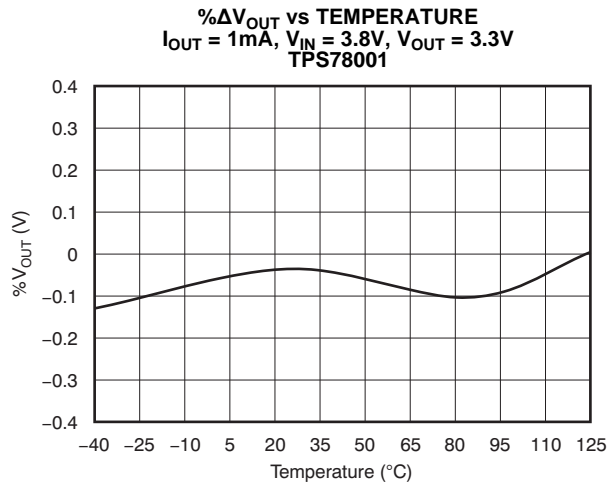

Figure 37.

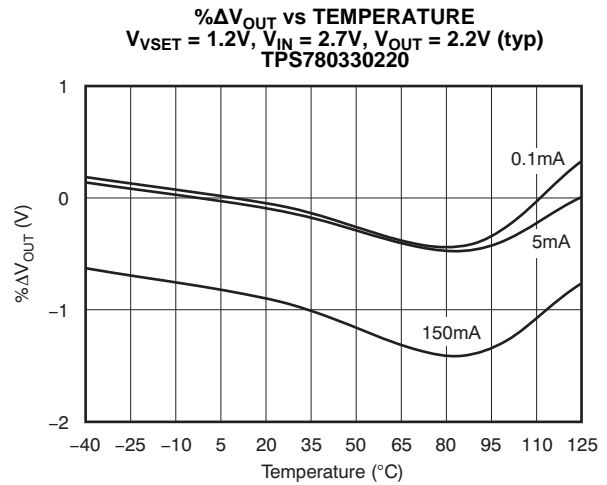

Figure 38.

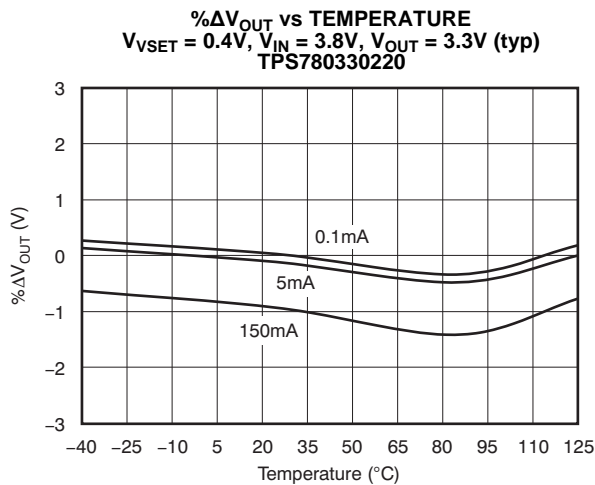

Figure 39.

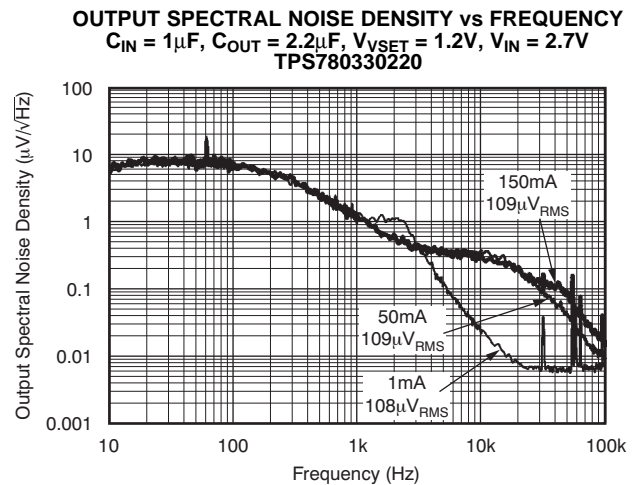

Figure 40.

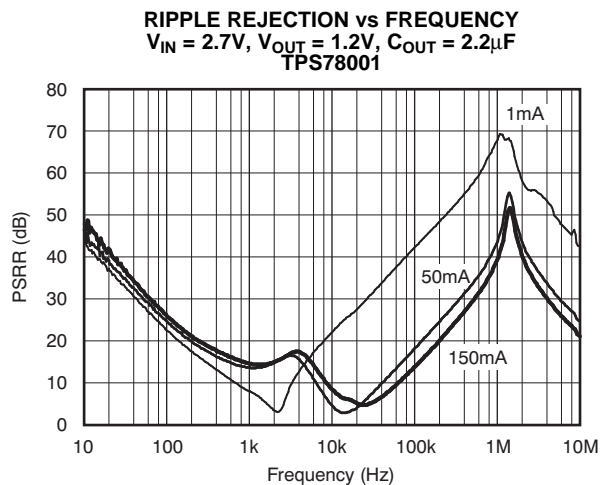

Figure 41.

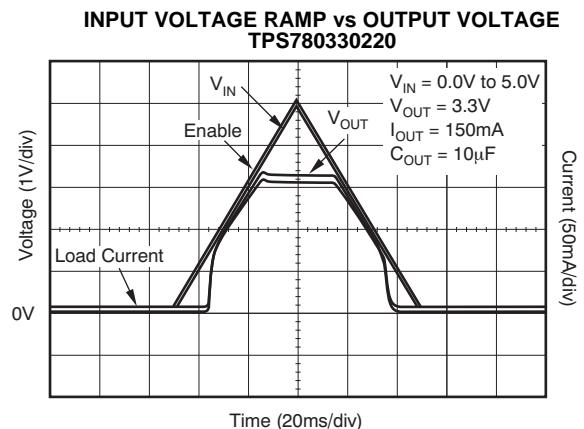

Figure 42.

TYPICAL CHARACTERISTICS (continued)

Over the operating temperature range of $T_J = -40^{\circ}\text{C}$ to $+125^{\circ}\text{C}$, $V_{IN} = V_{OUT(TYP)} + 0.5\text{V}$ or 2.2V , whichever is greater; $I_{OUT} = 100\mu\text{A}$, $V_{EN} = V_{VSET} = V_{IN}$, $C_{OUT} = 1\mu\text{F}$, and $C_{IN} = 1\mu\text{F}$, unless otherwise noted.

OUTPUT VOLTAGE vs ENABLE (SLOW RAMP)
TPS780330220

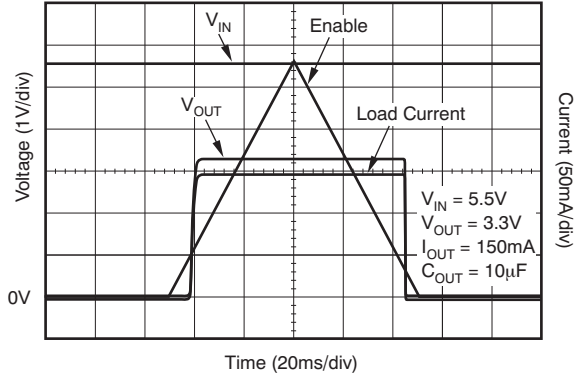

Figure 43.

INPUT VOLTAGE vs DELAY TO OUTPUT
TPS780330220

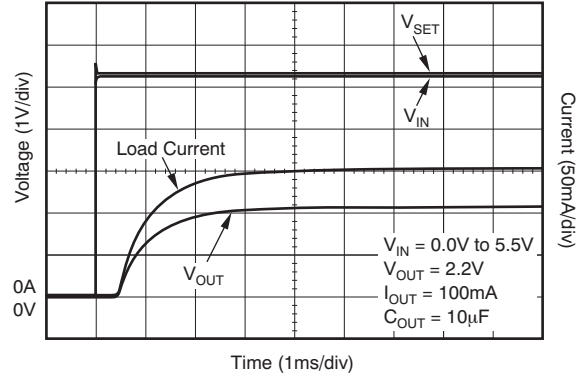

Figure 44.

LINE TRANSIENT RESPONSE
TPS780330220

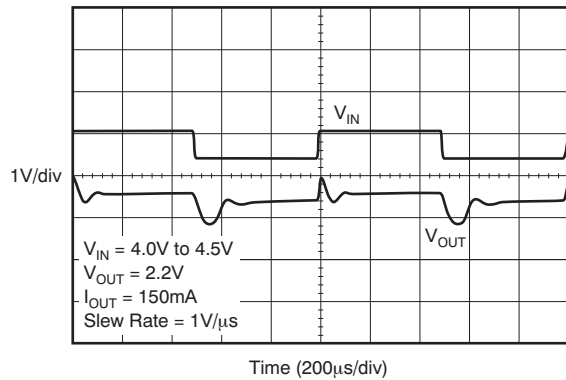

Figure 45.

LINE TRANSIENT RESPONSE
TPS780330220

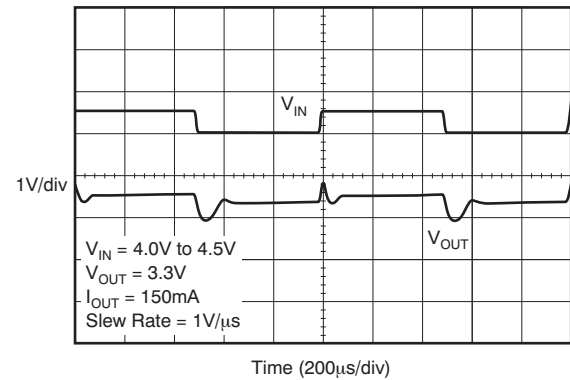

Figure 46.

LOAD TRANSIENT RESPONSE
TPS780330220

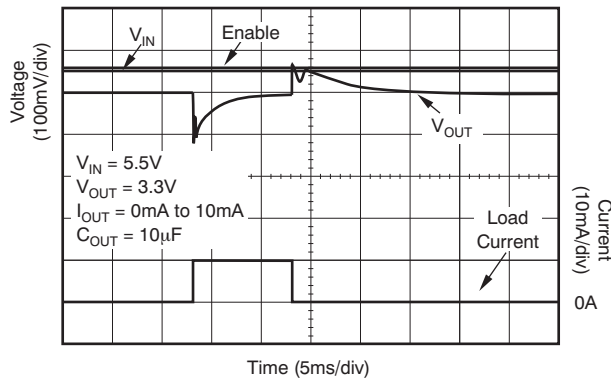

Figure 47.

LOAD TRANSIENT RESPONSE
TPS780330220

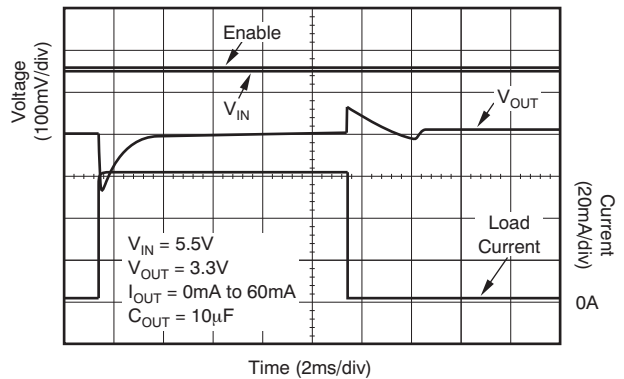

Figure 48.

TYPICAL CHARACTERISTICS (continued)

Over the operating temperature range of $T_J = -40^{\circ}\text{C}$ to $+125^{\circ}\text{C}$, $V_{IN} = V_{OUT(TYP)} + 0.5\text{V}$ or 2.2V , whichever is greater; $I_{OUT} = 100\mu\text{A}$, $V_{EN} = V_{VSET} = V_{IN}$, $C_{OUT} = 1\mu\text{F}$, and $C_{IN} = 1\mu\text{F}$, unless otherwise noted.

ENABLE PIN vs OUTPUT VOLTAGE RESPONSE AND OUTPUT CURRENT
TPS780330220

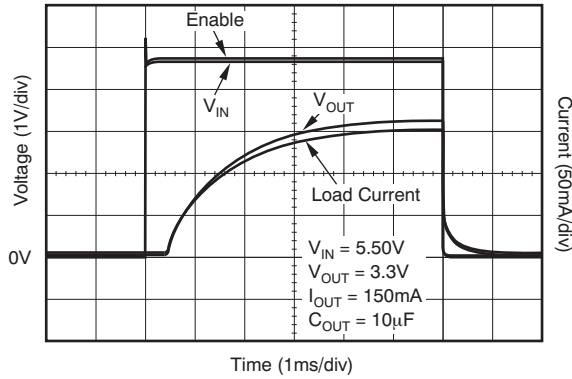

Figure 49.

ENABLE PIN vs OUTPUT VOLTAGE DELAY
TPS780330220

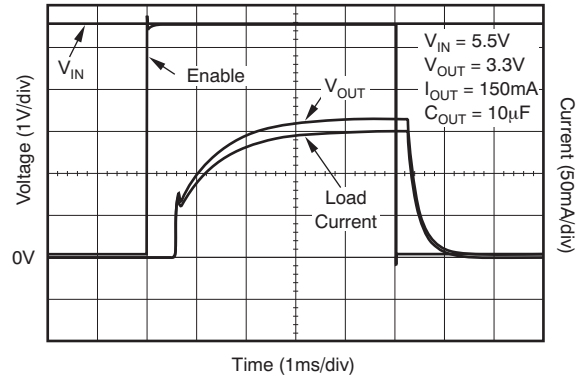

Figure 50.

V_{SET} PIN TOGGLE
TPS780330220

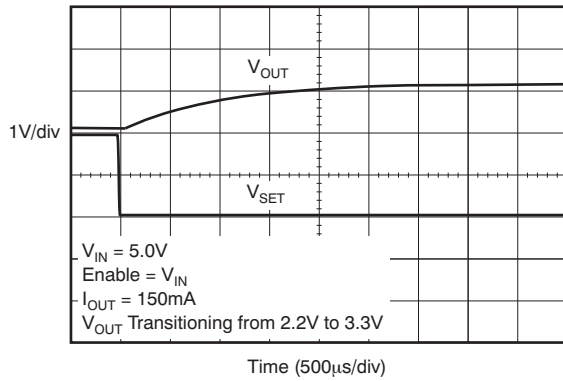

Figure 51.

V_{SET} PIN TOGGLE
TPS780330220

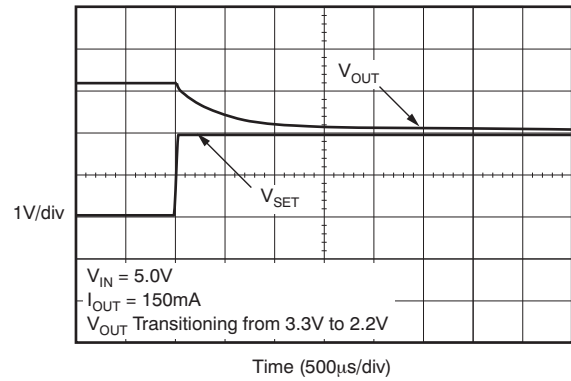

Figure 52.

V_{SET} PIN TOGGLE (SLOW RAMP)
TPS780330220

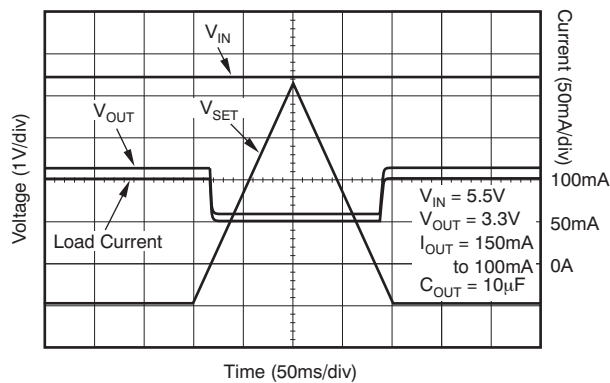

Figure 53.

APPLICATION INFORMATION

APPLICATION EXAMPLES

The TPS780 series of LDOs typically take less than 800µs to transition from a lower voltage of 2.2V to a higher voltage of 3.3V under an output load of 150mA; see Figure 51. Additionally, the TPS780 series contain active pull-down circuitry that automatically pulls charge out of the voltage capacitor to transition the output voltage from the higher voltage to the lower voltage, even with no load connected. Output voltage overshoots and undershoots are minimal under this load condition. The TPS780 series typically take less than 800µs to transition from V_{SET} low (3.3V to 2.2V), or V_{SET} high (2.2V to 3.3V); see Figure 51 and Figure 52. Both output states of the TPS780 series are factory-programmable between 1.5V to 4.2V. Note that during startup or steady-state conditions, it is important that the EN pin and V_{SET} pin voltages never exceed V_{IN} + 0.3V.

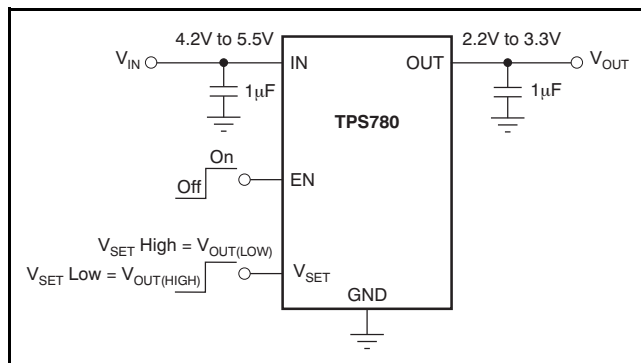

Figure 54. Typical Application Circuit

The TPS780 is also used effectively in dynamic voltage scaling (DVS) applications. DVS applications are required to dynamically switch between a high operational voltage to a low standby voltage in order to reduce power consumption. Modern multimillion gate microprocessors fabricated with the latest sub-micron processes save power by transitioning to a lower voltage to reduce leakage currents while maintaining content. This architecture enables the microprocessor to transition quickly into an operational state (wake up) without requiring a reload of the states from external memory, or a reboot.

Programming the TPS78001 Adjustable LDO Regulator

The output voltage of the TPS78001 adjustable regulator is programmed using an external resistor divider as shown in Figure 55. The output voltage operating range is 1.2V to 5.1V, and is calculated using Equation 1:

$$V_{OUT} = V_{FB} \times \left(1 + \frac{R_1}{R_2}\right) \tag{1}$$

Where:

V_{FB} = 1.216V typ (the internal reference voltage)

Resistors R₁ and R₂ should be chosen for approximately 1.2µA divider current. Lower value resistors can be used for improved noise performance, but the solution consumes more power. Higher resistor values should be avoided because leakage current into/out of FB across R₁/R₂ creates an offset voltage that artificially increases/decreases the feedback voltage and thus erroneously decreases/increases V_{OUT}. Table 2 lists several common output voltages and resistor values. The recommended design procedure is to choose R₂ = 1MΩ to set the divider current at 1.2µA, and then calculate R₁ using Equation 2:

$$R_1 = \left(\frac{V_{OUT}}{V_{FB}} - 1\right) \times R_2 \tag{2}$$

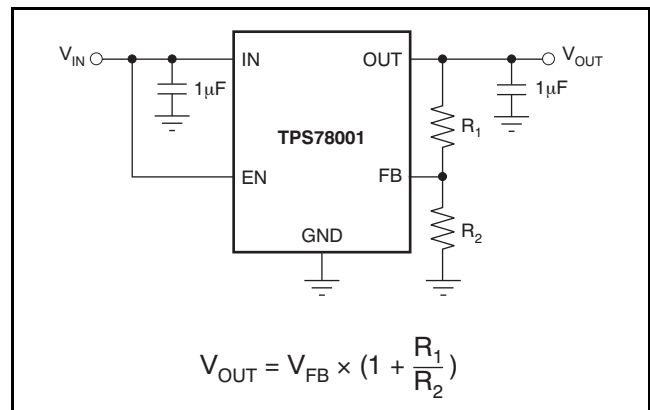

Figure 55. TPS78001 Adjustable LDO Regulator Programming

Table 2. Output Voltage Programming Guide

| OUTPUT VOLTAGE | R ₁ | R ₂ |
|----------------|----------------|----------------|
| 1.8V | 0.499MΩ | 1MΩ |
| 2.8V | 1.33MΩ | 1MΩ |
| 5.0V | 3.16MΩ | 1MΩ |

Powering the MSP430 Microcontroller

Several versions of the TPS780 are ideal for powering the MSP430 microcontroller. Table 3 shows potential applications of some voltage versions.

Table 3. Typical MSP430 Applications

| DEVICE | V _{OUT(HIGH)} (TYP) | V _{OUT(LOW)} (TYP) | APPLICATION |
|--------------|---------------------------------|--------------------------------|---|
| TPS780360200 | 3.6V | 2.0V | V _{OUT, MIN} > 1.800V required by many MSP430s. Allows lowest power consumption operation. |
| TPS780360220 | 3.6V | 2.2V | V _{OUT, MIN} > 2.200V required by some MSP430s FLASH operation. |
| TPS780360300 | 3.6V | 3.0V | V _{OUT, MIN} > 2.700V required by some MSP430s FLASH operation. |
| TPS780360220 | 3.6V | 2.2V | V _{OUT, MIN} < 3.600V required by some MSP430s. Allows highest speed operation. |

The TPS780 family offers many output voltage versions to allow designers to optimize the supply voltage for the processing speed required of the MSP430. This flexible architecture minimizes the supply current consumed by the particular MSP430 application. The MSP430 total system power can be reduced by substituting the 500nA I_Q TPS780 series LDO in place of an existing ultra-low I_Q LDO (typical best case = 1μA). Additionally, DVS allows for increasing the clock speed in active mode (MSP430 V_{CC} = 3.6V). The 3.6V V_{CC} reduces the MSP430 time in active mode. In low-power mode, MSP430 system power can be further reduced by lowering the MSP430 V_{CC} to 2.2V in sleep mode.

Key features of the TPS780 series are an ultralow quiescent current (500nA), DVS, and miniaturized packaging. The TPS780 family are available in SON-6 and TSOT-23 packages. Figure 56 shows a typical MSP430 circuit powered by an LDO without DVS. Figure 57 is an MSP430 circuit using a TPS780 LDO that incorporates an integrated DVS, thus simplifying the circuit design. In a circuit without DVS, as Figure 56 illustrates, V_{CC} is always at 3.0V. When the MSP430 goes into sleep mode, V_{CC} remains at 3.0V; if DVS is applied, V_{CC} could be reduced in sleep mode. In Figure 57, the TPS780 LDO with integrated DVS maintains 3.6V V_{CC} until a logic high signal from the MSP430 forces V_{OUT} to level shift V_{OUT} from 3.6V down to 2.2V, thus reducing power in sleep mode.

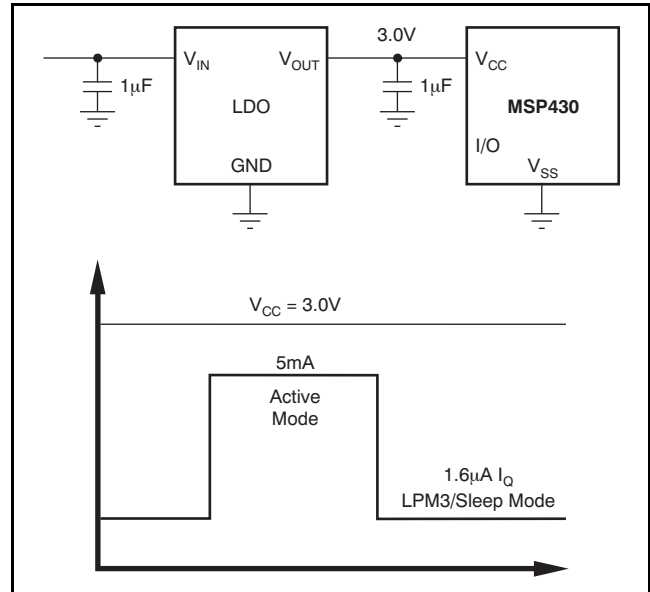

Figure 56. Typical LDO without DVS

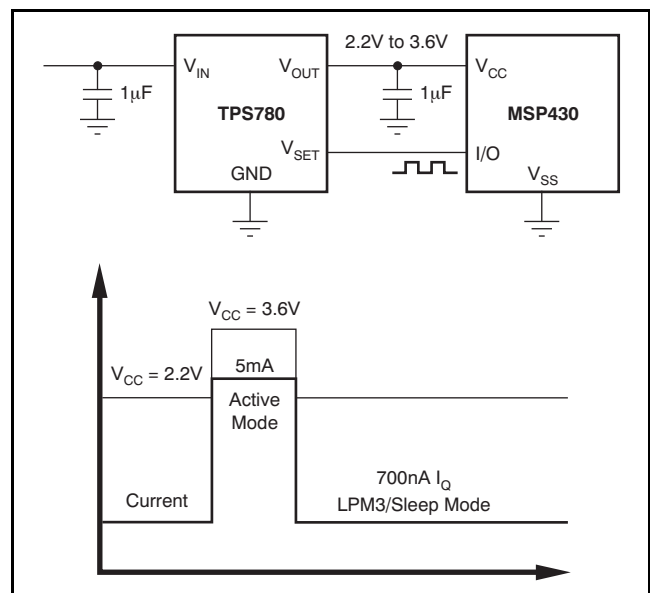

Figure 57. TPS780 with Integrated DVS

The other benefit of DVS is that it allows a higher V_{CC} voltage on the MSP430, increasing the clock speed and reducing the active mode dwell time.

The total system power savings is outlined in [Table 4](#), [Table 5](#), and [Table 6](#). In [Table 4](#), the MSP430 power savings are calculated for various MSP430 devices using a TPS780 series with integrated DVS versus a standard ultralow I_Q LDO without DVS. In [Table 5](#), the TPS780 series quiescent power is calculated for a V_{IN} of 4.2V, with the same V_{IN} used for the ultralow I_Q LDO. Quiescent power dissipation in an LDO is the V_{IN} voltage times the ground current, because zero load is applied. After the dissipation power is calculated for the individual LDOs in [Table 5](#), simple subtraction outputs the LDO power savings using the TPS780 series. [Table 6](#) calculates the total system power savings using a TPS780 series LDO in place of an ultralow I_Q 1.2 μ A LDO in an MSP430F1121 application. There are many different versions of the MSP430. Actual power savings will vary depending on the selected device.

INPUT AND OUTPUT CAPACITOR REQUIREMENTS

Although an input capacitor is not required for stability, it is good analog design practice to connect a 0.1 μ F to 1.0 μ F low equivalent series resistance (ESR) capacitor across the input supply near the regulator. This capacitor counteracts reactive input sources and improves transient response, noise rejection, and ripple rejection. A higher-value

capacitor may be necessary if large, fast rise-time load transients are anticipated, or if the device is not located near the power source. If source impedance is not sufficiently low, a 0.1 μ F input capacitor may be necessary to ensure stability.

The TPS780 is designed to be stable with standard ceramic capacitors with values of 1.0 μ F or larger at the output. X5R- and X7R-type capacitors are best because they have minimal variation in value and ESR over temperature. Maximum ESR should be less than 1.0 Ω . With tolerance and dc bias effects, the minimum capacitance required to ensure stability is 1 μ F.

BOARD LAYOUT RECOMMENDATIONS TO IMPROVE PSRR AND NOISE PERFORMANCE

To improve ac performance (such as PSRR, output noise, and transient response), it is recommended that the printed circuit board (PCB) be designed with separate ground planes for V_{IN} and V_{OUT} , with each ground plane connected only at the GND pin of the device. In addition, the ground connection for the output capacitor should connect directly to the GND pin of the device. High ESR capacitors may degrade PSRR.

Table 4. DVS MSP430 Power Savings with the TPS780 Series on selected MSP430 Devices

| DEVICE | LPM3 AT $V_{CC} = 3V$, I_Q (μ A) | LPM3 AT $V_{CC} = 3.0V$ $\times I_Q$ (μ W) | LPM3 AT $V_{CC} = 2.2V$, I_Q (μ A) | LPM3 AT $V_{CC} = 2.2V$ $\times I_Q$ (μ W) | μ W SAVINGS USING ONLY DVS |
|-------------|---|--|--|--|--------------------------------|
| MSP430F1121 | 1.6 | 4.8 | 0.7 | 1.5 | 3.3 |
| MSP430F149 | 1.6 | 4.8 | 0.9 | 2.0 | 2.8 |
| MSP430F2131 | 0.9 | 2.7 | 0.7 | 1.5 | 1.2 |
| MSP430F249 | 1.0 | 3.0 | 0.9 | 2.0 | 1.0 |
| MSP430F413 | 0.9 | 2.7 | 0.7 | 1.5 | 1.2 |
| MSP430F449 | 1.6 | 4.8 | 1.1 | 2.4 | 2.4 |

Table 5. Typical Ultralow I_Q LDO Quiescent Power Dissipation Versus the TPS780 Series

| TYPICAL ULTRALOW I_Q LDO AT +25°C AMBIENT | TYPICAL ULTRALOW I_Q LDO AT +25°C AMBIENT POWER DISSIPATION | TPS780 SERIES TYPICAL I_Q AT +25°C AMBIENT | TPS780 SERIES AT +25°C AMBIENT, POWER DISSIPATION | MSP430 SYSTEM POWER SAVINGS USING THE TPS780 SERIES |
|---|---|--|---|---|
| I_Q (μ A) | $I_Q \times V_{IN} = 4.2V$ (μ W) | TPS780 I_Q (μ A) | $I_Q \times V_{IN} = 4.2V$ (μ W) | QUIESCENT POWER DISSIPATION SAVINGS (μ W) |
| 1.20 | 5.04 | 0.42 | 1.76 | 3.28 |

Table 6. Total System Power Dissipation

| | LDO DISSIPATION | MSP430 DISSIPATION | TOTAL SYSTEM POWER IN SLEEP MODE 3 |
|---------------------------------|-----------------|----------------------------|------------------------------------|
| Typical 1.2 μ A LDO, no DVS | 5.04 μ W | 4.8 μ W ⁽¹⁾ | 9.84 μ W |
| TPS780 Series with DVS | 1.76 μ W | 1.5 μ W ⁽¹⁾ | 3.26 μ W |

(1) Value taken from [Table 4](#) and relative to the MSP430F1121.

INTERNAL CURRENT LIMIT

The TPS780 series are internally current-limited to protect the regulator during fault conditions. During current limit, the output sources a fixed amount of current that is largely independent of output voltage. For reliable operation, the device should not be operated in a current limit state for extended periods of time.

The PMOS pass element in the TPS780 series has a built-in body diode that conducts current when the voltage at OUT exceeds the voltage at IN. This current is not limited, so if extended reverse voltage operation is anticipated, external limiting to 5% of rated output current may be appropriate.

SHUTDOWN

The enable pin (EN) is active high and is compatible with standard and low-voltage CMOS levels. When shutdown capability is not required, EN should be connected to the IN pin, as shown in Figure 58. Figure 59 shows both EN and V_{SET} connected to IN. The TPS780 series, with internal active output pull-down circuitry, discharges the output to within 5% V_{OUT} with a time (t) shown in Equation 3:

$$t = 3 \left[\frac{10\text{k}\Omega \times R_L}{10\text{k}\Omega + R_L} \right] \times C_{OUT} \quad (3)$$

Where:

R_L = output load resistance

C_{OUT} = output capacitance

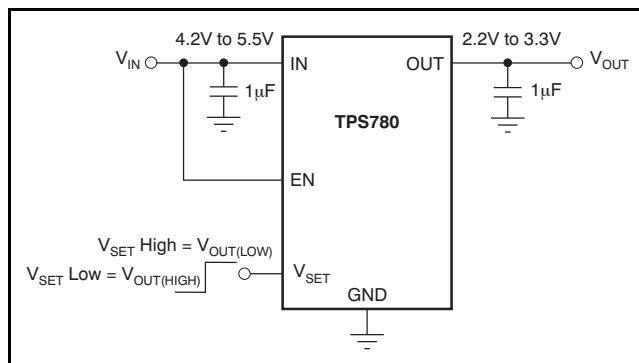

Figure 58. Circuit Showing EN Tied High when Shutdown Capability is Not Required

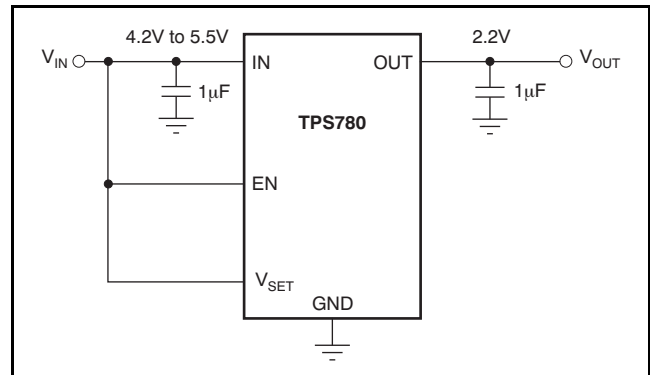

Figure 59. Circuit to Tie Both EN and V_{SET} High

DROPOUT VOLTAGE

The TPS780 series use a PMOS pass transistor to achieve low dropout. When (V_{IN} – V_{OUT}) is less than the dropout voltage (V_{DO}), the PMOS pass device is the linear region of operation and the input-to-output resistance is the R_{DS(ON)} of the PMOS pass element. V_{DO} approximately scales with output current because the PMOS device behaves like a resistor in dropout. As with any linear regulator, PSRR and transient response are degraded as (V_{IN} – V_{OUT}) approaches dropout. This effect is shown in the Typical Characteristics section. Refer to application report [SLVA207, Understanding LDO Dropout](#), available for download from [www.ti.com](#).

TRANSIENT RESPONSE

As with any regulator, increasing the size of the output capacitor reduces over/undershoot magnitude but increases duration of the transient response. For more information, see Figure 48.

ACTIVE V_{OUT} PULL-DOWN

In the TPS780 series, the active pull-down discharges V_{OUT} when the device is off. However, the input voltage must be greater than 2.2V for the active pull-down to work.

MINIMUM LOAD

The TPS780 series are stable with no output load. Traditional PMOS LDO regulators suffer from lower loop gain at very light output loads. The TPS780 series employ an innovative, low-current circuit under very light or no-load conditions, resulting in improved output voltage regulation performance down to zero output current. See Figure 47 for the load transient response.

THERMAL INFORMATION

THERMAL PROTECTION

Thermal protection disables the output when the junction temperature rises to approximately +160°C, allowing the device to cool. Once the junction temperature cools to approximately +140°C, the output circuitry is enabled. Depending on power dissipation, thermal resistance, and ambient temperature, the thermal protection circuit may cycle on and off again. This cycling limits the dissipation of the regulator, protecting it from damage as a result of overheating.

Any tendency to activate the thermal protection circuit indicates excessive power dissipation or an inadequate heatsink. For reliable operation, junction temperature should be limited to +125°C maximum. To estimate the margin of safety in a complete design (including heatsink), increase the ambient temperature until the thermal protection is triggered; use worst-case loads and signal conditions. For good reliability, thermal protection should trigger at least +35°C above the maximum expected ambient condition of your particular application. This configuration produces a worst-case junction temperature of +125°C at the highest expected ambient temperature and worst-case load.

The internal protection circuitry of the TPS780 series has been designed to protect against overload conditions. However, it is not intended to replace proper heatsinking. Continuously running the TPS780 series into thermal shutdown degrades device reliability.

POWER DISSIPATION

The ability to remove heat from the die is different for each package type, presenting different considerations in the PCB layout. The PCB area around the device that is free of other components moves the heat from the device to the ambient air. Performance data for JEDEC low- and high-K boards are given in the [Dissipation Ratings](#) table. Using heavier copper increases the effectiveness in removing heat from the device. The addition of plated through-holes to heat-dissipating layers also improves the heatsink effectiveness. Power dissipation depends on input voltage and load conditions. Power dissipation (P_D) is equal to the product of the output current times the voltage drop across the output pass element (V_{IN} to V_{OUT}), as shown in [Equation 4](#):

$$P_D = (V_{IN} - V_{OUT}) \times I_{OUT} \quad (4)$$

PACKAGE MOUNTING

Solder pad footprint recommendations for the TPS780 series are available from the Texas Instruments web site at www.ti.com through the [TPS780 series product folders](#).

PACKAGING INFORMATION

| Orderable Device | Status ⁽¹⁾ | Package Type | Package Drawing | Pins | Package Qty | Eco Plan ⁽²⁾ | Lead/ Ball Finish | MSL Peak Temp ⁽³⁾ | Samples (Requires Login) |
|--------------------|-----------------------|--------------|-----------------|------|-------------|----------------------------|----------------------|------------------------------|-----------------------------|
| TPS78001DDCR | ACTIVE | SOT | DDC | 5 | 3000 | Green (RoHS & no Sb/Br) | CU NIPDAU | Level-2-260C-1 YEAR | |
| TPS78001DDCRG4 | ACTIVE | SOT | DDC | 5 | 3000 | Green (RoHS & no Sb/Br) | CU NIPDAU | Level-2-260C-1 YEAR | |
| TPS78001DDCT | ACTIVE | SOT | DDC | 5 | 250 | Green (RoHS & no Sb/Br) | CU NIPDAU | Level-2-260C-1 YEAR | |
| TPS78001DDCTG4 | ACTIVE | SOT | DDC | 5 | 250 | Green (RoHS & no Sb/Br) | CU NIPDAU | Level-2-260C-1 YEAR | |
| TPS78001DRVR | ACTIVE | SON | DRV | 6 | 3000 | Green (RoHS & no Sb/Br) | CU NIPDAU | Level-1-260C-UNLIM | |
| TPS78001DRVRG4 | ACTIVE | SON | DRV | 6 | 3000 | Green (RoHS & no Sb/Br) | CU NIPDAU | Level-1-260C-UNLIM | |
| TPS78001DRVT | ACTIVE | SON | DRV | 6 | 250 | Green (RoHS & no Sb/Br) | CU NIPDAU | Level-1-260C-UNLIM | |
| TPS78001DRVTG4 | ACTIVE | SON | DRV | 6 | 250 | Green (RoHS & no Sb/Br) | CU NIPDAU | Level-1-260C-UNLIM | |
| TPS780230300DRVR | ACTIVE | SON | DRV | 6 | 3000 | Green (RoHS & no Sb/Br) | CU NIPDAU | Level-1-260C-UNLIM | |
| TPS780230300DRVT | ACTIVE | SON | DRV | 6 | 250 | TBD | Call TI | Call TI | |
| TPS780270200DDCR | ACTIVE | SOT | DDC | 5 | 3000 | Green (RoHS & no Sb/Br) | CU NIPDAU | Level-2-260C-1 YEAR | |
| TPS780270200DDCRG4 | ACTIVE | SOT | DDC | 5 | 3000 | Green (RoHS & no Sb/Br) | CU NIPDAU | Level-2-260C-1 YEAR | |
| TPS780270200DDCT | ACTIVE | SOT | DDC | 5 | 250 | Green (RoHS & no Sb/Br) | CU NIPDAU | Level-2-260C-1 YEAR | |
| TPS780270200DDCTG4 | ACTIVE | SOT | DDC | 5 | 250 | Green (RoHS & no Sb/Br) | CU NIPDAU | Level-2-260C-1 YEAR | |
| TPS780300250DRVR | ACTIVE | SON | DRV | 6 | 3000 | Green (RoHS & no Sb/Br) | CU NIPDAU | Level-1-260C-UNLIM | |
| TPS780300250DRVT | ACTIVE | SON | DRV | 6 | 250 | Green (RoHS & no Sb/Br) | CU NIPDAU | Level-1-260C-UNLIM | |
| TPS780330220DDCR | ACTIVE | SOT | DDC | 5 | 3000 | Green (RoHS & no Sb/Br) | CU NIPDAU | Level-2-260C-1 YEAR | |

| Orderable Device | Status ⁽¹⁾ | Package Type | Package Drawing | Pins | Package Qty | Eco Plan ⁽²⁾ | Lead/ Ball Finish | MSL Peak Temp ⁽³⁾ | Samples (Requires Login) |
|--------------------|-----------------------|--------------|-----------------|------|-------------|-------------------------|----------------------|------------------------------|-----------------------------|
| TPS780330220DDCRG4 | ACTIVE | SOT | DDC | 5 | 3000 | Green (RoHS & no Sb/Br) | CU NIPDAU | Level-2-260C-1 YEAR | |
| TPS780330220DDCT | ACTIVE | SOT | DDC | 5 | 250 | Green (RoHS & no Sb/Br) | CU NIPDAU | Level-2-260C-1 YEAR | |
| TPS780330220DDCTG4 | ACTIVE | SOT | DDC | 5 | 250 | Green (RoHS & no Sb/Br) | CU NIPDAU | Level-2-260C-1 YEAR | |
| TPS780330220DRVR | ACTIVE | SON | DRV | 6 | 3000 | Green (RoHS & no Sb/Br) | CU NIPDAU | Level-1-260C-UNLIM | |
| TPS780330220DRVRG4 | ACTIVE | SON | DRV | 6 | 3000 | Green (RoHS & no Sb/Br) | CU NIPDAU | Level-1-260C-UNLIM | |
| TPS780330220DRVT | ACTIVE | SON | DRV | 6 | 250 | Green (RoHS & no Sb/Br) | CU NIPDAU | Level-1-260C-UNLIM | |
| TPS780330220DRVTG4 | ACTIVE | SON | DRV | 6 | 250 | Green (RoHS & no Sb/Br) | CU NIPDAU | Level-1-260C-UNLIM | |

⁽¹⁾ The marketing status values are defined as follows:

ACTIVE: Product device recommended for new designs.

LIFEBUY: TI has announced that the device will be discontinued, and a lifetime-buy period is in effect.

NRND: Not recommended for new designs. Device is in production to support existing customers, but TI does not recommend using this part in a new design.

PREVIEW: Device has been announced but is not in production. Samples may or may not be available.

OBSOLETE: TI has discontinued the production of the device.

⁽²⁾ Eco Plan - The planned eco-friendly classification: Pb-Free (RoHS), Pb-Free (RoHS Exempt), or Green (RoHS & no Sb/Br) - please check <http://www.ti.com/productcontent> for the latest availability information and additional product content details.

TBD: The Pb-Free/Green conversion plan has not been defined.

Pb-Free (RoHS): TI's terms "Lead-Free" or "Pb-Free" mean semiconductor products that are compatible with the current RoHS requirements for all 6 substances, including the requirement that lead not exceed 0.1% by weight in homogeneous materials. Where designed to be soldered at high temperatures, TI Pb-Free products are suitable for use in specified lead-free processes.

Pb-Free (RoHS Exempt): This component has a RoHS exemption for either 1) lead-based flip-chip solder bumps used between the die and package, or 2) lead-based die adhesive used between the die and leadframe. The component is otherwise considered Pb-Free (RoHS compatible) as defined above.

Green (RoHS & no Sb/Br): TI defines "Green" to mean Pb-Free (RoHS compatible), and free of Bromine (Br) and Antimony (Sb) based flame retardants (Br or Sb do not exceed 0.1% by weight in homogeneous material)

⁽³⁾ MSL, Peak Temp. -- The Moisture Sensitivity Level rating according to the JEDEC industry standard classifications, and peak solder temperature.

Important Information and Disclaimer: The information provided on this page represents TI's knowledge and belief as of the date that it is provided. TI bases its knowledge and belief on information provided by third parties, and makes no representation or warranty as to the accuracy of such information. Efforts are underway to better integrate information from third parties. TI has taken and continues to take reasonable steps to provide representative and accurate information but may not have conducted destructive testing or chemical analysis on incoming materials and chemicals. TI and TI suppliers consider certain information to be proprietary, and thus CAS numbers and other limited information may not be available for release.

In no event shall TI's liability arising out of such information exceed the total purchase price of the TI part(s) at issue in this document sold by TI to Customer on an annual basis.

TAPE AND REEL INFORMATION

QUADRANT ASSIGNMENTS FOR PIN 1 ORIENTATION IN TAPE

*All dimensions are nominal

| Device | Package Type | Package Drawing | Pins | SPQ | Reel Diameter (mm) | Reel Width W1 (mm) | A0 (mm) | B0 (mm) | K0 (mm) | P1 (mm) | W (mm) | Pin1 Quadrant |
|------------------|--------------|-----------------|------|------|--------------------|--------------------|---------|---------|---------|---------|--------|---------------|
| TPS78001DDCR | SOT | DDC | 5 | 3000 | 179.0 | 8.4 | 3.2 | 3.2 | 1.4 | 4.0 | 8.0 | Q3 |
| TPS78001DDCT | SOT | DDC | 5 | 250 | 179.0 | 8.4 | 3.2 | 3.2 | 1.4 | 4.0 | 8.0 | Q3 |
| TPS78001DRVR | SON | DRV | 6 | 3000 | 179.0 | 8.4 | 2.2 | 2.2 | 1.2 | 4.0 | 8.0 | Q2 |
| TPS78001DRVT | SON | DRV | 6 | 250 | 179.0 | 8.4 | 2.2 | 2.2 | 1.2 | 4.0 | 8.0 | Q2 |
| TPS780230300DRVR | SON | DRV | 6 | 3000 | 179.0 | 8.4 | 2.2 | 2.2 | 1.2 | 4.0 | 8.0 | Q2 |
| TPS780270200DDCR | SOT | DDC | 5 | 3000 | 179.0 | 8.4 | 3.2 | 3.2 | 1.4 | 4.0 | 8.0 | Q3 |
| TPS780270200DDCT | SOT | DDC | 5 | 250 | 179.0 | 8.4 | 3.2 | 3.2 | 1.4 | 4.0 | 8.0 | Q3 |
| TPS780300250DRVR | SON | DRV | 6 | 3000 | 179.0 | 8.4 | 2.2 | 2.2 | 1.2 | 4.0 | 8.0 | Q2 |
| TPS780300250DRVT | SON | DRV | 6 | 250 | 179.0 | 8.4 | 2.2 | 2.2 | 1.2 | 4.0 | 8.0 | Q2 |
| TPS780330220DDCR | SOT | DDC | 5 | 3000 | 179.0 | 8.4 | 3.2 | 3.2 | 1.4 | 4.0 | 8.0 | Q3 |
| TPS780330220DDCT | SOT | DDC | 5 | 250 | 179.0 | 8.4 | 3.2 | 3.2 | 1.4 | 4.0 | 8.0 | Q3 |
| TPS780330220DRVR | SON | DRV | 6 | 3000 | 179.0 | 8.4 | 2.2 | 2.2 | 1.2 | 4.0 | 8.0 | Q2 |
| TPS780330220DRVT | SON | DRV | 6 | 250 | 179.0 | 8.4 | 2.2 | 2.2 | 1.2 | 4.0 | 8.0 | Q2 |

TAPE AND REEL BOX DIMENSIONS

*All dimensions are nominal

| Device | Package Type | Package Drawing | Pins | SPQ | Length (mm) | Width (mm) | Height (mm) |
|------------------|--------------|-----------------|------|------|-------------|------------|-------------|
| TPS78001DDCR | SOT | DDC | 5 | 3000 | 195.0 | 200.0 | 45.0 |
| TPS78001DDCT | SOT | DDC | 5 | 250 | 195.0 | 200.0 | 45.0 |
| TPS78001DRVR | SON | DRV | 6 | 3000 | 203.0 | 203.0 | 35.0 |
| TPS78001DRVT | SON | DRV | 6 | 250 | 203.0 | 203.0 | 35.0 |
| TPS780230300DRVR | SON | DRV | 6 | 3000 | 203.0 | 203.0 | 35.0 |
| TPS780270200DDCR | SOT | DDC | 5 | 3000 | 195.0 | 200.0 | 45.0 |
| TPS780270200DDCT | SOT | DDC | 5 | 250 | 195.0 | 200.0 | 45.0 |
| TPS780300250DRVR | SON | DRV | 6 | 3000 | 203.0 | 203.0 | 35.0 |
| TPS780300250DRVT | SON | DRV | 6 | 250 | 203.0 | 203.0 | 35.0 |
| TPS780330220DDCR | SOT | DDC | 5 | 3000 | 195.0 | 200.0 | 45.0 |
| TPS780330220DDCT | SOT | DDC | 5 | 250 | 195.0 | 200.0 | 45.0 |
| TPS780330220DRVR | SON | DRV | 6 | 3000 | 203.0 | 203.0 | 35.0 |
| TPS780330220DRVT | SON | DRV | 6 | 250 | 203.0 | 203.0 | 35.0 |

DDC (R-PDSO-G5)

PLASTIC SMALL-OUTLINE

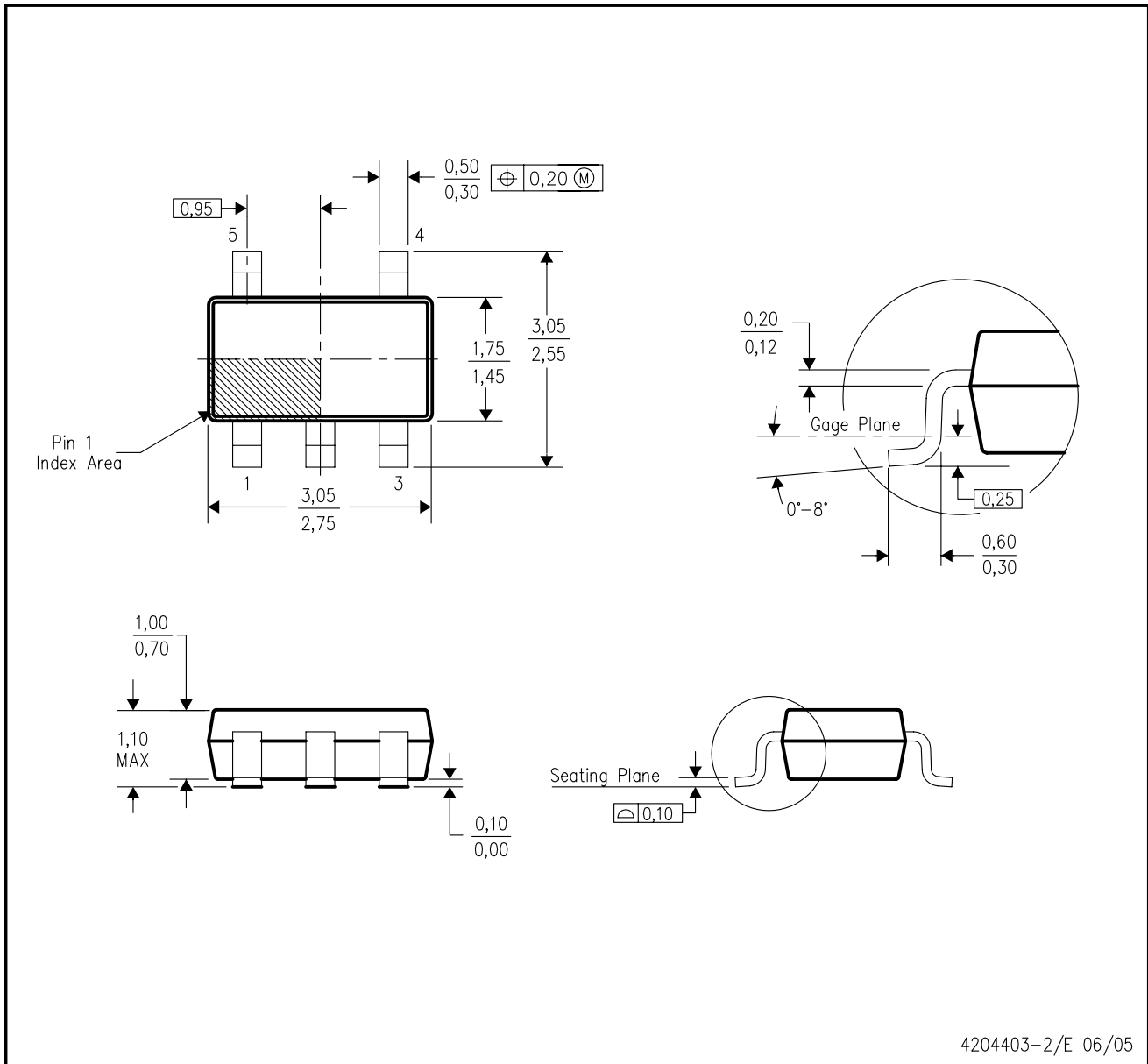

4204403-2/E 06/05

- NOTES:
- A. All linear dimensions are in millimeters.
 - B. This drawing is subject to change without notice.
 - C. Body dimensions do not include mold flash or protrusion.
 - D. Falls within JEDEC MO-193 variation AB (5 pin).

DRV (S-PWSON-N6)

PLASTIC SMALL OUTLINE NO-LEAD

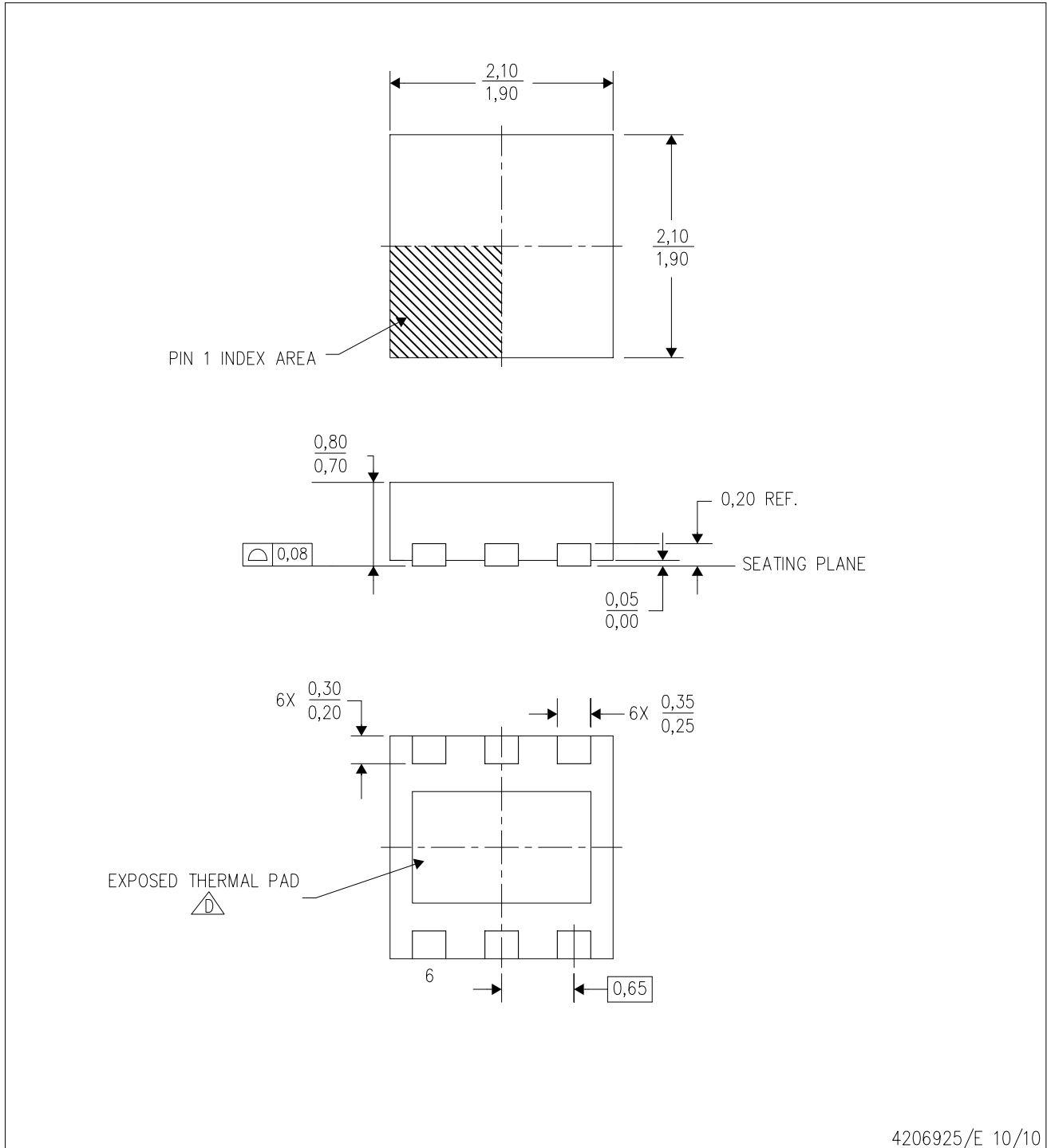

4206925/E 10/10

- NOTES:
- A. All linear dimensions are in millimeters. Dimensioning and tolerancing per ASME Y14.5M-1994.
 - B. This drawing is subject to change without notice.
 - C. Small Outline No-Lead (SON) package configuration.
 -  D. The package thermal pad must be soldered to the board for thermal and mechanical performance. See the Product Data Sheet for details regarding the exposed thermal pad dimensions.

IMPORTANT NOTICE

Texas Instruments Incorporated and its subsidiaries (TI) reserve the right to make corrections, modifications, enhancements, improvements, and other changes to its products and services at any time and to discontinue any product or service without notice. Customers should obtain the latest relevant information before placing orders and should verify that such information is current and complete. All products are sold subject to TI's terms and conditions of sale supplied at the time of order acknowledgment.

TI warrants performance of its hardware products to the specifications applicable at the time of sale in accordance with TI's standard warranty. Testing and other quality control techniques are used to the extent TI deems necessary to support this warranty. Except where mandated by government requirements, testing of all parameters of each product is not necessarily performed.

TI assumes no liability for applications assistance or customer product design. Customers are responsible for their products and applications using TI components. To minimize the risks associated with customer products and applications, customers should provide adequate design and operating safeguards.

TI does not warrant or represent that any license, either express or implied, is granted under any TI patent right, copyright, mask work right, or other TI intellectual property right relating to any combination, machine, or process in which TI products or services are used. Information published by TI regarding third-party products or services does not constitute a license from TI to use such products or services or a warranty or endorsement thereof. Use of such information may require a license from a third party under the patents or other intellectual property of the third party, or a license from TI under the patents or other intellectual property of TI.

Reproduction of TI information in TI data books or data sheets is permissible only if reproduction is without alteration and is accompanied by all associated warranties, conditions, limitations, and notices. Reproduction of this information with alteration is an unfair and deceptive business practice. TI is not responsible or liable for such altered documentation. Information of third parties may be subject to additional restrictions.

Resale of TI products or services with statements different from or beyond the parameters stated by TI for that product or service voids all express and any implied warranties for the associated TI product or service and is an unfair and deceptive business practice. TI is not responsible or liable for any such statements.

TI products are not authorized for use in safety-critical applications (such as life support) where a failure of the TI product would reasonably be expected to cause severe personal injury or death, unless officers of the parties have executed an agreement specifically governing such use. Buyers represent that they have all necessary expertise in the safety and regulatory ramifications of their applications, and acknowledge and agree that they are solely responsible for all legal, regulatory and safety-related requirements concerning their products and any use of TI products in such safety-critical applications, notwithstanding any applications-related information or support that may be provided by TI. Further, Buyers must fully indemnify TI and its representatives against any damages arising out of the use of TI products in such safety-critical applications.

TI products are neither designed nor intended for use in military/aerospace applications or environments unless the TI products are specifically designated by TI as military-grade or "enhanced plastic." Only products designated by TI as military-grade meet military specifications. Buyers acknowledge and agree that any such use of TI products which TI has not designated as military-grade is solely at the Buyer's risk, and that they are solely responsible for compliance with all legal and regulatory requirements in connection with such use.

TI products are neither designed nor intended for use in automotive applications or environments unless the specific TI products are designated by TI as compliant with ISO/TS 16949 requirements. Buyers acknowledge and agree that, if they use any non-designated products in automotive applications, TI will not be responsible for any failure to meet such requirements.

Following are URLs where you can obtain information on other Texas Instruments products and application solutions:

Products

| | |
|-----------------------------|--|
| Audio | www.ti.com/audio |
| Amplifiers | amplifier.ti.com |
| Data Converters | dataconverter.ti.com |
| DLP® Products | www.dlp.com |
| DSP | dsp.ti.com |
| Clocks and Timers | www.ti.com/clocks |
| Interface | interface.ti.com |
| Logic | logic.ti.com |
| Power Mgmt | power.ti.com |
| Microcontrollers | microcontroller.ti.com |
| RFID | www.ti-rfid.com |
| RF/IF and ZigBee® Solutions | www.ti.com/lprf |

Applications

| | |
|-------------------------------|--|
| Communications and Telecom | www.ti.com/communications |
| Computers and Peripherals | www.ti.com/computers |
| Consumer Electronics | www.ti.com/consumer-apps |
| Energy and Lighting | www.ti.com/energy |
| Industrial | www.ti.com/industrial |
| Medical | www.ti.com/medical |
| Security | www.ti.com/security |
| Space, Avionics and Defense | www.ti.com/space-avionics-defense |
| Transportation and Automotive | www.ti.com/automotive |
| Video and Imaging | www.ti.com/video |
| Wireless | www.ti.com/wireless-apps |

TI E2E Community Home Page

e2e.ti.com

Mailing Address: Texas Instruments, Post Office Box 655303, Dallas, Texas 75265
Copyright © 2011, Texas Instruments Incorporated