



# WS2818A

## Single-line 256 Gray-level 3-channel Constant Current LED Driver IC

### Features

- **5V application.**
- RGB output port withstand voltage 5V, DIN port withstand voltage 9V.
- Adopts the built-in signal reshaping circuit to achieve the signal waveform shaping, and thus no signal waveform distortion takes place.
- Built-in power-on reset and brown-out reset circuits.
- The gray levels of each pixel of 256 levels, and the refresh frequency reaches to 2KHz.
- Serial cascading interface, data receiving and decoding are all achieved by one signal line.
- Signal Break-point Continuous Transmission, any pixel's failure, it won't affect the whole display effect.
- The distance of any two signal transmission points is less than 5 meters, there's no extra circuits needed.
- When the refresh rate of 30fps, the cascade number are not less than 1024 pixels.
- Send data at speeds of 800Kbps.
- Good consistency reliability, high cost-effective.

### Applications

- Guardrail tube series, point light display series, flexible/rigid strips series, module series applications.
- Lighting stage costumes, innovative gadgets or any other electronic products.

### General description

WS2818A is a 3-channel LED driver control circuit, its internal include intelligent digital port data latch and signal reshaping amplification drive circuit. Also include a precision internal oscillator and a 12V voltage programmable constant current control part, which achieves highly consistent color effect.

WS2818A has strong features in Signal Break-point Continuous Transmission, it adopts **dual signal transmission**, these signals are able to work together without interaction. The user can select the first chip DIN/BIN as the control signal input pin, and the follow-up cascade chips will automatically identify the output signal released by the first chip which not to affect the whole display effect.

WS2818A adopts Single-line Return-to-Zero communication protocol. After the chip gets power-on reset, the DIN port receive data from controller, the first chip collects initial 24bit data then sent to the internal data latch, the other data which reshaping by the internal signal reshaping amplification circuit sent to the next cascade pixel through the DO port. The data reduced 24bit after transmitted through every pixel. Since WS2818 adopts auto-reshaping transmit technology, making the pixel cascade numbers are not limited to the signal transmission, but to signal transmission speed. When BIN works as control signal receiving interface, its control data is 24bit more than the DIN interface, so as to ensure that the two ways to control the number of pixels is the same

Based on the received 24bit data, the internal data latch generates different duty cycle control signals in the OUTF, OUTG, OUTB port. All chips synchronous send the received data to each segment when the DIN port input a reset signal. It will receive new data again After the reset signal finished. Before a new reset signal received, the control signal of OUTF, OUTG, OUTB pin unchanged. The chip exports PWM data to OUTF, OUTG, OUTB pins, after receive a low voltage reset signal the time retain over **280μs**.

*SOP8 and CPC8 packaging available for sale.*

### PIN configuration

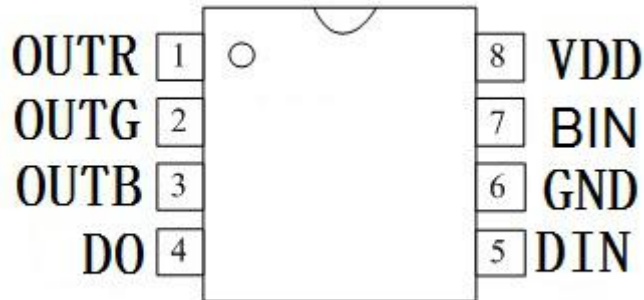

### PIN Function

NO.	Symbol	PIN	Function description
1	OUTR	LED Driver Output	Output of RED PWM control
2	OUTG	LED Driver Output	Output of GREEN PWM control
3	OUTB	LED Driver Output	Output of BLUE PWM control
4	DO	Data Output	Data cascade output
5	DIN	Data Input	Control data input
6	GND	Ground	Data & Power Grounding
7	BIN	Backup Data Input	Backup control data input
8	VDD	Power Voltage	IC power supply

### Absolute Maximum Ratings (T<sub>A</sub>=25°C, V<sub>SS</sub>=0V, unless otherwise noted.)

Parameter	Symbol	Ratings	Unit
Power Supply Voltage	V <sub>DD</sub>	+3.5~+5.3	V
Input Voltage	V <sub>I</sub>	-0.5~VDD+0.5	V
Operation Temperature	T <sub>opt</sub>	-25~+85	°C
Storage Temperature Range	T <sub>stg</sub>	-40~105	°C
R/G/B Channel Output Port Withstand Voltage	V <sub>out</sub>	7	V

**Electrical Characteristics** (TA=-20~+70°C, VDD=4.5~5.5V, VSS=0V unless otherwise noted.)

Parameter	Symbol	Min.	Tpy	Max.	Unit	Conditions
Low voltage output current	I <sub>OL</sub>	15.5	16.5	17.5	mA	
	I <sub>dout</sub>	10	—	—	mA	V <sub>o</sub> =0.4V, D <sub>OUT</sub>
Input current	I <sub>I</sub>	—	—	±1	μA	V <sub>I</sub> =V <sub>DD</sub> /V <sub>SS</sub>
High-level Input	V <sub>IH</sub>	0.7V <sub>DD</sub>	—	—	V	D <sub>IN</sub>
Low-level Input	V <sub>IL</sub>	—	—	0.3 V <sub>DD</sub>	V	D <sub>IN</sub>
Hysteresis Voltage	V <sub>H</sub>	—	0.35	—	V	D <sub>IN</sub>

**Switching Characteristics** (TA=-20~+70°C, VDD=4.5~5.5V, VSS=0V, unless otherwise noted.)

Parameter	Symbol	Min.	Tpy	Max.	Unit	Conditions
Transmission Delay Time	t <sub>PLZ</sub>	—	—	300	ns	CL=15pF, DIN→DOUT, RL=10KΩ
Fall Time	t <sub>THZ</sub>	—	—	120	μs	CL=300pF, OUTR/OUTG/OUTB
Data Transmission Rate	F <sub>MAX</sub>	400	—	—	Kbps	Duty Ratio 50%
Input-capacitance	C <sub>I</sub>	—	—	15	pF	—

### Sequence Time

T0H	0-code, High-level time	220ns~380ns
T1H	1-code, High-level time	580ns~1.6μs
T0L	0-code, Low-level time	580ns~1.6μs
T1L	1-code, Low-level time	220ns~420ns
RES	Frame unit, Low-level time	> 280μs

### Sequence Chart

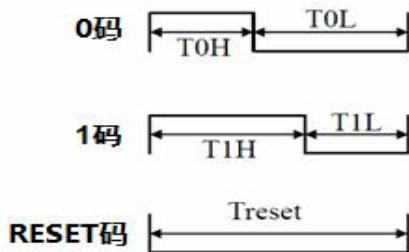

### Cascade Method

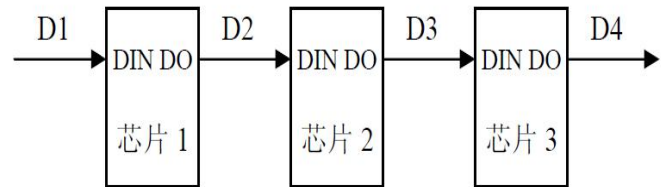

### Data Transmission Method

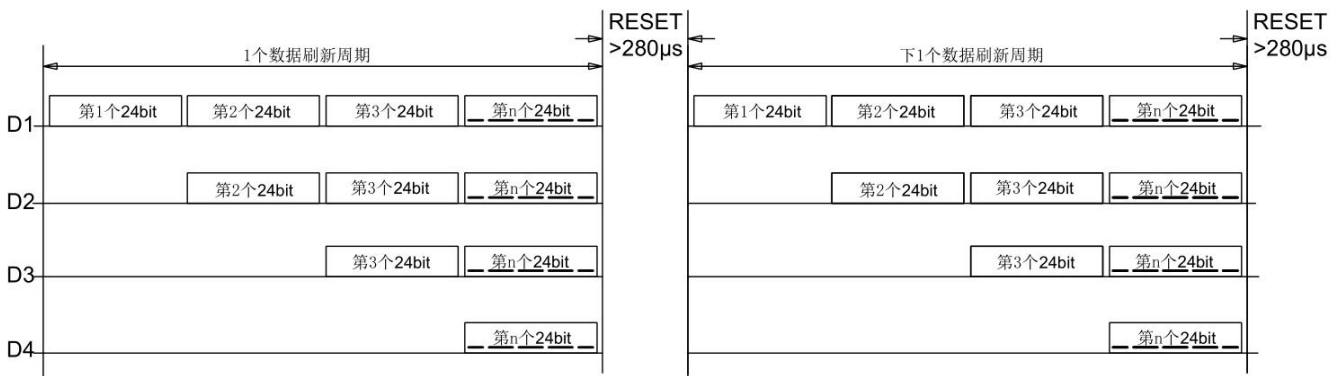

Note: D1 is the data from MCU, and D2, D3, D4 are from Cascade Circuits.

### Composition of 24bit data

R7	R6	R5	R4	R3	R2	R1	R0	G7	G6	G5	G4	G3	G2	G1	G0	B7	B6	B5	B4	B3	B2	B1	B0
----	----	----	----	----	----	----	----	----	----	----	----	----	----	----	----	----	----	----	----	----	----	----	----

Note: Data transmit in order of RGB, high bit data is first.

### Typical Application Circuit

\* Supply voltage=5V, 1 LED for each channel and Constant Current driving of 16.5mA

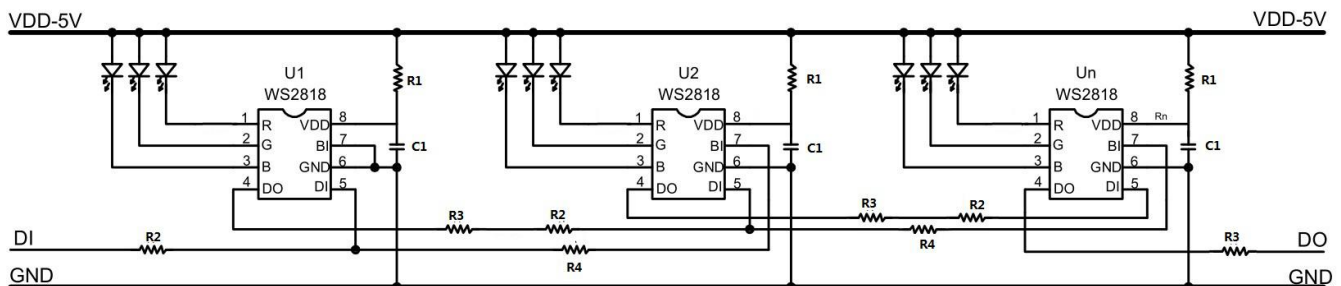

Remarks: This driving mode use constant current output, the advantage of is the LED can retain luminance and color temperature when the power supply lessen. We require, in order to prevent power spikes phenomenon and power reverse polarity, series with a resistor less than 100ohm connected with the power supply pin(VDD). The capacitance 104 as bypass capacitor. To prevent the reflection and hot-swap protection, we suggest to connect a 33ohm resistor at the data input or output port for impedance.

### Packaging Information

- SOP-8 Package

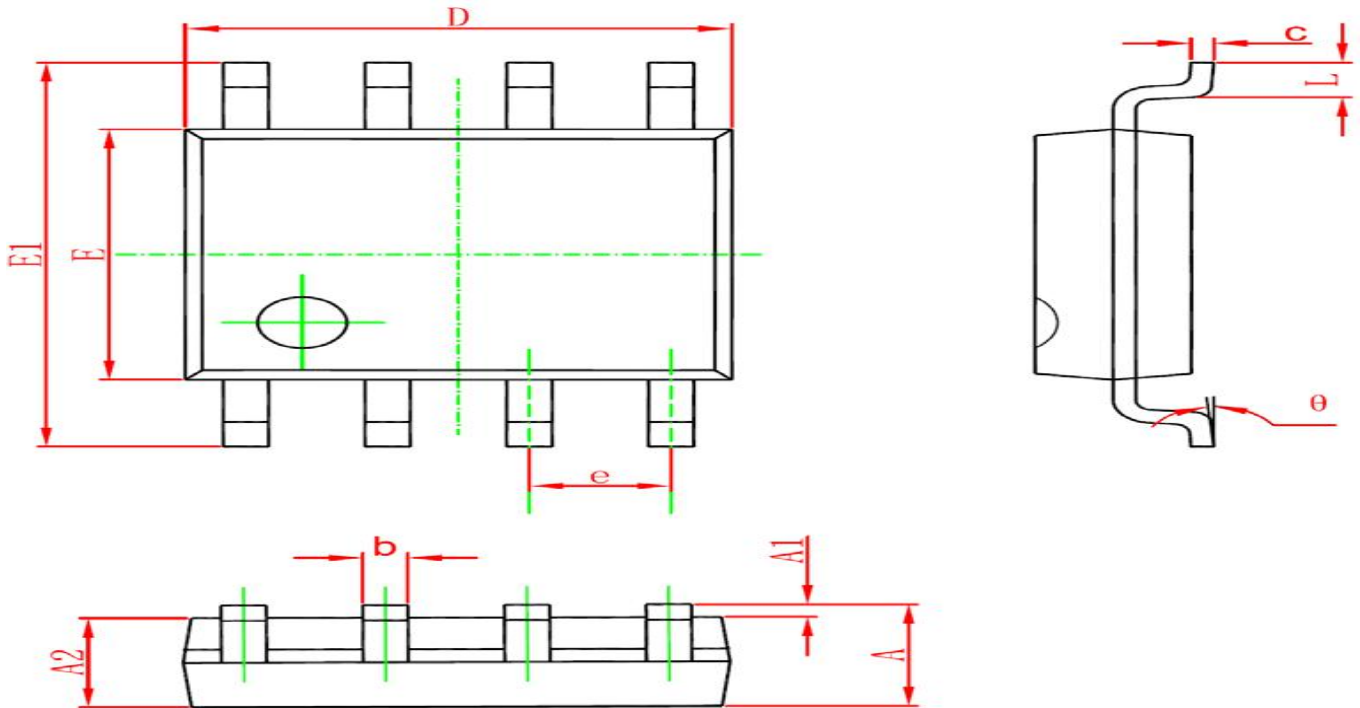

Symbol	Dimensions In Millimeters		Dimensions In Inches	
	Min	Max	Min	Max
A	1.350	1.750	0.053	0.069
A1	0.100	0.250	0.004	0.010
A2	1.350	1.550	0.053	0.061
b	0.330	0.510	0.013	0.020
c	0.170	0.250	0.006	0.010
D	4.700	5.100	0.185	0.200
E	3.800	4.000	0.150	0.157
E1	5.800	6.200	0.228	0.244
e	1.270		0.050	
L	0.400	1.270	0.016	0.050
θ	0°	8°	0°	8°

● **CPC8 Package**

尺寸 标注	最小(mm)	最大(mm)	尺寸 标注	最小(mm)	最大(mm)
A	2.50	2.70	C	0.85	1.05
A1	0.35	0.45	C1	0.00	0.15
e	0.53 (BSC)		C2	0.15	0.18
B	2.50	2.70	L	0.40	0.60
B1	3.85	4.15	$\theta$	0°	8°
b	0.16	0.26			

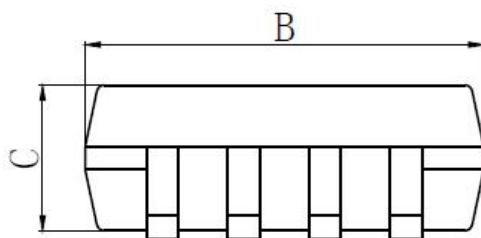
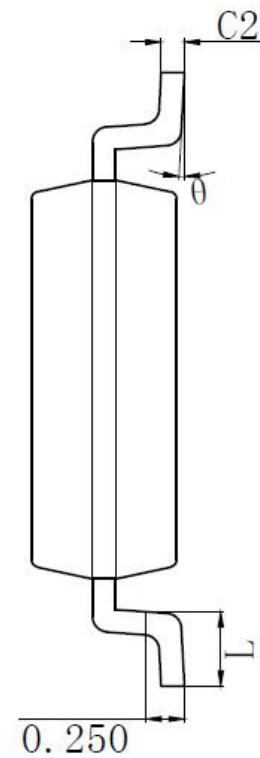
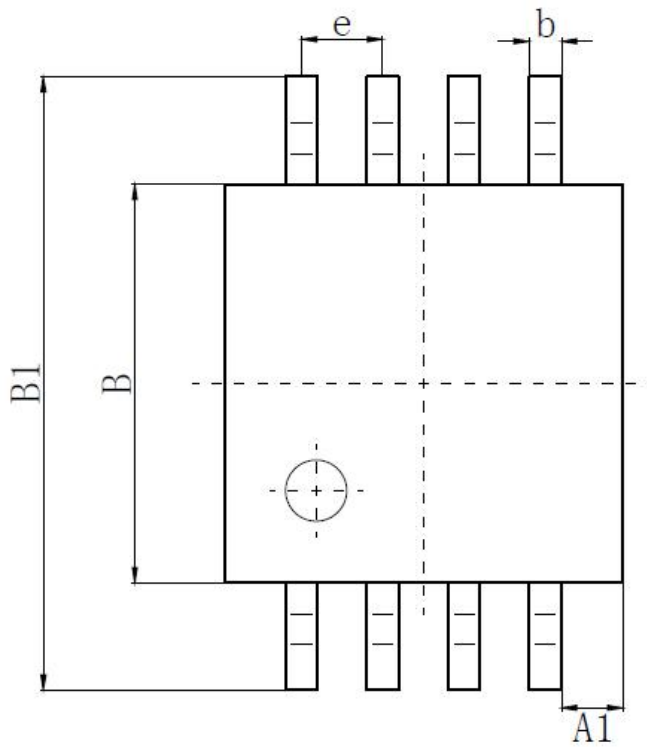



# WS2818A

## Single-line 256 Gray-level 3-channel Constant Current LED Driver IC

### Modify Records

Version №	Status Bar	Modify Content Summary	Date	Reviser	Approved
V1.0	N	New	20170523	Shen JinGuo	Yin HuaPing

Remarks: Initial version: V1.0; Version number plus "0.1" after each revision;

Status bar: N--New, A--Add, M--Modify, D--Delete.