



Power Mini SMD LED



19226

DESCRIPTION

The new MiniLED series has been designed in a small white SMT package. The feature of the device is the very small package 2.3 mm x 1.3 mm x 1.4 mm. The MiniLED is an obvious solution for small-scale, high-power products that are expected to work reliably in an arduous environment. This is often the case in automotive and industrial application.

PRODUCT GROUP AND PACKAGE DATA

- Product group: LED
- Package: SMD MiniLED
- Product series: power
- Angle of half intensity: $\pm 60^\circ$

FEATURES

- SMD LEDs with exceptional brightness
- Luminous intensity categorized
- Compatible with automatic placement equipment
- IR reflow soldering
- Available in 8 mm tape
- Low profile package
- Non-diffused lens: excellent for coupling to light pipes and backlighting
- Low power consumption
- Luminous intensity ratio in one packing unit $I_{Vmax}/I_{Vmin} \leq 1.6$
- AEC-Q101 qualified
- Material categorization: for definitions of compliance please see www.vishay.com/doc?99912



APPLICATIONS

- Automotive: backlighting in dashboards, and switches
- Telecommunication: indicator and backlighting in telephone and fax
- Indicator and backlight for audio and video equipment
- Indicator and backlight in office equipment
- Flat backlight for LCDs, switches, and symbols

PARTS TABLE														
PART	COLOR	LUMINOUS INTENSITY (mcd)			at I _F (mA)	WAVELENGTH (nm)			at I _F (mA)	FORWARD VOLTAGE (V)			at I _F (mA)	TECHNOLOGY
		MIN.	TYP.	MAX.		MIN.	TYP.	MAX.		MIN.	TYP.	MAX.		
VLMK23P2R1-GS08	Red	56	120	140	20	-	630	-	20	-	1.9	2.6	20	AllnGaP on GaAs
VLMK23Q2S1-GS08	Red	90	125	224	20	-	630	-	20	-	1.9	2.6	20	AllnGaP on GaAs
VLMK23P2S1-GS08	Red	56	125	224	20	-	630	-	20	-	1.9	2.6	20	AllnGaP on GaAs
VLMK23R1S1-GS08	Red	112	130	224	20	-	630	-	20	-	1.9	2.6	20	AllnGaP on GaAs
VLMF23Q2S1-GS08	Soft orange	90	180	224	20	598	605	611	20	-	2	2.6	20	AllnGaP on GaAs
VLMF23R2T1-GS08	Soft orange	140	180	355	20	598	605	611	20	-	2	2.6	20	AllnGaP on GaAs
VLMF23Q2T1-GS08	Soft orange	90	180	355	20	598	605	611	20	-	2	2.6	20	AllnGaP on GaAs
VLME23Q2S1-GS08	Yellow	90	170	224	20	581	588	594	20	-	2	2.6	20	AllnGaP on GaAs
VLME23R2T1-GS08	Yellow	140	190	355	20	581	588	594	20	-	2	2.6	20	AllnGaP on GaAs
VLME23Q2T1-GS08	Yellow	90	170	355	20	581	588	594	20	-	2	2.6	20	AllnGaP on GaAs



ABSOLUTE MAXIMUM RATINGS ($T_{amb} = 25\text{ }^{\circ}\text{C}$, unless otherwise specified) VLMK23.., VLMF23.., VLME23..				
PARAMETER	TEST CONDITION	SYMBOL	VALUE	UNIT
Reverse voltage ⁽¹⁾		V_R	5	V
DC Forward current	$T_{amb} \leq 80\text{ }^{\circ}\text{C}$	I_F	30	mA
Surge forward current	$t_p \leq 10\text{ }\mu\text{s}$	I_{FSM}	0.1	A
Power dissipation		P_V	80	mW
Junction temperature		T_j	+125	$^{\circ}\text{C}$
Operating temperature range		T_{amb}	-40 to +100	$^{\circ}\text{C}$
Storage temperature range		T_{stg}	-40 to +100	$^{\circ}\text{C}$
Thermal resistance junction / ambient	Mounted on PC board (pad size > 5 mm ²)	R_{thJA}	580	K/W

Note

⁽¹⁾ Driving the LED in reverse direction is suitable for a short term application

OPTICAL AND ELECTRICAL CHARACTERISTICS ($T_{amb} = 25\text{ }^{\circ}\text{C}$, unless otherwise specified) VLMK23.., RED							
PARAMETER	TEST CONDITION	PART	SYMBOL	MIN.	TYP.	MAX.	UNIT
Luminous intensity ⁽¹⁾	$I_F = 20\text{ mA}$	VLMK23P2R1	I_V	56	120	140	mcd
		VLMK23Q2S1	I_V	90	125	224	mcd
		VLMK23P2S1	I_V	56	125	224	mcd
		VLMK23R1S1	I_V	112	130	224	mcd
Dominant wavelength	$I_F = 20\text{ mA}$		λ_d	-	630	-	nm
Peak wavelength	$I_F = 20\text{ mA}$		λ_p	-	643	-	nm
Angle of half intensity	$I_F = 20\text{ mA}$		φ	-	± 60	-	deg
Forward voltage	$I_F = 20\text{ mA}$		V_F	-	1.9	2.6	V
Reverse voltage	$I_R = 10\text{ }\mu\text{A}$		V_R	5	-	-	V
Junction capacitance	$V_R = 0\text{ V}$, $f = 1\text{ MHz}$		C_j	-	15	-	pF

Note

⁽¹⁾ In one packing unit $I_{Vmax}/I_{Vmin} \leq 1.6$

OPTICAL AND ELECTRICAL CHARACTERISTICS ($T_{amb} = 25\text{ }^{\circ}\text{C}$, unless otherwise specified) VLMF23.., SOFT ORANGE							
PARAMETER	TEST CONDITION	PART	SYMBOL	MIN.	TYP.	MAX.	UNIT
Luminous intensity ⁽¹⁾	$I_F = 20\text{ mA}$	VLMF23Q2S1	I_V	90	180	224	mcd
		VLMF23R2T1	I_V	140	180	355	mcd
		VLMF23Q2T1	I_V	90	180	355	mcd
Dominant wavelength	$I_F = 20\text{ mA}$		λ_d	598	605	611	nm
Peak wavelength	$I_F = 20\text{ mA}$		λ_p	-	610	-	nm
Angle of half intensity	$I_F = 20\text{ mA}$		φ	-	± 60	-	deg
Forward voltage	$I_F = 20\text{ mA}$		V_F	-	2	2.6	V
Reverse voltage	$I_R = 10\text{ }\mu\text{A}$		V_R	5	-	-	V
Junction capacitance	$V_R = 0\text{ V}$, $f = 1\text{ MHz}$		C_j	-	15	-	pF

Note

⁽¹⁾ In one packing unit $I_{Vmax}/I_{Vmin} \leq 1.6$

**OPTICAL AND ELECTRICAL CHARACTERISTICS** ($T_{amb} = 25\text{ }^{\circ}\text{C}$, unless otherwise specified)
VLME23.., YELLOW

PARAMETER	TEST CONDITION	PART	SYMBOL	MIN.	TYP.	MAX.	UNIT
Luminous intensity ⁽¹⁾	$I_F = 20\text{ mA}$	VLME23Q2S1	I_V	90	170	224	mcd
		VLME23R2T1	I_V	140	190	355	mcd
		VLME23Q2T1	I_V	90	170	355	mcd
Dominant wavelength	$I_F = 20\text{ mA}$		λ_d	581	588	594	nm
Peak wavelength	$I_F = 20\text{ mA}$		λ_p	-	590	-	nm
Angle of half intensity	$I_F = 20\text{ mA}$		ϕ	-	± 60	-	deg
Forward voltage	$I_F = 20\text{ mA}$		V_F	-	2	2.6	V
Reverse voltage	$I_R = 10\text{ }\mu\text{A}$		V_R	5	-	-	V
Junction capacitance	$V_R = 0\text{ V}$, $f = 1\text{ MHz}$		C_j		15	-	pF

Note

⁽¹⁾ In one packing unit $I_{Vmax}/I_{Vmin.} \leq 1.6$

LUMINOUS INTENSITY CLASSIFICATION

GROUP	LIGHT INTENSITY (mcd)			
	STANDARD	OPTIONAL	MIN.	MAX.
P	2	56	71	
Q	1	71	90	
	2	90	112	
R	1	112	140	
	2	140	180	
S	1	180	224	
	2	224	280	
T	1	280	355	

Note

- Luminous intensity is tested at a current pulse duration of 25 ms and an accuracy of $\pm 11\%$.
The above type numbers represent the order groups which include only a few brightness groups. Only one group will be shipped on each reel (there will be no mixing of two groups on each reel).
In order to ensure availability, single brightness groups will not be orderable.
In a similar manner for colors where wavelength groups are measured and binned, single wavelength groups will be shipped on any one reel.
In order to ensure availability, single wavelength groups will not be orderable.

COLOR CLASSIFICATION

GROUP	DOMINANT WAVELENGTH (nm)			
	SOFT ORANGE		YELLOW	
	MIN.	MAX.	MIN.	MAX.
1	598	601	581	584
2	600	603	583	586
3	602	605	585	588
4	604	607	587	590
5	606	609	589	592
6	608	611	591	594

Note

- Wavelengths are tested at a current pulse duration of 25 ms.

CROSSING TABLE

VISHAY	OSRAM
VLME23Q2S1	LYM676Q2S1
VLME23R2T1	LYM676R2T1
VLME23Q2T1	LYM676Q2T1
VLMF23Q2S1	LOM676Q2S1
VLMF23R2T1	LOM676R2T1
VLMF23Q2T1	LOM676Q2T1
VLMK23P2R1	LSM676P2R1
VLMK23Q2S1	LSM676Q2S1
VLMK23P2S1	LSM676P2S1

TYPICAL CHARACTERISTICS ($T_{amb} = 25\text{ }^{\circ}\text{C}$, unless otherwise specified)

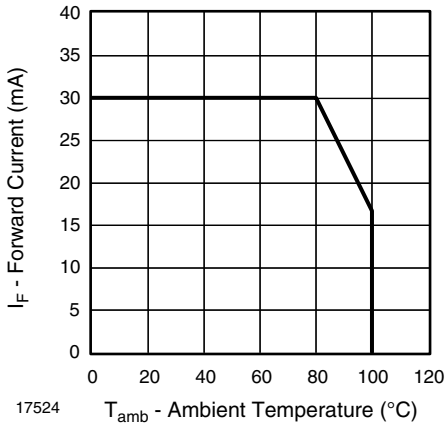

Fig. 1 - Forward Current vs. Ambient Temperature

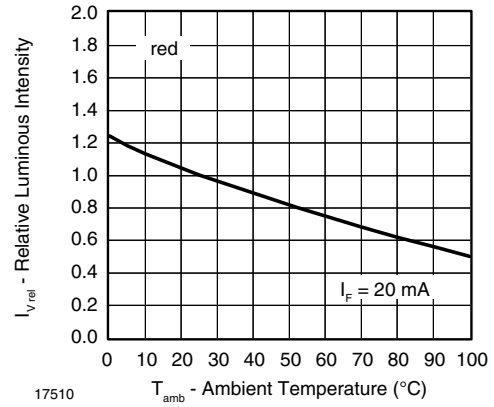

Fig. 4 - Relative Luminous Intensity vs. Ambient Temperature

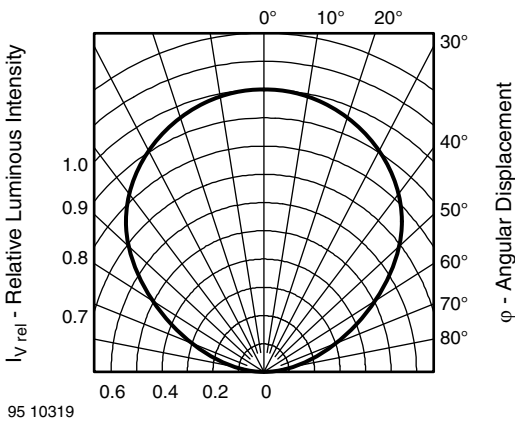

Fig. 2 - Relative Luminous Intensity vs. Angular Displacement

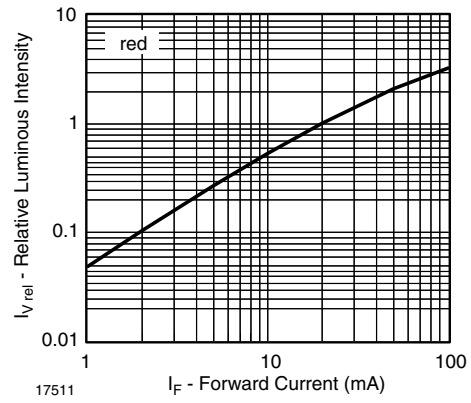

Fig. 5 - Relative Luminous Intensity vs. Forward Current

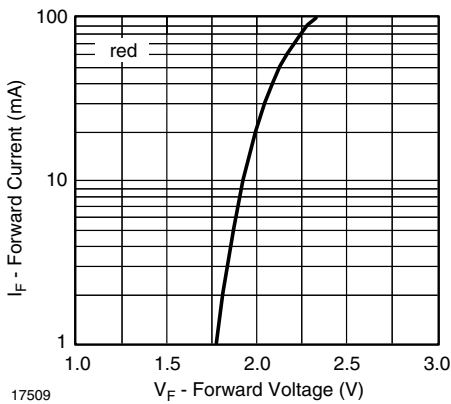

Fig. 3 - Forward Current vs. Forward Voltage

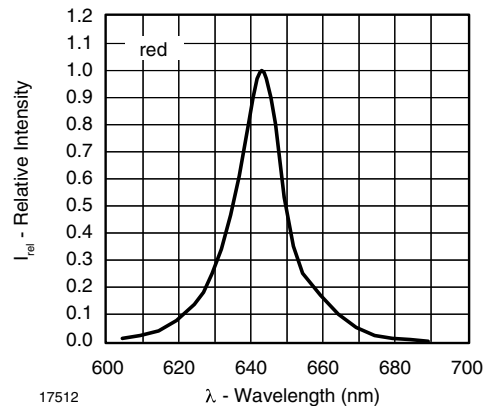

Fig. 6 - Relative Intensity vs. Wavelength

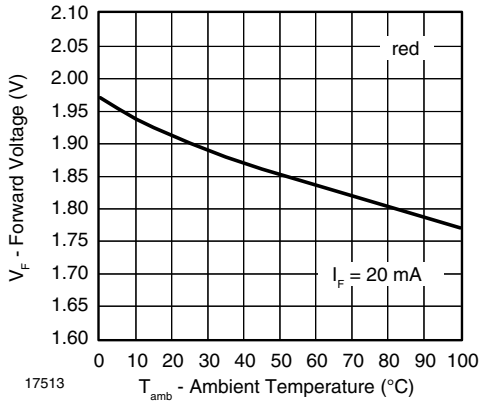

Fig. 7 - Relative Intensity vs. Wavelength



Fig. 10 - Relative Luminous Intensity vs. Forward Current

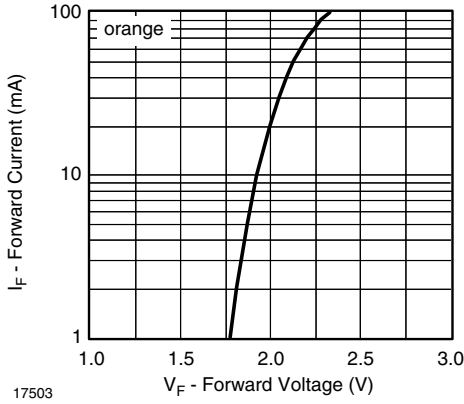

Fig. 8 - Forward Current vs. Forward Voltage



Fig. 11 - Relative Intensity vs. Wavelength

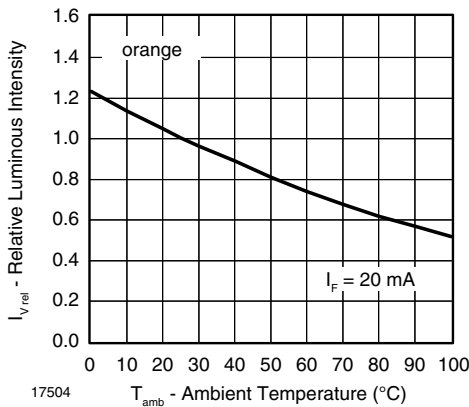

Fig. 9 - Relative Luminous Intensity vs. Ambient Temperature

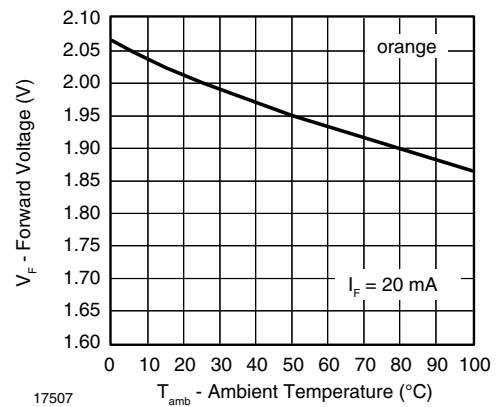

Fig. 12 - Forward Voltage vs. Ambient Temperature



Fig. 13 - Forward Current vs. Forward Voltage

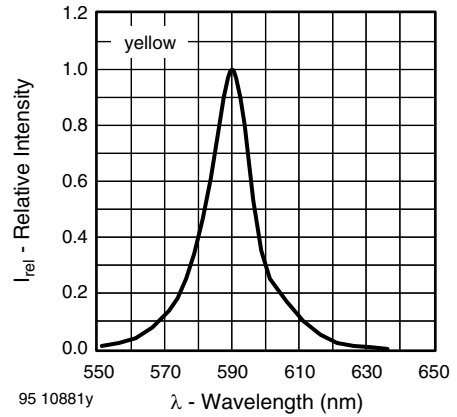

Fig. 16 - Relative Intensity vs. Wavelength

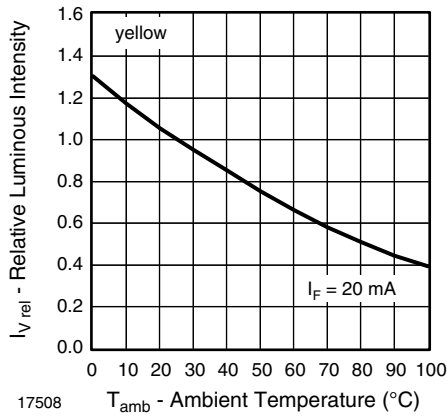

Fig. 14 - Relative Luminous Intensity vs. Ambient Temperature

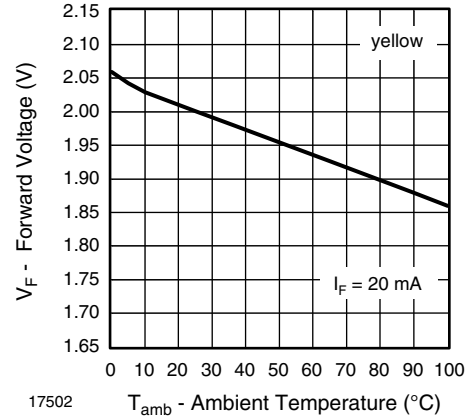

Fig. 17 - Forward Voltage vs. Ambient Temperature

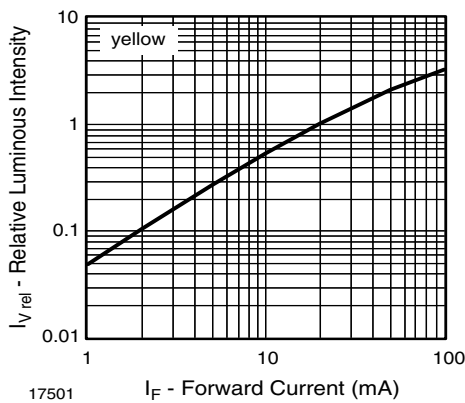
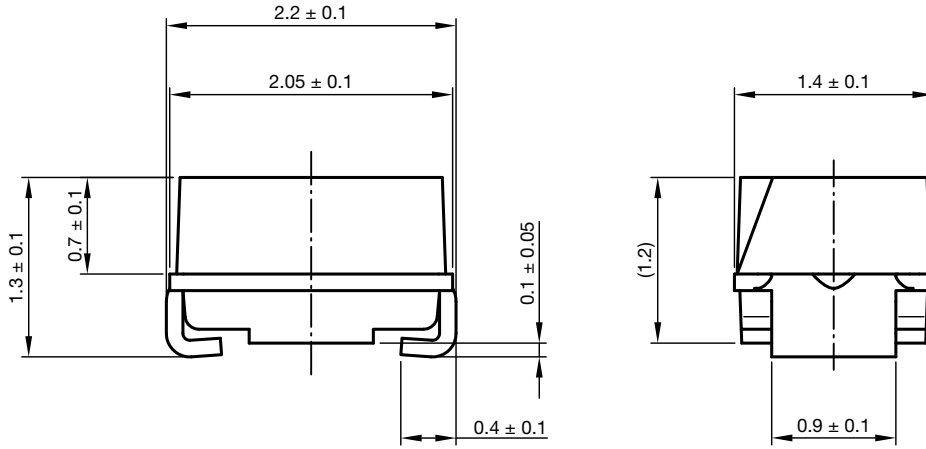

Fig. 15 - Relative Luminous Intensity vs. Forward Current



PACKAGE DIMENSIONS in millimeters



Not indicated tolerances ± 0.2

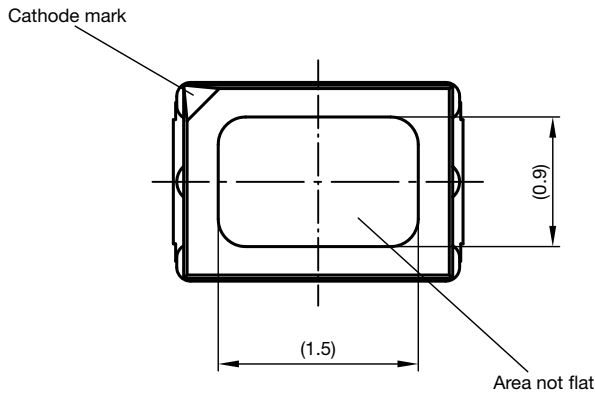

Proposed pad layout (for reference only)

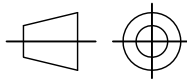
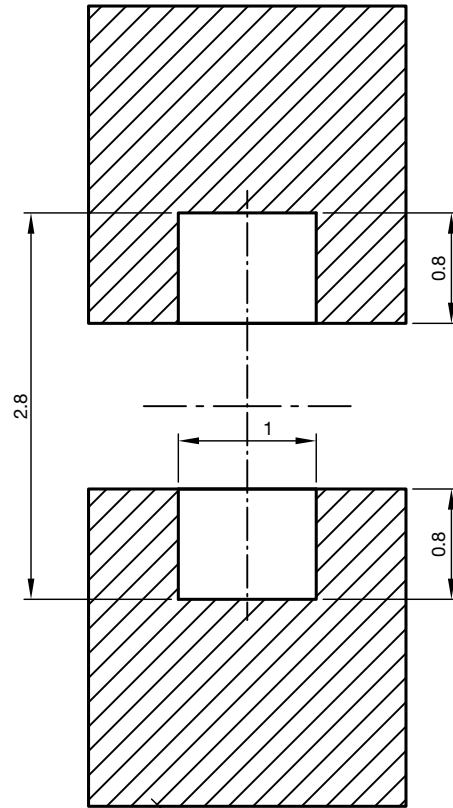

technical drawings according to DIN specifications

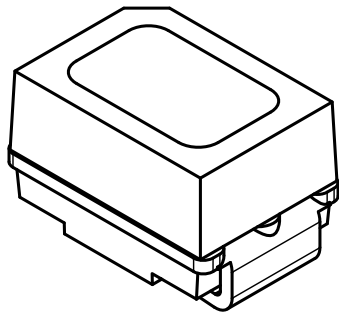

Cu.area > 5 mm²

Drawing-No.: 6.541-5069.01-4
Issue: 2; 24.11.14



REEL DIMENSIONS in millimeters



Drawing-No.: 9.800-5051.V5-4

Issue: 1; 25.07.02

16938



TAPE DIMENSIONS in millimeters

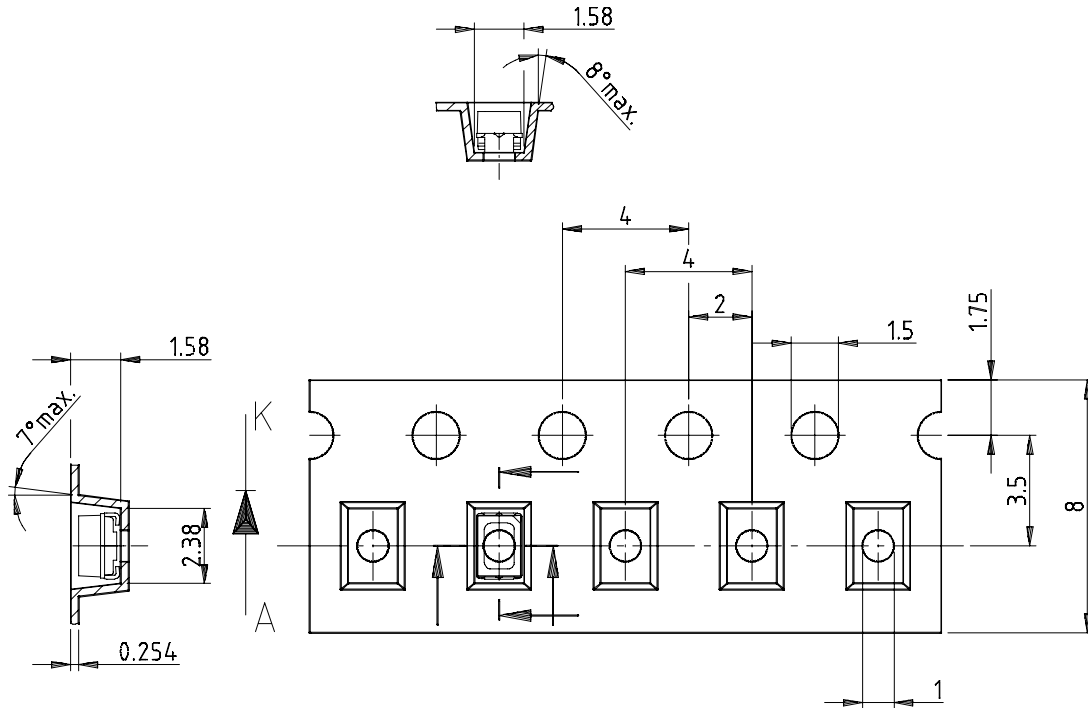

Drawing-No.: 9.700-5266.01-4
 Issue: 1; 05.06.02
 16939

LEADER AND TRAILER DIMENSIONS in millimeters

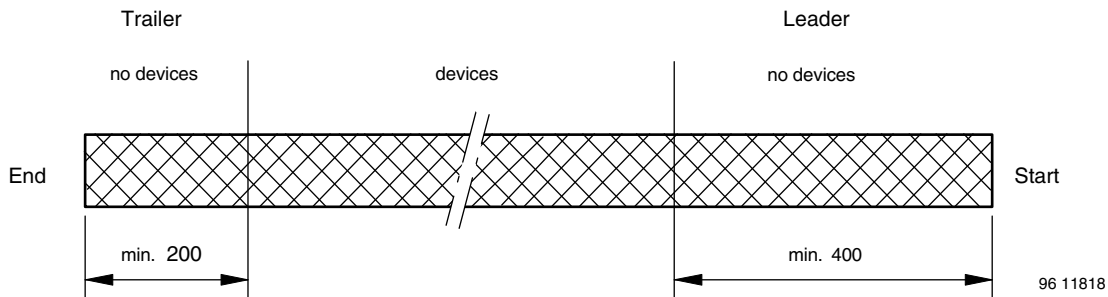

GS08 = 3000 pcs

COVER TAPE PEEL STRENGTH

According to DIN EN 60286-3
 0.1 N to 1.3 N
 300 mm/min ± 10 mm/min
 165° to 180° peel angle

LABEL

Standard bar code labels for finished goods

The standard bar code labels are product labels and used for identification of goods. The finished goods are packed in final packing area. The standard packing units are labeled with standard bar code labels before transported as finished goods to warehouses. The labels are on each packing unit and contain Vishay Semiconductor GmbH specific data.

VISHAY SEMICONDUCTOR GMBH STANDARD BAR CODE PRODUCT LABEL (finished goods)		
PLAIN WRITING	ABBREVIATION	LENGTH
Item-description	-	18
Item-number	INO	8
Selection-code	SEL	3
LOT-/serial-number	BATCH	10
Data-code	COD	3 (YWW)
Plant-code	PTC	2
Quantity	QTY	8
Accepted by:	ACC	-
Packed by:	PCK	-
Mixed code indicator	MIXED CODE	-
Origin	xxxxxxx+	Company logo
LONG BAR CODE TOP	TYPE	LENGTH
Item-number	N	8
Plant-code	N	2
Sequence-number	X	3
Quantity	N	8
Total length	-	21
SHORT BAR CODE BOTTOM	TYPE	LENGTH
Data-code	N	3
Selection-code	X	3
Batch-number	X	10
Filter	-	1
Total length	-	17

SOLDERING PROFILE

Fig. 18 - Vishay Lead (Pb)-free Reflow Soldering Profile (according to J-STD-020)

BAR CODE PRODUCT LABEL (example)

- A. Type of component
- B. Manufacturing plant
- C. SEL - selection code (bin):
e.g.: P2 = code for luminous intensity group
3 = code for color group
- D. Date code year / week
- E. Day code (e.g. 2: Tuesday)
- F. Batch no.
- G. Total quantity
- H. Company code

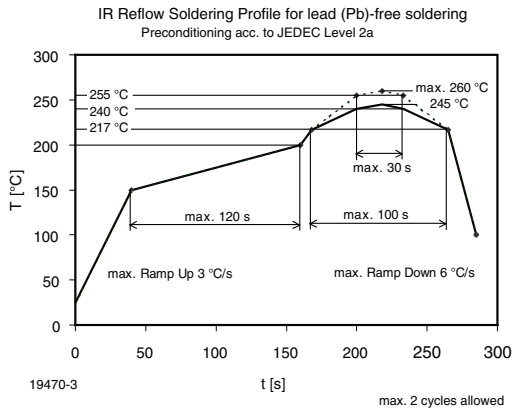

DRY PACKING

The reel is packed in an anti-humidity bag to protect the devices from absorbing moisture during transportation and storage.



15973

FINAL PACKING

The sealed reel is packed into a cardboard box. A secondary cardboard box is used for shipping purposes.

RECOMMENDED METHOD OF STORAGE

Dry box storage is recommended as soon as the aluminum bag has been opened to prevent moisture absorption. The following conditions should be observed, if dry boxes are not available:

- Storage temperature 10 °C to 30 °C
- Storage humidity ≤ 60 % RH max.

After more than 672 h under these conditions moisture content will be too high for reflow soldering.

In case of moisture absorption, the devices will recover to the former condition by drying under the following condition:

- 192 h at 40 °C + 5 °C / - 0 °C and < 5 % RH (dry air / nitrogen) or
- 96 h at 60 °C + 5 °C and < 5 % RH for all device containers or
- 24 h at 100 °C + 5 °C not suitable for reel or tubes.

An EIA JEDEC® standard JESD22-A112 level 2a label is included on all dry bags.

ESD PRECAUTION

Proper storage and handling procedures should be followed to prevent ESD damage to the devices especially when they are removed from the antistatic shielding bag. Electrostatic sensitive devices warning labels are on the packaging.

VISHAY SEMICONDUCTORS STANDARD BAR CODE LABEL

The Vishay Semiconductors standard bar code labels are printed at final packing areas. The labels are on each packing unit and contain Vishay Semiconductors specific data.

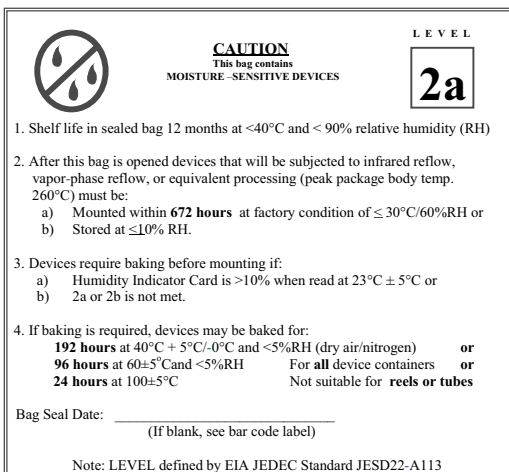

Example of JESD22-A112 level 2a label



Disclaimer

ALL PRODUCT, PRODUCT SPECIFICATIONS AND DATA ARE SUBJECT TO CHANGE WITHOUT NOTICE TO IMPROVE RELIABILITY, FUNCTION OR DESIGN OR OTHERWISE.

Vishay Intertechnology, Inc., its affiliates, agents, and employees, and all persons acting on its or their behalf (collectively, "Vishay"), disclaim any and all liability for any errors, inaccuracies or incompleteness contained in any datasheet or in any other disclosure relating to any product.

Vishay makes no warranty, representation or guarantee regarding the suitability of the products for any particular purpose or the continuing production of any product. To the maximum extent permitted by applicable law, Vishay disclaims (i) any and all liability arising out of the application or use of any product, (ii) any and all liability, including without limitation special, consequential or incidental damages, and (iii) any and all implied warranties, including warranties of fitness for particular purpose, non-infringement and merchantability.

Statements regarding the suitability of products for certain types of applications are based on Vishay's knowledge of typical requirements that are often placed on Vishay products in generic applications. Such statements are not binding statements about the suitability of products for a particular application. It is the customer's responsibility to validate that a particular product with the properties described in the product specification is suitable for use in a particular application. Parameters provided in datasheets and / or specifications may vary in different applications and performance may vary over time. All operating parameters, including typical parameters, must be validated for each customer application by the customer's technical experts. Product specifications do not expand or otherwise modify Vishay's terms and conditions of purchase, including but not limited to the warranty expressed therein.

Except as expressly indicated in writing, Vishay products are not designed for use in medical, life-saving, or life-sustaining applications or for any other application in which the failure of the Vishay product could result in personal injury or death. Customers using or selling Vishay products not expressly indicated for use in such applications do so at their own risk. Please contact authorized Vishay personnel to obtain written terms and conditions regarding products designed for such applications.

No license, express or implied, by estoppel or otherwise, to any intellectual property rights is granted by this document or by any conduct of Vishay. Product names and markings noted herein may be trademarks of their respective owners.