

Wire Wound Chip Inductor (Ferrite)

Features

- Very strong solderability by flow soldering, soldering iron or wave soldering
- Highly accurate dimensions, can be mounted automatically
- Terminals are highly resistant to pull forces
- Highly resistant to mechanical shocks and pressure
- Highly reliable in environments of sudden temperature change and humidity.
- Super Q characteristics



Applications

- Micro Televisions, Liquid Crystal Televisions, Video Cameras, Portable VCRs, Car Radios, Car Stereos, Thin Tape Radios, Television Tuners, Mobile Telephones, Radio and Other Electronic Devices

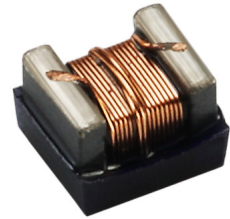

Construction

Molding Type

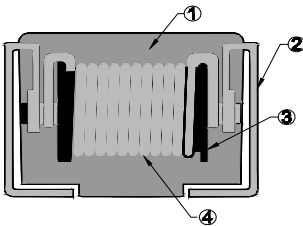

Open Type

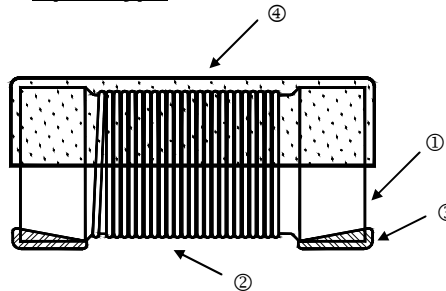

① Molded resin	③ Ferrite core
② Electrode (Tinned Copper Wire)	④ Magnet wire

① Ferrite core	③ Electrode (Ag/Pd+Ni+Sn)
② Magnet wire	④ UV Glue

Part Numbering

NL	05	K	T	C	1R0
Product Type	Dimensions (LxW)	Inductance Tolerance	Packaging Code	Current	Inductance
	03: 0603 05: 0805 08: 1008 10: 1210 12: 1812 20: 2220	J: ±5% K: ±10% M: ±20%	T: Taping Reel	: Standard C: Large Current L: Low Profile	R12: 120nH R27: 270nH 2R7: 2700nH 100: 10µH

Dimensions

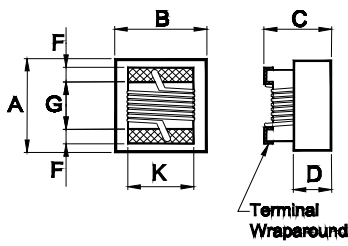

Figure 1

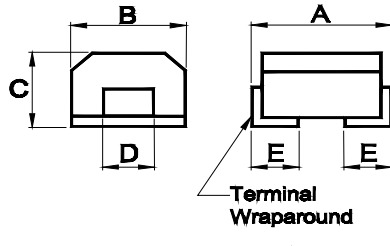

Figure 2

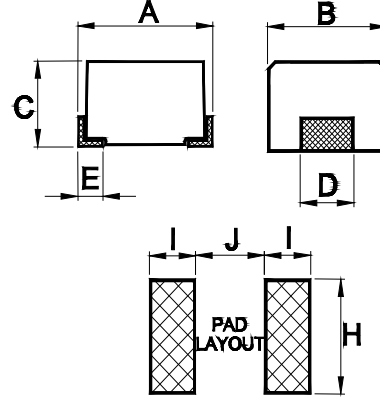

Figure 3

Unit: mm

Type	Size (Inch)	Figure	A	B	C	D	E	F	G	H	I	J	K	Weight (g) (1000pcs)
NL03	0603	1	1.80 max	1.20 max	1.00 max	0.45	-	0.33	0.95	1.02	0.64	0.64	1.05	9.6
NL05	0805	1	2.40 max	1.71 max	1.45 max	0.65	-	0.44	1.02	1.78	1.02	0.76	1.27	14
NL08	1008	1	2.92 max	2.79 max	2.10 max	1.20	-	0.45	1.52	2.54	1.02	1.27	2.03	30
NL10	1210	2	3.2±0.4	2.5±0.2	2.2±0.2	1.0±0.2	0.6-0/+0.3	-	-	1.40	1.00	1.80	-	40
NL12	1812	2	4.5±0.3	3.2±0.2	3.2±0.2	1.20	1.0-0/+0.3	-	-	1.60	1.50	2.20	-	160
NL20	2220	3	5.6±0.3	5.0±0.2	4.0±0.3	4±0.2	0.7±0.2	-	-	4.50	2.00	4.00	-	300
NL05(L)	0805	1	2.29 max	1.73 max	1.00 max	0.51	-	0.44	1.02	1.78	1.02	0.76	1.27	14
NL03(C)	0603	1	1.80 max	1.20 max	1.10 max	0.45	-	0.33	0.95	1.02	0.64	0.64	1.05	9.6
NL05(C)	0805	1	2.40 max	1.71 max	1.45 max	0.65	-	0.44	1.02	1.78	1.02	0.76	1.27	14
NL08(C)	1008	1	2.92 max	2.79 max	2.10 max	1.30	-	0.45	1.52	2.54	1.02	1.27	2.03	30
NL10(C)	1210	2	3.2±0.4	2.5±0.2	2.2±0.2	1.0±0.2	0.6-0/+0.3	-	-	1.40	1.00	1.80	-	40
NL12(C)	1812	2	4.5±0.3	3.2±0.2	3.2±0.2	1.20	1.0-0/+0.3	-	-	1.60	1.50	2.20	-	160
NL20(C)	2220	3	5.6±0.3	5.0±0.2	4.0±0.3	4±0.2	0.7±0.2	-	-	4.50	2.00	4.00	-	300

Color Coding

0603 / 0805 / 1008 Type (except NL05(L))

Because of small sizes, these parts are marked with a single color dot.

The inductance value represented by the dot is shown on the data page for each type.

0603/0805

1st Code

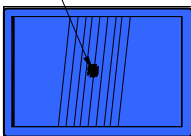

Color Coding

1008

1st Code 3rd Code



2nd Code

Color Coding

■ Standard Electrical Specifications



NL03 Wire Wound Chip Inductors (Ferrite / Open Type) / Standard Type

Codes	Inductance (μH)	Tolerance	Q typ.	Test Freq. (MHz)	SRF (MHz) typ.	DCR (Ω) max.	IDC (mA) max.	Color Code
1R0	1.0	±10, ±20%	16	7.96	390	0.416	860	Black
1R5	1.5	±10, ±20%	16	7.96	160	0.520	720	Brown
1R8	1.8	±10, ±20%	16	7.96	121	0.559	640	Red
2R2	2.2	±10, ±20%	16	7.96	103	0.728	600	Orange
2R7	2.7	±10, ±20%	16	7.96	72	0.806	540	Yellow
3R3	3.3	±10, ±20%	16	7.96	66	0.910	500	Green
3R9	3.9	±10, ±20%	16	7.96	61	1.079	460	Blue
4R7	4.7	±10, ±20%	16	7.96	51	1.261	400	Violet
5R6	5.6	±10, ±20%	16	7.96	47	1.430	380	Gray
6R8	6.8	±10, ±20%	16	7.96	43	1.950	340	White
8R2	8.2	±10, ±20%	16	7.96	40	2.184	300	Black
100	10	±10, ±20%	14	2.52	36	2.405	280	Brown
120	12	±10, ±20%	14	2.52	32	2.964	260	Red
150	15	±10, ±20%	14	2.52	29	3.380	240	Orange
180	18	±10, ±20%	14	2.52	28	3.770	220	Yellow
220	22	±10, ±20%	14	2.52	24	4.693	200	Green
270	27	±10, ±20%	14	2.52	20	6.760	140	Blue
330	33	±10, ±20%	14	2.52	15	8.580	120	Violet



NL05 Wire Wound Chip Inductors (Ferrite / Open Type) / Standard Type

Codes	Inductance (μH)	Tolerance	Q min.	Test Freq. (MHz)	SRF (MHz) min.	DCR (Ω) max.	IDC (mA) max.	Color Code
R11	0.11	±10%	25	25.2	1200	0.05	2000	White
R12	0.12	±5, ±10%	20	25.2	700	0.18	1100	Violet
R15	0.15	±5, ±10%	20	25.2	900	0.18	1100	Gray
R18	0.18	±5, ±10%	20	25.2	600	0.20	800	Black
R22	0.22	±5, ±10%	20	25.2	550	0.25	700	Brown
R27	0.27	±5, ±10%	20	25.2	550	0.38	700	Red
R33	0.33	±5, ±10%	20	25.2	550	0.35	650	Orange
R39	0.39	±5, ±10%	20	25.2	420	0.35	600	Yellow
R47	0.47	±5, ±10%	20	25.2	350	0.45	600	Green
R56	0.56	±5, ±10%	20	25.2	300	0.45	550	Blue
R62	0.62	±5, ±10%	30	25.2	640	0.45	980	Brown
R68	0.68	±5, ±10%	20	25.2	300	0.60	500	Violet
R82	0.82	±5, ±10%	20	25.2	300	0.55	500	Gray
R91	0.91	±5, ±10%	30	25.2	500	0.55	900	Yellow
1R0	1.0	±5, ±10%	15	7.96	280	0.80	450	White
1R2	1.2	±5, ±10%	15	7.96	280	0.90	400	Black
1R5	1.5	±5, ±10%	15	7.96	250	1.05	350	Brown
1R8	1.8	±5, ±10%	15	7.96	120	1.00	350	Red
2R2	2.2	±5, ±10%	15	7.96	110	1.10	320	Orange
2R7	2.7	±5, ±10%	15	7.96	70	1.20	320	Yellow
3R3	3.3	±5, ±10%	15	7.96	60	1.50	300	Green
3R9	3.9	±5, ±10%	15	7.96	55	1.75	300	Blue
4R7	4.7	±5, ±10%	15	7.96	45	2.10	200	Violet
5R6	5.6	±5, ±10%	15	7.96	40	2.30	250	Gray
6R8	6.8	±5, ±10%	15	7.96	36	2.70	200	White
8R2	8.2	±5, ±10%	15	7.96	33	3.30	180	Black
100	10	±5, ±10%	10	2.52	30	4.50	180	Brown
120	12	±5, ±10%	16	2.52	37	2.80	220	Red
150	15	±5, ±10%	16	2.52	30	3.80	200	Orange
180	18	±5, ±10%	16	2.52	23	4.48	180	Yellow
220	22	±5, ±10%	16	2.52	20	6.30	160	Green
270	27	±5, ±10%	16	2.52	19	6.85	140	Blue
330	33	±5, ±10%	16	2.52	18	7.60	120	Violet
390	39	±5, ±10%	15	2.52	16	8.20	100	Gray

NL03, NL05, NL08, NL10, NL12, NL20

Wire Wound Chip Inductor (Ferrite)



NL08 Wire Wound Chip Inductors (Ferrite / Open Type) / Standard Type

Codes	Inductance (μH)	Tolerance	Q min.	Test Freq. (MHz)	SRF (MHz) min.	DCR (Ω) max.	IDC (mA) max.	Color Code		
R12	0.12	±5, ±10%	26	25.2	800	0.30	1000	Brown	Red	Brown
R18	0.18	±5, ±10%	30	25.2	600	0.30	960	Brown	Gray	Brown
R20	0.20	±5, ±10%	30	25.2	735	0.30	960	Red	Black	Brown
R22	0.22	±5, ±10%	27	25.2	600	0.40	880	Red	Red	Brown
R27	0.27	±5, ±10%	29	25.2	425	0.42	900	Red	Violet	Brown
R33	0.33	±5, ±10%	30	25.2	400	0.42	900	Orange	Orange	Brown
R39	0.39	±5, ±10%	30	25.2	375	0.45	700	Orange	White	Brown
R47	0.47	±5, ±10%	30	25.2	350	0.50	900	Yellow	Violet	Brown
R56	0.56	±5, ±10%	30	25.2	325	0.55	850	Green	Blue	Brown
R62	0.62	±5, ±10%	30	25.2	460	0.55	900	Blue	Red	Brown
R68	0.68	±5, ±10%	30	25.2	300	0.55	800	Blue	Gray	Brown
R75	0.75	±5, ±10%	30	25.2	420	0.65	880	Violet	Green	Brown
R82	0.82	±5, ±10%	30	25.2	260	0.65	700	Gray	Red	Brown
R91	0.91	±5, ±10%	30	25.2	400	0.65	840	White	Brown	Brown
1R0	1.0	±5, ±10%	25	7.96	245	0.60	600	Brown	Black	Red
1R2	1.2	±5, ±10%	25	7.96	230	0.74	600	Brown	Red	Red
1R5	1.5	±5, ±10%	25	7.96	182	0.85	550	Brown	Green	Red
1R8	1.8	±5, ±10%	25	7.96	135	0.92	500	Brown	Gray	Red
2R2	2.2	±5, ±10%	25	7.96	105	1.10	500	Red	Red	Red
2R7	2.7	±5, ±10%	25	7.96	70	1.22	350	Red	Violet	Red
3R3	3.3	±5, ±10%	25	7.96	55	1.37	350	Orange	Orange	Red
3R9	3.9	±5, ±10%	25	7.96	48	1.66	310	Orange	White	Red
4R7	4.7	±5, ±10%	25	7.96	43	1.68	300	Yellow	Violet	Red
5R6	5.6	±5, ±10%	25	7.96	42	1.75	300	Green	Blue	Red
6R8	6.8	±5, ±10%	25	7.96	39	1.85	300	Blue	Gray	Red
8R2	8.2	±5, ±10%	25	7.96	36	2.00	250	Gray	Red	Red
100	10	±5, ±10%	20	2.52	33	2.32	250	Brown	Black	Orange
120	12	±5, ±10%	15	2.52	28	2.99	200	Brown	Red	Orange
150	15	±5, ±10%	15	2.52	24	3.42	200	Brown	Green	Orange
180	18	±5, ±10%	15	2.52	20	4.65	180	Brown	Gray	Orange
220	22	±5, ±10%	15	2.52	18	5.12	180	Red	Red	Orange
270	27	±5, ±10%	15	2.52	17	5.76	160	Red	Violet	Orange
330	33	±5, ±10%	15	2.52	16	6.44	120	Orange	Orange	Orange
390	39	±5, ±10%	15	2.52	15	6.85	120	Orange	White	Orange
470	47	±5, ±10%	14	2.52	13	9.94	110	Yellow	Violet	Orange
560	56	±5, ±10%	14	2.52	10	10.7	90	Green	Blue	Orange
680	68	±5, ±10%	14	2.52	8	12.8	90	Blue	Gray	Orange
820	82	±5, ±10%	14	2.52	8	18.3	80	Gray	Red	Orange
101	100	±5, ±10%	8	1	7	19.6	120	Brown	Black	Yellow



NL10 Wire Wound Chip Inductors (Ferrite / Molding Type) / Standard Type

Codes	Inductance (μH)	Tolerance	Q min.	Test Freq. (MHz)	SRF (MHz) min.	DCR (Ω) max.	IDC (mA) max.
R18	0.18	±20%	30	25.2	400	0.28	450
R22	0.22	±20%	30	25.2	350	0.32	450
R27	0.27	±20%	30	25.2	320	0.36	450
R33	0.33	±20%	30	25.2	300	0.40	450
R39	0.39	±20%	30	25.2	250	0.45	450
R47	0.47	±20%	30	25.2	220	0.50	450
R56	0.56	±20%	30	25.2	180	0.55	450
R68	0.68	±20%	30	25.2	160	0.60	450
R82	0.82	±20%	30	25.2	140	0.65	450
1R0	1.0	±10%	30	7.96	120	0.70	400
1R2	1.2	±10%	30	7.96	100	0.75	390
1R5	1.5	±10%	30	7.96	85	0.85	370
1R8	1.8	±10%	30	7.96	80	0.90	350
2R2	2.2	±10%	30	7.96	75	1.00	320
2R7	2.7	±10%	30	7.96	70	1.10	290
3R3	3.3	±10%	30	7.96	60	1.20	260
3R9	3.9	±10%	30	7.96	55	1.30	250
4R7	4.7	±10%	30	7.96	50	1.50	220
5R6	5.6	±10%	30	7.96	45	1.60	200
6R8	6.8	±10%	30	7.96	40	1.80	180
8R2	8.2	±10%	30	7.96	35	2.00	170
100	10	±10%	30	2.52	30	2.10	150
120	12	±10%	30	2.52	20	2.50	140
150	15	±10%	30	2.52	20	2.80	130
180	18	±10%	30	2.52	20	3.30	120
220	22	±10%	30	2.52	20	3.70	110
270	27	±10%	30	2.52	20	5.00	80
330	33	±10%	30	2.52	17	5.60	70
390	39	±10%	30	2.52	16	6.40	65
470	47	±10%	30	2.52	15	7.00	60
560	56	±10%	30	2.52	13	8.00	55
680	68	±10%	30	2.52	12	9.00	50
820	82	±10%	30	2.52	11	10.00	45
101	100	±10%	20	0.796	10	10.00	40
121	120	±10%	20	0.796	10	11.00	70
151	150	±10%	20	0.796	8	15.00	65



Codes	Inductance (µH)	Tolerance	Q min.	Test Freq. (MHz)	SRF (MHz) min.	DCR (Ω) max.	IDC (mA) max.
R18	0.18	±20%	30	25.2	220	0.24	700
R22	0.22	±20%	30	25.2	200	0.25	665
R27	0.27	±20%	30	25.2	180	0.26	635
R33	0.33	±20%	30	25.2	165	0.28	605
R39	0.39	±20%	30	25.2	150	0.30	575
R47	0.47	±20%	30	25.2	145	0.32	545
R56	0.56	±20%	30	25.2	140	0.36	520
R68	0.68	±20%	30	25.2	135	0.40	500
R82	0.82	±20%	30	25.2	130	0.45	475
1R0	1.0	±10%	50	7.96	100	0.50	450
1R2	1.2	±10%	50	7.96	80	0.55	430
1R5	1.5	±10%	50	7.96	70	0.60	410
1R8	1.8	±10%	50	7.96	60	0.65	390
2R2	2.2	±10%	50	7.96	55	0.70	380
2R7	2.7	±10%	50	7.96	50	0.75	370
3R3	3.3	±10%	50	7.96	45	0.80	355
3R9	3.9	±10%	50	7.96	40	0.90	330
4R7	4.7	±10%	50	7.96	35	1.00	315
5R6	5.6	±10%	50	7.96	33	1.10	300
6R8	6.8	±10%	50	7.96	27	1.20	285
8R2	8.2	±10%	50	7.96	25	1.40	270
100	10	±10%	50	2.52	20	1.60	250
120	12	±10%	50	2.52	18	2.00	225
150	15	±10%	50	2.52	17	2.50	200
180	18	±10%	50	2.52	15	2.80	190
220	22	±10%	50	2.52	13	3.20	180
270	27	±10%	50	2.52	12	3.60	170
330	33	±10%	50	2.52	11	4.00	160
390	39	±10%	50	2.52	10	4.50	150
470	47	±10%	50	2.52	10	5.00	140
560	56	±10%	50	2.52	9	5.50	135
680	68	±10%	50	2.52	9	6.00	130
820	82	±10%	50	2.52	8	7.00	120
101	100	±10%	40	0.796	8	8.00	110
121	120	±10%	40	0.796	6	8.00	110
151	150	±10%	40	0.796	5	9.00	105
181	180	±10%	40	0.796	5	9.50	102
221	220	±10%	40	0.796	4	10.0	100
271	270	±10%	30	0.796	4	15.0	92
331	330	±10%	30	0.796	3.5	15.0	85
391	390	±10%	30	0.796	3	18.0	80
471	470	±10%	30	0.796	3	26.0	62
561	560	±10%	30	0.796	3	30.0	50
681	680	±10%	30	0.796	3	30.0	50
821	820	±10%	30	0.796	2.5	43.0	30



NL20 Wire Wound Chip Inductors (Ferrite / Molding Type) / Standard Type

Codes	Inductance (mH)	Tolerance	Test Freq. (MHz)	Q min.	SRF (MHz) min.	DCR (Ω) max.	IDC (mA) max.
122	1.2	±5, ±10%	0.252	20	1.5	17	75
152	1.5	±5, ±10%	0.252	20	1.4	20	70
182	1.8	±5, ±10%	0.252	20	1.3	30	60
222	2.2	±5, ±10%	0.252	20	1.2	35	55
272	2.7	±5, ±10%	0.252	20	1.1	55	45
332	3.3	±5, ±10%	0.252	20	1.0	60	40
392	3.9	±5, ±10%	0.252	20	1.0	70	38
472	4.7	±5, ±10%	0.252	20	0.9	78	36
562	5.6	±5, ±10%	0.252	20	0.8	85	33
682	6.8	±5, ±10%	0.252	20	0.7	110	30
822	8.2	±5, ±10%	0.252	20	0.6	125	28
103	10	±5, ±10%	0.0796	15	0.5	150	25

Low Profile Electrical Specifications



NL05 Wound Chip Inductors (Ferrite / Open Type) / **Low Profile Type**

Codes	Inductance (μH)	Tolerance	Q min.	Test Freq. (MHz)	SRF (MHz) min.	DCR (Ω) max.	IDC (mA) max.
1R0	1.0	±5, ±10%	15	L: 7.96 / Q: 25.2	115	0.90	450
3R3	3.3	±5, ±10%	13	7.96	70	1.40	450
4R7	4.7	±5, ±10%	15	7.96	65	1.90	400
6R8	6.8	±5, ±10%	15	7.96	41	2.40	400
100	10	±5, ±10%	14	7.96	31	2.70	400
150	15	±5, ±10%	12	7.96	28	5.00	300
220	22	±5, ±10%	10	7.96	25	6.00	250

Large Current Electrical Specifications



NL03 Wound Chip Inductors (Ferrite / Open Type) / Large Current Type

Codes	Inductance (μH)	Tolerance	Q min.	Test Freq. (MHz)	SRF (MHz) min.	DCR (Ω) max.	IDC (mA) max.	Color Code
47N	0.047	±10%	12	7.96	2000	0.075	1800	White
51N	0.051	±10%	12	7.96	1500	0.075	1800	Violet
68N	0.068	±10%	12	7.96	1500	0.12	1800	Gray
72N	0.072	±10%	12	7.96	1500	0.12	1800	Brown
R10	0.10	±10%	12	7.96	1150	0.13	1700	Black
R12	0.12	±5, ±10%	12	7.96	1100	0.15	1700	Orange
R15	0.15	±5, ±10%	15	7.96	1050	0.15	1600	Brown
R18	0.18	±5, ±10%	15	7.96	950	0.15	1500	Green
R22	0.22	±5, ±10%	15	7.96	900	0.30	1200	Red
R24	0.24	±5, ±10%	15	7.96	850	0.16	1460	Green
R27	0.27	±5, ±10%	15	7.96	835	0.30	1460	Yellow
R33	0.33	±5, ±10%	15	7.96	725	0.40	1420	Orange
R39	0.39	±5, ±10%	15	7.96	680	0.41	1400	Blue
R47	0.47	±5, ±10%	15	7.96	640	0.43	1400	Black
R56	0.56	±5, ±10%	15	7.96	630	0.44	1400	Brown
R68	0.68	±5, ±10%	15	7.96	510	0.52	1340	Red
R78	0.78	±5, ±10%	15	7.96	465	0.63	1300	Orange
R82	0.82	±5, ±10%	15	7.96	460	0.69	1200	Yellow
1R0	1.0	±5, ±10%	15	7.96	320	0.81	1100	Green
1R2	1.2	±5, ±10%	15	7.96	270	0.87	1000	Blue
1R5	1.5	±5, ±10%	15	7.96	230	0.96	920	Violet
1R8	1.8	±5, ±10%	15	7.96	210	1.10	900	Gray
2R2	2.2	±5, ±10%	15	7.96	115	1.20	740	White
2R7	2.7	±5, ±10%	15	7.96	100	1.38	700	Black
3R3	3.3	±5, ±10%	15	7.96	84	1.50	680	Brown
3R9	3.9	±5, ±10%	15	7.96	75	1.50	600	Red
4R7	4.7	±5, ±10%	15	7.96	67	2.10	580	Orange
5R6	5.6	±5, ±10%	15	7.96	55	2.37	540	Yellow
6R8	6.8	±5, ±10%	15	7.96	48	3.10	500	Green
7R8	7.8	±5, ±10%	15	7.96	40	3.35	460	Blue
8R2	8.2	±5, ±10%	15	7.96	38	3.50	440	Violet
100	10	±5, ±10%	15	7.96	32	4.46	400	Gray

NL03, NL05, NL08, NL10, NL12, NL20

Wire Wound Chip Inductor (Ferrite)



NL05 Wire Wound Chip Inductors (Ferrite / Open Type) / **Large Current Type**

Codes	Inductance (μH)	Tolerance	Q typ.	Test Freq. (MHz)	SRF (MHz) typ.	DCR (Ω) max.	IDC (mA) max.	Color Code
R47	0.47	±10, ±20%	14	25.2	850	0.156	1400	Blue
R68	0.68	±10, ±20%	14	25.2	765	0.195	1200	Gray
1R0	1.00	±10, ±20%	14	7.96	208	0.169	1100	Black
1R2	1.20	±10, ±20%	14	7.96	159	0.208	960	Red
1R5	1.50	±10, ±20%	14	7.96	159	0.221	920	Brown
1R8	1.80	±10, ±20%	14	7.96	112	0.260	860	Orange
2R2	2.20	±10, ±20%	13	7.96	87	0.286	740	Red
2R7	2.70	±10, ±20%	13	7.96	72	0.325	680	Yellow
3R3	3.30	±10, ±20%	12	7.96	70	0.364	620	Orange
3R9	3.90	±10, ±20%	14	7.96	61	0.494	580	Green
4R7	4.70	±10, ±20%	14	7.96	51	0.559	520	Yellow
5R6	5.60	±10, ±20%	12	7.96	47	0.650	480	Blue
6R8	6.80	±10, ±20%	14	7.96	46	0.884	420	Green
8R2	8.20	±10, ±20%	13	7.96	33	0.949	400	Violet
100	10	±5, ±10, ±20%	14	2.52	31	1.105	360	Blue
120	12	±5, ±10, ±20%	14	2.52	30	1.17	340	Gray
150	15	±5, ±10, ±20%	15	2.52	28	1.82	300	Violet
180	18	±5, ±10, ±20%	15	2.52	27	2.01	280	White
220	22	±5, ±10, ±20%	15	2.52	20	2.28	240	Gray
270	27	±5, ±10, ±20%	15	2.52	17	2.60	220	Black
330	33	±5, ±10, ±20%	15	2.52	17	3.05	200	White
470	47	±5, ±10, ±20%	14	2.52	15	4.42	160	Black
560	56	±5, ±10, ±20%	14	2.52	10	5.74	150	Yellow
680	68	±5, ±10, ±20%	14	2.52	10	5.78	140	Brown
820	82	±5, ±10, ±20%	14	2.52	10	9.75	100	Orange
101	100	±5, ±10, ±20%	10	1	9	9.75	100	Red



NL08 Wound Chip Inductors (Ferrite / Open Type) / Large Current Type

Codes	Inductance (μH)	Tolerance	Q typ.	Test Freq. (MHz)	SRF (MHz) min.	DCR (Ω) max.	IDC (mA) max.	Color Code		
								1st	2nd	3rd
R10	0.10	±5, ±10%	35	25.2	1500	0.05	3200	Brown	Red	Brown
R22	0.22	±5, ±10%	35	25.2	800	0.15	2600	Red	Red	Brown
R39	0.39	±5, ±10%	35	25.2	460	0.20	2100	Orange	White	Brown
R47	0.47	±10%	35	25.2	460	0.20	2400	Yellow	Violet	Brown
R56	0.56	±5, ±10%	35	25.2	360	0.26	1800	Green	Blue	Brown
R68	0.68	±5, ±10%	35	25.2	400	0.30	1700	Blue	Gray	Brown
R82	0.82	±5, ±10%	35	25.2	360	0.35	1400	Gray	Red	Brown
1R0	1.0	±10%	22	7.96	245	0.35	800	Brown	Black	Red
1R2	1.2	±5, ±10%	25	7.96	230	0.40	550	Brown	Red	Red
1R5	1.5	±5, ±10%	25	7.96	182	0.45	550	Brown	Green	Red
1R8	1.8	±5, ±10%	25	7.96	135	0.55	550	Brown	Gray	Red
2R2	2.2	±5, ±10%	22	7.96	105	0.60	500	Red	Red	Red
2R7	2.7	±5, ±10%	25	7.96	70	0.70	500	Red	Violet	Red
3R3	3.3	±5, ±10%	22	7.96	55	0.75	450	Orange	Orange	Red
3R9	3.9	±5, ±10%	25	7.96	50	0.80	450	Orange	White	Red
4R7	4.7	±5, ±10%	22	7.96	45	0.90	400	Yellow	Violet	Red
5R6	5.6	±5, ±10%	22	7.96	42	1.05	400	Green	Blue	Red
6R8	6.8	±5, ±10%	22	7.96	40	1.05	400	Blue	Gray	Red
8R2	8.2	±5, ±10%	22	7.96	36	1.30	350	Gray	Red	Red
100	10	±5, ±10%	20	2.52	35	1.55	300	Brown	Black	Orange
120	12	±5, ±10%	20	2.52	30	2.10	280	Brown	Red	Orange
150	15	±5, ±10%	20	2.52	24	2.38	250	Brown	Green	Orange
180	18	±5, ±10%	20	2.52	20	2.60	200	Brown	Gray	Orange
220	22	±5, ±10%	20	2.52	18	2.92	200	Red	Red	Orange
330	33	±5, ±10%	20	2.52	16	4.10	180	Orange	Orange	Orange
470	47	±5, ±10%	23	2.52	17	7.80	350	Yellow	Violet	Orange
101	100	±5, ±10%	13	1	4	13.2	200	Brown	Black	Yellow
221	220	±5, ±10%	13	1	3	26.5	140	Red	Red	Yellow
331	330	±5, ±10%	13	1	2	32.5	110	Orange	Orange	Yellow

NL10 Wire Wound Chip Inductors (Ferrite / Molding Type) / Large Current Type



Codes	Inductance (μH)	Tolerance	Q min.	Test Freq. (MHz)	SRF (MHz) min.	DCR (Ω) max.	IDC (mA) max.
1R0	1.0	±20%	10	7.96	100	0.156	770
1R5	1.5	±20%	10	7.96	80	0.195	580
2R2	2.2	±20%	10	7.96	65	0.260	480
3R3	3.3	±20%	10	7.96	55	0.325	400
4R7	4.7	±20%	10	7.96	45	0.520	320
6R8	6.8	±20%	10	7.96	35	0.650	280
100	10	±10%	15	2.52	28	1.105	220
150	15	±10%	15	2.52	25	1.690	180
220	22	±10%	15	2.52	20	2.600	145
270	27	±10%	15	2.52	17	3.000	125
330	33	±10%	15	2.52	15	3.640	115
470	47	±10%	20	2.52	13	5.460	105
680	68	±10%	20	2.52	10	8.450	85
820	82	±10%	20	2.52	9	8.710	80
101	100	±10%	20	0.796	8	10.140	75



NL12 Wire Wound Chip Inductors (Ferrite / Molding Type) / Large Current Type

Codes	Inductance (μH)	Tolerance	Q min.	Test Freq. (MHz)	SRF (MHz) min.	DCR (Ω) max.	IDC (mA) max.
1R0	1.0	±10%	10	7.96	200	0.11	1050
1R2	1.2	±10%	10	7.96	160	0.12	1000
1R5	1.5	±10%	10	7.96	130	0.15	950
1R8	1.8	±10%	10	7.96	100	0.16	900
2R2	2.2	±10%	10	7.96	80	0.18	850
2R7	2.7	±10%	10	7.96	60	0.20	800
3R3	3.3	±10%	10	7.96	45	0.22	750
3R9	3.9	±10%	10	7.96	40	0.24	700
4R7	4.7	±10%	10	7.96	35	0.27	650
5R6	5.6	±10%	10	7.96	30	0.30	650
6R8	6.8	±10%	10	7.96	28	0.35	600
8R2	8.2	±10%	10	7.96	25	0.40	600
100	10	±10%	10	2.52	22	0.50	550
120	12	±10%	10	2.52	21	0.60	500
150	15	±10%	10	2.52	20	0.70	450
180	18	±10%	10	2.52	19	0.80	400
220	22	±10%	10	2.52	18	0.90	370
270	27	±10%	10	2.52	16	1.20	330
330	33	±10%	10	2.52	14	1.40	300
390	39	±10%	10	2.52	12	1.60	280
470	47	±10%	10	2.52	11.5	1.90	260
560	56	±10%	10	2.52	11	2.20	240
680	68	±10%	10	2.52	10	2.60	220
820	82	±10%	10	2.52	9	3.50	200
101	100	±10%	20	0.796	8	4.00	180
121	120	±10%	20	0.796	7.5	4.50	160
151	150	±10%	20	0.796	7	6.50	140
181	180	±10%	20	0.796	6.5	7.50	120
221	220	±10%	20	0.796	5.5	9.00	120
271	270	±10%	20	0.796	5	11.0	100
331	330	±10%	20	0.796	4	13.0	90
391	390	±10%	20	0.796	3.8	23.0	80
471	470	±10%	20	0.796	3.5	26	75
561	560	±10%	20	0.796	2.8	30	70
681	680	±10%	20	0.796	2.6	40	65
821	820	±10%	20	0.796	2.5	45	60



NL20 Wire Wound Chip Inductors (Ferrite / Molding Type) / Large Current Type

Codes	Inductance (μH)	Tolerance	Q min.	Test Freq. (MHz)	SRF (MHz) min.	DCR (Ω) max.	IDC (mA) max.
1R0	1.0	±10, ±20%	10	7.96	95	0.03	1800
1R2	1.2	±10, ±20%	10	7.96	70	0.035	1700
1R5	1.5	±10, ±20%	10	7.96	55	0.04	1600
1R8	1.8	±10, ±20%	10	7.96	47	0.05	1400
2R2	2.2	±10, ±20%	10	7.96	42	0.06	1300
2R7	2.7	±10, ±20%	10	7.96	37	0.07	1200
3R3	3.3	±10, ±20%	10	7.96	34	0.08	1120
3R9	3.9	±10, ±20%	10	7.96	32	0.09	1050
4R7	4.7	±10, ±20%	10	7.96	29	0.11	950
5R6	5.6	±10, ±20%	10	7.96	26	0.13	880
6R8	6.8	±10, ±20%	10	7.96	24	0.15	810
8R2	8.2	±10, ±20%	10	7.96	22	0.18	750
100	10	±10, ±20%	10	2.52	19	0.21	690
120	12	±10, ±20%	10	2.52	17	0.25	630
150	15	±10, ±20%	10	2.52	16	0.30	580
180	18	±10, ±20%	10	2.52	14	0.36	530
220	22	±5, ±10%	10	2.52	13	0.43	480
270	27	±5, ±10%	10	2.52	11.5	0.52	440
330	33	±5, ±10%	10	2.52	10.5	0.62	400
390	39	±5, ±10%	10	2.52	9.5	0.72	370
470	47	±5, ±10%	10	2.52	8.5	0.85	340
560	56	±5, ±10%	10	2.52	7.8	1.00	310
680	68	±5, ±10%	10	2.52	7.0	1.2	290
820	82	±5, ±10%	10	2.52	6.4	1.4	270
101	100	±5, ±10%	20	0.796	6.0	1.6	250
121	120	±5, ±10%	20	0.796	5.4	1.9	230
151	150	±5, ±10%	20	0.796	4.8	2.2	210
181	180	±5, ±10%	20	0.796	4.4	2.8	190
221	220	±5, ±10%	20	0.796	3.9	3.4	170
271	270	±5, ±10%	20	0.796	3.6	4.2	155
331	330	±5, ±10%	20	0.796	3.2	4.9	140
391	390	±5, ±10%	20	0.796	2.9	5.8	130
471	470	±5, ±10%	20	0.796	2.6	7.0	120
561	560	±5, ±10%	20	0.796	2.4	8.5	110
681	680	±5, ±10%	20	0.796	2.2	10	100
821	820	±5, ±10%	20	0.796	2.0	13	90
102	1000	±5, ±10%	20	0.252	1.8	15	85

Environmental Characteristics

Electrical Performance Test

Item	Requirement	Test Method
Inductance	Refer to standard electrical characteristic spec.	HP4291 or HP4284
Q		HP4291 or HP4284
SRF		HP4291
DC Resistance DCR		Agilent 34401A
Rated Current IDC		Applied the current to coils, The inductance change should be less than 10% to initial value

Mechanical Performance Test

Item	Requirement	Test Method
Solderability	The electrodes shall be at least 90% covered with new solder coating	Lead-free inductor: after fluxing(alpha 100 or equiv), inductor shall be dipped in a melted solder bath at 245±5°C, 5±0.5 seconds
Resistance to Soldering Heat	Appearance: No damage	Pre-heating: 150°C, 1min. Solder Temperature: 260±5°C Immersion Time: 10±1 seconds
Vibration	Appearance: No damage L change: within±10% Q change: within±30% DCR: within specification	Test device shall be soldered on the substrate Oscillation Frequency: 10 to 55 to 10Hz for 1 min. Amplitude: 1.5 mm Time: 2 hrs for each axis (X, Y&Z), total 6 hrs

Climatic Test

Item	Requirement	Test Method															
Temperature Cycle	Appearance: No damage L change: within±10% Q change: within±30% DCR: within specification	One cycle: <table border="1"> <thead> <tr> <th>Step</th> <th>Temperature (°C)</th> <th>Time (min.)</th> </tr> </thead> <tbody> <tr> <td>1</td> <td>-25±3</td> <td>30</td> </tr> <tr> <td>2</td> <td>25±2</td> <td>3</td> </tr> <tr> <td>3</td> <td>85±3</td> <td>30</td> </tr> <tr> <td>4</td> <td>25±2</td> <td>3</td> </tr> </tbody> </table>	Step	Temperature (°C)	Time (min.)	1	-25±3	30	2	25±2	3	3	85±3	30	4	25±2	3
Step		Temperature (°C)	Time (min.)														
1		-25±3	30														
2		25±2	3														
3		85±3	30														
4	25±2	3															
Damp Heat with Load	Total: 100 cycles Measured after exposure in the room condition for 24 hrs																
High Temperature Storage	Temperature: 40±2°C Relative Humidity: 90 ~ 95% Time: 1000 hrs Measured after exposure in the room condition for 24 hrs																
Low Temperature Storage	Temperature: 85±3°C Applied Current: Rated Current Time: 1000 hrs Measured after exposure in the room condition for 24 hrs																
		Temperature: -25±3°C Time: 1000 hrs Measured after exposure in the room condition for 24 hrs															

■ Storage Temperature: 25±3°C; Humidity < 80%RH

■ Operating Temperature Range: -40~+85°C

Reflow

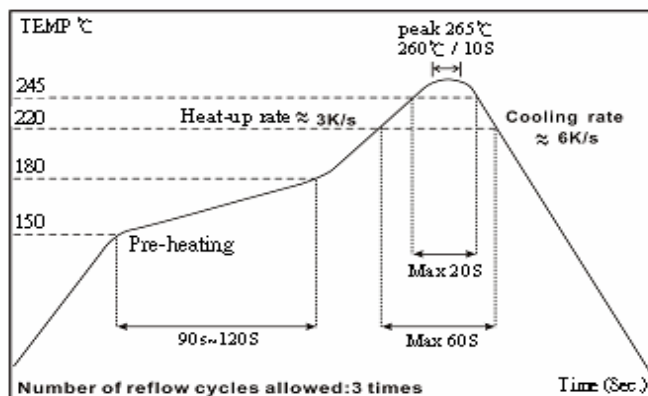

Packaging

Packaging Quantity & Reel Specifications

Type	ΦA	ΦB	ΦC	W	T	Quantity (EA)
NL03	178±2.0	60±0.5	13±0.3	9±0.3	12±1.0	4000
NL05	178±2.0	60±0.5	13±0.3	9±0.3	12±1.0	2000
NL08	178±2.0	60±0.5	13±0.3	9±0.3	12±1.0	2000
NL10	178±2.0	60±0.5	13±0.3	9±0.3	12±1.0	2000
NL12	178±2.0	80±0.5	13±0.3	13.2±0.3	16±1.0	500
NL20	330±2.0	100±0.5	13±0.3	17.4±0.3	22±1.0	1000

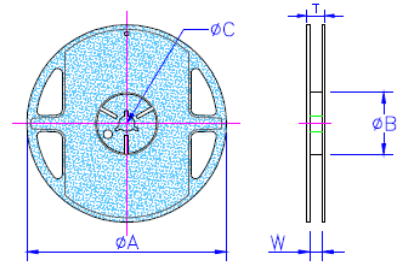

Embossed Plastic Tape Specifications

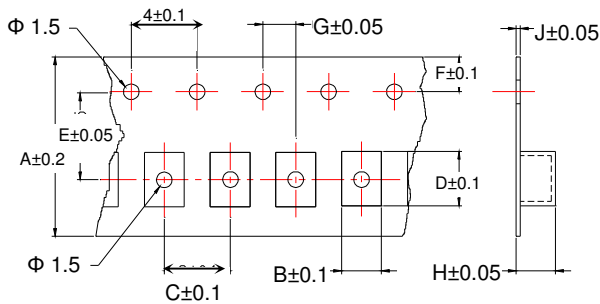

Unit: mm

Type	A	B	C	D	E	F	G	H	J
NL03	8	1.25	4	1.90	3.5	1.75	2	1.00	0.23
NL05	8	1.85	4	2.55	3.5	1.75	2	1.45	0.23
NL08	8	2.80	4	2.95	3.5	1.75	2	2.22	0.23
NL10	8	2.96	4	3.60	3.5	1.75	2	2.40	0.23
NL12	12	3.30	8	5.00	5.5	1.75	2	3.50	0.30
NL20	16	5.35	12	6.10	7.5	1.75	2	5.50	0.35

Leader / Trailer Tape

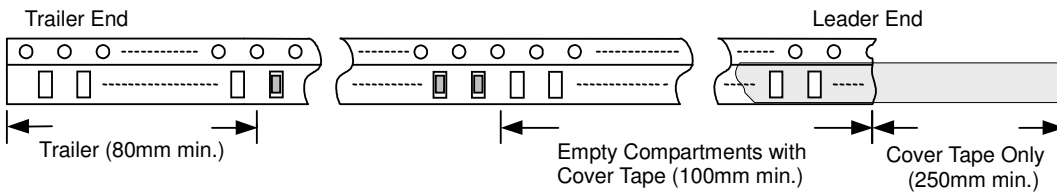

Cover Tape Peel Strength

The force for tearing off cover tape is 0.1~0.6 (N) in the arrow direction at the following conditions:

Temperature: 5~35°C

Humidity: 45~85%

Atmospheric Pressure: 860~1060 hpa

