

TOSHIBA

Leading Innovation >>>

Semiconductor Catalog Mar. 2016

Photocouplers and Photorelays

フォトカプラ・フォトリレー



SEMICONDUCTOR & STORAGE PRODUCTS

<http://toshiba.semicon-storage.com/>

Photocouplers are widely used in various electronic devices to isolate high-speed signals from noise-sensitive circuits. Toshiba's photocouplers consist of a high-intensity infrared light-emitting diode (LED) optically coupled to a photodetector fabricated using the latest process. The LED-photodetector couple is encapsulated in an electrically insulating resin with high transparency. Features of Toshiba's photocouplers include certification to many international safety standards, high isolation and low power consumption. They are suitable for applications requiring a high level of safety.

フォトカプラは最もポピュラーな絶縁素子として、多くの電子機器のノイズ保護に役立っています。当社のフォトカプラは、高出力赤外発光ダイオードと新世代プロセスを使用した受光チップを絶縁樹脂でパッケージ化しており、安全規格認証、高い絶縁性能、低消費電力などの特長で、安心・安全・エコロジーな機器システムに貢献します。

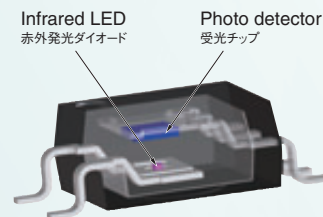

Photocoupler Package フォトカプラパッケージ

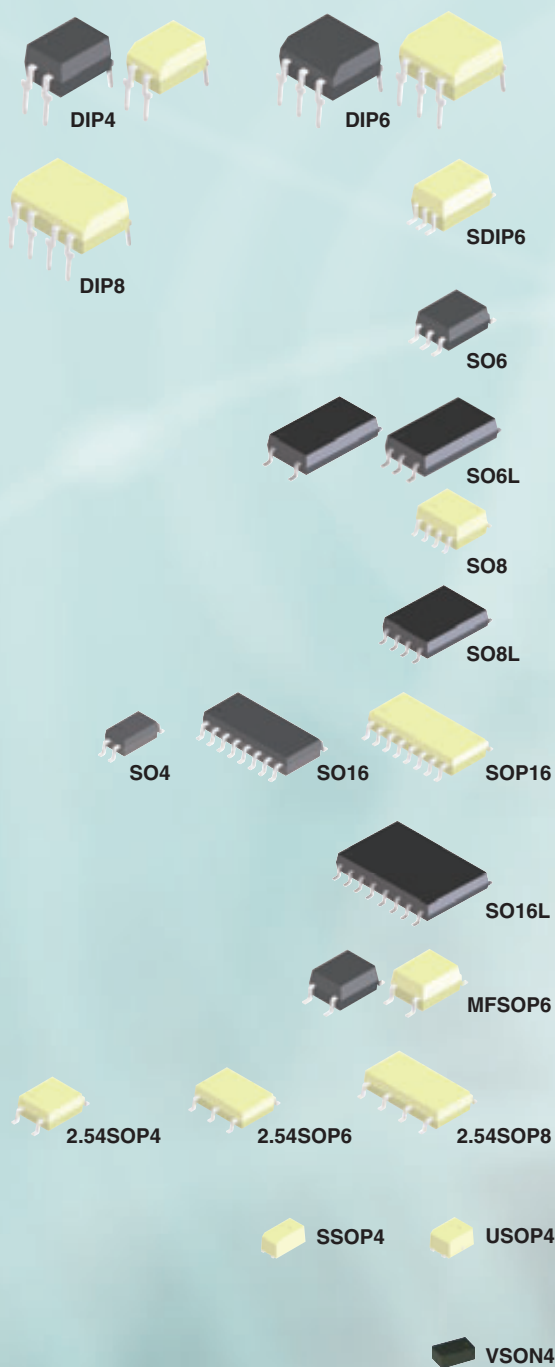

DIP4	DIP6	<ul style="list-style-type: none"> General-purpose packages Lead-forming options for surface mounting
DIP8		<ul style="list-style-type: none"> 汎用パッケージ 面実装リードフォーミング対応可能
SDIP6		<ul style="list-style-type: none"> ≥ 7 mm clearance / creepage; ≥ 0.4mm isolation thickness 6 pin thin SMD package (1.27 mm lead pitch) 沿面・空間距離 ≥ 7 mm、絶縁物厚さ ≥ 0.4 mm 6ピン薄型面実装パッケージ (リードピッチ 1.27 mm)
SO6		<ul style="list-style-type: none"> ≥ 5 mm clearance/creepage; ≥ 0.4 mm isolation thickness 6 pin thin SMD package (1.27 mm lead pitch) 沿面・空間距離 ≥ 5 mm、絶縁物厚さ ≥ 0.4 mm 6ピン薄型面実装パッケージ (リードピッチ 1.27 mm)
SO6L		<ul style="list-style-type: none"> ≥ 8 mm clearance/creepage; ≥ 0.4 mm isolation thickness 沿面・空間距離 ≥ 8 mm、絶縁物厚さ ≥ 0.4 mm
SO8		<ul style="list-style-type: none"> 8 pin SMD package (1.27 mm lead pitch) 8ピン面実装パッケージ (リードピッチ 1.27 mm)
SO8L		<ul style="list-style-type: none"> 8 pin thin SMD package (1.27 mm lead pitch) 8ピン薄型面実装パッケージ (リードピッチ 1.27 mm)
SO4		<ul style="list-style-type: none"> 4 pin SMD package (1.27 mm lead pitch) 16 pin SMD package (1.27 mm lead pitch)
SOP16	SO16	<ul style="list-style-type: none"> 4ピン面実装パッケージ (リードピッチ 1.27 mm) 16ピン面実装パッケージ (リードピッチ 1.27 mm)
SO16L		<ul style="list-style-type: none"> ≥ 8 mm clearance/creepage; ≥ 0.4 mm isolation thickness 16 pin SMD package (1.27 mm lead pitch) 沿面・空間距離 ≥ 8 mm、絶縁物厚さ ≥ 0.4 mm 16ピン面実装パッケージ (リードピッチ 1.27 mm)
MFSOP6		<ul style="list-style-type: none"> SMD package (1.27 mm lead pitch) 面実装パッケージ (リードピッチ 1.27 mm)
2.54SOP4	2.54SOP6	<ul style="list-style-type: none"> SMD package (2.54 mm lead pitch) 面実装パッケージ (リードピッチ 2.54 mm)
2.54SOP8		
SSOP4		<ul style="list-style-type: none"> Ultra-small SMD package (1.27 mm lead pitch)
USOP4		<ul style="list-style-type: none"> 超小型面実装パッケージ (リードピッチ 1.27 mm)
VSON4		<ul style="list-style-type: none"> SMD package (Very Small Outline Non-leaded) 超小型リードレス面実装パッケージ

Both photocouplers and photorelays consist of a light-emitting element and a light-receiving element in the same package. Their input and output signals are optically coupled with each other to provide electrical isolation. Photocouplers and photorelays are available with many output types to meet various interface needs.

フォトカップラ/フォトリレーは、発光素子と受光素子が一体化したデバイスです。入力側と出力側は電気的には絶縁されていますが、信号は光により伝達されます。出力タイプは次段のインタフェースに合わせて、多種取り揃えています。

**Photocoupler
Product Lineup**
フォトカップラ
製品ラインアップ

Isolation Amplifier
アイソレーションアンプ

Page 6

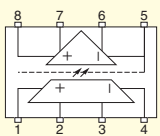
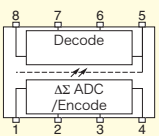



Analog Output Type
アナログ出力タイプ

Digital Output Type
デジタル出力タイプ

IC Output
IC 出力

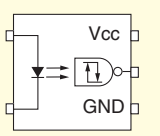
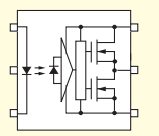
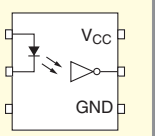
Page 7

High Speed Communications
高速通信用

IGBT/MOSFET Gate Drive
IGBT/MOSFET ゲート駆動用

IPM Drive
IPM 駆動用

Transistor Output
トランジスタ出力

Page 21

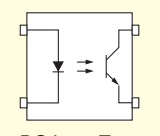

DC Input Type
DC 入力タイプ

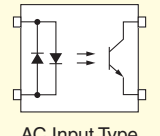

AC Input Type
AC 入力タイプ

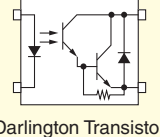

Darlington Transistor
Output Type
ダーリントントランジスタ出力タイプ

Triac Output
トライアック出力

Page 25

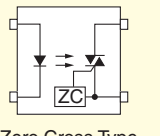
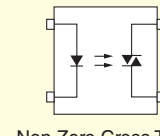



Zero Cross Type
ゼロクロス (ZC) タイプ

Non Zero Cross Type
非ゼロクロス (NZC) タイプ

Thyristor Output
サイリスタ出力

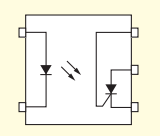
Page 29



Photovoltaic Output
フォトボル出力

Page 30

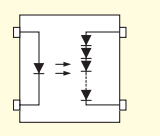
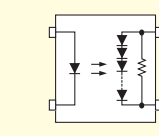



General-purpose
汎用タイプ

With discharge resistor
放電抵抗内蔵タイプ

Photorelays
フォトリレー

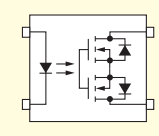
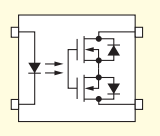
Page 31

Form-A contact
a 接点タイプ

Form-B contact
b 接点タイプ

New Product Digest 新製品ダイジェスト	Page 4
Package パッケージ	Page 44
Packing 包装	Page 52
Board Assembly 実装	Page 56

Device Degradation 使用上の留意点	Page 58
Safety Standard Approvals 海外安全規格認定	Page 64
Cross Reference 他社製品との互換表	Page 66
Part Number Index 品番索引	Page 70

New Product Digest

新製品ダイジェスト

Optical Isolation Amplifiers with Industry-Leading^(*) Linearity

業界トップクラス^(*)の高精度リニアリティを持った光結合型アイソレーションアンプ

TLP7820, TLP7920, TLP7830, TLP7930

In recent years, enhanced accuracy has been required for semiconductor devices for factory equipment applications, including servo amplifiers and AC drives. Its purpose is to provide accurate feedback to microcontrollers by monitoring motor phase current or bus voltage fluctuation. In order to satisfy this requirement, Toshiba's optical isolation amplifiers incorporate a $\Delta\Sigma$ AD converter circuit on the input side that features an industry-leading linearity performance. Optical isolation amplifiers with an analog output exhibit a typical nonlinearity of 0.02% (typ.), and those with a digital output achieve a nonlinearity of 4 LSB (typ.).

In addition, the high common-mode transient immunity of 20 kV/ μ s (typ.) makes the operation of these products reliable even in motor control applications that generate a lot of voltage noise. These products also feature an isolation voltage of 5 kVrms (min), making them suitable for various factory equipment applications.

Two types of packages are available: DIP8 and SO8L. The SO8L package has 30% less footprint and 40% less height than DIP8, contributing to the reduction of system size.

近年、サーボアンプ、インバータなどのFA機器はますます高精度の動作が求められ、モータの相電流やバス電圧変動をモニタして正確にマイコンにフィードバックすることが求められています。光結合型アイソレーションアンプはこれらの要求に応えるために、入力側に $\Delta\Sigma$ 型AD変換回路を備え、アナログ出力品で0.02%（標準）、デジタル出力品で4LSB（標準）と業界トップクラスの高精度リニアリティを実現しています。

また、20 kV/ μ s（標準）と高い同相過渡除去特性を持っており、高いノイズが発生するモータ制御用途でも安定した動作が得られます。そして絶縁耐圧5 kVrms（最小）を保証し、さまざまなFA応用に適応します。

パッケージは、DIP8とSO8Lの2種類をラインアップし、特にSO8LはDIP8に比べて実装面積を約30%、高さを約40%縮小することができ、セットの小型化に貢献します。

(*) Comparison with optical isolation amplifiers, according to a survey by Toshiba (as of October 2015)
 (*1) 光結合型アイソレーションアンプにおいて、東芝調べ（2015年10月時点）によるものです。

Features 特長

- Industry-leading linearity due to a $\Delta\Sigma$ AD converter circuit:
 NL₂₀₀ = 0.02 % (typ.) (analog output products)
 INL = 4 LSB (typ.) (digital output products)
- Low input supply current:
 I_{DD1} = 8.6 mA (typ.) (analog output products)
 I_{DD1} = 8.5 mA (typ.) (digital output products)
- High common-mode transient immunity (CMTI): 20 kV/ μ s (typ.)
- High isolation voltage (BVS): 5 kVrms (min)
- Small SO8L package
 (30% footprint reduction and 40% height reduction compared to DIP8)

- $\Delta\Sigma$ AD変換回路を内蔵し、業界トップクラスの高精度リニアリティを実現:
 NL₂₀₀ = 0.02 % (標準) (アナログ出力品)
 INL = 4 LSB (標準) (デジタル出力品)
- 低一次側供給電流:
 I_{DD1} = 8.6 mA (標準) (アナログ出力品)
 I_{DD1} = 8.5 mA (標準) (デジタル出力品)
- 高同相過渡除去: CMTI = 20 kV/ μ s (標準)
- 高絶縁耐圧: BVS = 5 kVrms (最小)
- 小型SO8Lパッケージ
 (DIP8パッケージに比べて、実装面積30%、高さ40%縮小)

Applications 用途

- Industrial equipment such as AC drives, servo amplifiers, robots, machine tools and large-capacity power supplies
- AC drives and industrial accumulators for wind and photovoltaic power generation applications
- Office equipment and household appliances (UPSs, power supplies for servers, accumulators for domestic use, and air conditioners)

- インバータ、サーボアンプ、ロボット、工作機械、大容量電源などの産業機器
- 風力/太陽光発電インバータ、産業用蓄電池
- UPS、サーバ用電源、家庭用蓄電池、エアコンなどの事務機器や住宅設備

Package パッケージ



Circuit Example 応用回路例

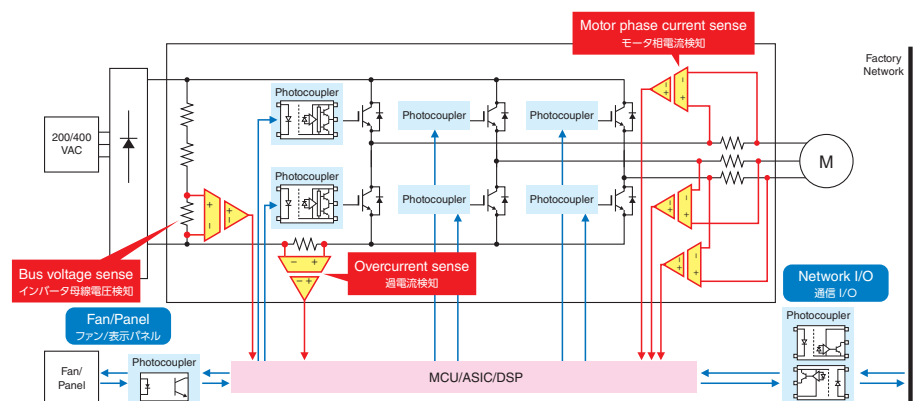

5-Mbps High-Speed Photocouplers with Ultra-Low Power Consumption for Communication Applications

超低消費電力 5 Mbps 高速通信用フォトカプラ

TLP2310, TLP2710

The TLP2310 and TLP2710 have 54% less power consumption than the conventional product^(*). These photocouplers consume a supply current (IDD/IDDH) of only 0.3 mA maximum over the entire operating temperature range of -40 to 125°C, and operate at a supply voltage as low as 2.7 V, contributing to reducing the power consumption of various systems. The input forward current can be less than 1 mA maximum, allowing direct drive by a microcontroller. They help reduce system power consumption and cost.

TLP2310/TLP2710は従来製品^(*)に比べて消費電力を54%低減しています。-40～125°Cの全動作温度範囲において、供給電流(IDDL/IDDH)が最大0.3 mAと極めて小さく、電源電圧も2.7 Vから動作が可能です。また、入力順電流も最大1 mA以下で駆動できるため、マイクロコントローラからの直接駆動も可能です。セットの小型・薄型化、低消費電力化に貢献します。

Features 特長

- 2.3-mm-thick (max) package
- Clearance and creepage distances of 8 mm (min) (TLP2710)
- Low threshold input current (I_{FLH}): 1 mA (max)
(Approx. 38% reduction compared to the conventional product^(*))
- Low supply current (I_{DDL}/I_{DDH}): 0.3 mA (max)
(Approx. 90% reduction compared to the conventional product^(*))
- Support for 3.3/5-V system power supplies (V_{DD}): 2.7 to 5.5 V
- LED with excellent lifetime characteristics
- High operating temperature (T_{opr} (max)): 125°C

- 厚さ 2.3 mm (最大) の薄型パッケージを採用
- 沿面・空間距離: 8 mm (最小) (TLP2710)
- 低スレッシュホルド入力電流: $I_{FLH} = 1$ mA (最大)
(従来製品^(*)比約38%低減)
- 低供給電流: $I_{DDL}/I_{DDH} = 0.3$ mA (最大)
(従来製品^(*)比約90%低減)
- 3.3 V/5 V系電源電圧対応: $V_{DD} = 2.7 \sim 5.5$ V
- 寿命特性に優れた高信頼性のLEDを採用
- 高温動作定格: T_{opr} (最大) = 125°C



Pin Configuration ピン接続図

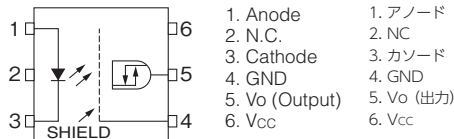

Applications 用途

- AC drivers
- Servo amplifiers
- Photovoltaics
- Factory networks
- I/O interface boards
- インバータ
- サーボアンプ
- 太陽光発電
- FA ネットワーク
- I/O インタフェース

(*) Conventional product: TLP2355 (5-pin SO6 package)
(*) 従来製品 TLP2355 (5pin SO6 パッケージ)

Low-PWD IC-Output Photocouplers for IPM Drive

低 PWD IPM 駆動用 IC フォトカプラ

TLP2745, TLP2748

The TLP2745 and TLP2748 are designed for Intelligent Power Module (IPM) drive applications, featuring low pulse width distortion (PWD), high speed, high temperature operation, and low power consumption. The TLP2745 is a noninverting photocoupler (high input → high output), and the TLP2748 is an inverting photocoupler (high input → low output). Because of a propagation delay time of 120 ns (max), the TLP2745 and TLP2748 allow the reduction of inverter dead time, contributing to the improvement of power efficiency. These products are well suited not only to IPM drives but also to communication interfaces (such as RS232, RS422 and RS485) including those for industrial applications, and data transmission solutions between circuits with different voltages.

TLP2745/TLP2748は低PWD(Pulse Width Distortion: パルス幅歪)、高速、高温動作、低消費電力を特長としたIPM(インテリジェントパワーモジュール)駆動用フォトカプラです。TLP2745はバッファロジックタイプ(入力High→出力High)、TLP2748はインバータロジックタイプ(入力High→出力Low)です。伝搬遅延時間が最大120 nsと高速対応しているため、インバータのデッドタイムが短縮でき、電力効率の向上に貢献します。IPM駆動だけでなく、産業用途をはじめとする通信インタフェース(RS232、RS422、RS485など)や、異なる電圧回路間のさまざまなデータ通信ソリューションにも使用できます。

Features 特長

- Operating temperature range: -40 to 110°C
- Data transfer rate: 10 Mbps (typ.) (NRZ)
- Threshold input current: 1.6 mA (max)
- Supply current: 3 mA (max)
- Common-mode transient immunity: ± 30 kV/ μ s (min)

- 動作温度範囲: -40～110°C
- 伝送レート: 10 Mbps (typ.) (NRZ)
- スレッシュホルド入力電流: 1.6 mA (最大)
- 供給電流: 3 mA (最大)
- 瞬時コモンモード除去電圧: ± 30 kV/ μ s (最小)



Pin Configuration ピン接続図

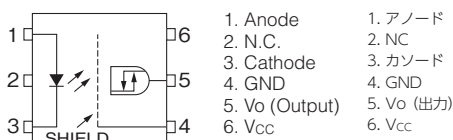

Applications 用途

- Factory equipment (for IPM drive)
- High-speed digital interface for measurement or control devices
- Programmable logic controllers
- FA 機器 (IPM 駆動用)
- 計測器・制御装置などの高速デジタルインタフェース
- プログラマブルコントローラ

Product Lineup

製品ラインアップ

Isolation Amplifier アイソレーションアンプ

Selection Table 製品選択表

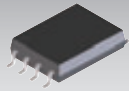
		
Output Configuration 出力形態	SO8L	DIP8 (F type)
Analog Output Type アナログ出力タイプ	TLP7820 *	TLP7920 * TLP7920F *
Digital Output type デジタル出力タイプ	TLP7830 *	TLP7930 * TLP7930F *

*: New product / 新製品

Selection Guide 製品一覧表

Analog Output Type アナログ出力タイプ

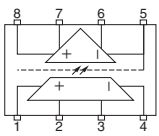
Part Number 品番	Pin Configuration ピン接続図	Features 特長	Gain Error Rank 利得誤差ランク (Ta=25°C) (%) max	Non Linearity INL ₂₀₀ 出力 非線形アリティ (Ta=25°C) (%) typ.	Input Offset Voltage 入力オフセット 電圧 (mV) typ.	Supply Current 供給電流		BVs @ 1 min. 絶縁耐圧 (Vrms)	Safety Standards ⁽¹⁾ 安全規格				
						Input 入力 I _{DD1} (mA) max	Output 出力 I _{DD2} (mA) max		UL	c-UL	VDE		CQC
											EN 60747-5-5	EN 60065 EN 60950-1	
TLP7820 *		SO8L • Gain = 8.2 (typ.) • Topr = 105°C (max) • 利得 8.2 (typ.) • 動作周囲温度 105°C対応	±0.5 ±1.0 ±3.0	0.02	0.9	12	10	5000	○	○	○	○	△
TLP7920 * TLP7920F *		DIP8 • Gain = 8.2 (typ.) • Topr = 105°C (max) • 利得 8.2 (typ.) • 動作周囲温度 105°C対応			0.73				○	○	○	○	△

*: New product / 新製品

Digital Output Type デジタル出力タイプ

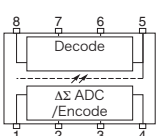
Part Number 品番	Pin Configuration ピン接続図	Features 特長	SNDR 信号対 (雑音+歪)比 (Ta=25°C) (dB) typ.	SNR 信号対 雑音比 (Ta=25°C) (dB) typ.	Output Clock Frequency 出力クロック 周波数 (MHz) typ.	Supply Current 供給電流		BVs @ 1 min. 絶縁耐圧 (Vrms)	Safety Standards ⁽¹⁾ 安全規格				
						Input 入力 I _{DD1} (mA) max	Output 出力 I _{DD2} (mA) max		UL	c-UL	VDE		CQC
											EN 60747-5-5	EN 60065 EN 60950-1	
TLP7830 *		SO8L • 1bit digital & CLK output • Topr = 105°C (max) • 1ビットデータ列および クロックを出力 • 動作周囲温度 105°C対応	75	80	10	12	8.0	5000	○	○	○	○	△
TLP7930 * TLP7930F *		DIP8 • 1bit digital & CLK output • Topr = 105°C (max) • 1ビットデータ列および クロックを出力 • 動作周囲温度 105°C対応							○	○	○	○	△







Note (1): Please refer to page 43. P.43 をご参照ください。



*: New product / 新製品

SNDR: Signal to Noise and Distortion Ratio
SNR: Signal to Noise Ratio

IC Output <High Speed Communications> IC 出力 <高速通信用>

Selection Table 製品選択表

Data Rate 伝送レート (Typ.)	Output 出力形態								
		5 pin MFSOP6	4 pin SO6	5 pin SO6	1ch	2ch	SO6L	(F type)	
20 kbit/s	Open-collector オープンコレクタ		TLP2301				TLP2701 *		
100 to 300 kbit/s	Open-collector オープンコレクタ			TLP2303	TLP2403		TLP2703 *		
1 Mbit/s	Open-collector オープンコレクタ			TLP109 TLP2309	TLP2409				
	IPM drive IPM 駆動			TLP104 TLP109 (IGM)	TLP2404		TLP2704 **	TLP714 TLP719	TLP714F TLP719F
5 Mbit/s	Totem-pole トータムポール出力	TLP2095 TLP2098		TLP2310 *		TLP2110 ** TLP2105 TLP2108	TLP2710 *		
	AC input AC 入力			TLP2395 * TLP2398 *					
	IPM drive IPM 駆動			TLP2355 TLP2358	TLP2405 TLP2408			TLP715 TLP718	TLP715F TLP718F
10 Mbit/s	Open-collector オープンコレクタ			TLP2362					
	Totem-pole トータムポール出力			TLP2391 *					
15 Mbit/s	IPM drive IPM 駆動			TLP2345 * TLP2348 *			TLP2745 ** TLP2748 **		
	Open-collector オープンコレクタ					TLP2118E		TLP708	TLP708F
20 Mbit/s	Totem-pole トータムポール出力			TLP2361 *		TLP2116 TLP2161 * TLP2166A	TLP2761 *	TLP716	TLP716F
	Open-collector オープンコレクタ			TLP118 TLP2368	TLP2418 TLP2468	TLP2168	TLP2768A *	TLP2768	TLP2768F
50 Mbit/s	Totem-pole トータムポール出力	TLP2066		TLP116A TLP2366 TLP2370	TLP2466	TLP2160		TLP2766	TLP2766F
	Totem-pole トータムポール出力	TLP117		TLP2367 **	TLP2167 **		TLP2767 **		

Data Rate 伝送レート (Typ.)	Output 出力形態						
		DIP6	1ch	(F type)	2ch	(F type)	JEDEC Type JEDEC 対応
100 to 300 kbit/s	Open-collector オープンコレクタ		TLP553				6N138 6N139
1 Mbit/s	Open-collector オープンコレクタ	TLP512	TLP550 TLP551 TLP559 TLP651 TLP750 TLP751 TLP759	TLP750F TLP751F TLP759F	TLP2530 TLP2531		6N135 6N136
	IPM drive IPM 駆動		TLP559 (IGM) TLP754 TLP759 (IGM)	TLP754F TLP759F (IGM)			
2.5 Mbit/s	3-state 3 ステート出力		TLP2200				
5 Mbit/s	Totem-pole トータムポール出力		TLP555 TLP558				
	IPM drive IPM 駆動		TLP2955 TLP2958	TLP2955F TLP2958F			
10 Mbit/s	Open-collector オープンコレクタ		TLP552 TLP554 TLP2601 TLP2962 TLPN137	TLP2962F	TLP2630 TLP2631 TLP2662	TLP2662F	6N137

■: Photocouplers with a maximum operating temperature (Topr.) of 125°C / 動作周囲温度 125°C (max) 対応品

■: Photocouplers with low input current. / 低入力電流品

*: New product / 新製品 **: Under development / 開発中

Selection Guide 製品一覧表

Data Rate: 20 k bps (Typ.) 伝送レート 20 k bps (標準)

Part Number 品番	Pin Configuration ピン接続図	Features 特長	Propagation Delay Time 伝播遅延時間 (max)		CTR 変換効率		BVs @ 1min. 絶縁耐圧 (Vrms)	Safety Standards ⁽¹⁾ 安全規格				
			t _{pHL} (μ s)	t _{pLH} (μ s)	min (%)	@ I _F (mA)		UL	c-UL	VDE		CQC
										EN 60747-5-5	EN 60065 EN 60950-1	
TLP2301		4 pin SO6 ・ Reinforced insulation ・ Low input drive current ・ 強化絶縁対応 ・ 低入力駆動 ・ Data Rate (Typ. @NRZ) 20 k bps	30	30	50	1	3750	○	○	○	○	○
TLP2701 *		4 pin SO6L ・ Topr (max) 125°C ・ Reinforced insulation ・ Low input drive current ・ 強化絶縁対応 ・ 低消費電力 ・ Data Rate (Typ. @NRZ) 20 k bps	30	30	50	1	5000	△	△	△	△	△

*: New product / 新製品

Data Rate: 100 k / 300 k bps (Typ.) 伝送レート 100 k / 200 l bps (標準)

Part Number 品番	Pin Configuration ピン接続図	Features 特長	Propagation Delay Time 伝播遅延時間 (max)		CTR 変換効率		BVs @ 1min. 絶縁耐圧 (Vrms)	Safety Standards ⁽¹⁾ 安全規格				
			t _{pHL} (μ s)	t _{pLH} (μ s)	min (%)	@ I _F (mA)		UL	c-UL	VDE		CQC
										EN 60747-5-5	EN 60065 EN 60950-1	
TLP2303		5 pin SO6 ・ Reinforced insulation ・ Low input drive current ・ 強化絶縁対応 ・ 低入力駆動 ・ Data Rate (Typ. @NRZ) 100 k bps	15	50	900	0.5	3750	○	○	○	○	○
TLP2703 *		SO6L ・ Reinforced insulation ・ Low input drive current ・ 強化絶縁対応 ・ 低入力駆動 ・ Data Rate (Typ. @NRZ) 100 k bps					5000	○	○	○	○	△
TLP553		DIP8 ・ Low input drive current ・ 低入力駆動 ・ Data Rate (Typ. @NRZ) 300 k bps	25	60	400	0.5	2500	○				
TLP2403		SO8 ・ SO8 version of the TLP553 ・ TLP553のSO8パッケージタイプ ・ Data Rate (Typ. @NRZ) 300 k bps					3750	○	○	○		

*: New product / 新製品

Data Rate: 1 M bps (Typ.) 伝送レート 1 M bps (標準)

Part Number 品番	Pin Configuration ピン接続図	Features 特長	Propagation Delay Time 伝播遅延時間 (max)		CTR 変換効率		BVs @ 1min. 絶縁耐圧 (Vrms)	Safety Standards ⁽¹⁾ 安全規格				
			t _{pHL} (μ s)	t _{pLH} (μ s)	min (%)	@ I _F (mA)		UL	c-UL	VDE		CQC
										EN 60747-5-5	EN 60065 EN 60950-1	
TLP109		5 pin SO6 ・ Reinforced insulation ・ 強化絶縁対応 ・ Data Rate (Typ. @NRZ) 1 M bps	0.8	0.8	20	16	3750	○	○	○	○	○
TLP512		DIP6 ・ DIP6 package version of the TLP550 ・ TLP550の6ピンタイプ ・ Data Rate (Typ. @NRZ) 1 M bps					2500	○				
TLP550		DIP8 ・ High CMR ・ 高CMR ・ Data Rate (Typ. @NRZ) 1 M bps	0.8	2	10 (19% min for rank O)		○	○				

Note (1): Please refer to page 43. P.43をご参照ください。

(Data Rate: 1 M bps (Typ.) 伝送レート 1 M bps (標準))

Part Number 品番	Pin Configuration ピン接続図	Features 特長	Propagation Delay Time 伝播遅延時間 (max)		CTR 変換効率		BVs @ 1min. 絶縁耐圧 (Vrms)	Safety Standards ⁽¹⁾ 安全規格				
			t _{pHL} (μ s)	t _{pLH} (μ s)	min (%)	@ I _F (mA)		UL	c-UL	VDE		CQC
										EN 60747-5-5	EN 60065 EN 60950-1	
TLP551		DIP8 <ul style="list-style-type: none"> Internal base connection ベース接続あり Data Rate (Typ. @NRZ) 1 M bps 	0.8	2	10 (19% min for rank O)		2500	○	○			
TLP559		DIP8 <ul style="list-style-type: none"> High CMR version of the TLP550 TLP550 の高 CMR タイプ Data Rate (Typ. @NRZ) 1 M bps 	0.8	0.8	20			○	○			
TLP651		DIP8 <ul style="list-style-type: none"> High isolation voltage Internal base connection 高絶縁耐圧 ベース接続あり Data Rate (Typ. @NRZ) 1 M bps 	0.8	2.0	10 (19% min for rank O)		5000	○	○			
TLP719 TLP719F		SDIP6 <ul style="list-style-type: none"> Direct drive of an IPM Data Rate (Typ. @NRZ) 1 M bps IPM 直接駆動 	0.8	0.8	20	16		○	○	○		
TLP750 TLP750F		DIP8 <ul style="list-style-type: none"> High isolation voltage SEMKO-approved 高絶縁耐圧 SEMKO 認定品 Data Rate (Typ. @NRZ) 1 M bps 	0.8	2	10 (19% min for rank O)		5000	○	○	○		
TLP751 TLP751F		DIP8 <ul style="list-style-type: none"> Internal base connection SEMKO-approved ベース接続あり SEMKO 認定品 Data Rate (Typ. @NRZ) 1 M bps 	0.2 (Typ.)	1.0 (Typ.)	10			○	○	○		
TLP759 TLP759F		DIP8 <ul style="list-style-type: none"> IEC60950 design standard version of the TLP559 SEMKO-approved TLP559 の IEC60950 適合品 SEMKO 認定品 Data Rate (Typ. @NRZ) 1 M bps 	0.8	0.8	20		○	○	○			
TLP2309		5 pin SO6 <ul style="list-style-type: none"> Reinforced insulation 3.3-V/5.0-V power supplies 強化絶縁対応 電源電圧 3.3-V/5.0-V Data Rate (Typ. @NRZ) 1 M bps 	1.0	1.0	15	10	○	○	○	○	○	
TLP2409		SO8 <ul style="list-style-type: none"> Topr = 125°C (max) SO8 version of the TLP109 TLP109 の SO8 パッケージタイプ 動作周囲温度 125°C 対応 Data Rate (Typ. @NRZ) 1 M bps 	0.8	0.8	20		3750	○	○	○		
TLP2530		DIP8 <ul style="list-style-type: none"> Dual channel version of the 6N135 and the TLP550 6N135, TLP550 の 2 回路タイプ Data Rate (Typ. @NRZ) 1 M bps 	1.5	1.5	7	16		○	○			
TLP2531		DIP8 <ul style="list-style-type: none"> Dual channel version of the 6N135 and the TLP550 6N136, TLP550 の 2 回路タイプ Data Rate (Typ. @NRZ) 1 M bps 	0.8	0.8	19		○	○				

Note (1): Please refer to page 43. P.43 をご参照ください。

Data Rate: 2.5 M bps (Typ.) 伝送レート 2.5 M bps (標準)

Part Number 品番	Pin Configuration ピン接続図	Features 特長	Propagation Delay Time 伝播遅延時間 (max)		Output Form 出力形態	BV _s @ 1 min. 絶縁耐圧 (Vrms)	Safety Standards ⁽¹⁾ 安全規格					
			t _{pHL} (μs)	t _{pLH} (μs)			@ I _F (mA)	UL	c-UL	VDE EN 60747-5-5 EN 60950-1	EN 60065 EN 60950-1	CQC
TLP2200		DIP8 <ul style="list-style-type: none"> Low input current 低入力電流 Data Rate (Typ. @NRZ) 2.5 M bps 	0.4	0.4	3-state output (Buffer logic) 3ステート出力 (バッファロジック)	I _{FLH} = 1.6 (max)	2500	○	○			

Data Rate: 5 M bps (Typ.) 伝送レート 5 M bps (標準)

Part Number 品番	Pin Configuration ピン接続図	Features 特長	Propagation Delay Time 伝播遅延時間 (max)		Output Form 出力形態	BV _s @ 1 min. 絶縁耐圧 (Vrms)	Safety Standards ⁽¹⁾ 安全規格						
			t _{pHL} (μs)	t _{pLH} (μs)			@ I _F (mA)	UL	c-UL	VDE EN 60747-5-5 EN 60950-1	EN 60065 EN 60950-1	CQC	
TLP555		DIP8 <ul style="list-style-type: none"> Low input current V_{cc} = 4.5 to 20 V With enable pin 	0.4	0.4	3-state output (Buffer logic) 3ステート出力 (バッファロジック)	I _{FLH} = 1.6 (max)	2500	○	○				
TLP558		<ul style="list-style-type: none"> 低入力電流 Data Rate (Typ. @NRZ) 5 M bps イネーブル端子付き 			3-state output (Inverter logic) 3ステート出力 (インバータロジック)								I _{FLH} = 1.6 (max)
TLP715 TLP715F		SDIP6 <ul style="list-style-type: none"> Direct drive of an IPM IPM 直接駆動 Data Rate (Typ. @NRZ) 5 M bps 	0.25	0.25	Totem pole output (Buffer logic) トータムポール出力 (バッファロジック)	I _{FLH} = 3 (max)	5000	○	○	○			
TLP718 TLP718F		<ul style="list-style-type: none"> IPM 直接駆動 Data Rate (Typ. @NRZ) 5 M bps 			Totem pole output (Inverter logic) トータムポール出力 (インバータロジック)								I _{FLH} = 3 (max)
TLP2095		5 pin MFSOP6 <ul style="list-style-type: none"> AC input V_{cc} = 3.0 to 20 V 			Totem pole output (Buffer logic) トータムポール出力 (バッファロジック)								I _{FLH} = ± 3.0
TLP2098		<ul style="list-style-type: none"> AC 入力 Data Rate (Typ. @NRZ) 5 M bps 			Totem pole output (Inverter logic) トータムポール出力 (インバータロジック)								I _{FLH} = ± 3.0
TLP2105		SO8 <ul style="list-style-type: none"> Dual channel 	0.25	0.25	Totem pole output (Buffer logic) トータムポール出力 (バッファロジック)	I _{FLH} = 1.6 (max)	2500	○	○	○			
TLP2108		<ul style="list-style-type: none"> 2回路タイプ Data Rate (Typ. @NRZ) 5 M bps 			Totem pole output (Inverter logic) トータムポール出力 (インバータロジック)								I _{FLH} = 1.6 (max)
TLP2110 *		SO8 <ul style="list-style-type: none"> Dual channel version of the TLP2310 TLP2310の2回路タイプ Data Rate (Typ. @NRZ) 5 M bps 			Totem pole output (Buffer logic) トータムポール出力 (バッファロジック)								I _{FLH} = 1.0 (max)
TLP2310 *		5 pin SO6 <ul style="list-style-type: none"> Reinforced insulation Ultra low consumption 強化絶縁対応 超低消費電力 Data Rate (Typ. @NRZ) 5 M bps 	0.25	0.25	Totem pole output (Buffer logic) トータムポール出力 (バッファロジック)	I _{FLH} = 1.0 (max)	3750	○	○	○	○	○	
TLP2355		<ul style="list-style-type: none"> Reinforced insulation Direct drive of an IPM 強化絶縁対応 IPM 直接駆動 Data Rate (Typ. @NRZ) 5 M bps 			Totem pole output (Buffer logic) トータムポール出力 (バッファロジック)								I _{FLH} = 1.6 (max)

Note (1): Please refer to page 43. P.43 をご覧ください。

*: New product / 新製品

(Data Rate: 5 M bps (Typ.)) 伝送レート 5 M bps (標準)

Part Number 品番	Pin Configuration ピン接続図	Features 特長	Propagation Delay Time 伝播遅延時間 (max)		Output Form 出力形態	BV _s @ 1min. 絶縁耐圧 (Vrms)	Safety Standards ⁽¹⁾ 安全規格					
			t _{pHL} (μs)	t _{pLH} (μs)			@ I _F (mA)	UL	c-UL	VDE		CQC
										EN 60747-5-5	EN 60065 EN 60950-1	
TLP2358		5 pin SO6 ・ Reinforced insulation ・ Direct drive of an IPM ・ 強化絶縁対応 ・ IPM 直接駆動 ・ Data Rate (Typ. @NRZ) 5 M bps	0.25	0.25	Totem pole output (Inverter logic) トータムポール出力 (インバータロジック)	3750	○	○	○	○	○	
TLP2395 *		5 pin SO6 ・ AC input version of the TLP2355 ・ TLP2355 の AC 入力タイプ ・ Data Rate (Typ. @NRZ) 5 M bps			Totem pole output (Buffer logic) トータムポール出力 (バッファロジック)							
TLP2398 *		5 pin SO6 ・ AC input version of the TLP2355 ・ TLP2358 の AC 入力タイプ ・ Data Rate (Typ. @NRZ) 5 M bps			Totem pole output (Inverter logic) トータムポール出力 (インバータロジック)							
TLP2405		SO8 ・ Low input current ・ Direct drive of an IPM ・ 低入力電流 ・ IPM 直接駆動 ・ Data Rate (Typ. @NRZ) 5 M bps			Totem pole output (Buffer logic) トータムポール出力 (バッファロジック)							
TLP2408		SO8 ・ Low input current ・ Direct drive of an IPM ・ 低入力電流 ・ IPM 直接駆動 ・ Data Rate (Typ. @NRZ) 5 M bps			Totem pole output (Inverter logic) トータムポール出力 (インバータロジック)							
TLP2710 *		SO6L ・ SO6L version of the TLP2310 ・ TLP2310 の SO6L パッケージタイプ ・ Data Rate (Typ. @NRZ) 5 M bps			Totem pole output (Buffer logic) トータムポール出力 (バッファロジック)							
TLP2955 TLP2955F		DIP8 ・ Topr = 125°C (max) ・ Low input current ・ Vcc = 3.0 ~ 20-V ・ Direct drive of an IPM ・ 動作周囲温度 125°C 対応 ・ 低入力電流 ・ IPM 直接駆動 ・ Data Rate (Typ. @NRZ) 5 M bps			Totem pole output (Buffer logic) トータムポール出力 (バッファロジック)							
TLP2958 TLP2958F		DIP8 ・ Topr = 125°C (max) ・ Low input current ・ Vcc = 3.0 ~ 20-V ・ Direct drive of an IPM ・ 動作周囲温度 125°C 対応 ・ 低入力電流 ・ IPM 直接駆動 ・ Data Rate (Typ. @NRZ) 5 M bps			Totem pole output (Inverter logic) トータムポール出力 (インバータロジック)							

*: New product / 新製品

Data Rate: 10 M bps (Typ.) 伝送レート 10 M bps (標準)

Part Number 品番	Pin Configuration ピン接続図	Features 特長	Propagation Delay Time 伝播遅延時間 (max)		Output Form 出力形態	BV _s @ 1min. 絶縁耐圧 (Vrms)	Safety Standards ⁽¹⁾ 安全規格					
			t _{pHL} (μs)	t _{pLH} (μs)			@ I _F (mA)	UL	c-UL	VDE		CQC
										EN 60747-5-5	EN 60065 EN 60950-1	
TLP552		DIP8 ・ High-speed ・ 高速タイプ ・ Data Rate (Typ. @NRZ) 10 M bps	0.12	0.12	Open-collector output (Inverter logic) オープンコレクタ出力 (インバータロジック)	2500	○	○	○	○	○	
TLP554		DIP8 ・ High-speed ・ High CMR version of the TLP552 ・ 高速タイプ ・ TLP552 の高 CMR タイプ ・ Data Rate (Typ. @NRZ) 10 M bps										Totem pole output (Inverter logic) トータムポール出力 (インバータロジック)
TLP2345 *		5 pin SO6 ・ Reinforced insulation ・ High-speed ・ Direct drive of an IPM ・ 強化絶縁対応 ・ 高速 ・ IPM 直接駆動 ・ Data Rate (Typ. @NRZ) 10 M bps			Totem pole output (Buffer logic) トータムポール出力 (バッファロジック)							

Note (1): Please refer to page 43. P.43 をご参照ください。

*: New product / 新製品

(Data Rate: 10 M bps (Typ.) 伝送レート 10 M bps (標準))

Part Number 品番	Pin Configuration ピン接続図	Features 特長	Propagation Delay Time 伝播遅延時間 (max)		Output Form 出力形態	@ I _F (mA)	BVs @ 1 min. 絶縁耐圧 (Vrms)	Safety Standards ⁽¹⁾ 安全規格				
			t _{pHL} (μs)	t _{pLH} (μs)				UL	c-UL	VDE		CQC
								EN 60747-5-5	EN 60065 EN 60950-1			
TLP2348 *		5 pin SO6 ・ Reinforced insulation ・ High-speed ・ Direct drive of an IPM ・ 強化絶縁対応 ・ 高速 ・ IPM 直接駆動 ・ Data Rate (Typ. @NRZ) 10 M bps	0.12	0.12	Totem-pole output (Inverter logic) トータムポール出力 (インバータロジック)	I _{FHL} = 1.6 (max)	3750	○	○	○	○	
TLP2362		5 pin SO6 ・ Reinforced insulation ・ Vcc = 2.7-V/5.5-V ・ Topr (max) 125°C ・ 強化絶縁対応 ・ 動作周囲温度 125°C 対応 ・ Data Rate (Typ. @NRZ) 10 M bps	0.1	0.1	Open-collector output (Inverter logic) オープンコレクタ出力 (インバータロジック)	I _{FHL} = 5.0 (max)		○	○	○	○	○
TLP2391 *		5 pin SO6 ・ Reinforced insulation ・ Vcc = 3.3-V/5-V ・ Topr (max) 125°C ・ 強化絶縁対応 ・ 動作周囲温度 125°C 対応 ・ Data Rate (Typ. @NRZ) 10 M bps			Totem-pole output (Inverter logic) トータムポール出力 (インバータロジック)	I _{FHL} = ±2.5 (max)		○	○	○	○	
TLP2601		DIP8 ・ High-speed ・ High CMR ・ With enable pin ・ 高速タイプ ・ 高 CMR タイプ ・ イネーブル端子付き ・ Data Rate (Typ. @NRZ) 10 M bps			0.075	0.075	Open-collector output (Inverter logic) オープンコレクタ出力 (インバータロジック)	I _{FHL} = 5.0 (max)	2500	○	○	
TLP2630		DIP8 ・ Dual channel version of the 6N137 and the TLP552 ・ 6N137 および TLP552 の 2 回路タイプ ・ Data Rate (Typ. @NRZ) 10 M bps	○	○								
TLP2631		DIP8 ・ Dual channel version of the TLP554 ・ TLP554 の 2 回路タイプ ・ Data Rate (Typ. @NRZ) 10 M bps	○	○								
TLP2662 TLP2662F		DIP8 ・ Vcc = 3.3-V/5-V ・ Topr (max) 125°C ・ Dual channel version of the TLP2962 ・ TLP2962 の 2 回路タイプ ・ 動作周囲温度 125°C 対応 ・ Data Rate (Typ. @NRZ) 10 M bps					○	○	○	○		
TLP2745 *		SO6L ・ Reinforced insulation ・ High-speed ・ Direct drive of an IPM ・ SO6L version of the TLP2345 ・ 強化絶縁対応 ・ 高速タイプ ・ TLP2345 の SO6L パッケージタイプ ・ Data Rate (Typ. @NRZ) 10 M bps	0.12	0.12	Totem-pole output (Buffer logic) トータムポール出力 (バッファロジック)	I _{FHL} = 1.6 (max)	5000	○	○	○	○	
TLP2748 *		SO6L ・ Reinforced insulation ・ High-speed ・ Direct drive of an IPM ・ SO6L version of the TLP2348 ・ 強化絶縁対応 ・ 高速タイプ ・ TLP2348 の SO6L パッケージタイプ ・ Data Rate (Typ. @NRZ) 10 M bps			Totem-pole output (Inverter logic) トータムポール出力 (インバータロジック)	I _{FHL} = 1.6 (max)		○	○	○	○	
TLP2962 TLP2962F		DIP8 ・ Vcc = 3.3-V/5-V ・ Topr (max) 125°C ・ 動作周囲温度 125°C 対応 ・ Data Rate (Typ. @NRZ) 10 M bps	0.075	0.075	Open-collector output (Inverter logic) オープンコレクタ出力 (インバータロジック)	I _{FHL} = 5.0 (max)		○	○	○	○	

Note (1): Please refer to page 43. P.43 をご参照ください。

*: New product / 新製品

(Data Rate: 10 M bps (Typ.) 伝送レート 10 M bps (標準))

Part Number 品番	Pin Configuration ピン接続図	Features 特長	Propagation Delay Time 伝播遅延時間 (max)		Output Form 出力形態	BVs @ 1min. 絶縁耐圧 (Vrms)	Safety Standards ⁽¹⁾ 安全規格					
			t _{pHL} (μ s)	t _{pLH} (μ s)			@ I _F (mA)	UL	c-UL	VDE EN 60747-5-5 EN 60950-1	EN 60065 EN 60950-1	CQC
TLPN137		DIP8 ・ High-speed ・ 高速タイプ ・ Data Rate (Typ. @NRZ) 10 M bps	0.1	0.1	Open-collector output (Inverter logic) オープンコレクタ出力 (インバータロジック)	I _{FHL} = 5.0 (max)	5000	○	○	○	○	

(Data Rate: 15 M bps (Typ.) 伝送レート 15 M bps (標準))

Part Number 品番	Pin Configuration ピン接続図	Features 特長	Propagation Delay Time 伝播遅延時間 (max)		Output Form 出力形態	BVs @ 1min. 絶縁耐圧 (Vrms)	Safety Standards ⁽¹⁾ 安全規格					
			t _{pHL} (μ s)	t _{pLH} (μ s)			@ I _F (mA)	UL	c-UL	VDE EN 60747-5-5 EN 60950-1	EN 60065 EN 60950-1	CQC
TLP708 TLP708F		SDIP6 ・ Topr (max)125°C ・ High-speed ・ SDIP version of the TLP118 ・ 高速タイプ ・ 動作周囲温度 125°C対応 ・ TLP118のSDIPパッケージタイプ ・ Data Rate (Typ. @NRZ) 15 M bps	0.075	0.075	Open-collector output (Inverter logic) オープンコレクタ出力 (インバータロジック)	I _{FHL} = 5.0 (max)	5000	○	○	○		
TLP716 TLP716F		SDIP6 ・ High-speed ・ SDIP version of the TLP116A ・ 高速タイプ ・ TLP116AのSDIPパッケージタイプ ・ Data Rate (Typ. @NRZ) 15 M bps			Totempole output (Inverter logic) トータムポール出力 (インバータロジック)	I _{FHL} = 6.5 (max)		○	○	○		
TLP2116		SO8 ・ Dual channel version equivalent of the TLP116A ・ TLP116A相当の2回路タイプ ・ Data Rate (Typ. @NRZ) 15 M bps	0.08	0.08	Totempole output (Inverter logic) トータムポール出力 (インバータロジック)	I _{FHL} = 5.0 (max)	2500	○	○	○		
TLP2118E		SO8 ・ Dual channel version equivalent of the TLP118 ・ TLP118相当の2回路タイプ ・ Data Rate (Typ. @NRZ) 15 M bps						Open-collector output (Inverter logic) オープンコレクタ出力 (インバータロジック)	○	○	○	
TLP2161 *		SO8 ・ Vcc = 3.3-V/5-V power supplies ・ Topr (max)125°C ・ Data Rate (Typ. @NRZ) 15 M bps	0.075	0.075	Totempole output (Inverter logic) トータムポール出力 (インバータロジック)	I _{FHL} = 1.6 (max)	5000	○	○	○		
TLP2166A		SO8 ・ Vcc = 3.0-V/3.6-V ・ Dual channel version equivalent of the TLP2366 ・ TLP2366相当の2回路タイプ ・ Data Rate (Typ. @NRZ) 15 M bps				I _{FHL} = 3.0 (max)		○	○	○		
TLP2361 *		5 pin SO6 ・ Reinforced insulation ・ Vcc = 2.7-V/5.5-V ・ Topr (max)125°C ・ 強化絶縁対応 ・ 動作周囲温度 125°C対応 ・ Data Rate (Typ. @NRZ) 15 M bps	0.08	0.08	Totempole output (Inverter logic) トータムポール出力 (インバータロジック)	I _{FHL} = 1.6 (max)	3750	○	○	○	○	○
TLP2761 *		SO6L ・ Reinforced insulation ・ Vcc = 2.7-V/5.5-V ・ Topr (max)125°C ・ SO6L version of the TLP2361 ・ 強化絶縁対応 ・ 動作周囲温度 125°C対応 ・ TLP2361のSO6Lパッケージタイプ ・ Data Rate (Typ. @NRZ) 15 M bps				I _{FHL} = 1.6 (max)		○	○	○	○	

Note (1): Please refer to page 43. P.43 をご参照ください。

*: New product / 新製品

Data Rate: 20 M bps (Typ.) 伝送レート 20 M bps (標準)

Part Number 品番	Pin Configuration ピン接続図	Features 特長	Propagation Delay Time 伝播遅延時間 (max)		Output Form 出力形態	BVs @ 1min. 絶縁耐圧 (Vrms)	Safety Standards ⁽¹⁾ 安全規格					
			t _{pHL} (ns)	t _{pLH} (ns)			@ I _F (mA)	UL	c-UL	VDE		CQC
										EN 60747-5-5	EN 60065 EN 60950-1	
TLP116A		5 pin SO6 ・ Reinforced insulation ・ 強化絶縁対応 ・ Data Rate (Typ. @NRZ) 20 M bps			Totem-pole output (Inverter logic) トータムポール出力 (インバータロジック)			○	○	○	○	○
TLP118		5 pin SO6 ・ Reinforced insulation ・ Topr (max) 125°C ・ 強化絶縁対応 ・ 動作周囲温度 125°C 対応 ・ Data Rate (Typ. @NRZ) 20 M bps	60	60	Open-collector output (Inverter logic) オープンコレクタ出力 (インバータロジック)	I _{FHL} = 5.0 (max)	3750	○	○	○	○	○
TLP2066		5 pin MFSOP6 ・ 3.3-V power supply ・ Data Rate (Typ. @NRZ) 20 M bps			Totem-pole output (Inverter logic) トータムポール出力 (インバータロジック)			○		○		○
TLP2160		SO8 ・ Dual channel ・ 3.3-V/5-V power supplies ・ Topr (max) 125°C ・ 2 回路タイプ ・ Data Rate (Typ. @NRZ) 20 M bps	40	40	Totem-pole output (Inverter logic) トータムポール出力 (インバータロジック)	I _{FHL} = 3.5 (max)	2500	○	○	○		
TLP2168		SO8 ・ 3.3-V/5-V power supplies ・ Topr (max) 125°C ・ Data Rate (Typ. @NRZ) 20 M bps	60	60	Open-collector output (Inverter logic) オープンコレクタ出力 (インバータロジック)	I _{FHL} = 5.0 (max)		○	○	○		
TLP2366		5 pin SO6 ・ Reinforced insulation ・ 3.3-V/5-V power supplies ・ Topr (max) 125°C ・ 強化絶縁対応 ・ 動作周囲温度 125°C 対応 ・ Data Rate (Typ. @NRZ) 20 M bps	40	40	Totem-pole output (Inverter logic) トータムポール出力 (インバータロジック)	I _{FHL} = 3.5 (max)		○	○	○	○	○
TLP2368		5 pin SO6 ・ Reinforced insulation ・ Topr (max) 125°C ・ 強化絶縁対応 ・ 動作周囲温度 125°C 対応 ・ Data Rate (Typ. @NRZ) 20 M bps	60	60	Open-collector output (Inverter logic) オープンコレクタ出力 (インバータロジック)	I _{FHL} = 5.0 (max)		○	○	○	○	○
TLP2370 *		5 pin SO6 ・ Topr (max) 125°C ・ Reinforced insulation ・ Ultra low consumption ・ 強化絶縁対応 ・ 超低消費電力 ・ Data Rate (Typ. @NRZ) 20 M bps	60	60	Totem-pole output (Buffer logic) トータムポール出力 (バッファロジック)	I _{FLH} = 1.0 (max)	3750	○	○	○	○	
TLP2418		SO8 ・ Topr (max) 125°C ・ SO8 version of the TLP118 ・ 動作周囲温度 125°C 対応 ・ TLP118 の SO8 パッケージ タイプ ・ Data Rate (Typ. @NRZ) 20 M bps	75	75	Open-collector output (Inverter logic) オープンコレクタ出力 (インバータロジック)	I _{FHL} = 5.0 (max)		○	○	○		
TLP2466		SO8 ・ 3.3-V/5-V power supplies ・ Topr (max) 125°C ・ 動作周囲温度 125°C 対応 ・ Data Rate (Typ. @NRZ) 20 M bps	40	40	Totem-pole output (Inverter logic) トータムポール出力 (インバータロジック)	I _{FHL} = 3.5 (max)		○	○	○		
TLP2468		SO8 ・ 3.3-V/5-V power supplies ・ Topr (max) 125°C ・ 動作周囲温度 125°C 対応 ・ Data Rate (Typ. @NRZ) 20 M bps	60	60	Open-collector output (Inverter logic) オープンコレクタ出力 (インバータロジック)	I _{FHL} = 5.0 (max)		○	○	○		
TLP2766 TLP2766F		SDIP6 ・ 3.3-V/5-V power supplies ・ Topr (max) 125°C ・ 動作周囲温度 125°C 対応 ・ Data Rate (Typ. @NRZ) 20 M bps	40	40	Totem-pole output (Inverter logic) トータムポール出力 (インバータロジック)	I _{FHL} = 3.5 (max)	5000	○	○	○		

Note (1): Please refer to page 43. P.43 を参照ください。

*: New product / 新製品

(Data Rate: 20 M bps (Typ.) 伝送レート 20 M bps (標準))

Part Number 品番	Pin Configuration ピン接続図	Features 特長	Propagation Delay Time 伝播遅延時間 (max)		Output Form 出力形態	BV _s @ 1min. 絶縁耐圧 (Vrms)	Safety Standards ⁽¹⁾ 安全規格					
			t _{pHL} (ns)	t _{pLH} (ns)			@ I _F (mA)	UL	c-UL	VDE		CQC
					EN 60747-5-5	EN 60065 EN 60950-1						
TLP2768 TLP2768F		SDIP6 ・ 3.3-V/5-V power supplies ・ Topr (max) 125°C ・ 動作周囲温度 125°C対応 ・ Data Rate (Typ. @NRZ) 20 M bps	60	60	Open-collector output (Inverter logic) オープンコレクタ出力 (インバータロジック)	I _{FHL} = 5.0 (max)	5000	○	○	○		
TLP2768A *		SO6L ・ Reinforced insulation ・ Topr (max) 125°C ・ SO6L version of the TLP2368 ・ 強化絶縁対応 ・ 動作周囲温度 125°C対応 ・ TLP2368 の SO6L パッケージ タイプ ・ Data Rate (Typ. @NRZ) 20 M bps	60	60	Open-collector output (Inverter logic) オープンコレクタ出力 (インバータロジック)	I _{FHL} = 5.0 (max)	5000	○	○	○	○	

*: New product / 新製品

Data Rate: 50 M bps (Typ.) 伝送レート 50 M bps (標準)

Part Number 品番	Pin Configuration ピン接続図	Features 特長	Propagation Delay Time 伝播遅延時間 (max)		Output Form 出力形態	BV _s @ 1min. 絶縁耐圧 (Vrms)	Safety Standards ⁽¹⁾ 安全規格					
			t _{pHL} (ns)	t _{pLH} (ns)			@ I _F (mA)	UL	c-UL	VDE		CQC
					EN 60747-5-5	EN 60065 EN 60950-1						
TLP117		5 pin MFSOP6 ・ Ultra-high-speed ・ 超高速タイプ ・ Data Rate (Typ. @NRZ) 50 M bps	30	30	Totempole output (Inverter logic) トータムポール出力 (インバータロジック)	I _{FHL} = 5.0 (max)	3750	○	○	○		
TLP2167 **		SO8 ・ 3.3-V/5-V power supplies ・ Topr (max) 125°C ・ 動作周囲温度 125°C対応 ・ Data Rate (Typ. @NRZ) 50 M bps	**	**			2500	△	△	△		
TLP2367 **		5 pin SO6 ・ Reinforced insulation ・ 3.3-V/5-V power supplies ・ Topr (max) 125°C ・ 強化絶縁対応 ・ 動作周囲温度 125°C対応 ・ Data Rate (Typ. @NRZ) 50 M bps	**	**			3750	△	△	△		
TLP2767 **		SO6L ・ 3.3-V/5-V power supplies ・ Topr (max) 125°C ・ 動作周囲温度 125°C対応 ・ Data Rate (Typ. @NRZ) 50 M bps	**	**			5000	△	△	△		

**: Under development / 開発中



JEDEC Type JEDEC 対応

Part Number 品番	Pin Configuration ピン接続図	Features 特長	Propagation Delay Time 伝播遅延時間 (max)		CTR 変換効率	BV _s @ 1min. 絶縁耐圧 (Vrms)	Safety Standards ⁽¹⁾ 安全規格				
			t _{pHL} (μs)	t _{pLH} (μs)			min (%)	@ I _F (mA)	UL	c-UL	VDE
					EN 60747-5-5	EN 60065 EN 60950-1					
6N135		DIP8 ・ JEDEC-compliant ・ JEDEC 対応タイプ ・ Data Rate (Typ. @NRZ) 1 M bps	1.5	1.5	7	16	○	○			
6N136			0.8	0.8	19		○	○			○
6N137		DIP8 ・ JEDEC-compliant ・ High-speed ・ JEDEC 対応タイプ ・ 高速タイプ ・ Data Rate (Typ. @NRZ) 10 M bps	0.075	0.075	1000 (Typ.)	5	2500	○	○		
6N138		DIP8 ・ JEDEC-compliant ・ High-CTR ・ JEDEC 対応タイプ ・ 高変換効率タイプ ・ Data Rate (Typ. @NRZ) 300 K bps	10	35	300	1.6	○	○			
6N139			25	60	400		0.5	○	○		

Note (1): Please refer to page 43. P.43 をご参照ください。

IC Output <IGBT / MOSFET Gate Drive> IC 出力 < IGBT / MOSFET ゲート駆動用 >

Selection Table 製品選択表

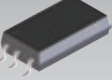
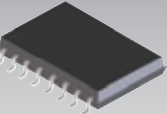
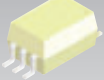
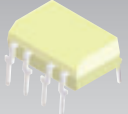
Output Peak Current (max) ピーク出力電流 (max) (A)								
	5 pin SO6	SO8	SO6L	SO16L	SDIP6 (F type)		DIP8 (F type)	
±0.3							TLP557	
±0.6	TLP151A TLP155 TLP155E	TLP2451A ■	TLP5701		TLP701 TLP701A TLP701H ■ TLP705A	TLP701F TLP701AF TLP701HF ■ TLP705AF	TLP351 TLP351A TLP351H ■	TLP351F TLP351AF TLP351HF ■
±1.0			TLP5751 * TLP5771 *				TLP5951 ** ■	
±2.0					TLP700	TLP700F		
±2.5	TLP152		TLP5702 TLP5752 * TLP5772 *		TLP700A TLP700H ■	TLP700AF TLP700HF ■	TLP250H ■ TLP350H TLP352 ■ TLP5952 ** ■	TLP250HF ■ TLP350HF TLP352F ■
±4.0			TLP5754 * TLP5774 *	TLP5214 *			TLP5954 ** ■	
±6.0							TLP358 TLP358H ■	TLP358F TLP358H ■

■: Photocouplers with a maximum operating temperature (Topr.) of 125°C / 動作周囲温度 125°C (max) 対応品
*: New product / 新製品 **: Under development / 開発中

Selection Guide 製品一覧表

IGBT/MOSFET Gate Drive IGBT/MOSFET ゲート駆動用

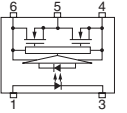
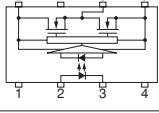
Part Number 品番	Pin Configuration ピン接続図	Features 特長	Propagation Delay Time 伝播遅延時間 (max)		Peak Output Current ピーク出力電流 (max) IOP (A)	Threshold input current スレッシュホールド入力電流 (max) IFLH (mA)	BV _s @ 1min. 絶縁耐圧 (Vrms)	Safety Standards ⁽¹⁾ 安全規格				
			t _{pHL} (μs)	t _{pLH} (μs)				VDE			CQC	
			UL	c-UL	EN 60747-5-5	EN 60065		EN 60950-1				
TLP151A		5 pin SO6 ・ Reinforced insulation ・ Topr (max) 110°C ・ Direct drive of a small-power IGBT/MOSFET ・ 強化絶縁対応 ・ 動作周囲温度 110°C 対応 ・ 小容量 IGBT の直接駆動に適合	0.45	0.45	±0.6	5	3750	○	○	○	○	
TLP152		5 pin SO6 ・ Reinforced insulation ・ Topr (max) 100°C ・ Direct drive of a medium-power IGBT/MOSFET ・ 強化絶縁対応 ・ 動作周囲温度 100°C 対応 ・ 中容量 IGBT の直接駆動に適合	0.19	0.17	±2.5	7.5		○	○	○	○	○
TLP155		5 pin SO6 ・ Reinforced insulation ・ Topr (max) 100°C ・ Direct drive of a small-power IGBT/MOSFET ・ 強化絶縁対応 ・ 動作周囲温度 100°C 対応 ・ 小容量 IGBT の直接駆動に適合	0.2	0.2	±0.6			○	○	○	○	
TLP155E						○						○
TLP250H TLP250HF		DIP8 ・ Topr (max) 125°C ・ Direct drive of a medium-power IGBT/MOSFET ・ 動作周囲温度 125°C 対応 ・ 中容量 IGBT の直接駆動に適合	0.5	0.5	±2.5	5		○	○	○	○	
TLP350H TLP350HF		DIP8 ・ Topr (max) 125°C ・ Direct drive of a medium-power IGBT/MOSFET ・ 動作周囲温度 125°C 対応 ・ 中容量 IGBT の直接駆動に適合						○	○	○		○

Note (1): Please refer to page 43. P.43 をご参照ください。

(IGBT/MOSFET Gate Drive IGBT/MOSFET ゲート駆動用)

Part Number 品番	Pin Configuration ピン接続図	Features 特長	Propagation Delay Time 伝播遅延時間 (max)		Peak Output Current ピーク出力電流 (max) I _{OP} (A)	Threshold input current スレッシュホールド入力電流 (max) I _{FLH} (mA)	BV _s @ 1 min. 絶縁耐圧 (V _{rms})	Safety Standards ⁽¹⁾ 安全規格				
			t _{pHL} (μs)	t _{pLH} (μs)				UL	c-UL	VDE		CQC
				EN 60747-5-5	EN 60065	EN 60950-1						
TLP351 TLP351F		DIP8 • Direct drive of a small-power IGBT/MOSFET • 小容量 IGBT の直接駆動に適合	0.7	0.7	±0.6		3750	○	○	○		
TLP351A TLP351AF			0.5	0.5				○	○	○	○	
TLP351H TLP351HF		DIP8 • Topr (max) 125°C • Direct drive of a small-power IGBT/MOSFET • 動作周囲温度 125°C 対応 • 小容量 IGBT の直接駆動に適合	0.7	0.7	±2.5		3750	○	○	○	○	○
TLP352 TLP352F		DIP8 • Topr (max) 125°C • Direct drive of a medium-power IGBT/MOSFET • 動作周囲温度 125°C 対応 • 中容量 IGBT の直接駆動に適合	0.2	0.2				○	○	○	○	○
TLP358 TLP358F		DIP8 • Direct drive of a medium-power IGBT/MOSFET • 中容量 IGBT の直接駆動に適合	0.5	0.5	±6.0		3750	○	○	○	○	
TLP358H TLP358HF		DIP8 • Topr (max) 125°C • Direct drive of a medium-power IGBT/MOSFET • 中容量 IGBT の直接駆動に適合						○	○	○	○	○
TLP557		DIP8 • Direct drive of a power transistor • パワートランジスタの直接駆動に適合	5	5	±0.3		2500	○	○			
TLP700 TLP700F		SDIP6 • Direct drive of a medium-power IGBT/MOSFET • SDIP6 version of the TLP350 • 中容量 IGBT の直接駆動に適合 • TLP350 の SDIP6 パッケージタイプ	0.5	0.5	±2.0	5	5000	○	○	○		
TLP700A TLP700AF		SDIP6 • Direct drive of a medium-power IGBT/MOSFET • SDIP6 version of the TLP352 • 中容量 IGBT の直接駆動に適合 • TLP352 の SDIP6 パッケージタイプ	0.2	0.2	±2.5			○	○	○		
TLP700H TLP700HF		SDIP6 • Topr (max) 125°C • Direct drive of a medium-power IGBT/MOSFET • SDIP6 version of the TLP350H • 動作周囲温度 125°C 対応 • 中容量 IGBT の直接駆動に適合 • TLP350H の SDIP6 パッケージタイプ	0.5	0.5				5000	○	○	○	
TLP701 TLP701F		SDIP6 • Direct drive of a small-power IGBT/MOSFET • SDIP6 version of the TLP351 • 小容量 IGBT の直接駆動に適合 • TLP351 の SDIP6 パッケージタイプ	0.7	0.7	±0.6		5000	○	○	○		
TLP701A TLP701AF		SDIP6 • Direct drive of a small-power IGBT/MOSFET • SDIP6 version of the TLP351A • 小容量 IGBT の直接駆動に適合 • TLP351A の SDIP6 パッケージタイプ	0.5	0.5				○	○	○		

Note (1): Please refer to page 43. P.43 をご参照ください。

(IGBT/MOSFET Gate Drive IGBT/MOSFET ゲート駆動用)















Part Number 品番	Pin Configuration ピン接続図	Features 特長	Propagation Delay Time 伝播遅延時間 (max)		Peak Output Current ピーク出力電流 (max) I _{OP} (A)	Threshold input current スレッシュホールド入力電流 (max) I _{FLH} (mA)	BV _s @ 1 min. 絶縁耐圧 (V _{rms})	Safety Standards ⁽¹⁾ 安全規格				
			t _{pHL} (μs)	t _{pLH} (μs)				UL	c-UL	VDE		CQC
										EN 60747-5-5	EN 60065 EN 60950-1	
TLP701H TLP701HF		SDIP6 <ul style="list-style-type: none"> Topr (max) 125°C Direct drive of a small-power IGBT/MOSFET SDIP6 version of the TLP351H 動作周囲温度 125°C対応 小容量 IGBT の直接駆動に適合 TLP351H の SDIP6 パッケージタイプ 	0.7	0.7		5	5000	○	○	○		
TLP705A TLP705AF		SDIP6 <ul style="list-style-type: none"> High-speed Direct drive of a small-power IGBT/MOSFET 高速タイプ 小容量 IGBT の直接駆動に適合 	0.2	0.2	±0.6	7.5		○	○	○		
TLP2451A		SO8 <ul style="list-style-type: none"> Topr (max) 125°C Direct drive of a small-power IGBT/MOSFET SO8 version of the TLP351A 動作周囲温度 125°C対応 小容量 IGBT の直接駆動に適合 TLP351A の SO8 パッケージタイプ 	0.5	0.5		5		○	○	○		
TLP5214 *		SO16L <ul style="list-style-type: none"> Topr (max) 110°C Smart gate drive photocoupler Overcurrent protection Soft shutdown Active miller clamp Direct drive of a medium-power IGBT/MOSFET Rail to Rail output スマート・ゲートドライバ付 IGBT 保護機能搭載 	0.15	0.15	±4.0	6		○	○	○	○	○
TLP5701		SO6L <ul style="list-style-type: none"> Topr (max) 110°C Direct drive of a medium-power IGBT/MOSFET SO6L version of the TLP351A 動作周囲温度 110°C対応 中容量 IGBT の直接駆動に適合 TLP351A の SO6L パッケージタイプ 	0.5	0.5	±0.6	5		○	○	○	○	○
TLP5702		SO6L <ul style="list-style-type: none"> Topr (max) 110°C Direct drive of a medium-power IGBT/MOSFET SO6L version of the TLP352 動作周囲温度 110°C対応 中容量 IGBT の直接駆動に適合 TLP352 の SO6L パッケージタイプ 	0.2	0.2	±2.5		5000	○	○	○	○	○
TLP5751 *		SO6L <ul style="list-style-type: none"> Topr (max) 110°C Direct drive of a medium-power IGBT/MOSFET Rail to Rail output 	0.15	0.15	±1.0	4		○	○	○	○	○
TLP5752 *		SO6L <ul style="list-style-type: none"> 動作周囲温度 110°C対応 中容量 IGBT の直接駆動に適合 			±2.5		○	○	○	○	○	
TLP5754 *		SO6L <ul style="list-style-type: none"> 動作周囲温度 110°C対応 中容量 IGBT の直接駆動に適合 			±4.0		○	○	○	○	○	
TLP5771 *		SO6L <ul style="list-style-type: none"> Direct drive of a medium-power IGBT/MOSFET Topr (max) 110°C Rail to Rail output 	0.15	0.15	±1.0	2		△	△	△		△
TLP5772 *		SO6L <ul style="list-style-type: none"> 中容量 IGBT の直接駆動に適合 動作周囲温度 110°C対応 			±2.5		△	△	△		△	
TLP5774 *		SO6L <ul style="list-style-type: none"> 動作周囲温度 110°C対応 			±4.0		△	△	△		△	
TLP5951 **		DIP8 <ul style="list-style-type: none"> Direct drive of a medium-power IGBT/MOSFET Topr (max) 125°C Rail to Rail output 			±1.0	4		△	△	△		△
TLP5952 **		DIP8 <ul style="list-style-type: none"> 中容量 IGBT の直接駆動に適合 動作周囲温度 125°C対応 			±2.5		△	△	△		△	
TLP5954 **		DIP8 <ul style="list-style-type: none"> 動作周囲温度 125°C対応 			±4.0		△	△	△		△	

Note (1): Please refer to page 43. P.43 をご参照ください。

*: New product / 新製品 **: Under development / 開発中

IC Output <IPM-Drive> IC 出力 <IPM 駆動用>

Selection Table 製品選択表

Data Rate 伝送レート (Typ.)	Output 出力形態							
		5 pin SO6	SO8	SO6L	SDIP6 (F type)		DIP8 (F type)	
1 Mbit/s	Open-collector オープンコレクタ	TLP104  TLP109 (IGM)	TLP2404 	TLP2704 *	TLP714 TLP719	TLP714F TLP719F	TLP559 (IGM) TLP754 TLP759 (IGM)	TLP754F TLP759F (IGM)
5 Mbit/s	Totem-pole トータムポール出力	TLP2355  TLP2358 	TLP2405 TLP2408		TLP715 TLP718	TLP715F TLP718F	TLP2955  TLP2958 	TLP2955F  TLP2958F 
10 Mbit/s	Open-collector オープンコレクタ	TLP2345 TLP2348		TLP2745 **  TLP2748 **				

: Photocouplers with a maximum operating temperature (Topr.) of 125°C / 動作周囲温度 125°C (max) 対応品

: Photocouplers with low input current. / 低入力電流品

*: New product / 新製品 **: Under development / 開発中

Selection Guide 製品一覧表

IPM Drive IPM 駆動用

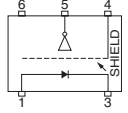
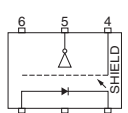
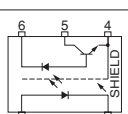
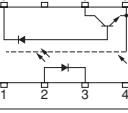
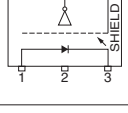
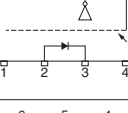
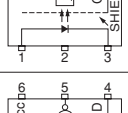
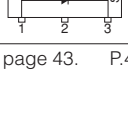
Part Number 品番	Pin Configuration ピン接続図	Features 特長	Propagation Delay Time 伝播遅延時間 (max)		CTR / Output form 変換効率 / 出力形態		BV _s @ 1min. 絶縁耐圧 (Vrms)	Safety Standards ⁽¹⁾ 安全規格				
			t _{pHL} (μs)	t _{pLH} (μs)	min	@ I _F (mA)		UL	c-UL	EN 60747-5-5	EN 60065 EN 60950-1	CQC
TLP104		5 pin SO6 ・ Reinforced insulation ・ Topr (max) 125°C ・ 強化絶縁対応 ・ 動作周囲温度 125°C 対応 ・ Data Rate (Typ. @NRZ) 1 M bps	0.4	0.55	Open-collector output (Inverter logic) オープンコレクタ出力 (インバータロジック)	I _{FHL} = 5.0 (max)	3750	○	○	○	○	○
TLP2704 *		SO6L ・ Reinforced insulation ・ Topr (max) 125°C ・ SO6L version of the TLP104 ・ 強化絶縁対応 ・ 動作周囲温度 125°C 対応 ・ TLP104 の SO6L パッケージ タイプ										
TLP109(IGM)		5 pin SO6 ・ Reinforced insulation ・ 強化絶縁対応 ・ Data Rate (Typ. @NRZ) 1 M bps	0.8	0.8	25%	10	3750	○	○	○	○	○
TLP559(IGM)		DIP8 ・ High CMR version of the TLP550 ・ TLP550 の高 CMR タイプ										
TLP714 TLP714F		SDIP6 ・ SDIP6 version of the TLP104 ・ TLP104 の SDIP6 パッケージ タイプ ・ Data Rate (Typ. @NRZ) 1 M bps	0.4	0.55	Open-collector output (Inverter logic) オープンコレクタ出力 (インバータロジック)	I _{FHL} = 5.0 (max)	5000	○	○	○	○	○
TLP754 TLP754F		DIP8 ・ DIP8 version of the TLP104 ・ TLP104 の DIP8 パッケージ タイプ ・ Data Rate (Typ. @NRZ) 1 M bps										
TLP715 TLP715F		SDIP6 ・ High CMR ・ Direct drive of an IPM	0.25	0.25	Totem-pole output (Buffer logic) トータムポール出力 (バッファロジック)	I _{FLH} = 3 (max)	○	○	○	○	○	○
TLP718 TLP718F		・ High CMR ・ IPM 直接駆動 ・ Data Rate (Typ. @NRZ) 5 M bps										

Note (1): Please refer to page 43. P.43 をご参照ください。

*: New product / 新製品

(IPM Drive IPM 駆動用)

Part Number 品番	Pin Configuration ピン接続図	Features 特長	Propagation Delay Time 伝播遅延時間 (max)		CTR / Output form 変換効率 / 出力形態		BVs @ 1min. 絶縁耐圧 (Vrms)	Safety Standards ⁽¹⁾ 安全規格				
			t_{pHL} (μ s)	t_{pLH} (μ s)	min	@ I_F (mA)		UL	c-UL	VDE		CQC
										EN 60747-5-5	EN 60065 EN 60950-1	
TLP719 TLP719F		SDIP6 • Direct drive of an IPM • 高絶縁耐圧 • Data Rate (Typ. @NRZ) 1 M bps • IPM 直接駆動	0.8	0.8	20	16	5000	○	○	○		
TLP759(IGM) TLP759F(IGM)		DIP8 • Data Rate (Typ. @NRZ) 1 M bps	0.8	0.8	25%	10	5000	○	○	○		
TLP2345		5 pin SO6 • Reinforced insulation • High-speed • Direct drive of an IPM	0.12	0.12	Totempole output (Buffer logic) トータムポール出力 (パッファロジック)		3750	○	○	○	○	○
TLP2348		• 強化絶縁対応 • 高速 • IPM 直接駆動 • Data Rate (Typ. @NRZ) 10 M bps			Totempole output (Inverter logic) トータムポール出力 (インバータロジック)							
TLP2355		5 pin SO6 • Reinforced insulation • Vcc = 3.0 ~ 20-V • Direct drive of an IPM	0.25	0.25	Totempole output (Buffer logic) トータムポール出力 (パッファロジック)		3750	○	○	○	○	○
TLP2358		• 強化絶縁対応 • IPM 直接駆動 • Data Rate (Typ. @NRZ) 5 M bps			Totempole output (Inverter logic) トータムポール出力 (インバータロジック)							
TLP2404		SO8 • Topr (max) 125°C • SO8 version of the TLP104 • 動作周囲温度 125°C 対応 • TLP104 の SO8 パッケージタイプ • Data Rate (Typ. @NRZ) 1 M bps	0.4	0.55	Open-collector output (Inverter logic) オープンコレクタ出力 (インバータロジック)		3750	○	○	○	○	○
TLP2405		SO8 • Low input current • Direct drive of an IPM	0.25	0.25	Totempole output (Buffer logic) トータムポール出力 (パッファロジック)							
TLP2408		• 低入力電流 • IPM 直接駆動 • Data Rate (Typ. @NRZ) 5 M bps			Totempole output (Inverter logic) トータムポール出力 (インバータロジック)		I_{FHL} = 1.6 (max)					
TLP2745 *		SO6L • Reinforced insulation • High-speed • Direct drive of an IPM • SO6L version of the TLP2345 • 強化絶縁対応 • 高速タイプ • TLP2345 の SO6L パッケージタイプ • Data Rate (Typ. @NRZ) 10 M bps	0.12	0.12	Totempole output (Buffer logic) トータムポール出力 (パッファロジック)		5000	○	○	○	○	○
TLP2748 *		SO6L • Reinforced insulation • High-speed • Direct drive of an IPM • SO6L version of the TLP2348 • 強化絶縁対応 • 高速タイプ • TLP2348 の SO6L パッケージタイプ • Data Rate (Typ. @NRZ) 10 M bps			Totempole output (Inverter logic) トータムポール出力 (インバータロジック)							

Note (1): Please refer to page 43. P.43 をご参照ください。

*: New product / 新製品

(IPM Drive IPM 駆動用)

Part Number 品番	Pin Configuration ピン接続図	Features 特長	Propagation Delay Time 伝播遅延時間 (max)		CTR / Output form 変換効率 / 出力形態		BVs @ 1min. 絶縁耐圧 (Vrms)	Safety Standards ⁽¹⁾ 安全規格				
			t _{pHL} (μs)	t _{pLH} (μs)	min	@ I _F (mA)		UL	c-UL	VDE		CQC
										EN 60747-5-5	EN 60065 EN 60950-1	
TLP2955 TLP2955F		DIP8 ・ Topr (max) 125°C ・ Low input current ・ Direct drive of an IPM	0.25	0.25	Totempole output (Buffer logic) トータムポール出力 (バッファロジック)	I _{FLH} = 1.6 (max)	5000	○	○	○	○	
TLP2958 TLP2958F		・ 動作周囲温度 125°C 対応 ・ 低入力電流 ・ IPM 直接駆動 ・ Data Rate (Typ. @NRZ) 5 M bps						Totempole output (Inverter logic) トータムポール出力 (インバータロジック)	I _{FHL} = 1.6 (max)	○	○	○

Transistor Output トランジスタ出力

Selection Table 製品選択表

DC Input Type DC 入カタイプ

		SO4	4pin SO6	4pin SO6L	SO16 (4channel / 4 回路)	DIP4 F type	DIP6
General-Purpose 汎用タイプ	Isolation Voltage 絶縁耐圧						
	2500 Vrms				TLP291-4		
	3750 Vrms	TLP291 (SE * ■)	TLP185 (SE * ■)				
	4000 Vrms						TLP731 TLP732
Low I _F 低入力電流タイプ	5000 Vrms			TLP385 * ●		TLP785 TLP785F	
	3750 Vrms	TLP293 * ■ ■ ■	TLP183 * ■ ■ ■ ■ TLP2301 ■ ■ ■ ■ ■ ■		TLP293-4 * ■ ■ ■		
High V _{CE0} 高コレクタ耐圧タイプ	5000 Vrms			TLP383 * ● ■ ■ ■ ■ TLP2701 * ● ■ ■ ■ ■ ■ ■			
	3750 Vrms		TLP188 * ■				
Darlington ダーリントン	5000 Vrms			TLP388 * ●			
	3750 Vrms		TLP187 ■				
High V _{CE0}	5000 Vrms			TLP387 * ●		TLP627	

*: New product / 新製品

AC Input Type AC 入カタイプ

		SO4	4pin SO6	SO16 (4channel / 4 回路)
General-Purpose 汎用タイプ	Isolation Voltage 絶縁耐圧			
	2500 Vrms			TLP290-4
Low I _F 低入力電流タイプ	3750 Vrms	TLP290(SE * ■)	TLP184(SE * ■)	TLP292-4 * ■ ■ ■ ■
	3750 Vrms	TLP292 * ■ ■ ■	TLP182 * ■ ■ ■	

- : Reinforced insulation.
(Creepage distances and Clearance 8 mm)
- : Reinforced insulation.
(Creepage distances and Clearance 5 mm)
- : Photocouplers with a maximum operating temperature of 125°C
- : Built-in RBE
- : Photocouplers with low input current.

- : 強化絶縁対応
(沿面距離、空間距離 8 mm)
- : 強化絶縁対応
(沿面距離、空間距離 5 mm)
- : 動作周囲温度 125°C (max) 対応品
- : RBE 内蔵
- : 低入力電流品

*: New product / 新製品

DC Input Type DC入力タイプ

Part Number 品番	Pin Configuration ピン接続図	Features 特長	CTR 変換効率					V _{CEO} (V)	BVs @ 1min. 絶縁耐圧 (Vrms)	Safety Standards ⁽¹⁾ 安全規格				
			Rank ランク	min (%)	max (%)	@ I _F (mA)	@ V _{CE} (V)			UL	c-UL	VDE		CQC
												EN 60747-5-5	EN 60065 EN 60950-1	
TLP183		4 pin SO6 ・ Reinforced insulation ・ Low input drive current ・ Topr = 125°C (max) ・ 強化絶縁対応 ・ 低入力電流駆動タイプ ・ 動作周囲温度 125°C対応	—	50	600	0.5	5	80	3750	○	○	○	○	○
			Y	50	150									
			YH	75	150									
			GR	100	300									
			GRL	100	200									
			GRH	150	300									
			GB	100	600									
			BL	200	600									
			BLL	200	400									
TLP185(SE)		4 pin SO6 ・ Reinforced insulation ・ General-purpose ・ 強化絶縁対応 ・ 汎用タイプ	—	50	600	5	5	80	3750	○	○	○	○	○
			Y	50	150									
			YH	75	150									
			GR	100	300									
			GRL	100	200									
			GRH	150	300									
			GB	100	600									
			BL	200	600									
			BLL	200	400									
TLP188		4 pin SO6 ・ Reinforced insulation ・ High V _{CEO} ・ 強化絶縁対応 ・ 高コレクタ耐圧	—	50	600			350		○	○	○	○	○
			GB	100										
TLP291-4		SO16 ・ 4-channel version equivalent of the TLP291 ・ Lead pitch: 1.27 mm ・ TLP291 同等の4回路タイプ ・ リードピッチ: 1.27 mm	—	50	400	5	5	80	2500	○	○	○	○	○
			GB	100										
TLP291(SE)		SO4 ・ Reinforced insulation ・ Lead pitch: 1.27 mm ・ 強化絶縁対応 ・ リードピッチ: 1.27 mm	—	50	600	5		80	3750	○	○	○	○	○
			Y	50	150									
			YH	75	150									
			GR	100	300									
			GRL	100	200									
			GRH	150	300									
			GB	100	600									
BLL	200	400												
TLP293		SO4 ・ Reinforced insulation ・ Low input drive current ・ Topr = 125°C (max) ・ 強化絶縁対応 ・ 低入力電流駆動タイプ ・ 動作周囲温度 125°C対応	—	50	600	0.5		80	3750	○	○	○	○	○
			Y	50	150									
			YH	75	150									
			GR	100	300									
			GRL	100	200									
			GRH	150	300									
			GB	100	600									
BLL	200	400												
TLP293-4		SO16 ・ Reinforced insulation ・ 4-channel version equivalent of the TLP293 ・ Lead pitch: 1.27 mm ・ Low input drive current ・ Topr = 125°C (max) ・ 強化絶縁対応 ・ TLP293 同等の4回路タイプ ・ リードピッチ: 1.27 mm ・ 低入力電流駆動タイプ ・ 動作周囲温度 125°C対応	LA	50	600	0.5	5	80	3750	○	○	○	○	○
			LGB	100										

Note (1): Please refer to page 43. P.43 をご参照ください。

(DC Input Type DCスカタイプ)

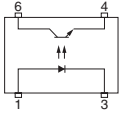
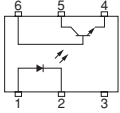
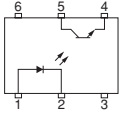
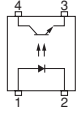
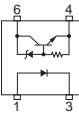
Part Number 品番	Pin Configuration ピン接続図	Features 特長	CTR 変換効率						V _{CEO} (V)	BV _s @ 1min. 絶縁耐圧 (Vrms)	Safety Standards ⁽¹⁾ 安全規格				
			Rank ランク	min (%)	max (%)	@ I _F (mA)	@ V _{CE} (V)	VDE							
								UL			c-UL	EN 60747-5-5	EN 60065 EN 60950-1	CQC	
TLP383	*	4 pin SO6L ・ Guarantees a creepage and clearance distance of 8 mm (min) ・ Low input drive current ・ Topr = 125°C (max) ・ 沿面・空間距離 8 mm (最小) 保証 ・ 低入力電流駆動タイプ ・ 動作周囲温度 125°C対応	—	50	600	0.5	5	80	5000	○	○	○	○	○	
			Y	50	150										
			YH	75	150										
			GR	100	300										
			GRL	100	200										
			GRH	150	300										
			GB	100	600										
			BL	200	600										
TLP385	*	 4 pin SO6L ・ Guarantees a creepage and clearance distance of 8 mm (min) ・ 沿面・空間距離 8 mm (最小) 保証	—	50	600	5	5	80	5000	○	○	○	○	○	
			Y	50	150										
			YH	75	150										
			GR	100	300										
			GRL	100	200										
			GRH	150	300										
			GB	100	600										
			BL	200	600										
BLL	200	400													
TLP388	*	4 Pin SO6L ・ Guarantees a creepage and clearance distance of 8 mm (min) ・ High V _{CEO} : 350 V (max) ・ 沿面・空間距離 8 mm (最小) ・ 高コレクタ耐圧: 350 V (max)	—	50	600	5	5	350	5000	△	△	△			
			GB	100											
TLP731		DIP6 ・ Internal base connection ・ ベース接続あり	—	50	600	5	5	55	4000	○	○	○			
			GR	100	300										
			GB	100	600										
TLP732		DIP6 ・ No internal base connection ・ ベース接続なし	—	50	600	5	5	55	4000	○	○	○			
			GR	100	300										
			GB	100	600										
TLP785 TLP785F	⁽³⁾ ⁽³⁾ 	DIP4 ・ High isolation voltage ・ 高絶縁耐圧	—	50	600	5	5	80	5000	○	○	○		○	
			Y	50	150										
			YH	75	150										
			GR	100	300										
			GRL	100	200										
			GRH	150	300										
			GB	100	600										
			BL	200	600										
BLL	200	400													
TLP2301	*	4 pin SO6 ・ Reinforced insulation ・ Low input drive current ・ Built-in R _{BE} ・ Topr = 125°C (max) ・ Equivalent to the TLP2301 with the IC output. ・ 強化絶縁対応 ・ 低入力電流駆動タイプ ・ R _{BE} 内蔵 ・ 動作周囲温度 125°C対応 ・ IC 出力タイプの TLP2301 と同一製品	—	50	600	1	5	40	3750	○	○	○	○	○	
			GB	100	600										
TLP2701	*	 4 Pin SO6L ・ Guarantees a creepage and clearance distance of 8mm (min) ・ Low input drive current ・ Built-in R _{BE} ・ Topr = 125°C (max) ・ Equivalent to the TLP2701 with the IC output ・ 沿面・空間距離 8 mm (最小) ・ 低入力電流駆動タイプ ・ R _{BE} 内蔵 ・ 動作周囲温度 125°C対応 ・ IC 出力タイプの TLP2701 と同一製品	—	50	600	1	5	40	5000	△	△	△			
			GB	100											

Note (1)(3): Please refer to page 43. P.43 をご参照ください。

*: New product / 新製品

AC Input Type AC入力タイプ

Part Number 品番	Pin Configuration ピン接続図	Features 特長	CTR 変換効率					V _{CEO} (V)	BV _s @ 1min. 絶縁耐圧 (Vrms)	Safety Standards ⁽¹⁾ 安全規格					
			Rank ランク	min (%)	max (%)	@ I _F (mA)	@ V _{CE} (V)			UL	c-UL	VDE			CQC
												EN 60747-5-5	EN 60065 EN 60950-1	CQC	
TLP182		4 pin SO6 ・ Reinforced insulation ・ Low input drive current ・ Topr = 125°C (max) ・ 強化絶縁対応 ・ 低入力電流駆動タイプ ・ 動作周囲温度 125°C対応	—	50	600	±0.5	5	80	3750	○	○	○	○	○	
			Y	50	150										
			GR	100	300										
			GB	100	600										
			BL	200	600										
TLP184(SE)		4 pin SO6 ・ Reinforced insulation ・ 強化絶縁対応	—	50	600	±5	5	80	2500	○	○	○	○	○	
			Y	50	150										
			GR	100	300										
			GB	100	600										
			BL	200	600										
TLP290-4		SO16 ・ 4-channel version equivalent of the TLP290 ・ Lead pitch: 1.27 mm ・ TLP290 同等の4回路タイプ ・ リードピッチ: 1.27 mm	—	50	400	±5	5	80	2500	○	○	○	○	○	
			GB	100	400										
TLP290(SE)		SO4 ・ Reinforced insulation ・ Lead pitch: 1.27 mm ・ 強化絶縁対応 ・ リードピッチ: 1.27 mm	—	50	600	±5	5	80	3750	○	○	○	○	○	
			Y	50	150										
			GR	100	300										
			GB	100	600										
			BL	200	600										
TLP292		SO4 ・ Reinforced insulation ・ Low input drive current ・ Topr = 125°C (max) ・ 強化絶縁対応 ・ 低入力電流駆動タイプ ・ 動作周囲温度 125°C対応	—	50	600	±0.5	5	80	3750	○	○	○	○	○	
			Y	50	150										
			GR	100	300										
			GB	100	600										
			BL	200	600										
TLP292-4 *		SO16 ・ Reinforced insulation ・ 4-channel version equivalent of the TLP292 ・ Low input drive current ・ Lead pitch: 1.27 mm ・ Topr = 125°C (max) ・ 強化絶縁対応 ・ TLP292 同等の4回路タイプ ・ 低入力電流駆動タイプ ・ リードピッチ: 1.27 mm ・ 動作周囲温度 125°C対応	LA	50	600	±0.5	5	80	3750	○	○	○	○	○	
			LGB	100											

*: New product / 新製品

Darlington Transistor Output Type ダーリントントランジスタ出力タイプ



Part Number 品番	Pin Configuration ピン接続図	Features 特長	CTR 変換効率			V _{CE} (sat)			V _{CEO} (V)	BV _s @ 1min 絶縁耐圧 (Vrms)	Safety Standards ⁽¹⁾ 安全規格					
			min (%)	@ I _F (mA)	@ V _{CE} (V)	max (V)	@ I _c (mA)	@ I _F (mA)			UL	c-UL	VDE			CQC
													EN 60747-5-5	EN 60065 EN 60950-1	CQC	
TLP187		4 pin SO6 ・ Reinforced insulation ・ High V _{CEO} ・ 強化絶縁対応 ・ 高コレクタ耐圧	1000	1	1	1.2	100	10	300	3750	○	○	○	○	○	
TLP387 *		4 Pin SO6L ・ Reinforced insulation ・ High V _{CEO} ・ 強化絶縁対応 ・ 高コレクタ耐圧	1000	1	1	1.2	100	10	300	5000	△	△	△			
TLP627		DIP4 ・ High V _{CEO} ・ 高コレクタ耐圧	1000	1	1	1.2	100	10	300	5000	○	○	○			

Note (1): Please refer to page 43. P.43 をご参照ください。

*: New product / 新製品

Triac Output トライアック出力

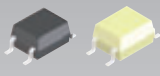
Selection Table 製品選択表

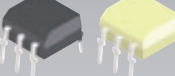
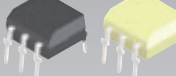
											
VDRM	Isolation Voltage 絶縁耐圧	NZC / ZC	4 pin SO6	4 pin MFSOP6 (No5 cut)	DIP4		5 pin DIP6		5 pin DIP6 (cut)		
						F type		F type		F type	
400 V	2500 Vrms	NZC			TLP525G				TLP560G		
		ZC							TLP561G		
	5000 Vrms	NZC							TLP3022(S) TLP3023(S) TLP665G(S)	TLP3022F(S) TLP3023F(S) TLP665GF(S)	
		ZC							TLP3042(S) TLP3043(S) TLP666G(S)	TLP3042F(S) TLP3043F(S) TLP666GF(S)	
600 V	2500 Vrms	NZC								TLP560J	
		ZC		TLP163J						TLP561J	
	3750 Vrms	NZC	TLP265J * ■ TLP267J * ■								
		ZC	TLP266J * ■ TLP268J * ■								
	4000 Vrms	NZC						TLP762J	TLP762JF		
		ZC						TLP763J	TLP763JF		
5000 Vrms	NZC				TLP360J	TLP360JF	TLP3052A *		TLP665J(S)	TLP665JF(S)	
	ZC				TLP361J TLP363J	TLP361JF TLP363JF	TLP3062A *		TLP3062(S) TLP3063(S) TLP3064(S) TLP663J(S) TLP666J(S) TLP668J(S)	TLP3062F(S) TLP3063F(S) TLP3064F(S) TLP663JF(S) TLP666JF(S) TLP668JF(S)	
800 V	5000 Vrms	NZC							TLP3073 *	TLP665L	
		ZC						TLP3782(S) TLP3783(S) TLP3083 *	TLP3782F(S) TLP3783F(S)	TLP669L(S) TLP3082(S) TLP666L(S)	TLP669LF(S) TLP3082F(S) TLP666LF(S)

■: Reinforced Insulation / 強化絶縁対応
*: New product / 新製品

Selection Guide 製品一覧表

V_{DRM} = 400 V

Part Number 品番	Pin Configuration ピン接続図	Features 特長	Trigger LED Current トリガLED電流 I _{FT}		Peak On-state Voltage せん頭順電圧降下 V _{TM}		Off-state Output Terminal Voltage せん頭順阻止電圧 V _{DRM} (V)	BV _s @ 1 min. 絶縁耐圧 (Vrms)	Safety Standards ⁽¹⁾ 安全規格				
			Rank ランク	max (mA)	max (V)	@ I _{TM} (mA)			UL	c-UL	VDE		CQC
							EN 60747-5-5	EN 60065 EN 60950-1					
TLP525G		DIP4 ・ Non-zero cross ・ 非ゼロクロス	—	10	3.0	100	400	2500	○	○			
TLP560G		5 pin DIP6 (cut) ・ General-purpose ・ Non-zero cross ・ 汎用タイプ ・ 非ゼロクロス	—	10	3.0	100	400	2500	○	○	○		
			IFT7	7									
TLP561G		5 pin DIP6 (cut) ・ General-purpose ・ Zero cross ・ 汎用タイプ ・ ゼロクロス	—	10	3.0	100	400	2500	○	○	○		
			IFT7	7									
TLP3022(S) TLP3022F(S)		5 pin DIP6 (cut) ・ Non-zero cross ・ 非ゼロクロス	—	10	3.0	100	400	5000	○	○	○	○	
			IFT5	5									
TLP3023(S) TLP3023F(S)		5 pin DIP6 (cut) ・ Non-zero cross ・ 非ゼロクロス	—	5	3.0	100	400	5000	○	○	○	○	
			IFT5	5									
TLP3042(S) TLP3042F(S)		5 pin DIP6 (cut) ・ Zero cross ・ ゼロクロス	—	10	3.0	100	400	5000	○	○	○	○	
			IFT5	5									
TLP3043(S) TLP3043F(S)		5 pin DIP6 (cut) ・ Zero cross ・ ゼロクロス	—	5	3.0	100	400	5000	○	○	○	○	

V_{DRM} = 600 V

Part Number 品番	Pin Configuration ピン接続図	Features 特長	Trigger LED Current トリガLED電流 I _{FT}		Peak On-state Voltage せん頭順電圧降下 V _{TM}		Off-state Output Terminal Voltage せん頭順阻止電圧 V _{DRM} (V)	BV _s @ 1 min. 絶縁耐圧 (Vrms)	Safety Standards ⁽¹⁾ 安全規格				
			Rank ランク	max (mA)	max (V)	@ I _{TM} (mA)			UL	c-UL	VDE		CQC
							EN 60747-5-5	EN 60065 EN 60950-1					
TLP163J		4 pin MFSOP6 (cut) ・ Zero cross ・ High impulse noise immunity ・ V _N = 2000 V (typ.) ・ ゼロクロス ・ インパルスノイズ耐量 ・ V _N = 2000 V (typ.)	—	10	2.8	70	600	2500	○	○			
TLP265J		4 pin SO6 ・ Reinforced insulation ・ Non-zero cross ・ 強化絶縁対応 ・ 非ゼロクロス	—	10	2.8	70	600	3750	○	○	○	○	○
			IFT7	7									
TLP266J		4 pin SO6 ・ Reinforced insulation ・ Zero cross ・ 強化絶縁対応 ・ ゼロクロス	—	10	2.8	70	600	3750	○	○	○	○	○
			IFT7	7									
TLP267J		4 pin SO6 ・ Reinforced insulation ・ Non-zero cross ・ Low trigger LED current ・ 強化絶縁対応 ・ 非ゼロクロス ・ 低トリガLED電流	—	3	2.8	70	600	3750	○	○	○	○	○
			IFT2	2									

Note (1): Please refer to page 43. P.43 をご参照ください。

(V_{DRM} = 600 V)

Part Number 品番	Pin Configuration ピン接続図	Features 特長	Trigger LED Current トリガ LED 電流 I _{FT}		Peak On-state Voltage せん頭順電圧降下 V _{TM}		Off-state Output Terminal Voltage せん頭順阻止電圧 V _{DRM} (V)	BVs @ 1min. 絶縁耐圧 (Vrms)	Safety Standards ⁽¹⁾ 安全規格				
			Rank ランク	max (mA)	max (V)	@ I _{TM} (mA)			UL	c-UL	VDE		CQC
							EN 60747-5-5	EN 60065 EN 60950-1					
TLP268J		4 pin SO6 ・ Reinforced insulation ・ Zero cross ・ Low trigger LED current ・ 強化絶縁対応 ・ ゼロクロス ・ 低トリガ LED 電流	—	3	2.8	70	600	3750	○	○	○	○	○
			IFT2	2									
TLP360J TLP360JF		DIP4 ・ Non-zero cross ・ 非ゼロクロス	—	10	3.0	100	600	5000	○	○	○	○	○
			IFT7	7									
TLP361J TLP361JF		DIP4 ・ Zero cross ・ ゼロクロス	—	10	3.0	100	600	5000	○	○	○	○	○
			IFT7	7									
TLP363J TLP363JF		DIP4 ・ Zero cross ・ High impulse noise immunity ・ V _N = 2000 V (typ.) ・ ゼロクロス ・ インパルスノイズ耐量 ・ V _N = 2000 V (typ.)	—	10	3.0	100	600	5000	○	○	○	○	○
			IFT7	7									
TLP560J		5 pin DIP6 (cut) ・ General-purpose ・ Non-zero cross ・ 汎用タイプ ・ 非ゼロクロス	—	10	3.0	100	600	2500	○	○	○	○	○
			IFT7	7									
TLP561J		5 pin DIP6 (cut) ・ General-purpose ・ Zero cross ・ 汎用タイプ ・ ゼロクロス	—	10	3.0	100	600	2500	○	○	○	○	○
			IFT7	7									
TLP762J TLP762JF		5 pin DIP6 ・ Non-zero cross ・ 非ゼロクロス	—	10	3.0	100	600	4000	○	○	○	○	○
			IFT7	7									
TLP763J TLP763JF		5 pin DIP6 ・ Zero cross ・ ゼロクロス	—	10	3.0	100	600	4000	○	○	○	○	○
			IFT7	7									
TLP3052A *		5 pin DIP6 ・ Non-zero cross ・ 非ゼロクロス	—	10	3.0	100	600	5000	○	○	○	○	○
TLP3062(S) TLP3062F(S)		5 pin DIP6 (cut) ・ High V _{DRM} ・ Zero cross ・ 高せん頭順阻止電圧 ・ ゼロクロス	—	10									
TLP3062A *		5 pin DIP6 ・ Zero cross ・ ゼロクロス	—	10									
TLP3063(S) TLP3063F(S)		5 pin DIP6 (cut) ・ High V _{DRM} ・ Zero cross ・ 高せん頭順阻止電圧 ・ ゼロクロス	—	5									
TLP3064(S) TLP3064F(S)		5 pin DIP6 (cut) ・ Zero cross ・ ゼロクロス	—	3									

Note (1): Please refer to page 43. P.43 をご参照ください。

*: New product / 新製品

V_{DRM} = 800 V

Part Number 品番	Pin Configuration ピン接続図	Features 特長	Trigger LED Current トリガ LED 電流 I _{FT}		Peak On-state Voltage せん頭順電圧降下 V _{TM}		Off-state Output Terminal Voltage せん頭順阻止電圧 V _{DRM} (V)	BV _s @ 1 min. 絶縁耐圧 (Vrms)	Safety Standards ⁽¹⁾ 安全規格				
			Rank ランク	max (mA)	max (V)	@ I _{TM} (mA)			UL	c-UL	VDE		CQC
							EN 60747-5-5	EN 60065 EN 60950-1					
TLP3073 *		5 pin DIP6 ・ Non-zero cross ・ 非ゼロクロス	—	5					○	○	○	○	○
TLP3082(S) TLP3082F(S)		5 pin DIP6 (cut) ・ Zero cross ・ ゼロクロス	—	10					○	○	○	○	
TLP3083 *		5 pin DIP6 ・ Zero cross ・ ゼロクロス	—	5	3.0	100	800	5000	○	○	○	○	○
TLP3782(S) TLP3782F(S)		5 pin DIP6 ・ Zero cross ・ High impulse noise immunity ・ V _N = 1500 V (typ.)	—	10					○	○	○	○	
TLP3783(S) TLP3783F(S)		・ ゼロクロス ・ インパルスノイズ耐量 ・ V _N = 1500 V (typ.)	—	5					○	○	○	○	

*: New product / 新製品



Product for Japan 日本国内向け製品

Part Number 品番	Pin Configuration ピン接続図	Features 特長	Trigger LED Current トリガ LED 電流 I _{FT}		Peak On-state Voltage せん頭順電圧降下 V _{TM}		Off-state Output Terminal Voltage せん頭順阻止電圧 V _{DRM} (V)	BV _s @ 1 min. 絶縁耐圧 (Vrms)	Safety Standards ⁽¹⁾ 安全規格				
			Rank ランク	max (mA)	max (V)	@ I _{TM} (mA)			UL	c-UL	VDE		CQC
							EN 60747-5-5	EN 60065 EN 60950-1					
TLP663J(S) TLP663JF(S)		5 pin DIP6 (cut) ・ Zero cross ・ High impulse noise immunity ・ V _N = 2000 V (typ.) ・ ゼロクロス ・ インパルスノイズ耐量 ・ V _N = 2000 V (typ.)	—	10	3.0	100	600	5000	○	○	○	○	
TLP665G(S) TLP665GF(S)		5 pin DIP6 (cut) ・ Non-zero cross ・ 非ゼロクロス	—	10			400		○	○	○	○	
TLP665J(S) TLP665JF(S)		5 pin DIP6 (cut) ・ High V _{DRM} ・ Non-zero cross ・ 高せん頭順阻止電圧 ・ 非ゼロクロス	—	10	3.0	100	600	5000	○	○	○	○	○
TLP665L ⁽⁴⁾		5 pin DIP6 (cut) ・ Non-zero cross ・ 非ゼロクロス	—	10			800		○	○	○	○	○
TLP666G(S) TLP666GF(S)		5 pin DIP6 (cut) ・ Zero cross ・ ゼロクロス	—	10			400		○	○	○	○	
TLP666J(S) TLP666JF(S)		5 pin DIP6 (cut) ・ High V _{DRM} ・ Zero cross ・ 高せん頭順阻止電圧 ・ ゼロクロス	—	10			600		○	○	○	○	
TLP666L(S) TLP666LF(S)		5 pin DIP6 (cut) ・ Zero cross ・ ゼロクロス	—	10	3.0	100	800	5000	○	○	○	○	○
TLP668J(S) TLP668JF(S)		5 pin DIP6 (cut) ・ Zero cross ・ ゼロクロス	—	3			600		○	○	○	○	
TLP669L(S) TLP669LF(S)		5 pin DIP6 (cut) ・ Zero cross ・ High impulse noise immunity ・ V _N = 1500 V (typ.) ・ ゼロクロス ・ インパルスノイズ耐量 ・ V _N = 1500 V (typ.)	—	10			800		○	○	○	○	
			IFT5	5									

Note (1)(4): Please refer to page 43. P.43 をご参照ください。

Thyristor Output サイリスタ出力

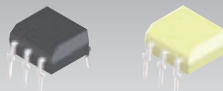
Selection Table 製品選択表

					
V _{DRM}	Isolation Voltage 絶縁耐圧	5 pin MFSOP6	DIP6		7 pin DIP8
				F type	
400 V	2500 Vrms	TLP148G			
600 V	2500 Vrms		TLP548J		TLP549J
	4000 Vrms		TLP748J	TLP748JF	



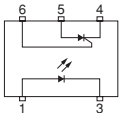
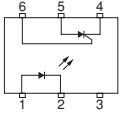
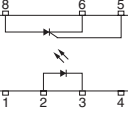
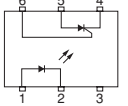



Selection Guide 製品一覧表

Part Number 品番	Pin Configuration ピン接続図	Features 特長	Trigger LED Current トリガ LED 電流 I _{FT} max (mA)	Peak On-state Voltage せん頭順電圧降下 V _{TM}		Off-state Output Terminal Voltage せん頭順阻止電圧 V _{DRM} (V)	BVs @ 1 min. 絶縁耐圧 (Vrms)	Safety Standards ⁽¹⁾ 安全規格				
				max (V)	@ I _{TM} (mA)			UL	c-UL	VDE		CQC
										EN 60747-5-5	EN 60065 EN 60950-1	
TLP148G		5 pin MFSOP6 ・ General-purpose ・ 汎用タイプ	10	1.45	100	400	2500	○	○			
TLP548J		DIP6 ・ General-Purpose ・ Low trigger current ・ 汎用タイプ ・ 低トリガ電流	7	1.45	100	600	2500	○	△			
TLP549J		7 pin DIP8 ・ Long anode-cathode distance (SCR) ・ SCR アノード-カソード間、長スペースタイプ	7	1.45	100	600	2500	○	△			
TLP748J TLP748JF		DIP6	10	1.45	100	600	4000	○	○	○		

Note (1): Please refer to page 43. P.43 をご参照ください。











Photovoltaic Output フォトボル出力

Selection Table 製品選択表

						
Open Voltage 開放電圧 (Min)	Isolation Voltage 絶縁耐圧	Short-Circuit current 短絡電流 (Min)	SSOP4	4 pin SO6	4 pin MFSOP6	5 pin DIP6 (cut)
7 V	1500 Vrms	5 μ A	TLP3904			
		20 μ A	TLP3914			
	2500 Vrms	5 μ A			TLP3902	
		12 μ A			TLP190B	TLP590B
		24 μ A			TLP191B	TLP591B
	3750 Vrms	12 μ A		TLP3905  TLP3906 		
30 V	1500 Vrms	4 μ A	TLP3924			

: Photocouplers with a maximum operating temperature (Topr.) of 125°C / 動作周囲温度 125°C (max) 対応品

Selection Guide 製品一覧表











Part Number 品番	Pin Configuration ピン接続図	Features 特長	Short-Circuit Current 短絡電流 Isc			Open Voltage 開放電圧 Voc		BVs @ 1min. 絶縁耐圧 (Vrms)	Safety Standards ⁽¹⁾ 安全規格				
			Rank ランク	min (μ A)	@ If (mA)	min (V)	@ If (mA)		UL	c-UL	VDE		CQC
											EN 60747-5-5	EN 60065 EN 60950-1	
TLP190B		4 pin MFSOP6	— C20	12 20	10	7	10	2500	○	○			
TLP191B		4 pin MFSOP6 ・ Built-in shunt resistor ・ シャント抵抗内蔵	—	24	20		20		○	○			
TLP590B		5 pin DIP6 (cut) ・ General-purpose ・ 汎用タイプ	— C20	12 20	10	7	10	2500	○				
TLP591B		5 pin DIP6 (cut) ・ Built-in shunt resistor ・ シャント抵抗内蔵	—	24	20		20		○				
TLP3902		4 pin MFSOP6 ・ General-purpose ・ 汎用タイプ	—	5	10	7	10	2500	○	○			
TLP3904		SSOP4 ・ General-purpose ・ 汎用タイプ	—	5	10	7	10	1500	○				
TLP3905		4 pin SO6 ・ General-purpose ・ Topr = 125°C (max) ・ 汎用タイプ ・ 動作周囲温度 125°C 対応	— C20	12 20	10	7	10	3750	○	○	○	○	
TLP3906		4 pin SO6 ・ Built-in discharging circuit ・ Topr = 125°C (max) ・ 放電制御回路内蔵 ・ 動作周囲温度 125°C 対応	— C20	12 20					○	○	○	○	
TLP3914		SSOP4 ・ High output ・ 高出カタイプ	—	20	10	7	10	1500	○				
TLP3924		SSOP4 ・ High open-circuit voltage ・ 高開放電圧タイプ	—	4	10	30	10	1500	○				

Note (1): Please refer to page 43. P.43 をご参照ください。

Photorelays フォトリレー











Selection Table 製品選択表

1-Form-A / 1a 接点シリーズ

													
V _{OFF} 阻止電圧 (max)V	R _{ON} オン抵抗 (max)Ω	I _{ON} オン電流 (max)A	VSON4	USOP4	SSOP4	4 pin SO6	2.54SOP4	2.54SOP6	2.54SOP8	DIP4 F type	DIP6 F type	DIP8	
20	8	±0.16		TLP3330	TLP3230		TLP3130						
	5	±0.2	TLP3450 *	TLP3350	TLP3250								
	1.2	±0.3					TLP3131						
	1.2	±0.45	TLP3431 **		TLP3231								
	0.22	±0.9		TLP3303	TLP3203								
	0.22	±1	TLP3403 *										
	0.08	±3.0							TLP3553				
	0.05	±2.5						TLP3100				TLP3543	
30	0.04	±4.0						TLP3106 *					
40	20	±0.1	TLP3442 *	TLP3342									
	15	±0.12			TLP3216		TLP3116						
	14	±0.12	TLP3440 *	TLP3340	TLP3240								
	10	±0.14	TLP3441 *	TLP3341	TLP3241								
	5	±0.2											
	3	±0.25			TLP3214		TLP3114						
	1.5	±0.3		TLP3315	TLP3215		TLP3115						
	0.2	±2.0							TLP241A * ■	TLP241AF * ■			
	0.15	±2.0											
	0.15	±2.5								TLP3554			
50	0.13	±1.0					TLP3123						
	0.06	±2.5						TLP3102					
	0.06	±3.5									TLP3544		
	1.5	±0.3	TLP3475 *	TLP3375	TLP3275								
	60	50	±0.1				TLP175A						
		15	±0.12	TLP3451 *	TLP3351								
		2	±0.4					TLP170A TLP171A TLP172A TLP176A	TLP192A TLP197A	TLP202A TLP206A			
		2	±0.5								TLP222A TLP227A TLP240A * ■	TLP240AF * ■	TLP592A TLP597A TLP598AA
		1.5	±0.4	TLP3412 *	TLP3312	TLP3212							
		1.1	0.5								TLP225A		
0.7		±1.0					TLP3122						
0.2		±2.0								TLP3555			
0.13		±1.7						TLP3127 *					
0.1		±2.5										TLP3542	
75	0.07	±2.3										TLP3545	
	0.07	±3.0						TLP3103					
	0.06	±3.3						TLP3107					
	0.05	±5.0										TLP3547 **	
	2	±0.4		TLP3306									
	80	25	±0.04					TLP3118					
		20	±0.1										
		12	±0.12	TLP3417 *	TLP3317	TLP3217							
8		±0.2	TLP3419 *	TLP3319			TLP3119						
1.2		±0.35											

■: Reinforced Insulation / 強化絶縁対応
*: New product / 新製品 **: Under development / 開発中

1-Form-A (Continued) / 1a 接点シリーズ (続き)



														
V _{OFF} 阻止電圧 (max)V	R _{ON} オン抵抗 (max)Ω	I _{ON} オン電流 (max)A	VSON4	USOP4	SSOP4	4 pin SO6	2.54SOP4	2.54SOP6	2.54SOP8	DIP4 F type		DIP6 F type		DIP8
80	0.15	±1.25						TLP3120						
100	14	±0.08			TLP3220									
	14	±0.1	TLP3420 *	TLP3320							TLP3556			
	0.7	±1.0												
	0.2	±1.4						TLP3105						
	0.2	±2.0										TLP3546		
	0.07	±2.0						TLP3109 *						
200	8	±0.2					TLP170D TLP171D TLP176D	TLP197D	TLP200D					
	8	±0.25								TLP240D * ■	TLP240DF * ■			
	8	±0.3								TLP222D				
350	50	±0.1					TLP170G			TLP240G * ■	TLP240GF * ■			
	50	±0.11					TLP172G	TLP192G	TLP202G					
	50	±0.12								TLP222G TLP228G		TLP592G		
	35	±0.12					TLP174G TLP176G	TLP197G	TLP206G	TLP224G TLP227G		TLP597G		
400	35	±0.1					TLP171GA							
	35	±0.12					TLP174GA TLP176GA	TLP197GA	TLP206GA	TLP224GA TLP227GA TLP240GA * ■	TLP240GAF * ■	TLP597GA TLP797GA	TLP797GAF	
	12	±0.15										TLP598GA TLP798GA		
	5	±0.4												TLP3548 **
	4	±0.2							TLP3125					
600	60	±0.07					TLP171J							
	60	±0.09					TLP170J			TLP240J * ■	TLP240JF * ■			
	45	±0.1										TLP797J	TLP797JF	
	2	±0.6												TLP3549 **

■: Reinforced Insulation / 強化絶縁対応
*: New product / 新製品 **: Under development / 開発中

2-Form-A / 2a 接点シリーズ

			
V _{OFF} 阻止電圧 (max)V	R _{ON} オン抵抗 (max)Ω	I _{ON} オン電流 (max)A	DIP8
60	2	±0.5	TLP222A-2 TLP227A-2
350	50	±0.12	TLP222G-2 TLP228G-2
	35	±0.12	TLP224G-2 TLP227G-2
400	35	±0.12	TLP224GA-2 TLP227GA-2

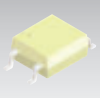
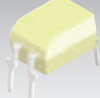
1-Form-B / 1b 接点シリーズ

					
V _{OFF} 阻止電圧 (max)V	R _{ON} オン抵抗 (max)Ω	I _{ON} オン電流 (max)A	2.54SOP4	DIP4	DIP6
350	25	±0.12	TLP4176G TLP4197G		
		±0.15		TLP4227G	TLP4597G

2-Form-B / 2b 接点シリーズ

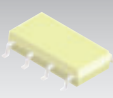
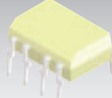
				
V _{OFF} 阻止電圧 (max)V	R _{ON} オン抵抗 (max)Ω	I _{ON} オン電流 (max)A	2.54SOP8	DIP8
350	25	±0.12	TLP4206G	
		±0.15		TLP4227G-2

1-Form-A, 1-Form-B / 1a, 1b 接点シリーズ

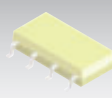
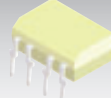
				
V _{OFF} 阻止電圧 (max)V	R _{ON} オン抵抗 (max)Ω	I _{ON} オン電流 (max)A	2.54SOP8	DIP8
350	25	±0.12	TLP4006G	TLP4026G

Selection Guide 製品一覧表

1-Form-A: VSON4 package 1a 接点シリーズ: VSON4 パッケージ

Part Number 品番	Pin Configuration ピン接続図	Features 特長	Trigger LED Current トリガ LED 電流 I _{FT} max (mA)	On-state Resistance オン抵抗 R _{ON}		On-state Current オン電流 I _{ON} max (A)	Off-state Voltage オフ電圧 V _{OFF} (V)	BV _s @ 1 min. 絶縁耐圧 (Vrms)	Safety Standards ⁽¹⁾ 安全規格				
				max (Ω)	@ I _F (mA)				UL	c-UL	VDE		CQC
											EN 60747-5-5	EN 60065 EN 60950-1	
TLP3403 *		VSON4 • Low R _{ON} • High I _{ON}	3	0.22	5	±1	20	300					
TLP3412 *		VSON4 • Low R _{ON} • 60-V V _{OFF}		1.5		±0.4	60						
TLP3417 *		VSON4 • Low CR • COFF: 5 pF (Typ.)		12		±0.12	80						
TLP3419 *		VSON4 • COFF: 6.5 pF (Typ.)		8		±0.2							
TLP3420 *		VSON4 • 100-V V _{OFF}		14		10	±0.1		100				
TLP3431 *		VSON4 • Low R _{ON}		1.2		±0.45	20						
TLP3440 *		VSON4 • Ultra-low CR: 5 pF · Ω • COFF: 0.45 pF (Typ.) • 超低 CR: 5 pF · Ω		14		±0.12	40						
TLP3441 *		VSON4		10		±0.14							
TLP3442 *		VSON4 • COFF: 0.3 pF (Typ.)		20		5	±0.1						
TLP3450 *		VSON4 • Ultra-low CR: 2.5 pF · Ω		5		±0.2	20						
TLP3451 *		VSON4		15		±0.12	60						
TLP3475 *		VSON4 • COFF: 12 pF (Typ.)		1.5		±0.3	50						

*: New product / 新製品

1-Form-A: USOP4 package 1a 接点シリーズ: USOP4 パッケージ

Part Number 品番	Pin Configuration ピン接続図	Features 特長	Trigger LED Current トリガ LED 電流 I _{FT} max (mA)	On-state Resistance オン抵抗 R _{ON}		On-state Current オン電流 I _{ON} max (A)	Off-state Voltage オフ電圧 V _{OFF} (V)	BV _s @ 1 min. 絶縁耐圧 (Vrms)	Safety Standards ⁽¹⁾ 安全規格				
				max (Ω)	@ I _F (mA)				UL	c-UL	VDE		CQC
											EN 60747-5-5	EN 60065 EN 60950-1	
TLP3303		USOP4 • Ultra-low On-resistance R: 0.18Ω (Typ.) • High output current I _{ON} : 0.9 A (max) • 超低オン抵抗 • 高出力電流	3	0.22	5	±0.9	20	500	○				
TLP3306		USOP4 • 75-V V _{OFF}		2		±0.4	75		○				
TLP3312		USOP4 • Low R _{ON} • 60-V V _{OFF}		1.5		±0.4	60		○				

Note (1): Please refer to page 43. P.43 をご参照ください。

(1-Form-A: USOP4 package 1a 接点シリーズ: USOP4 パッケージ)

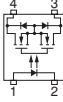
Part Number 品番	Pin Configuration ピン接続図	Features 特長	Trigger LED Current トリガ LED 電流 I _{FT} max (mA)	On-state Resistance オン抵抗 R _{ON}		On-state Current オン電流 I _{ON} max (A)	Off-state Voltage オフ電圧 V _{OFF} (V)	BV _s @ 1 min. 絶縁耐圧 (V _{rms})	Safety Standards ⁽¹⁾ 安全規格				
				max (Ω)	@ I _F (mA)				UL	c-UL	VDE		CQC
											EN 60747-5-5	EN 60065 EN 60950-1	
TLP3315		USOP4 • Ultra-low CR: 10 pF·Ω • R _{ON} : 1Ω (Typ.) • 超低 CR: 10 pF·Ω		1.5		±0.3	40	500	○				
TLP3317		USOP4 • Low CR • C _{OFF} : 5 pF (Typ.) • 低 CR: 35 pF·Ω		12	5	±0.12	80		○				
TLP3319		USOP4 • C _{OFF} : 6.5 pF (Typ.) • 低 CR: 6.5 pF·Ω		8		±0.2			○				
TLP3320		USOP4 • 100-V V _{OFF}		14	10	±0.1	100		○				
TLP3330		USOP4 • Ultra-low CR: 5 pF·Ω • C _{OFF} : 1 pF (Typ.) • 超低 CR: 5 pF·Ω		8		±0.16	20		○				
TLP3340		USOP4 • Ultra-low CR: 5 pF·Ω • C _{OFF} : 0.45 pF (Typ.) • 超低 CR: 5 pF·Ω		3	14	±0.12	40		○				
TLP3341		USOP4 • Ultra-low CR: 5 pF·Ω • C _{OFF} : 0.7 pF (Typ.) • 超低 CR: 5 pF·Ω		10		±0.14			○				
TLP3342		USOP4 • Ultra-low C _{OFF} : 0.3 pF (Typ.) • 超低 C _{OFF} : 0.3 pF (Typ.)		20	5	±0.1	20		○				
TLP3350		USOP4 • Ultra-low CR: 2.5 pF·Ω • C _{OFF} : 0.8 pF (Typ.) • 超低 CR: 2.5 pF·Ω		5		±0.2			○				
TLP3351		USOP4 • Ultra-low C _{OFF} : 0.7 pF (Typ.) • 超低 C _{OFF} : 0.7 pF (Typ.)		15		±0.12	60		○				
TLP3375		USOP4 • C _{OFF} : 12 pF (Typ.)		1.5		±0.3	50		○				

1-Form-A: SSOP4 package 1a 接点シリーズ: SSOP4 パッケージ

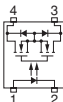
Part Number 品番	Pin Configuration ピン接続図	Features 特長	Trigger LED Current トリガ LED 電流 I _{FT} max (mA)	On-state Resistance オン抵抗 R _{ON}		On-state Current オン電流 I _{ON} max (A)	Off-state Voltage オフ電圧 V _{OFF} (V)	BV _s @ 1 min. 絶縁耐圧 (V _{rms})	Safety Standards ⁽¹⁾ 安全規格				
				max (Ω)	@ I _F (mA)				UL	c-UL	VDE		CQC
											EN 60747-5-5	EN 60065 EN 60950-1	
TLP3203		SSOP4 • Ultra-low On-resistance R: 0.18Ω (Typ.) • High output current I _{ON} : 0.9 A (max) • 超低オン抵抗 • 高出力電流	3	0.22		±0.9	20	1500	○				
TLP3212		SSOP4 • Low CR: 20 pF·Ω • C _{OFF} : 20 pF (Typ.) • 低 CR: 20 pF·Ω	5	1.5	5	±0.4	60		○				
TLP3214		SSOP4 • Ultra-low CR: 10 pF·Ω • C _{OFF} : 5 pF (Typ.) • 超低 CR: 10 pF·Ω	4	3		±0.25	40		○				

Note (1): Please refer to page 43. P.43 をご参照ください。

(1-Form-A: SSOP4 package 1a 接点シリーズ: SSOP4 パッケージ)

Part Number 品番	Pin Configuration ピン接続図	Features 特長	Trigger LED Current トリガ LED 電流 I _{FT} max (mA)	On-state Resistance オン抵抗 R _{ON}		On-state Current オン電流 I _{ON} max (A)	Off-state Voltage オフ電圧 V _{OFF} (V)	BV's @ 1 min. 絶縁耐圧 (Vrms)	Safety Standards ⁽¹⁾ 安全規格				
				max (Ω)	@ I _F (mA)				UL	c-UL	VDE		CQC
											EN 60747-5-5	EN 60065 EN 60950-1	
TLP3215		SSOP4 • Ultra-low CR: 10 pF·Ω • COFF: 10 pF (Typ.) • 超低 CR: 10 pF·Ω	4	1.5		±0.3	40	1500	○				
TLP3216		SSOP4 • Ultra-low CR: 10 pF·Ω • COFF: 1 pF (Typ.) • 超低 CR: 10 pF·Ω											
TLP3217		SSOP4 • Low CR • COFF: 50 pF (Typ.) • 低 CR	5	12		±0.12	80						
TLP3220		SSOP4 • 100-V V _{OFF}							14	10	±0.08	100	
TLP3230		SSOP4 • Ultra-low CR: 5 pF·Ω • COFF: 1 pF (Typ.) • 超低 CR: 5 pF·Ω	4	8		±0.16	20						
TLP3231		SSOP4 • Ultra-low CR: 5 pF·Ω • COFF: 5 pF (Typ.) • 超低 CR: 5 pF·Ω							1.2	±0.45			
TLP3240		SSOP4 • Ultra-low CR: 5 pF·Ω • COFF: 0.45 pF (Typ.) • 超低 CR: 5 pF·Ω	3	14		±0.12	40						
TLP3241		SSOP4 • Ultra-low CR: 5 pF·Ω • COFF: 0.7 pF (Typ.) • 超低 CR: 5 pF·Ω							10	±0.14			
TLP3250		SSOP4 • Ultra-low CR: 2.5 pF·Ω • COFF: 0.8 pF (Typ.) • 超低 CR: 5 pF·Ω							5	±0.2	20		
TLP3275		SSOP4 • COFF: 12 pF (Typ.)		1.5		±0.3	50		○				

1-Form-A: 4 pin SO6 package 1a 接点シリーズ: 4 pin SO6 パッケージ

Part Number 品番	Pin Configuration ピン接続図	Features 特長	Trigger LED Current トリガ LED 電流 I _{FT} max (mA)	On-state Resistance オン抵抗 R _{ON}		On-state Current オン電流 I _{ON} max (A)	Off-state Voltage オフ電圧 V _{OFF} (V)	BV's @ 1 min. 絶縁耐圧 (Vrms)	Safety Standards ⁽¹⁾ 安全規格				
				max (Ω)	@ I _F (mA)				UL	c-UL	VDE		CQC
											EN 60747-5-5	EN 60065 EN 60950-1	
TLP175A		4 pin SO6 • General-purpose • Low trigger current • 汎用タイプ • 低トリガ電流	1	50	2	±0.1	60	3750	○	○	○	○	○

1-Form-A: 2.54SOP4 package 1a 接点シリーズ: 2.54SOP4 パッケージ

Part Number 品番	Pin Configuration ピン接続図	Features 特長	Trigger LED Current トリガ LED 電流 I _{FT} max (mA)	On-state Resistance オン抵抗 R _{ON}		On-state Current オン電流 I _{ON} max (A)	Off-state Voltage オフ電圧 V _{OFF} (V)	BV's @ 1 min. 絶縁耐圧 (Vrms)	Safety Standards ⁽¹⁾ 安全規格				
				max (Ω)	@ I _F (mA)				UL	c-UL	VDE		CQC
											EN 60747-5-5	EN 60065 EN 60950-1	
TLP170A		2.54SOP4 • Low trigger current • General-purpose • 低トリガ電流 • 汎用タイプ	1	2		±0.4	60	1500	○	○	○		
TLP170D				8	2	±0.2	200		○	○	○		
TLP170G				50		±0.1	350		○	○	○		
TLP170J				60		±0.09	600		○	○	○		

Note (1): Please refer to page 43. P.43 をご参照ください。

(1-Form-A: 2.54SOP4 package 1a 接点シリーズ: 2.54SOP4 パッケージ)

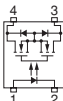
Part Number 品番	Pin Configuration ピン接続図	Features 特長	Trigger LED Current トリガ LED 電流 I _{FT} max (mA)	On-state Resistance オン抵抗 R _{ON}		On-state Current オン電流 I _{ON} max (A)	Off-state Voltage オフ電圧 V _{OFF} (V)	BV _s @ 1 min. 絶縁耐圧 (V _{rms})	Safety Standards ⁽¹⁾ 安全規格					
				max (Ω)	@ I _F (mA)				UL	c-UL	VDE			CQC
											EN 60747-5-5	EN 60065 EN 60950-1		
TLP171A		2.54SOP4 ・ Ultra-low trigger current ・ 超低トリガ電流	0.2	0.5	2	±0.4	60	1500	○	○	○			
TLP171D						±0.2	200		○	○	○			
TLP171GA						±0.1	400		△	△	○			
TLP171J						±0.07	600		○	○	○			
TLP172A		2.54SOP4 ・ High output current ・ General-purpose ・ 高出力電流 ・ 汎用タイプ	3	5	2	±0.4	60		○	○	○			
TLP172G		±0.11				350	○		○	○				
TLP174G		±0.12				350	○		○					
TLP174GA		±0.12				400	○							
TLP176A		2.54SOP4 ・ High output current ・ 高出力電流	3	5	2	±0.4	60		○	○	○			
TLP176D		2.54SOP4 ・ Low On-resistance ・ 低オン抵抗				±0.2	200		○	○	○			
TLP176G		2.54SOP4 ・ General-purpose ・ 汎用タイプ				±0.12	350		○	○	○			
TLP176GA		±0.12				400	○			○				
TLP3114		2.54SOP4 ・ Ultra-low CR: 10 pF · Ω ・ COFF 5 pF (Typ.) ・ 超低 CR: 10 pF · Ω	4	15	3	±0.25	40		○	○	○			
TLP3115		2.54SOP4 ・ Ultra-low CR: 10 pF · Ω ・ COFF 10 pF (Typ.) ・ 超低 CR: 10 pF · Ω				±0.3	40		○	○	○			
TLP3116		2.54SOP4 ・ Ultra-low CR: 10 pF · Ω ・ COFF 1 pF (Typ.) ・ 超低 CR: 10 pF · Ω				±0.12	40		○	○	○			
TLP3118		2.54SOP4 ・ Low CR: 40 pF · Ω ・ COFF 2.5 pF (Typ.), 3.5 pF (max) ・ 低 CR: 40 pF · Ω				±0.04	80		○	○	○			
TLP3119	2.54SOP4 ・ Low CR: 30 pF · Ω ・ COFF 6.5 pF (Typ.), 11 pF (max) ・ 低 CR: 30 pF · Ω	3	8	8	±0.2	80	○	○	○					
TLP3122	2.54SOP4 ・ High output current ・ I _{ON} : 1 A (max) @ Ta: up to 50°C ・ 高出力電流				±1	60	○	○	○					

Note (1): Please refer to page 43. P.43 をご参照ください。

(1-Form-A: 2.54SOP4 package 1a 接点シリーズ: 2.54SOP4 パッケージ)

Part Number 品番	Pin Configuration ピン接続図	Features 特長	Trigger LED Current トリガ LED 電流 I _{FT} max (mA)	On-state Resistance オン抵抗 R _{ON}		On-state Current オン電流 I _{ON} max (A)	Off-state Voltage オフ電圧 V _{OFF} (V)	BV _s @ 1 min. 絶縁耐圧 (Vrms)	Safety Standards ⁽¹⁾ 安全規格				
				max (Ω)	@ I _F (mA)				UL	c-UL	VDE		CQC
											EN 60747-5-5	EN 60065 EN 60950-1	
TLP3123		2.54SOP4 • High output current • I _{ON} : 1 A (max) @ Ta: up to 50°C • 高出力電流	3	0.13	5	±1	40	1500	○	○	○		
TLP3127 *		2.54SOP4 • High output current • I _{ON} : 1.7 A (max) @ Ta: up to 50°C • 高出力電流				0.13	±1.7		60	○	○		
TLP3130		2.54SOP4 • Ultra-low CR: 5 pF · Ω • C _{OFF} 1 pF (Typ.) • 超低 CR: 5 pF · Ω	4	8	±0.16	20	○		○				
TLP3131		2.54SOP4 • Ultra-low CR: 4 pF · Ω • C _{OFF} 5 pF (Typ.) • 超低 CR: 4 pF · Ω		1.2	±0.3	20	○		○				

*: New product / 新製品

1-Form-A: 2.54SOP6 package 1a 接点シリーズ: 2.54SOP6 パッケージ

Part Number 品番	Pin Configuration ピン接続図	Features 特長	Trigger LED Current トリガ LED 電流 I _{FT} max (mA)	On-state Resistance オン抵抗 R _{ON}		On-state Current オン電流 I _{ON} max (A)	Off-state Voltage オフ電圧 V _{OFF} (V)	BV _s @ 1 min. 絶縁耐圧 (Vrms)	Safety Standards ⁽¹⁾ 安全規格				
				max (Ω)	@ I _F (mA)				UL	c-UL	VDE		CQC
											EN 60747-5-5	EN 60065 EN 60950-1	
TLP192A		2.54SOP6 • High output current • 高出力電流	3	5	1500	±0.4	60	1500	○	○			
TLP192G		2.54SOP6				50	±0.11		350	○	○		
TLP197A		2.54SOP6 • High output current • 高出力電流				2	±0.4		60	○	○		
TLP197D		2.54SOP6 • Low On-resistance • 低オン抵抗	8	±0.2	200	○	○						
TLP197G		2.54SOP6	35	±0.12	350	○	○						
TLP197GA		2.54SOP6	35	±0.12	400	○							
TLP3100		2.54SOP6 • Low On-resistance • High output current • I _{ON} : 2.5 A (max) @ Ta: up to 50°C • 低オン抵抗	0.05	±2.5	20	○	○						
TLP3102		2.54SOP6 • High output current • I _{ON} : 2.5 A (max) @ Ta: up to 50°C • C-connection: I _{ON} (DC) = 5.0 A (max) • 高出力電流 • C 接続時: I _{ON} (DC) = 5.0 A (max)	0.06	±2.5	40	○	○						
TLP3103		2.54SOP6 • High output current • I _{ON} : 2.3 A (max) @ Ta: up to 50°C • C-connection: I _{ON} (DC) = 4.6 A (max) • 高出力電流 • C 接続時: I _{ON} (DC) = 4.6 A (max)	0.07	±2.3	60	○	○						

Note (1): Please refer to page 43. P.43 をご参照ください。

(1-Form-A: 2.54SOP6 package 1a 接点シリーズ: 2.54SOP6 パッケージ)

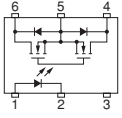
Part Number 品番	Pin Configuration ピン接続図	Features 特長	Trigger LED Current トリガ LED 電流 I _{FT} max (mA)	On-state Resistance オン抵抗 R _{ON}		On-state Current オン電流 I _{ON} max (A)	Off-state Voltage オフ電圧 V _{OFF} (V)	BVs @ 1 min. 絶縁耐圧 (Vrms)	Safety Standards ⁽¹⁾ 安全規格							
				max (Ω)	@ I _F (mA)				UL	c-UL	VDE		CQC			
											EN 60747-5-5	EN 60065 EN 60950-1				
TLP3105		2.54SOP6 ・ High output current ・ I _{ON} : 1.4 A (max) @ Ta: up to 50°C ・ C-connection: I _{ON} (DC) = 2.8 A (max) ・ 高出力電流 ・ C 接続時: I _{ON} (DC) = 2.8 A (max)	3		5	±1.4	100	1500	○	○						
TLP3106 *		2.54SOP6 ・ General-purpose ・ High output current ・ I _{ON} = 4.0 A (max) ・ C-connection: I _{ON} (DC) = 8.0 A (max)							0.2	0.04	±4.0	30	△	△		
TLP3107 *		2.54SOP6 ・ High output current ・ I _{ON} : 3.3 A (max) @ Ta: up to 50°C ・ C-connection: I _{ON} (DC) = 6.6 A (max) ・ 高出力電流 ・ C 接続時: I _{ON} (DC) = 6.6 A (max)							0.06	±3.3	60	○	○			
TLP3109 *		2.54SOP6 ・ General-purpose ・ High output current ・ I _{ON} = 2.0 A (max) ・ C-connection: I _{ON} (DC) = 4.0 A (max)							0.07	±2.0	100	△	△			
TLP3120		2.54SOP6 ・ High output current ・ I _{ON} : 1.25 A (max) ・ 高出力電流							5	0.15	±1.25	80	○	○		

*: New product / 新製品

1-Form-A: 2.54SOP8 package 1a 接点シリーズ: 2.54SOP8 パッケージ)

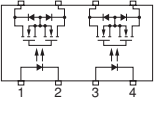
Part Number 品番	Pin Configuration ピン接続図	Features 特長	Trigger LED Current トリガ LED 電流 I _{FT} max (mA)	On-state Resistance オン抵抗 R _{ON}		On-state Current オン電流 I _{ON} max (A)	Off-state Voltage オフ電圧 V _{OFF} (V)	BVs @ 1 min. 絶縁耐圧 (Vrms)	Safety Standards ⁽¹⁾ 安全規格						
				max (Ω)	@ I _F (mA)				UL	c-UL	VDE		CQC		
											EN 60747-5-5	EN 60065 EN 60950-1			
TLP200D		2.54SOP8 ・ Dual channel version of the TLP176D ・ TLP176D の 2 回路タイプ	3		5	±0.2	200	1500	○						
TLP202A		2.54SOP8 ・ Dual channel version of the TLP172A ・ TLP172A の 2 回路タイプ							8	2	±0.4	60	○		
TLP202G		2.54SOP8 ・ Dual channel version of the TLP172G ・ TLP172G の 2 回路タイプ							50	±0.11	350	○	○		
TLP206A		2.54SOP8 ・ Dual channel version of the TLP176A ・ TLP176A の 2 回路タイプ							2	±0.4	60	○			
TLP206G		2.54SOP8 ・ Dual channel version of the TLP176G ・ TLP176G の 2 回路タイプ							35	±0.12	350	○	○		
TLP206GA		2.54SOP8 ・ Dual channel version of the TLP176GA ・ TLP176GA の 2 回路タイプ							35	±0.12	400	○	○		
TLP3125		2.54SOP8 ・ Low On-resistance ・ 低オン抵抗							4	±0.2	400	○	○		

Note (1): Please refer to page 43. P.43 をご参照ください。

1-Form-A: DIP4 package 1a 接点シリーズ: DIP4 パッケージ

Part Number 品番	Pin Configuration ピン接続図	Features 特長	Trigger LED Current トリガ LED 電流 I _{FT} max (mA)	On-state Resistance オン抵抗 R _{ON}		On-state Current オン電流 I _{ON} max (A)	Off-state Voltage オフ電圧 V _{OFF} (V)	BVs @ 1 min. 絶縁耐圧 (Vrms)	Safety Standards ⁽¹⁾ 安全規格					
				max (Ω)	@ I _F (mA)				UL	c-UL	VDE		CQC	
											EN 60747-5-5	EN 60065 EN 60950-1		
TLP222A		DIP4 ・ High output current ・ General-purpose ・ 高出力電流 ・ 汎用タイプ	3	5	2	±0.5	60	2500	○	○				
TLP222D		DIP4 ・ High output current ・ General-purpose ・ 高出力電流 ・ 汎用タイプ			8	±0.3	200		○	○				
TLP222G		DIP4 ・ General-purpose ・ 汎用タイプ			50	±0.12	350		○	○				
TLP224G		DIP4 ・ Current-limiting function ・ Limit current 150 to 300 mA ・ 電流制限機能付 ・ リミット電流: 150 ~ 300 mA			35	±0.12	350		○	○				
TLP224GA		DIP4 ・ Current-limiting function ・ Limit current 150 to 300 mA ・ 電流制限機能付 ・ リミット電流: 150 ~ 300 mA			35	±0.12	400							
TLP225A		DIP4 ・ For DC use only ・ DC 専用			1.1	0.5	60		○	○				
TLP227A		DIP4 ・ General-purpose ・ 汎用タイプ			2	±0.5	60	5000	○	○				
TLP227G		DIP4 ・ General-purpose ・ 汎用タイプ	35	±0.12	350	○	○		○					
TLP227GA		DIP4 ・ General-purpose ・ 汎用タイプ	35	±0.12	400	○								
TLP228G		DIP4 ・ High EMI immunity ・ General-purpose ・ 高 EMI 耐量 ・ 汎用タイプ	50	±0.12	350	○	○							
TLP240A		*	DIP4 ・ Reinforced insulation ・ General-purpose ・ 強化絶縁対応 ・ 汎用タイプ			2	±0.5		60	5000	○	○	○	
TLP240AF	*				8	±0.25	200	○	○		○		○	
TLP240D	*				50	±0.1	350	○	○		○		○	
TLP240DF	*				35	±0.12	400	○	○		○		○	
TLP240G	*				60	±0.09	600	○	○		○		○	
TLP240GF	*				0.2	±2.0	40	○	○		○		○	
TLP240GA	*													
TLP240GAF	*													
TLP240J	*													
TLP240JF	*													
TLP241A	*													
TLP241AF	*													
TLP3553		DIP4 ・ High output current ・ I _{ON} : 3.0 A (max) @ Ta = 25°C ・ 高出力電流			0.08	±3	20	2500	○	○				
TLP3554		DIP4 ・ High output current ・ I _{ON} : 2.5 A (max) @ Ta = 25°C ・ 高出力電流			0.15	±2.5	40		○	○				
TLP3555		DIP4 ・ High output current ・ I _{ON} : 2.0 A (max) @ Ta = 25°C ・ 高出力電流			0.2	±2	60		○	○				
TLP3556		DIP4 ・ High output current ・ I _{ON} : 1.0 A (max) @ Ta = 25°C ・ 高出力電流			0.7	±1	100		○	○				

Note (1): Please refer to page 43. P.43 をご参照ください。

*: New product / 新製品

1-Form-A: DIP6 package 1a 接点シリーズ: DIP6 パッケージ

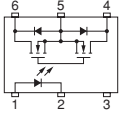
Part Number 品番	Pin Configuration ピン接続図	Features 特長	Trigger LED Current トリガ LED 電流 I _{FT} max (mA)	On-state Resistance オン抵抗 R _{ON}		On-state Current オン電流 I _{ON} max (A)	Off-state Voltage オフ電圧 V _{OFF} (V)	BV _s @ 1 min. 絶縁耐圧 (V _{rms})	Safety Standards ⁽¹⁾ 安全規格				
				max (Ω)	@ I _F (mA)				UL	c-UL	VDE		CQC
											EN 60747-5-5	EN 60065 EN 60950-1	
TLP592A		DIP6 ・ High output current ・ 高出力電流	3	2	5	±0.5	60	2500	○				
TLP592G		DIP6 ・ General-purpose ・ 汎用タイプ		50		±0.12	350		○				
TLP597A		DIP6 ・ High output current ・ 高出力電流		2		±0.5	60		○				
TLP597G		DIP6 ・ General-purpose ・ 汎用タイプ		35		±0.12	350		○	○			
TLP597GA		DIP6 ・ General-purpose ・ 汎用タイプ		35		±0.12	400		○				
TLP598AA		DIP6 ・ High output current ・ 高出力電流		2		±0.5	60		○				
TLP598GA		DIP6 ・ Low On-resistance ・ 低オン抵抗		12		±0.15	400		○				
TLP797GA TLP797GAF		DIP6 ・ High isolation voltage ・ 高絶縁耐圧		35		5	±0.12		400	○	○	○	
TLP797J TLP797JF		DIP6 ・ High isolation voltage ・ 高絶縁耐圧	5	45	10	±0.1	600	5000	○	○	○		
TLP798GA		DIP6 ・ High isolation voltage ・ Low On-resistance ・ 高絶縁耐圧 ・ 低オン抵抗	12	5	±0.15	400	○	○					
TLP3542		5 pin DIP6 (cut) ・ Low On-resistance ・ High output current ・ I _{ON} : 2.5 A (max) @ Ta = 25°C ・ 低オン抵抗 ・ 高出力電流	0.1	10	±2.5	60	○	○					
TLP3543		DIP6 ・ High output current ・ I _{ON} : 4.0 A (max) @ Ta = 25°C ・ 高出力電流	3	0.05	5	±4	20	2500	○	○			
TLP3544		DIP6 ・ High output current ・ I _{ON} : 3.5 A (max) @ Ta = 25°C ・ 高出力電流		0.06		±3.5	40		○	○			
TLP3545	DIP6 ・ High output current ・ I _{ON} : 3.0 A (max) @ Ta = 25°C ・ 高出力電流	0.07		±3		60	○		○				
TLP3546	DIP6 ・ High output current ・ I _{ON} : 2.0 A (max) @ Ta = 25°C ・ 高出力電流	0.2		±2		100	○		○				

Note (1): Please refer to page 43. P.43 をご参照ください。

1-Form-A: DIP8 package 1a 接点シリーズ: DIP8 パッケージ

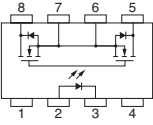
Part Number 品番	Pin Configuration ピン接続図	Features 特長	Trigger LED Current トリガ LED 電流 I _{FT} max (mA)	On-state Resistance オン抵抗 R _{ON}		On-state Current オン電流 I _{ON} max (A)	Off-state Voltage オフ電圧 V _{OFF} (V)	BV's @ 1 min. 絶縁耐圧 (Vrms)	Safety Standards ⁽¹⁾ 安全規格					
				max (Ω)	@ I _F (mA)				UL	c-UL	VDE			CQC
											EN 60747-5-5	EN 60065 EN 60950-1		
TLP3547 **		DIP8 ・ High output current ・ I _{ON} = 5 A (max) @ Ta = 25°C ・ 高出力電流	5	0.05	5	±5.0	60	2500	△	△				
TLP3548 **		DIP8 ・ High output current ・ I _{ON} = 0.4 A (max) @ Ta = 25°C ・ 高出力電流	1	5	2	±0.4	400		△	△				
TLP3549 **		DIP8 ・ High output current ・ I _{ON} = 0.6 A (max) @ Ta = 25°C ・ 高出力電流	5	2	5	±0.6	600		△	△				

** : Under development / 開発中

2-Form-A 2a 接点シリーズ

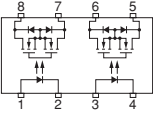
Part Number 品番	Pin Configuration ピン接続図	Features 特長	Trigger LED Current トリガ LED 電流 I _{FT} max (mA)	On-state Resistance オン抵抗 R _{ON}		On-state Current オン電流 I _{ON} max (A)	Off-state Voltage オフ電圧 V _{OFF} (V)	BV's @ 1 min. 絶縁耐圧 (Vrms)	Safety Standards ⁽¹⁾ 安全規格					
				max (Ω)	@ I _F (mA)				UL	c-UL	VDE			CQC
											EN 60747-5-5	EN 60065 EN 60950-1		
TLP222A-2		DIP8 ・ Dual channel version of the TLP222A ・ TLP222A の 2 回路タイプ		2		±0.5	60	2500	○	○				
TLP222G-2		DIP8 ・ Dual channel version of the TLP222G ・ TLP222G の 2 回路タイプ		50		350	○		○					
TLP224G-2		DIP8 ・ Dual channel version of the TLP224G ・ TLP224G の 2 回路タイプ		35		350	○		○					
TLP224GA-2		DIP8 ・ Dual channel version of the TLP224GA ・ Current-limiting function ・ Limit current: 150 to 300 mA ・ TLP224GA の 2 回路タイプ ・ 電流制御機能付 ・ リミット電流: 150 ~ 300 mA	3	35	5	±0.12	400		○	○				
TLP227A-2		DIP8 ・ Dual channel version of the TLP227A ・ TLP227A の 2 回路タイプ		2		±0.5	60		○	○				
TLP227G-2		DIP8 ・ Dual channel version of the TLP227G ・ TLP227G の 2 回路タイプ		35		350	○		○	○				
TLP227GA-2		DIP8 ・ Dual channel version of the TLP227GA ・ TLP227GA の 2 回路タイプ		35		±0.12	400		○	○				
TLP228G-2		DIP8 ・ Dual channel version of the TLP228G ・ TLP228G の 2 回路タイプ		50		350	○		○					

Note (1): Please refer to page 43. P.43 をご参照ください。

1-Form-B 1b 接点シリーズ

Part Number 品番	Pin Configuration ピン接続図	Features 特長	Trigger LED Current トリガ LED 電流 I_{FT} max (mA)	On-state Resistance オン抵抗 R_{ON}		On-state Current オン電流 I_{ON} max (A)	Off-state Voltage オフ電圧 V_{OFF} (V)	BVs @ 1 min. 絶縁耐圧 (Vrms)	Safety Standards ⁽¹⁾ 安全規格				
				max (Ω)	@ I_F (mA)				UL	c-UL	VDE		CQC
											EN 60747-5-5	EN 60065 EN 60950-1	
TLP4176G		2.54SOP4 ・ General-purpose ・ 汎用タイプ	3	25	0	± 0.12	350	1500	○				
TLP4197G		2.54SOP4 ・ General-purpose ・ 汎用タイプ							○				
TLP4227G		DIP4 ・ General-purpose ・ 汎用タイプ				± 0.15	2500	○					
TLP4597G		DIP6 ・ General-purpose ・ 汎用タイプ				3	25	0	± 0.15	350	2500	○	

2-Form-B 2b 接点シリーズ

Part Number 品番	Pin Configuration ピン接続図	Features 特長	Trigger LED Current トリガ LED 電流 I_{FT} max (mA)	On-state Resistance オン抵抗 R_{ON}		On-state Current オン電流 I_{ON} max (A)	Off-state Voltage オフ電圧 V_{OFF} (V)	BVs @ 1 min. 絶縁耐圧 (Vrms)	Safety Standards ⁽¹⁾ 安全規格				
				max (Ω)	@ I_F (mA)				UL	c-UL	VDE		CQC
											EN 60747-5-5	EN 60065 EN 60950-1	
TLP4206G		2.54SOP8 ・ Dual channel version of the TLP4176G ・ TLP4176G の 2 回路タイプ	3	25	0	± 0.12	350	1500	○				
TLP4227G-2		DIP8 ・ Dual channel version of the TLP4227G ・ TLP4227G の 2 回路タイプ							± 0.15	2500	○		

1-FormA, 1-Form-B 1a1b 接点シリーズ

Part Number 品番	Pin Configuration ピン接続図	Features 特長	Trigger LED Current トリガ LED 電流 I_{FT} max (mA)	On-state Resistance オン抵抗 R_{ON}		On-state Current オン電流 I_{ON} max (A)	Off-state Voltage オフ電圧 V_{OFF} (V)	BVs @ 1 min. 絶縁耐圧 (Vrms)	Safety Standards ⁽¹⁾ 安全規格				
				max (Ω)	@ I_F (mA)				UL	c-UL	VDE		CQC
											EN 60747-5-5	EN 60065 EN 60950-1	
TLP4006G		DIP8 ・ General-purpose ・ 汎用タイプ	3	25	0	1-Form-A: 5 1-Form-B: 0	350	2500					
TLP4026G		2.54SOP8 ・ General-purpose ・ 汎用タイプ						1500	○				

Note (1): Please refer to page 43. P.43 をご参照ください。

Reference

Note (1): Certified to safety standards. For details on certification status, contact your Toshiba sales representative.

UL/c-UL/CQC: ○: Approved △: Approval pending as of October 2015

VDE: ○: Approved (EN 60747-5-5 / EN 60065 / EN 60950-1-certified)

△: Approval pending as of October 2015

Specify VDE-certified devices with option V4 or D4

UL: Underwriters Laboratories (UL) is a safety consulting and certification company.

c-UL: c-UL Mark is the UL Mark for Canada.

VDE: VERBAND DEUTSCHER ELECTROTECHNISCHER e.V.

CQC: China Quality Certification center

(2): The products with the ranks Y and BL are limited in production. For details, please contact your local Toshiba sales representative.

(3): For details of the devices, please contact your local Toshiba sales representative.

(4): This product is for Japan.

参照

Note (1): 安全規格適合品であることを示します。認定状況の詳細につきましては、当社営業窓口までお問い合わせください。

UL/c-UL/CQC: ○印は認定品、△印は申請中 (2015年10月現在)。

VDE: ○印は認定品 (EN 60747-5-5 / EN 60065 / EN 60950-1 適合)、△印は申請中 (2015年10月現在)。

オプション (V4) または (D4) にて、VDE 認定を指定してください。

UL: Underwriters Laboratories 米国安全規格

c-UL: CSA (Canadian Standards Association) 相当のカナダ向け米国安全規格

VDE: VERBAND DEUTSCHER ELECTROTECHNISCHER e.V.

CQC: China Quality Certification center 中国品質認証センター

(2): Yランク品およびBLランク品は生産上制限のある製品です。詳細につきましては当社営業窓口までお問い合わせください。

(3): 製品の詳細につきましては、当社営業窓口までお問い合わせください。

(4): 日本国内向け製品です。

Package Dimensions パッケージ外形寸法図

Unit: mm / 単位: mm

▶ 4 pin DIP type 4ピンDIPタイプ

DIP4 (standard)	DIP4 (LF1)	DIP4 (LF2) / DIP4 (F type)
<p>Top view: 6.4 ± 0.25, 4.58 ± 0.25, 3.65^{+0.15}/_{-0.25}, 7.62 ± 0.25, 0.25^{+0.1}/_{-0.05}, 7.85 to 8.80</p> <p>Side view: 1.2 ± 0.15, 0.5 ± 0.1, 2.54 ± 0.25, 0.8 ± 0.25, 2.5 min</p>	<p>Top view: 6.4 ± 0.25, 4.58 ± 0.25, 3.65^{+0.15}/_{-0.25}, 7.62 ± 0.25, 1.2 ± 0.15, 2.54 ± 0.25</p> <p>Side view: 1.0 min, 10.0 max, 4.0^{+0.25}/_{-0.25}</p>	<p>Top view: 6.4 ± 0.25, 10.16 ± 0.25, 7.62 ± 0.25, 0.25^{+0.1}/_{-0.05}, 10 to 12</p> <p>Side view: 1.2 ± 0.15, 0.5 ± 0.1, 2.54 ± 0.25, 0.25 min, 2.5 min</p>
DIP4 (LF4)	DIP4 (LF5)	TLP785 (standard)
<p>Top view: 6.4 ± 0.25, 4.58 ± 0.25, 3.65^{+0.15}/_{-0.25}, 7.62 ± 0.25, 0.25^{+0.1}/_{-0.05}, 12.0 max, 3.9^{+0.25}/_{-0.25}</p> <p>Side view: 1.2 ± 0.15, 2.54 ± 0.25, 1.2 ± 0.15, 0.75 ± 0.25, 0.25 ± 0.1</p>	<p>Top view: 6.4 ± 0.25, 4.58 ± 0.25, 3.65^{+0.15}/_{-0.25}, 7.62 ± 0.25, 1.2 ± 0.15, 2.54 ± 0.25</p> <p>Side view: 1.0 min, 10.0 max, 0.2 max, 3.85^{+0.25}/_{-0.20}, 0.25^{+0.1}/_{-0.05}</p>	<p>Top view: 6.5 ± 0.25, 4.6 ± 0.25, 7.62 ± 0.3, 0.26 ± 0.1, 7.85 to 8.8</p> <p>Side view: 2.8 ± 0.25, 0.5 ± 0.1, 2.54 ± 0.25, 3.5 ± 0.25, 3.3 ± 0.25, 0.5</p>
TLP785F (TLP785 F type)	TLP785 (LF6)	TLP785F (LF7)
<p>Top view: 6.5 ± 0.25, 10.16 ± 0.25, 7.62 ± 0.3, 0.26 ± 0.1, 6.8 ± 0.5, 10 to 12</p> <p>Side view: 1.2 ± 0.15, 0.5 ± 0.1, 2.54 ± 0.25, 4.6 ± 0.25, 3.5 ± 0.25, 2.3 ± 0.25, 0.26 ± 0.1, 6.8 ± 0.5</p>	<p>Top view: 6.5 ± 0.25, 4.6 ± 0.25, 7.62 ± 0.3, 0.26 ± 0.1, 10.0 ± 0.3</p> <p>Side view: 1.2 ± 0.15, 2.54 ± 0.25, 0.1 ± 0.1, 1.0 ± 0.2, 10.0 ± 0.3, 0.26 ± 0.1</p>	<p>Top view: 6.5 ± 0.25, 4.6 ± 0.25, 7.62 ± 0.3, 0.26 ± 0.1, 11.66 ± 0.3</p> <p>Side view: 1.2 ± 0.15, 2.54 ± 0.25, 0.25 ± 0.1, 4.6 ± 0.25, 3.5 ± 0.25, 0.75 ± 0.25, 11.66 ± 0.3, 0.26 ± 0.1</p>
▶ 6 pin DIP type 6ピンDIPタイプ		
DIP6 (standard)	DIP6 (LF1)	DIP6 (LF2) / DIP6 (F type)
<p>Top view: 6.4 ± 0.25, 7.12 ± 0.25, 3.65^{+0.15}/_{-0.25}, 7.62 ± 0.25, 0.25^{+0.1}/_{-0.05}, 7.85 to 8.80</p> <p>Side view: 0.5 ± 0.1, 2.54 ± 0.25, 1.2 ± 0.15, 0.8 ± 0.25, 2.5 min</p>	<p>Top view: 6.4 ± 0.25, 7.12 ± 0.25, 3.65^{+0.15}/_{-0.25}, 7.62 ± 0.25, 1.2 ± 0.15, 2.54 ± 0.25</p> <p>Side view: 1.0 min, 10.0 max, 4.0^{+0.25}/_{-0.25}</p>	<p>Top view: 6.4 ± 0.25, 10.16 ± 0.25, 7.62 ± 0.25, 0.25^{+0.1}/_{-0.05}, 10 to 12</p> <p>Side view: 0.5 ± 0.1, 2.54 ± 0.25, 1.2 ± 0.15, 0.25 min, 2.5 min</p>

* All dimensions are for reference only unless tolerance is given.
* 公差を表示していない寸法は参考値を示します。

▶ 6 pin DIP type 6ピンDIPタイプ

DIP6 (LF4)	DIP6 (LF5)

▶ 8 pin DIP type 8ピンDIPタイプ

DIP8 (standard)	DIP8 (LF1)	DIP8 (LF2) / DIP8 (F type)

DIP8 (LF4)	DIP8 (LF5)

▶ Other DIP type / SDIP type その他DIPタイプ / SDIPタイプ

5 pin DIP6	5 pin DIP6 (LF2)	5 pin DIP6 (cut)

SDIP6	SDIP6 (F type)

* All dimensions are for reference only unless tolerance is given.
* 公差を表示していない寸法は参考値を示します。

▶ MFC (Mini Flat Coupler) type MFCタイプ

4 pin MFSOP6	4 pin MFSOP6 (No.5cut)	5 pin MFSOP6

▶ 2.54 SOP type 2.54 SOPタイプ

2.54 SOP4	2.54 SOP6	2.54 SOP8

▶ SOP/SSOP/USOP/VSON type SOP/SSOP/USOP/VSONタイプ

SOP16	SSOP4	USOP4

VSON4

▶ SO type SOタイプ

SO4	4 pin SO6	5 pin SO6

* All dimensions are for reference only unless tolerance is given.
 * 公差を表示していない寸法は参考値を示します。

▶ SO type SOタイプ

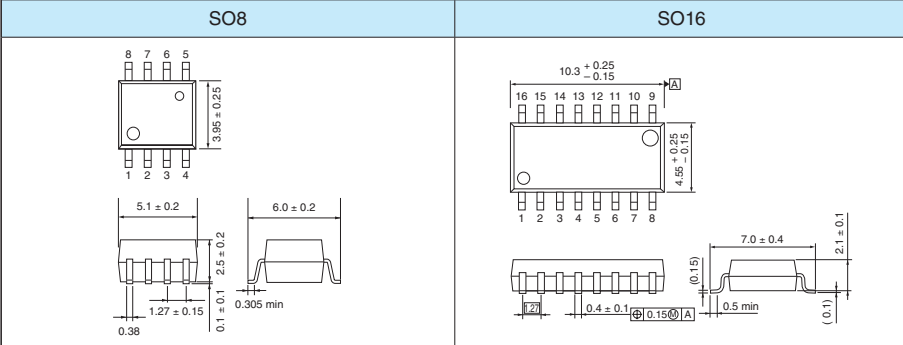

▶ SOL type SOLタイプ

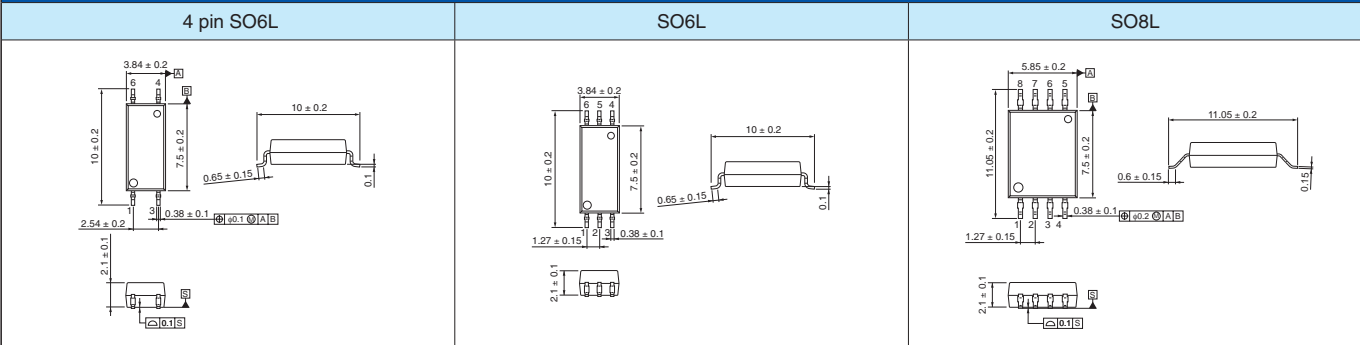

SO16L

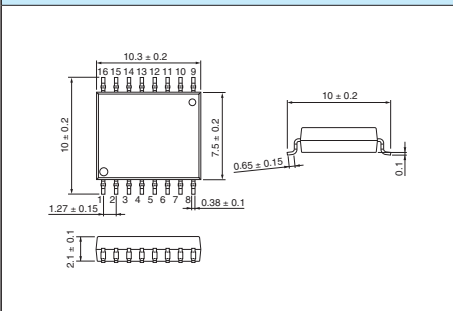

* All dimensions are for reference only unless tolerance is given.
 * 公差を表示していない寸法は参考値を示します。

Lead Form Options for DIP Packages DIP パッケージ品の標準リードフォーミング

The DIP4, DIP6 and DIP8 packages offer three surface-mount lead form options and a wide-spaced lead form option. The electrical characteristics are identical, regardless of these options.

DIP4/DIP6/DIP8 パッケージ品は、リードフォーミングを指定することで、表面実装が可能となります。長沿面実装用リードフォーミングも可能です。電気的特性は、標準製品と同じです。

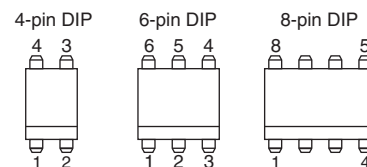

Lead Form リードフォーミング	Surface-Mount 表面実装			Wide-Spaced 長沿面実装																																		
Appearance 外觀写真																																						
Lead Form Code フォーミング名称	(LF1)	(LF4), (LF7) ⁽²⁾	(LF5), (LF6) ⁽²⁾	(LF2), (F type)																																		
Carrier Tape Code テーピング包装指定	(TP1)	(TP4), (TP7) ⁽²⁾	(TP5), (TP6) ⁽²⁾	Not available ⁽¹⁾ なし ⁽¹⁾																																		
Package Outline 外形	 Dimensions 寸法 (mm) <table border="1"> <thead> <tr> <th rowspan="2">Dimension 寸法</th> <th colspan="2">(LF1)</th> <th colspan="2">(LF4)</th> <th colspan="2">(LF5)</th> </tr> <tr> <th>min</th> <th>max</th> <th>min</th> <th>max</th> <th>min</th> <th>max</th> </tr> </thead> <tbody> <tr> <td>A</td> <td>—</td> <td>10.0</td> <td>—</td> <td>12.0</td> <td>—</td> <td>10.0</td> </tr> <tr> <td>B</td> <td colspan="2">(0.35 typ.)</td> <td colspan="2">(0.25 typ.)</td> <td>—</td> <td>0.2</td> </tr> <tr> <td>C</td> <td>6.4</td> <td>—</td> <td>8.0</td> <td>—</td> <td>6.4</td> <td>—</td> </tr> </tbody> </table> ・ All other package dimensions are the same as for each standard package specification. ・ 他部分の外形寸法は標準製品の寸法に同じ。			Dimension 寸法	(LF1)		(LF4)		(LF5)		min	max	min	max	min	max	A	—	10.0	—	12.0	—	10.0	B	(0.35 typ.)		(0.25 typ.)		—	0.2	C	6.4	—	8.0	—	6.4	—	
Dimension 寸法	(LF1)		(LF4)		(LF5)																																	
	min	max	min	max	min	max																																
A	—	10.0	—	12.0	—	10.0																																
B	(0.35 typ.)		(0.25 typ.)		—	0.2																																
C	6.4	—	8.0	—	6.4	—																																

- (1) Tape-and-reel packing is not available with (LF2).
 (2) The package dimensions and lead form options of the TLP785 differ from those shown above. See the TLP785 datasheet.
 (3) Standard part names should be used when applying for safety standard approval.

- (1) (LF2) のテーピング包装はありません。
 (2) TLP781、TLP785 は、外形寸法とリードフォーミング名称が異なります。個別データシートをご参照ください。
 (3) 安全規格申請時には標準品名称にて、申請を行ってください。

Example Land Patterns 参考パッド寸法

Unit: mm / 単位: mm

DIP (surface-mount lead form) ⁽¹⁾		SDIP		
DIP (LF1) / (LF5)	DIP (LF4) / (F type)	SDIP6	SDIP6 (F type)	
MFC		2.54 SOP		
4pin MFSOP6	5pin MFSOP6	2.54SOP4	2.54SOP6	2.54SOP8
SOP/SSOP/USOP/VSON				
SOP4	SOP16	SSOP4	USOP4	VSON4
SO				
SO4	4pin SO6	5pin SO6	SO8	SO16
SOL				
4pin SO6L	SO6L	SO8L	SO16L	

* The PCB land Pattern dimensions shown above are for reference only and should be determined empirically.

(1) For the example land patterns for the TLP785, see their respective datasheets.

* パッド寸法は参考です。お客さまでの実装の確認をお願いします。

(1) TLP785のパッド寸法は、個別データシートを参照してください。

Rank Marking 製品ランク表示

Transistor-output photocouplers are ranked according to their CTR (Current Transfer Ratio) ranges, whereas thyristor-output and triac-output photocouplers are ranked according to their maximum I_{FT} value. The following gives the rank classifications and rank marks printed on packages. Note that the rank classifications differ from product to product. For details, please refer to the relevant technical datasheets.

トランジスタ出力に対する CTR (Current Transfer Ratio) の標準ランク分類、およびサイリスタ、トライアック出力に対する I_{FT} の標準ランク分類を実施しています。ランク名称と対応する製品表示は次のとおりです。ただし、適用するランク分類は製品によって異なりますので、詳しくは各個別技術資料で確認ください。

CTR Rank Name and Rank Marking (for Transistor-output)

変換効率 (CTR) 分類と製品表示 (トランジスタ出力)

Available CTR Rank Selection (○ Available, △ Contact your nearest Toshiba sales representative)

CTR ランク分類に対する適用は次のとおりです (○: 適用中、△: 当社営業窓口にお問い合わせください)。

Input Type 入力タイプ	Rank Name ランク名称	None なし		Y	YH	GR	GRL	GRH	GB		BL	BLL	LA	LGB	
	CTR Rank Marking CTR ランク表示記号	Blank 無印		YE	Y+	GR	G	G+	GB		BL	B	LA (*)	LB (*)	
	CTR	max	50	50	50	75	100	100	150	100	100	200	200	50	100
	min	400	600	150	150	300	200	300	400	600	600	400	600	600	600
DC Input DC 入力	TLP183		○	○	○	○	○	○		○	○	○			
	TLP185(SE)		○	○	○	○	○	○		○	○	○			
	TLP188		○							○					
	TLP291-4	○							○						
	TLP291(SE)		○	○	○	○	○	○		○	○	○			
	TLP293		○	○	○	○	○	○		○	○	○			
	TLP293-4		○							○			○	○	
	TLP383		○	○	○	○	○	○		○	○	○			
	TLP385		○	○	○	○	○	○		○	○	○			
	TLP388		○							○					
	TLP731		○	△			○			○	△				
	TLP732		○	△			○			○	△				
	TLP785/785F		○	○	○	○	○	○		○	○	○			
	TLP2301		○							○					
	TLP2701		○							○					
AC Input AC 入力	TLP182		○	○		○				○	○				
	TLP184(SE)		○	○		○				○	○				
	TLP290-4	○							○						
	TLP290(SE)		○	○		○				○	○				
	TLP292		○	○		○				○	○				
TLP292-4												○	○		

(*): The LA and LB rank are made CTR rank of the low input current condition.

(*): LA、LB ランクは、低入力電流条件下の CTR ランクです。

Marking Examples 製品表示例

(a) DIP4 Package (TLP785)

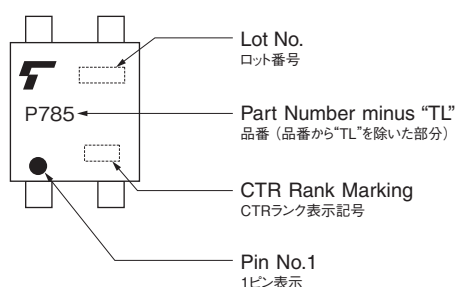

(b) SO4 Package (TLP291)

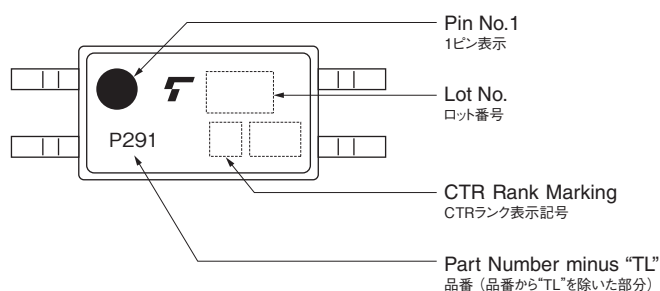

LED Trigger Current (I_{FT}) Rank Name and Rank Marking (for Triac-output)

トリガ LED 電流 (I_{FT}) 分類と製品表示 (トライアック出力)

Off-state Output Terminal Voltage せん頭順阻止電圧 V _{DRM}	Part Number 品番	Trigger LED Current トリガ LED 電流 I _{FT} (mA) max				
		Rank Name ランク名称	None	IFT7	IFT5	IFT2
		I _{FT} Rank Marking I _{FT} ランク表示記号	Blank	T7	T5	T2
400 V	TLP560G	10	7	5	—	
	TLP561G	10	7	5	—	
	TLP665G(S)* / TLP665GF(S)*	10	7	—	—	
	TLP666G(S)* / TLP666GF(S)*	10	7	—	—	
600 V	TLP265J	10	7	—	—	
	TLP266J	10	7	—	—	
	TLP267J	3	—	—	2	
	TLP268J	3	—	—	2	
	TLP360J / TLP360JF	10	7	—	—	
	TLP361J / TLP361JF	10	7	—	—	
	TLP560J	10	7	—	—	
	TLP561J	10	7	—	—	
	TLP665J(S)* / TLP665JF(S)*	10	7	—	—	
	TLP666J(S)* / TLP666JF(S)*	10	7	—	—	
800 V	TLP665L*	10	7	—	—	
	TLP669L(S)* / TLP669LF(S)*	10	—	5	—	

*: Product for Japan / 日本国内向け製品

Marking Examples 製品表示例

(a) 4 pin SO6 Package (TLP265J)

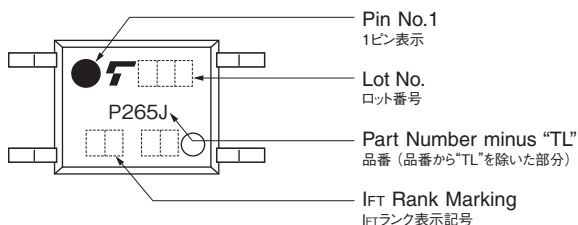

(b) 5 pin DIP6 Package (TLP665L)

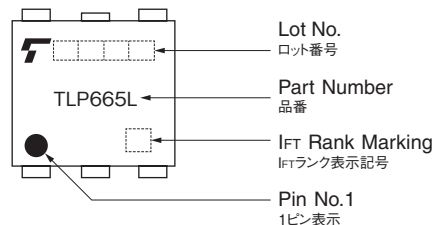

Note: 1. Specify both the part number and a rank in this format when ordering.

Examples: TLP183 (GB), TLP560G (T7)

2. For safety standard certification, however, specify the part number alone.

Examples: $\frac{\text{Part number}}{\text{TLP183 (GB)}} \rightarrow \frac{\text{Use this part number}}{\text{TLP183}}$

注: 1. 製品型名を指定する場合、型名と分類名称を組み合わせてください。

(例): TLP183 (GB)、TLP560G (T7)

2. 安全規格認定のための型名申請は標準製品型名を使用してください。

(例) $\frac{\text{品番}}{\text{TLP183(GB)}} \rightarrow \frac{\text{申請形名}}{\text{TLP183}}$

Magazine Packing Specification マガジン包装仕様

Unit: mm / 単位: mm

DIP type DIP タイプ		Standard 標準			Lead Forming リードフォーミング LF1, LF2 / F type, LF4 / LF7, LF5 / LF6			
Magazine マガジン	Dimensions 断面形状							
	Pin Count ピンタイプ	4 pin	6 pin	8 pin	4 pin	6 pin	8 pin	
	Quantities per Magazine 1 マガジン当りの詰め数	100 pcs	50 pcs	50 pcs	100 pcs	50 pcs	50 pcs	
Carton 包装箱	Number of Magazines 1 箱当りのマガジン数	4	20	60	4	40		
	Carton Dimensions 包装箱寸法	A	50 mm	67 mm	123 mm	60 mm	135 mm	
		B	12 mm	51 mm	76 mm	13 mm	58 mm	
		C	531 mm	559 mm	568 mm	531 mm	568 mm	
Label Position ラベル位置	Y	Y	X	Y	X			

Unit: mm / 単位: mm

SDIP type SDIP タイプ		SDIP6		
Magazine マガジン	Dimensions 断面形状			
	Quantities per Magazine 1 マガジン当りの詰め数	100 pcs		
Carton 包装箱	Number of Magazines 1 箱当りのマガジン数	40		
	Carton Dimensions 包装箱寸法	A	135 mm	
		B	58 mm	
		C	568 mm	
Label Position ラベル位置	X			

Unit: mm / 単位: mm

MFC type MFC タイプ		MFSOP6			
Magazine マガジン	Dimensions 断面形状				
	Quantities per Magazine 1 マガジン当りの詰め数	150 pcs			
Carton 包装箱	Number of Magazines 1 箱当りのマガジン数	4	24	40	
	Carton Dimensions 包装箱寸法	A	29 mm	77 mm	67 mm
		B	13 mm	31 mm	55 mm
		C	563 mm	586 mm	586 mm
Label Position ラベル位置	Y	Y	X		

Unit: mm / 単位: mm

2.54 SOP type 2.54 SOP タイプ		2.54 SOP			
Magazine マガジン	Dimensions 断面形状				
	Pin Count ピンタイプ	4 (2.54 SOP4)	6 (2.54 SOP6)	8 (2.54 SOP8)	
	Quantities per Magazine 1 マガジン当りの詰め数	100 pcs	75 pcs	50 pcs	
Carton 包装箱	Number of Magazines 1 箱当りのマガジン数	4	24	40	
	Carton Dimensions 包装箱寸法	A	29 mm	77 mm	67 mm
		B	13 mm	31 mm	55 mm
		C	563 mm	586 mm	586 mm
Label Position ラベル位置	Y	Y	X		

Unit: mm / 単位: mm

SOP type SOP タイプ		SOP			
Magazine マガジン	Dimensions 断面形状				
	Pin Count ピンタイプ	4 (SOP4)	16 (SOP16)		
	Quantities per Magazine 1 マガジン当りの詰め数	150 pcs	50 pcs		
Carton 包装箱	Number of Magazines 1 箱当りのマガジン数	4	24	40	
	Carton Dimensions 包装箱寸法	A	29 mm	77 mm	67 mm
		B	13 mm	31 mm	55 mm
		C	563 mm	586 mm	586 mm
Label Position ラベル位置	Y	Y	X		

Unit: mm / 単位: mm

SO type SO タイプ		SO4	SO6	SO8	SO16	
Magazine マガジン	Dimensions 断面形状					
	Quantities per Magazine 1 マガジン当りの詰め数	175 pcs	125 pcs	100 pcs	50 pcs	
Carton 包装箱	Number of Magazines 1 箱当りのマガジン数		40	40	24	40
	Carton Dimensions 包装箱寸法	A	71 mm	70 mm	75 mm	61 mm
		B	32 mm	55 mm	29 mm	56 mm
		C	584 mm	585 mm	579 mm	586 mm
Label Position ラベル位置		X	X	X	X	

Unit: mm / 単位: mm

SOL type SOL タイプ		SOL		
Magazine マガジン	Dimensions 断面形状			
	Pin Count ピンタイプ	6 (SO6L)	16 (SO16L)	
	Quantities per Magazine 1 マガジン当りの詰め数	125 pcs	50 pcs	
Carton 包装箱	Number of Magazines 1 箱当りのマガジン数		20	
	Carton Dimensions 包装箱寸法	A	70 mm	
		B	55 mm	
		C	585 mm	
Label Position ラベル位置		X		

* All dimensions are typical values.
* 寸法は標準値です。

Photocouplers are stored in magazines, and packed into cartons. An overview of how devices are packed is shown below.

フォトカプラはマガジンに収納され、その後、包装箱に収納されます。包装形態は以下の図の通りです。

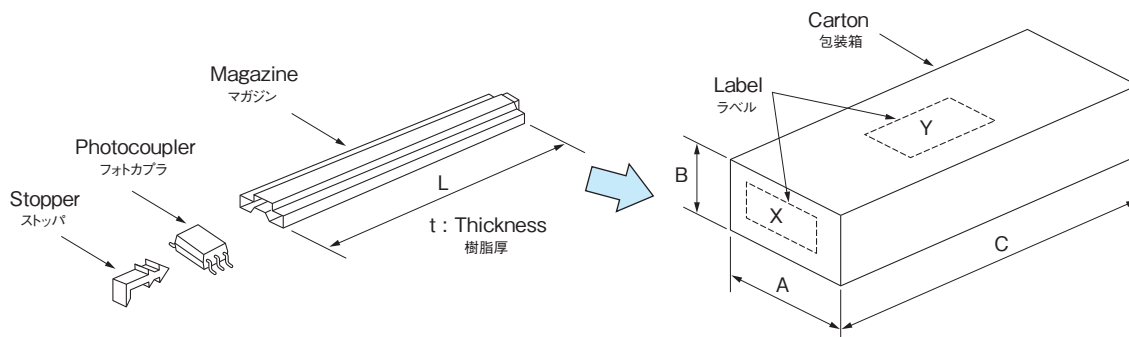

Tape-and-Reel Specification テーピング包装仕様

Tape Dimensions テープ形状および寸法

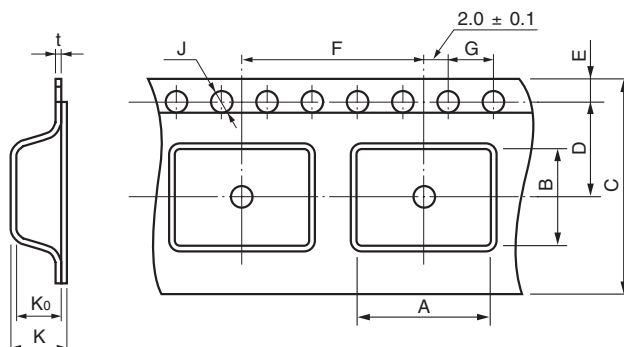

Unit: mm / 単位: mm

Package パッケージ	DIP (LF1) (LF5)	DIP (LF4)	SDIP6	SDIP6 F type	4pin / 5pin MFSOP6	2.54SOP4	2.54SOP6	2.54SOP8	SSOP4	USOP4	VSON4	SO4	4pin / 5pin SO6	SO8	SO16	4pin SO6L	SO6L	SO8L	SO16L		
Taping テーピング	(TP1) (TP5)	(TP4)	(TP)	(TP)	(TPL) (TPR)	(TP)	(TP)	(TP)	(TP)	(TP15)	(TP)	(TP)	(TPL) (TPR)	(TP)	(TP)	(TPL) (TPR)	(TP)	(TL)	(TP)		
Symbol 寸法記号	A	10.4 ± 0.1	12.3 ± 0.1	10.4 ± 0.1	12.3 ± 0.1	4.2 ± 0.1	4.3 ± 0.1	7.5 ± 0.1	2.35 ± 0.2	2.6 ± 0.1	1.6 ± 0.1	3.1 ± 0.1	4.0 ± 0.1	6.5 ± 0.1	7.5 ± 0.1	4.24 ± 0.1	10.4 ± 0.1	11.55 ± 0.1	10.4 ± 0.1		
	B	(*1)	(*1)	5.1 ± 0.1		7.6 ± 0.1	7.5 ± 0.1	6.7 ± 0.1	10.5 ± 0.1	4.5 ± 0.1	3.55 ± 0.1	3.0 ± 0.1	7.5 ± 0.1	7.6 ± 0.1	5.6 ± 0.1	10.5 ± 0.1	10.4 ± 0.1	4.24 ± 0.1	6.35 ± 0.1	10.7 ± 0.1	
	C	16.3 ± 0.3				12.0 ± 0.3	12.0 ± 0.3	16.0 ± 0.3	12.0 ± 0.3	12.0 ± 0.3	8.0 ± 0.3	12.0 ± 0.3		16.0 ± 0.3	16.0 ± 0.3	16.0 ± 0.3					
	D	7.5 ± 0.1				5.5 ± 0.1	5.5 ± 0.1	7.5 ± 0.1	5.5 ± 0.1	5.5 ± 0.1	3.5 ± 0.1	5.5 ± 0.1		7.5 ± 0.1	7.5 ± 0.1	7.5 ± 0.1					
	E	1.75 ± 0.1				1.75 ± 0.1	1.75 ± 0.1		1.75 ± 0.1		1.75 ± 0.1		1.75 ± 0.1		1.75 ± 0.1	1.75 ± 0.1					
	F	12.0 ± 0.1	16.0 ± 0.1	12.0 ± 0.1	16.0 ± 0.1	8.0 ± 0.1	8.0 ± 0.1	12.0 ± 0.1	4.0 ± 0.1	4.0 ± 0.1	4.0 ± 0.1	8.0 ± 0.1		12.0 ± 0.1	8.0 ± 0.1	12.0 ± 0.1	16.0 ± 0.1	12.0 ± 0.1	16.0 ± 0.1	12.0 ± 0.1	
	G	4.0 ± 0.1				4.0 ± 0.1	4.0 ± 0.1		4.0 ± 0.1		4.0 ± 0.1		4.0 ± 0.1		4.0 ± 0.1	4.0 ± 0.1					
	J	ø1.5 ^{+0.1} ₋₀				ø1.5 ^{+0.1} ₋₀	ø1.5 ^{+0.1} ₋₀		ø1.5 ^{+0.1} ₋₀		ø1.5 ^{+0.1} ₋₀		ø1.5 ^{+0.1} ₋₀		ø1.5 ^{+0.1} ₋₀	ø1.5 ^{+0.1} ₋₀					
	K	4.55 ± 0.2				3.15 ± 0.2	2.6 ± 0.2	2.5 ± 0.2	2.4 ± 0.2	2.4 ± 0.2	(2.0 ± 0.1)	(1.8 ± 0.1)	3.15 ± 0.2	2.9 ± 0.2	3.4 ± 0.2	2.6 ± 0.2	2.7 ± 0.1	(2.7 ± 0.1)	2.8 ± 0.1	(2.7 ± 0.1)	
	K0	4.1 ± 0.1				2.7 ± 0.1	2.4 ± 0.1	2.3 ± 0.1	2.2 ± 0.1	2.1 ± 0.1	1.95 ± 0.1	1.5 ± 0.1	2.3 ± 0.1	2.6 ± 0.1	3.1 ± 0.1	2.2 ± 0.1	2.4 ± 0.1	2.4 ± 0.1			
	t	0.4 ± 0.05				0.3 ± 0.05				0.3 ± 0.05	0.3 ± 0.1	0.2 ± 0.05	0.3 ± 0.05				0.3 ± 0.05	0.3 ± 0.05			

(*1): Typical devices 代表製品

DIP4	5.1 ± 0.1
DIP6 (short package)	7.6 ± 0.1
DIP8	10.1 ± 0.1 (TP4) is not available. (TP4)は対応不可。

Reel Dimensions リール形状および寸法

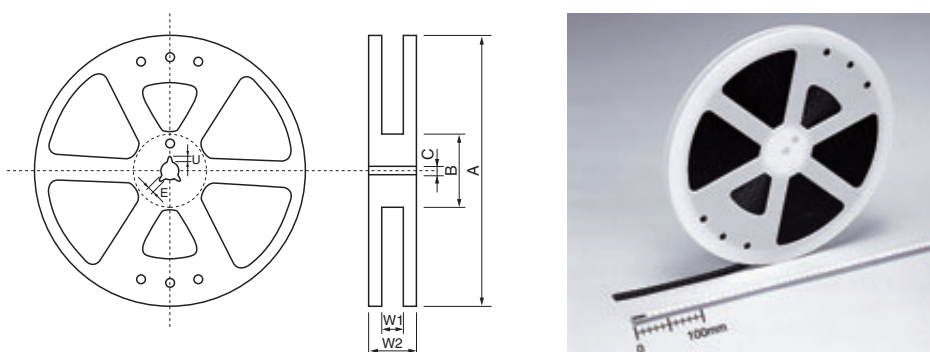

Unit: mm / 単位: mm

Package パッケージ	DIP (LF1) (LF5)	DIP (LF4)	SDIP6	SDIP6 F type	4pin / 5pin MFSOP6	2.54SOP4	2.54SOP6	2.54SOP8	SSOP4	USOP4	VSON4	SO4	4pin / 5pin SO6	SO8	SO16	4pin SO6L	SO6L	SO8L	SO16L
Taping テーピング	(TP1) (TP5)	(TP4)	(TP)	(TP)	(TPL) (TPR)	(TP)	(TP)	(TP)	(TP15)	(TP15)	(TP)	(TP)	(TPL) (TPR)	(TP)	(TP)	(TPL) (TPR)	(TP)	(TL)	(TP)
Symbol 寸法記号	A	380 ± 2			ø380 ± 2	ø330 ± 2			180 ⁺⁰ ₋₄	180 ⁺⁰ ₋₄	ø180 ± 3	ø330 ± 2			ø330 ± 2				
	B	ø80 ± 1				ø80 ± 1	ø80 ± 1		ø60	ø60	ø60 ± 1	ø80 ± 1			ø100 ± 1				
	C	ø13 ± 0.5				ø13 ± 0.5	ø13 ± 0.5		ø13	ø13 ± 0.5			ø13 ± 0.5			ø13 ± 0.5			
	E	2.0 ± 0.5				2.0 ± 0.5	2.0 ± 0.5		2.0 ± 0.5			2.0 ± 0.5			2.0 ± 0.5				
	U	4.0 ± 0.5				4.0 ± 0.5	4.0 ± 0.5		4.0 ± 0.5			4.0 ± 0.5			4.0 ± 0.5				
	W1	175 ± 0.5				13.5 ± 0.5	13.5 ± 0.5	17.5 ± 0.5	13.0 ± 0.3	13.0 ± 0.3	9.0 ± 0.3	13.5 ± 0.5			17.5 ± 0.5	17.4 ± 1.0			
	W2	21.5 ± 1.0				17.5 ± 1.0	17.5 ± 1.0	21.5 ± 1.0	15.4 ± 1.0	15.4 ± 1.0	11.4 ± 1.0	17.5 ± 1.0			21.5 ± 1.0	21.4 ± 1.0			

■ Device Orientation on Tape テーピング方向

Photocouplers are oriented in cavity, as shown below.

キャリアテープ凹み角穴内のフォトカプラの向きは、下記に示す通りです。

Package Type パッケージ分類	Tape Option テーピング名称	Packing Quantity 包装数量 (pcs/reel)	Device Orientation on Tape テーピング方向
VSON4	TP	3,000	
USOP4	TP15	1,500	
SSOP4			
2.54SOP4	TP	2,500	
SO4	TP, TPL / TPR	2,500	
4pin MFSOP6	TPL / TPR	3,000	
5pin MFSOP6			
4pin SO6			
5pin SO6			
4pin SO6L	TP	2,500	
2.54SOP6			
2.54SOP8			
SO6L			
SO8	TL	2,500	
SO8L		1,500	
SO16	TP	2,000	
SO16L		1,500	
SDIP6	TP1	1,500	
SDIP6 (F Type)		1,000	
DIP (LF1)		1,500	
DIP (LF4)	TP4	1,000	
DIP (LF5)	TP5	1,500	

■ Empty Device Recesses 製品封入不良率

Item 項目	Standard 規格	Remarks 備考
Occurrences of 2 or more successive empty device recesses. 連続した製品抜け	0	Within any given 40-mm section of tape, not including leader and trailer. リーダー、トレイラ部を除いたテープの任意の40mm以内
Single empty device recesses. 非連続の製品抜け	6 devices (max) per reel 最大6個 (1リール当たり)	Not including leader and trailer. リーダー、トレイラ部は除く

■ Packing Boxes 包装

Either one reel or ten reels of photocoupler are packed in a shipping carton.

1リールまたは10リール（最大）をダンボール箱に梱包します。

■ Label Format 包装表示

(1) Carton: The label provides the part number, quantity, lot number, the Toshiba logo, etc.

(2) Reel: The label provides the part number, the taping name, quantity, lot number, etc.

(1) 箱：品番・数量・ロット記号・当社名を表示します。

(2) リール：品番・テーピング名・数量・ロット記号を表示します。

The standard taping specification is presented herein. The taping specification and name for some products may be different. For details, see technical datasheets for individual products.

標準テーピング包装仕様を掲載しておりますが、製品によってはその仕様およびテーピング名称が異なる場合があります。

詳しくは各個別技術資料でご確認ください。

Board Assembly Considerations

1. Soldering

The profile below shows only the typical temperature profile and conditions, which might not apply to all Toshiba photocouplers. Temperature profiles and conditions may differ from product to product. Refer to the relevant technical datasheets when mounting a device.

When using a soldering iron or medium infrared ray / hot air reflow, avoid a rise in device temperature as much as possible by observing the following conditions.

1.1) Using a soldering iron

- Solder once within 10 seconds for a lead temperature of up to 260°C .
- Solder once within 3 seconds for a lead temperature of up to 350°C .

1.2) Using medium infrared ray/hot air reflow

- Complete the infrared ray/hot air reflow process at once within 30 seconds at a package surface temperature between 210°C and 240°C .
- Example of temperature profile of lead (Pb)-free solder

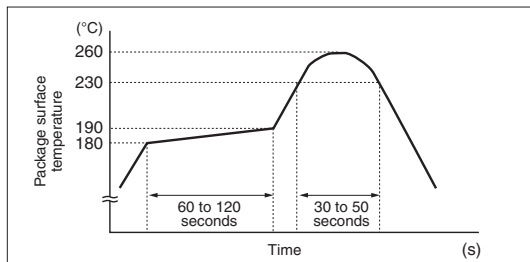

Example of temperature profile of lead (Pb)-free solder

c. Temperature Profile of JEDEC Pb-Free Solder (For Reference Only)

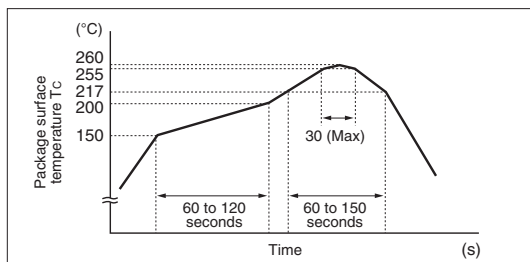

Temperature profile of JEDEC Pb-free solder (for reference only)

d. Precautions for heating

Keeping packages at high temperature for a long period of time can degrade the quality and reliability of devices.

Soldering time has to be kept as short as possible to avoid a rise in package temperature.

When using a halogen lamp or infrared heater, avoid direct irradiation of packages, since this may cause a rise in package temperature.

1.3) Dip soldering (flow soldering)

The thermal shock of dip soldering increases thermal stress on devices. To avoid stress, the use of a soldering iron or medium infrared ray/hot air reflow is recommended. If you want to use dip soldering, contact your nearest Toshiba sales representative.

実装上の留意点

(1) はんだ付け実装

下記すべての実装方法における温度プロファイル、条件は代表的なものです。個々の製品により異なる場合がありますので、個別の技術資料に記載されている条件をお客さまにてご確認の上、実装してください。

はんだ付けは、はんだごて法、リフロー法ともに、次の条件でできる限り本体の温度上昇を防いでください。

(1.1) はんだごて法の場合

リード部温度を 260°C、10 秒以内、1 回、または 350°C、3 秒以内、1 回で実施して下さい。

(1.2) はんだリフロー法の場合

- 樹脂部表面の雰囲気温度は 210°C 以上を 30 秒以内、1 回にて実施してください。また、樹脂部表面の雰囲気温度は最大 240°C としてください。

(b) 無鉛はんだの参考温度プロファイル

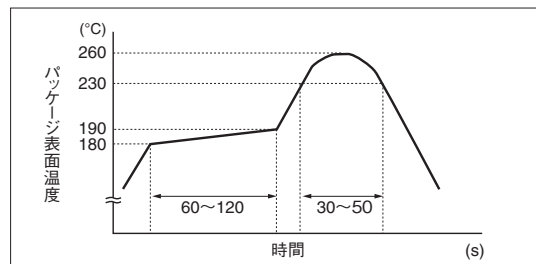

無鉛はんだの参考温度プロファイル

(c) JEDEC 無鉛はんだの参考温度プロファイル

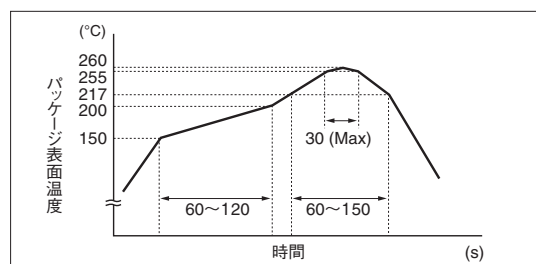

JEDEC 無鉛はんだの参考温度プロファイル

(d) 加熱方法についてのご注意

樹脂を高温に長時間放置すると、信頼性に悪影響をおよぼすことがあります。樹脂部の温度が上がらないように、できるだけ短時間にはんだ付けする必要があります。また、ハロゲンランプ、赤外線ヒータをご使用の場合は局部的な温度上昇を生じることがありますので、樹脂表面への直接照射は避けてください。

(1.3) はんだ浸漬法の場合

はんだ浸漬法では、はんだの熱容量が大きいため、素子に与える熱的ストレスが大きくなります。できるだけ、はんだごてやはんだリフロー法によるはんだ付けを実施してください。はんだ浸漬法をご検討の場合は、当社営業窓口にご相談ください。

2. Flux Cleaning

- When cleaning circuit boards to remove flux, make sure that no residual reactive ions such as sodium (Na+) or chloride (Cl-) ions remain. Note that organic solvents react with water to generate hydrogen chloride and other corrosive gases, which can degrade device performance.
- Washing devices with water will not cause any problems. However, make sure that no reactive ions such as sodium (Na+) or chloride (Cl-) ions are left as residue. Also, be sure to dry devices sufficiently after washing.
- Do not rub device markings with a brush or with your hand during cleaning or while the devices are still wet from the cleaning agent. Doing so can rub off the markings.
- Dip cleaning, shower cleaning and steam cleaning processes all involve the chemical action of a solvent. Use only recommended solvents for these cleaning methods. When immersing devices in a solvent or steam bath, make sure that the temperature of the liquid is 50°C or below and that the circuit board is removed from the bath within one minute.
- If a device package allows ultrasonic cleaning, keep the duration of ultrasonic cleaning as short as possible, since long hours of ultrasonic cleaning degrade the adhesion between the mold resin and the frame material.

■ The following ultrasonic cleaning conditions are recommended.

Frequency: 27 kHz to 29 kHz
Ultrasonic output power: 300 W or less (0.25 W/cm² or less)
Cleaning time: 30 seconds or less

Suspend the circuit board in the solvent bath during ultrasonic cleaning in such a way that the ultrasonic vibrator does not come into direct contact with the circuit board or the device. Conventional cleaning solvents that contain freon are not recommended due to its adverse effects on the earth's ozone layer. Alternative freon-free products are available on the market. Contact Toshiba or a Toshiba distributor regarding cleaning conditions and other relevant information for each product type.

(2) フラックス洗浄

- フラックス洗浄は、ナトリウム、塩素などの反応性イオンの残留がないように洗浄してください。有機溶剤によっては水と反応し、塩化水素などの腐食性ガスを発生させ、デバイスの劣化を生じさせる恐れがあります。
- 水洗浄に際しては、特にナトリウム、塩素などの反応性イオンが残渣として残らないように洗浄してください。また、乾燥は十分行ってください。
- 洗浄中、または洗浄液がデバイスに付着した状態で、ブラシや手で表示マーク面をこすらないでください。表示マークが消える恐れがあります。
- 浸漬洗浄、シャワー洗浄、およびスチーム洗浄は溶剤の化学的作用により洗浄を行います。溶剤中やスチーム中の浸漬時間は、デバイスへの影響を考慮して、液温 50°C 以下で 1 分以内に処理してください。
- 短時間で、洗浄効果の高い超音波による洗浄方法がありますが、長時間の超音波洗浄はモールド樹脂とフレーム材との密着性を低下させますので、最小限にしてください。

■ 推奨する基本的な条件を次に示します。

超音波洗浄の推奨条件

周波数: 27 ~ 29 kHz
超音波出力: 300 W 以下 (0.25 W/cm² 以下)
洗浄時間: 30 秒以下

超音波振動子とプリント基板やデバイスが、直接触れないように溶剤中に浮遊した状態で行ってください。

洗浄については、従来から使用されてきたフロン系洗浄剤はオゾン層破壊の問題で使用できなくなっており、これに代わる洗浄剤が市販されています。

なお、個別製品の洗浄条件など詳細については、当社営業窓口にお問い合わせください。

Device Degradation

使用上の留意点

Projected Operating Life Based on LED Light Output Degradation フォトカプラの推定寿命

Toshiba photocouplers use one of four types of LEDs and a projection of the operating life has been made for each LED. The table on page 59 shows the types of LED used in photocouplers and the figures on pages 60 to 63 show projections of long-term light output performance and operating life. Note that these operating life data are estimates extrapolated from long-term light output degradation over a single wafer lot and are shown as reference only.

当社のフォトカプラは、大きく分けて4種類のLEDを使用しており、寿命推定はLEDの種類ごとに実施しています。P.59に各カプラと使用しているLEDの対応表を示し、下表およびP.60～63に推定寿命パラメータを提示します。しかし、この結果は単一ロットの長期データからの推定であり、“参考データ”とお考えください。

	Projected Operating Life ⁽¹⁾ 推定寿命 ⁽¹⁾		Photocouplers フォトカプラの種類
	F50% operating life ⁽²⁾ F50% 寿命 ⁽²⁾	F0.1% operating life ⁽³⁾ F0.1% 寿命 ⁽³⁾	
① GaAs LED	1,300,000 h	260,000 h	Mainly for phototransistor output devices and phototriac output devices 主として、フォトトランジスタカプラ系、フォトトライアックカプラ
② GaAlAs (SH) LED	540,000 h	100,000 h	Mainly for photo-IC couplers 主として、フォト IC カプラ系
③ GaAlAs (DH) LED	1,000,000 h	200,000 h	Mainly for photorelays (MOSFET output), photovoltaic couplers and photo-IC couplers 主として、フォトリレー (MOSFET)、フォトボルカプラ系、フォト IC カプラ系
④ GaAlAs (MQW) LED	Ask your local Toshiba sales representative. 当社営業窓口までお問い合わせください。		Mainly for photo-IC couplers 主として、フォト IC カプラ系

- (1) Ta = 40°C, If = 20 mA, failure criteria: degradation rate ΔPo < -50%
 (2) Cumulative failure rate 50%: Time period until the projected long-term light output degradation curve of the average light output change (X̄) shown on pages 58 to 60 reaches the failure criteria.
 (3) Cumulative failure rate 0.1%: Time period until the projected long-term light output degradation curve of X̄ - 3σ shown on pages 58 to 60 reaches the failure criteria.

- (1) Ta = 40°C / If = 20 mA 時、障判定基準：劣化率 ΔPo < -50%
 (2) 累積故障確率 50% 寿命：P.58～60 に示す平均変動率 (X̄) の推定経時変化ラインが故障判定基準に達した時間とする。
 (3) 累積故障確率 0.1% 寿命：P.58～60 に示す X̄-3σ の推定経時変化ラインが故障判定基準に達した時間とする。

The relationship between LED light output degradation and optical coupling characteristics is shown below.

- The relationship between LED light output degradation and current transfer ratio (CTR)/short circuit current (Isc) is 1:1.

$$\frac{\text{CTR}(t)}{\text{CTR}(o)} = \frac{\text{Po}(t)}{\text{Po}(o)}$$

$$\frac{\text{CTR}(t)}{\text{CTR}(o)} = \frac{\text{Po}(t)}{\text{Po}(o)}$$

- The relationship between a reciprocal value of LED light output degradation and IFT/IFLH/IFHL/IFH change is 1:1.

$$\frac{I_{FT}(t)}{I_{FT}(o)} = \left(\frac{\text{Po}(t)}{\text{Po}(o)} \right)^{-1}$$

$$\frac{I_{FT}(t)}{I_{FT}(o)} = \left(\frac{\text{Po}(t)}{\text{Po}(o)} \right)^{-1}$$

LED 光出力劣化と各光結合特性劣化との相関については下記に示します。

- 変換効率 (CTR) および短絡電流 (Isc) は、LED の光出力劣化と 1 : 1 の相関があります。

- IFT / IFLH / IFHL / IFH の変動は、LED の光出力劣化の逆数と 1 : 1 の相関があります。

■ LEDs Used in Photocouplers フォトカプラと使用しているLEDの対応表

LED: ① GaAs ② GaAlAs (SH) ③ GaAlAs (DH) ④ GaAlAs (MQW)

Photocouplers フォトカプラ	LED	Photocouplers フォトカプラ	LED	Photocouplers フォトカプラ	LED	Photocouplers フォトカプラ	LED	Photorelays フォトリレー	LED
6N135	②	TLP2403	④	TLP352	④	TLP701A	④	TLP170 Series	①
6N136	②	TLP2404	④	TLP358	④	TLP701H	④	TLP171 Series	④
6N137	②	TLP2405	④	TLP358H	④	TLP705A	④	TLP172 Series	①
6N138	②	TLP2408	④	TLP360J	①	TLP708	④	TLP174G Series	①
6N139	②	TLP2409	④	TLP361J	①	TLP714	④	TLP175A	④
TLP104	④	TLP2418	④	TLP363J	①	TLP715	②	TLP176 Series	①
TLP109 Series	④	TLP2451A	④	TLP3782	④	TLP716	②	TLP179D	①
TLP116A	④	TLP2466	④	TLP3783	④	TLP718	②	TLP192 Series	①
TLP117	④	TLP2468	④	TLP383	④	TLP719	②	TLP197 Series	①
TLP118	④	TLP250H	④	TLP385	①	TLP731	①	TLP199D	①
TLP148G	①	TLP2530	②	TLP387	④	TLP732	①	TLP200D	①
TLP151A	④	TLP2531	②	TLP388	④	TLP748J	①	TLP202 Series	①
TLP152	④	TLP2601	②	TLP3902	①	TLP750	②	TLP206 Series	①
TLP155 Series	④	TLP2630	②	TLP3904	①	TLP751	②	TLP209D	①
TLP163J	①	TLP2631	②	TLP3905	④	TLP754	④	TLP222 Series	①
TLP182	④	TLP265J	④	TLP3906	④	TLP759 Series	②	TLP224G Series	①
TLP183	④	TLP2662	④	TLP3914	③	TLP762J	①	TLP225A	①
TLP184(SE)	①	TLP266J	④	TLP3924	③	TLP763J	①	TLP227 Series	①
TLP185(SE)	①	TLP267J	④	TLP512	②	TLP7820	④	TLP228 Series	①
TLP187	④	TLP268J	④	TLP525G Series	①	TLP7830	④	TLP240 Series	④
TLP188	④	TLP2701	④	TLP548J	①	TLP785	①	TLP241A	④
TLP190B	③	TLP2703	④	TLP549J	①	TLP7920	④	TLP592 Series	①
TLP191B	③	TLP2704	④	TLP550	②	TLP7930	④	TLP597 Series	①
TLP2066	③	TLP2710	④	TLP551	②	TLPN137	④	TLP598 Series	③
TLP2095	④	TLP2745	④	TLP552	②			TLP797 Series	①
TLP2098	④	TLP2748	④	TLP553	②			TLP798GA	③
TLP2105	②	TLP2761	④	TLP554	②			TLP31xx Series	①
TLP2108	②	TLP2766	④	TLP555	②			TLP3203	①
TLP2110	**	TLP2767	**	TLP557	②			TLP321x Series	①
TLP2116	②	TLP2768 Series	④	TLP558	②			TLP3220	①
TLP2118E	④	TLP290-4	①	TLP559 Series	②			TLP3230	①
TLP2160	④	TLP290(SE)	①	TLP560 Series	①			TLP3231	①
TLP2161	④	TLP291-4	①	TLP561 Series	①			TLP3240	③
TLP2166A	②	TLP291(SE)	①	TLP5701	④			TLP3241	③
TLP2167	**	TLP292 Series	④	TLP5702	④			TLP3250	③
TLP2168	④	TLP293 Series	④	TLP5751	④			TLP3275	①
TLP2200	②	TLP2955	④	TLP5752	④			TLP33xx Series	①
TLP2301	④	TLP2958	④	TLP5754	④			TLP34xx Series	④
TLP2303	④	TLP2962	④	TLP590B	③			TLP35xx Series	③
TLP2309	④	TLP3022(S)	①	TLP591B	③			TLP4xxx Series	①
TLP2310	**	TLP3023(S)	①	TLP5951	**				
TLP2345	**	TLP3042(S)	①	TLP5952	**				
TLP2348	**	TLP3043(S)	①	TLP5954	**				
TLP2355	④	TLP3052A	①	TLP627 Series	①				
TLP2358	④	TLP3062 Series	①	TLP651	②				
TLP2361	④	TLP3063(S)	①	TLP663J	①				
TLP2362	④	TLP3064(S)	③	TLP665 Series	①				
TLP2366	④	TLP3073	①	TLP666 Series	①				
TLP2367	**	TLP3082(S)	①	TLP668J	③				
TLP2368	④	TLP3083	①	TLP669L	④				
TLP2370	④	TLP350H	④	TLP700	④				
TLP2391	④	TLP351	②	TLP700A	④				
TLP2395	④	TLP351A	④	TLP700H	④				
TLP2398	④	TLP351H	④	TLP701	②				

** : Under development / 開発中

① GaAs LED

Projected Light Output Degradation Data 推定経時変化データ

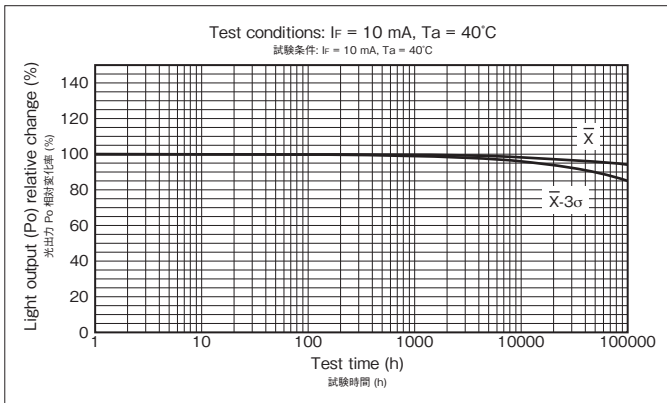
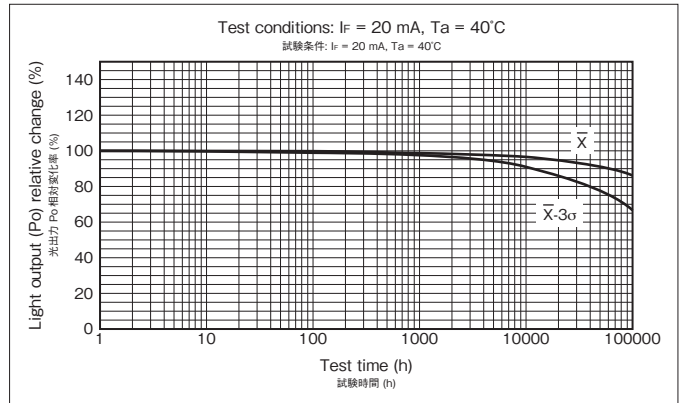
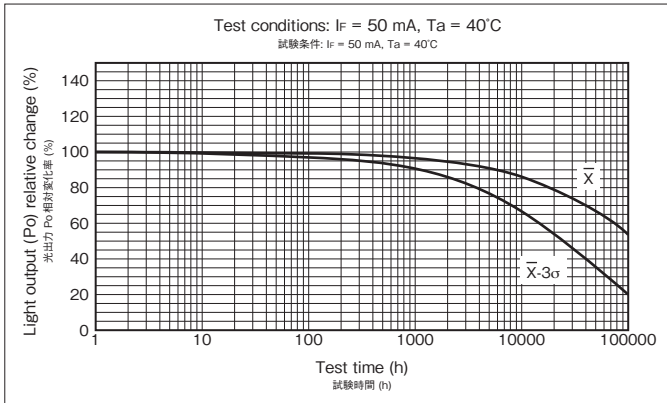

Projected Operating Life Data 推定寿命データ

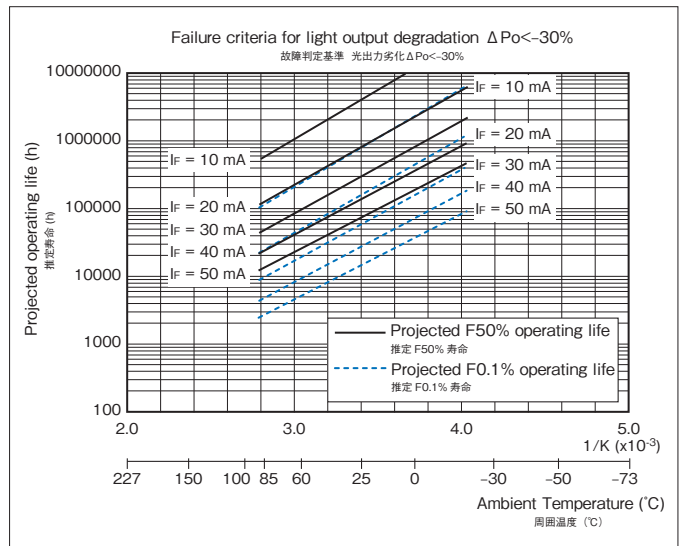
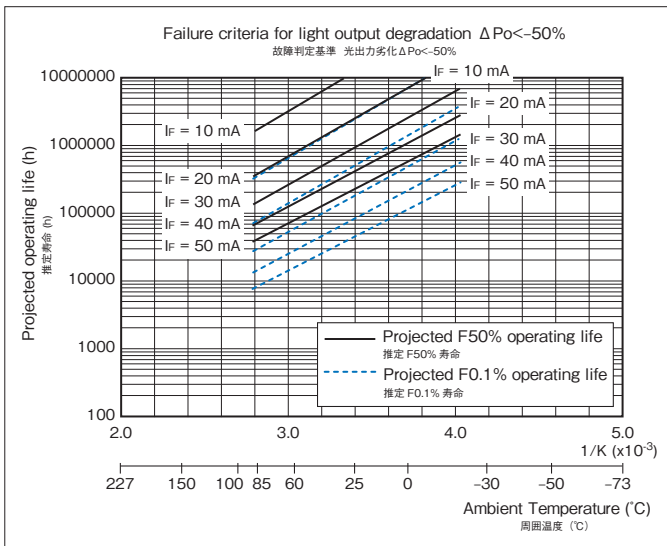

The above operating life data are estimates extrapolated from long-term light output degradation over a single wafer lot and are shown as reference only. Operating conditions exceeding the maximum ratings are not guaranteed.

上記推定寿命データは、LED 長期評価（単一ロット）をもとに寿命推定した参考データです。品種により定格を超える動作条件も含まれていますが、定格以外の動作については保証するものではありません。

② GaAlAs (SH) LED

Projected Light Output Degradation Data 推定経時変化データ

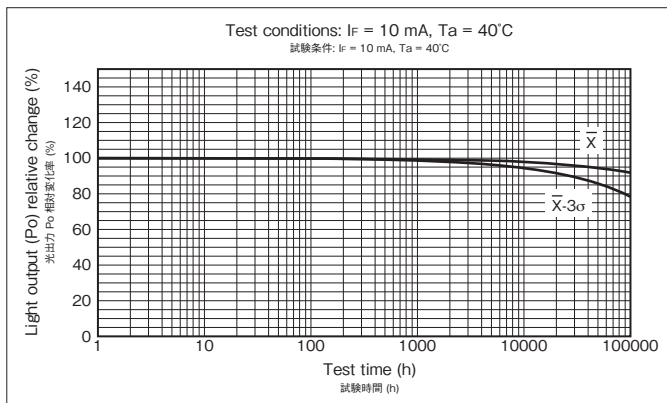
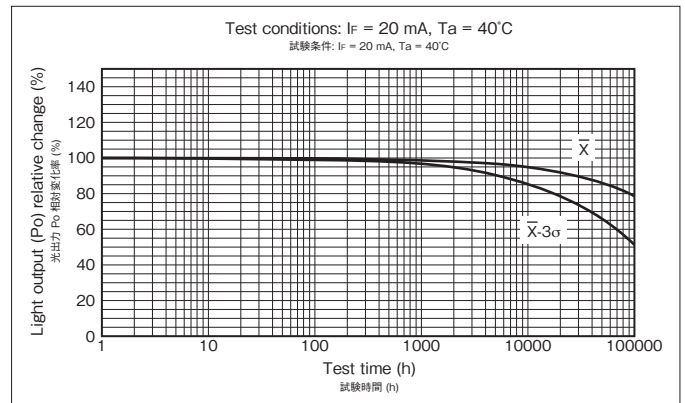
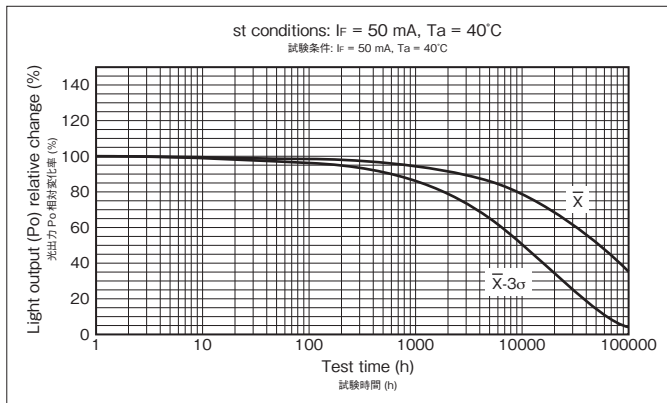

Projected Operating Life Data 推定寿命データ

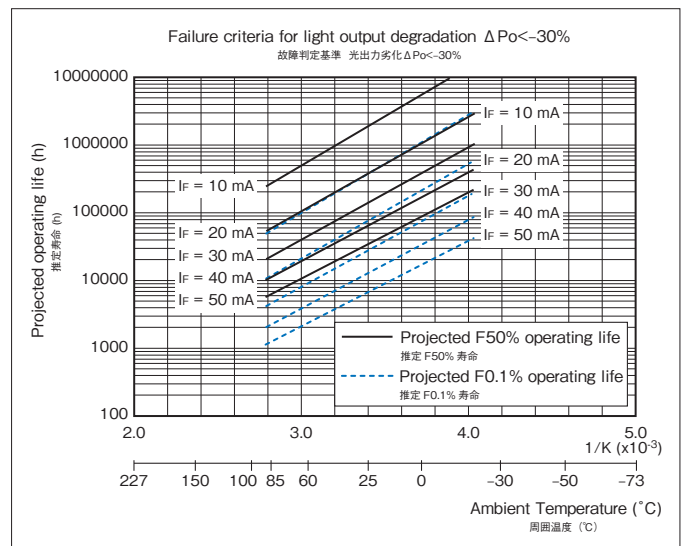
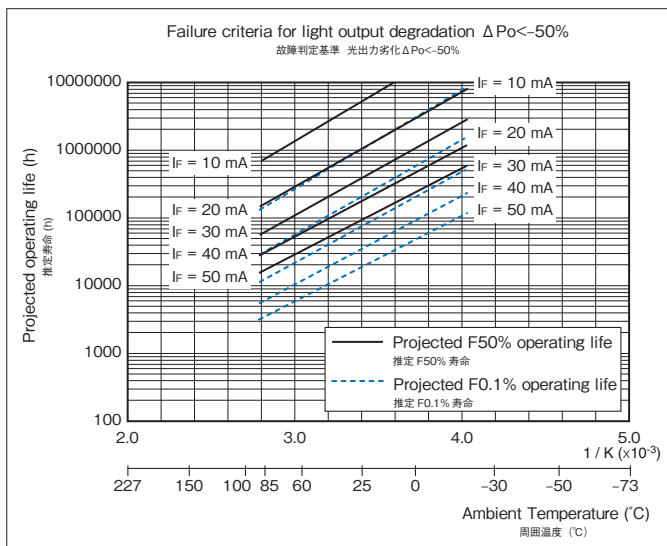

The above operating life data are estimates extrapolated from long-term light output degradation over a single wafer lot and are shown as reference only. Operating conditions exceeding the maximum ratings are not guaranteed.

上記推定寿命データは、LED 長期評価 (単一ロット) をもとに寿命推定した参考データです。品種により定格を超える動作条件も含まれていますが、定格以外の動作については保証するものではありません。

③ GaAlAs (DH) LED

Projected Light Output Degradation Data 推定経時変化データ

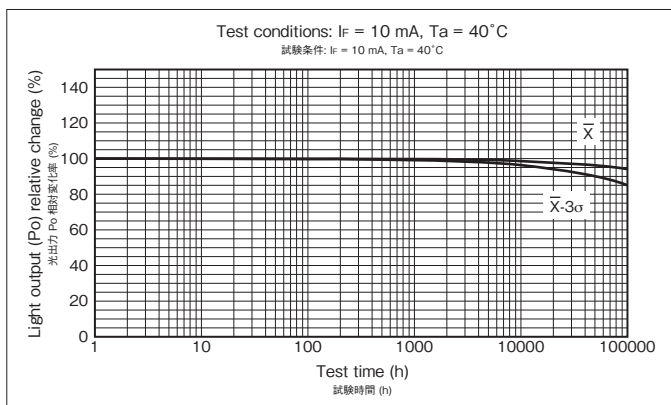
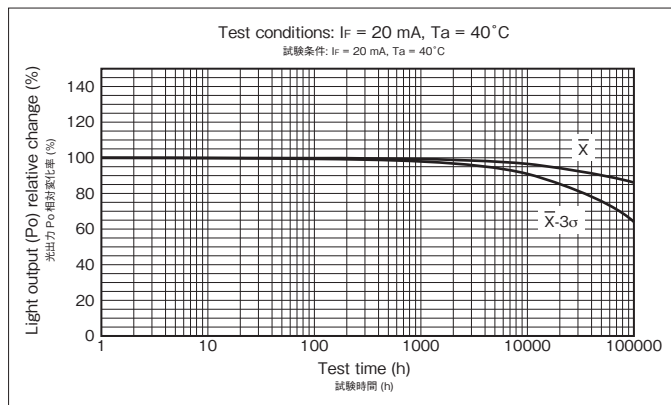
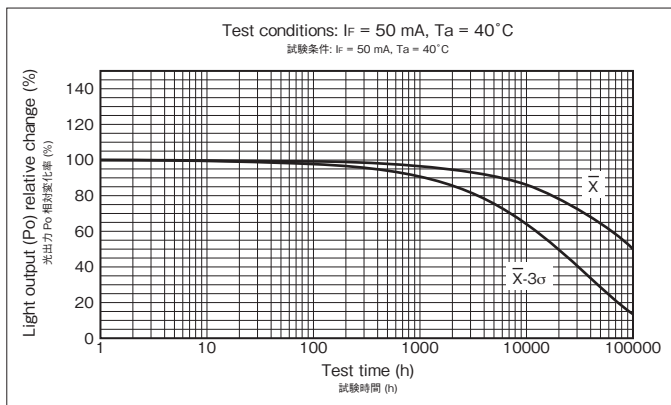

Projected Operating Life Data 推定寿命データ

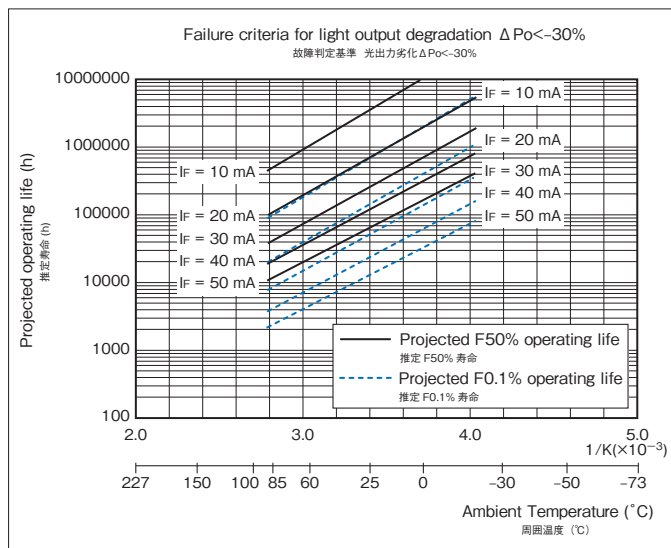
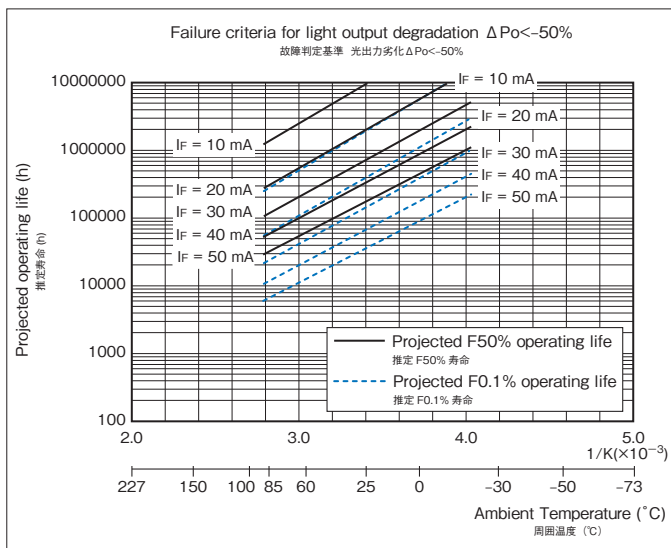

The above operating life data are estimates extrapolated from long-term light output degradation over a single wafer lot and are shown as reference only. Operating conditions exceeding the maximum ratings are not guaranteed.

上記推定寿命データは、LED 長期評価（単一ロット）をもとに寿命推定した参考データです。品種により定格を超える動作条件も含まれていますが、定格以外の動作については保証するものではありません。

④ GaAlAs (MQW) LED

Projected Light Output Degradation and Operating Life Data 推定経時変化データ / 推定寿命データ

Toshiba is now preparing the light output degradation and operating life data for GaAlAs (MQW) LEDs. These data are available for individual LEDs. Ask your local Toshiba sales representative.

製品カタログ掲載用データは、現在準備中です。

個別にデータのご用意が可能です。ご要求は、当社営業窓口までお問い合わせください。

Reading the Projected LED Operating Life Graph LED 推定寿命の読み取り方

For example, let's calculate the operating life of the GaAs LED, based on the data shown on page 58. Here is an example of how to read an operating life, assuming that the ambient temperature (T_a) is 40°C and that the failure criterion is a 30% decrease in light output. Suppose that the initial LED current, I_f , is 20 mA. Since the horizontal axis of the failure criteria graph is the reciprocal of absolute temperature, it is necessary to convert the ambient temperature (T_a) to the reciprocal of absolute temperature (T):

$$T = \frac{1}{T_a + 273.15} = \frac{1}{40 + 273.15} \doteq 3.19 \times 10^{-3}$$

The graph shows the projected lifetimes for F50% and F0.1% cumulative failure probabilities in solid and dashed lines respectively. Normally, it is recommended to use F0.1% lines. As $X = 3.19$, its intersection with the $I_f = 20$ mA line for F0.1% is approximately 80,000 hours. (This figure is for reference only.)

下例として、P.58 の GaAs LED 推定寿命データから推定寿命を読み取ります。周囲温度 (T_a) が 40°C で、LED の光出力が 30% 低下した時のカプラ出力特性を故障判定基準とした場合の推定寿命をグラフから読み取ります。LED 電流 (I_f) の初期値は、20 mA とします。

故障判定基準 (光出力劣化 $\Delta P_o < -30\%$) グラフの X 軸は絶対温度の逆数となっているため、周囲温度 (T_a) を絶対温度の逆数 (T) に変換します。

グラフには推定 F50% 寿命 (累積故障確率 50%: 実線) と推定 F0.1% 寿命 (累積故障確率 0.1%: 点線) の記載があります。通常は推定 F0.1% 寿命のご使用を推奨します。

X 軸 = 3.19 と $I_f = 20$ mA の点線 (推定 F0.1% 寿命) から、約 8 万時間の推定寿命 (参考値) であることが読み取れます。

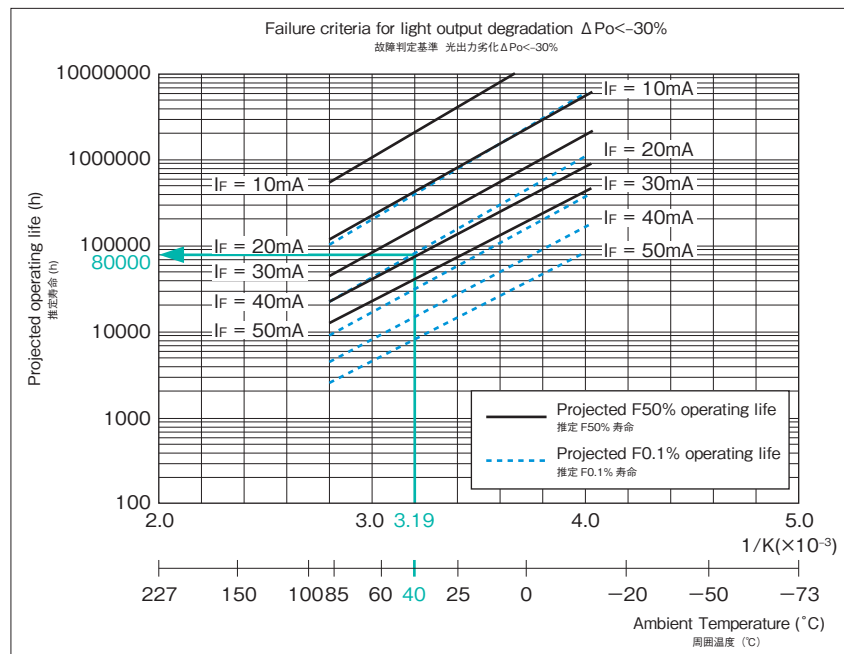

You can also estimate the projected operating life from the projected light output degradation data.

推定寿命は、LED 推定経時変化データグラフからも読み取ることができます。

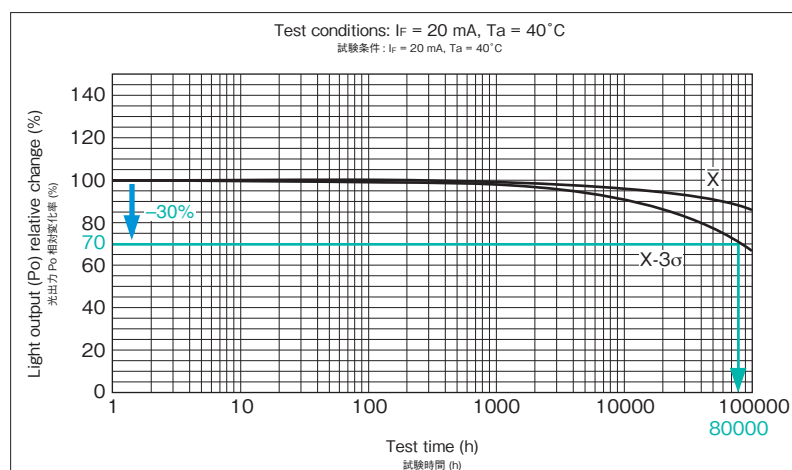

Safety Standard Approvals

海外安全規格認定

Toshiba offers a wide selection of photocouplers with a transistor output, IC output, thyristor output and triac output, as well as photorelays certified to UL (USA), c-UL (Canada), VDE (Germany), SEMKO (Sweden) and CQC (China).

UL (USA)、VDE (ドイツ)、SEMKO (スウェーデン)、および CQC (中国) の認定品をトランジスタ出力、IC 出力、サイリスタ出力、トライアック出力、フォトリレーの種々の品種にわたりラインアップしています。

The table above lists photocouplers and photorelays that have already been approved as of October 2015.

The information herein is subject to change. For the latest information, please contact your nearest Toshiba sales representative.

本表は、2015年10月現在の認定取得済み、取得予定製品です。取得内容が変更となる場合がございますので、最新情報を営業窓口にてご確認ください。また、認定書、内部構造図のご要求も営業窓口にご確認ください。

■ Safety Standard Approvals for Photocouplers (DIN EN60747-5-5) 安全規格認定品リスト

Mechanical Construction 構造	Transmissive Photocouplers in Single-Molded Packages 対向型シングルモールドパッケージ					Transmissive Photocouplers with an Insulating Film in Single-Molded Packages フィルム入り対向型シングルモールドパッケージ					Transmissive Photocouplers in Double-Molded Packages 対向型ダブルモールドパッケージ									
Internal Construction 内部構造																				
Package パッケージ	SO8 (2ch)	2.54SOP 4/6/8	DIP	DIP (F type)	SO8 (1 ch)	SDIP6	SDIP6 (F type)	DIP	DIP (F type)	MFSOP6	SO4	SO6	SO6L	SO8L	SO16	DIP	DIP (F type)			
Construction Mechanical Ratings (min) 構造パラメータ (最小)	Isolation Creepage Path (mm) 沿面距離	4.2	4.0	6.4/7.0	8.0	4.0	7.0	8.0	6.4/7.0	8.0	4.0	5.0	5.0	8.0	8.0	5.0	6.5/7.0	8.0		
	Isolation Clearance (mm) 空間距離	4.2	4.0	6.4/7.0	8.0	4.0	7.0	8.0	6.4/7.0	8.0	4.0	5.0	5.0	8.0	8.0	5.0	6.5/7.0	8.0		
	Isolation Thickness (mm) 絶縁物厚さ	—	—	(0.4)	(0.4)	—	0.4	0.4	0.4/0.5	0.4/0.5	—	0.4	0.4	0.4	0.4	—	0.4/0.5	0.4/0.5		
VDE/TÜV DIN EN 60747-5-5	Max Working Insulation Voltage (Viorm) 最大許容動作絶縁電圧	565 Vpk	565 Vpk	630 Vpk /890 Vpk	1140 Vpk	565 Vpk	890 Vpk	1140 Vpk	890 Vpk	1140 Vpk	565 Vpk	707 Vpk	707 Vpk	1140 Vpk /1230 Vpk	1230 Vpk	565 Vpk	890 Vpk /1130 Vpk	890 Vpk /1130 Vpk		
	Highest Allowable Overvoltage (Viotm) 最大許容過電圧	4000 Vpk	2500 Vpk	4000 Vpk	6000 Vpk	6000 Vpk	8000 Vpk	8000 Vpk	6000 Vpk /8000 Vpk	6000 Vpk /8000 Vpk	4000 Vpk /6000 Vpk	6000 Vpk	6000 Vpk	8000 Vpk	8000 Vpk	4000 Vpk	6000 Vpk /8000 Vpk	6000 Vpk /8000 Vpk		
Certified Devices 認定品種	IC Output IC 出力	TLP2105 TLP2108 TLP2166A TLP2116 TLP2118E TLP2168 TLP2160 TLP2161		TLP351 TLP559	TLP351F	TLP2403 TLP2404 TLP2405 TLP2408 TLP2409 TLP2418 TLP2451A TLP2466 TLP2468	TLP700 TLP700A TLP700H TLP701 TLP701A TLP701H TLP705A TLP708 TLP714 TLP715 TLP716 TLP718 TLP719 TLP2766 TLP2768	TLP700F TLP700AF TLP759 TLP759F TLP350H TLP351H TLP352F TLP358 TLP358F TLP358HF TLPN137 TLP250HF TLP250H TLP351AF TLP754F TLP2662F TLP2955F TLP2958F TLP2962F TLP7920F TLP7930F	TLP750 TLP750F TLP751 TLP751F TLP759F TLP350HF TLP351HF TLP352F TLP358 TLP358F TLP358HF TLPN137 TLP250HF TLP250H TLP351AF TLP754F TLP2662F TLP2955F TLP2958F TLP2962F TLP7920F TLP7930F		TLP117 TLP2066 TLP2095 TLP2098		TLP109 TLP116A TLP104 TLP118 TLP151A TLP152 TLP155 TLP155E TLP2309 TLP2310 TLP2345 TLP2348	TLP2355 TLP2358 TLP2362 TLP2366 TLP2368 TLP2370 TLP2301 TLP2303 TLP2361 TLP2391 TLP2395 TLP2398	TLP2703 TLP2704 TLP2710 TLP2745 TLP2748 TLP2761 TLP2768A TLP5701 TLP5702 TLP5751 TLP5752 TLP5754	TLP7820 TLP7830				
	Transistor Output トランジスタ出力								TLP627 TLP731 TLP732		TLP290(SE) TLP291(SE) TLP292 TLP293	TLP184(SE) TLP185(SE) TLP182 TLP183 TLP187 TLP188	TLP383 TLP385 TLP387		TLP290-4 TLP291-4 TLP292-4 TLP293-4	TLP785	TLP785F			
	Triac/Thyristor Output トライアック/ サイリスタ出力			TLP560G TLP560J TLP561G TLP561J					TLP360J TLP361J TLP363J TLP3022(S) TLP3023(S) TLP3042(S) TLP3043(S) TLP3062(S) TLP3063(S) TLP3064(S) TLP3082(S) TLP3782(S) TLP3783(S) TLP663J(S) TLP665G(S) TLP665J(S) TLP665L TLP666G(S) TLP666J(S) TLP666L(S) TLP668J(S) TLP669L(S)	TLP360JF TLP361JF TLP363JF TLP3022F(S) TLP3023F(S) TLP3042F(S) TLP3043F(S) TLP3062F(S) TLP3063F(S) TLP3064F(S) TLP3082F(S) TLP3782F(S) TLP3783F(S) TLP663JF(S) TLP665GF(S) TLP665JF(S) TLP665L TLP666GF(S) TLP666JF(S) TLP666LF(S) TLP668JF(S) TLP669LF(S)		TLP265J TLP266J TLP267J TLP268J				TLP762J TLP763J TLP748J	TLP762JF TLP763JF TLP748JF			
	Photorelay/ Photovoltaic フォトリレー/ フォトル出力		TLP170A TLP170D TLP170G TLP170J TLP171A TLP171D TLP171GA TLP171J TLP172A TLP172G TLP176A TLP176D TLP176G	TLP176GA TLP202G TLP206G TLP206GA TLP3114 TLP3115 TLP3116 TLP3118 TLP3119 TLP3121 TLP3122 TLP3123	TLP227G TLP227G-2 TLP597G				TLP797GA TLP797J	TLP797GAF TLP797JF			TLP175A TLP3905 TLP3906				TLP240A TLP240D TLP240G TLP240GA TLP240J TLP241A	TLP240AF TLP240DF TLP240GF TLP240GAF TLP240JF TLP241AF		

Cross Reference

他社製品との互換表

Isolation Amplifier アイソレーションアンプ

Manufacturer メーカー名	Manufacturer Part Number 他社品番	Toshiba Part Number 東芝互換製品	Compatible Level 互換レベル	Package パッケージ	Page ページ
Avago	ACPL-7900	TLP7920	A	DIP8	6
	ACPL-790A	TLP7920	A	DIP8	6
	ACPL-790B	TLP7920	A	DIP8	6
	ACPL-796J	TLP7830	B	SO8L	6
	ACPL-7970	TLP7930	A	DIP8	6
	ACPL-798J	TLP7830	B	SO8L	6
	ACPL-C780	TLP7820	A	SO8L	6
	ACPL-C784	TLP7820	A	SO8L	6
	ACPL-C78A	TLP7820	A	SO8L	6
	ACPL-C790	TLP7820	A	SO8L	6
	ACPL-C797	TLP7830	A	SO8L	6
	ACPL-C79A	TLP7820	A	SO8L	6
	ACPL-C79B	TLP7820	A	SO8L	6
	ACPL-C870	TLP7820	B	SO8L	6
	ACPL-C87A	TLP7820	B	SO8L	6
	ACPL-C87B	TLP7820	B	SO8L	6
	HCPL-7800	TLP7920	A	DIP8	6
	HCPL-7800A	TLP7920	A	DIP8	6
	HCPL-7840	TLP7920	A	DIP8	6
	HCPL-7860	TLP7930	A	DIP8	6
	HCPL-786J	TLP7830	B	SO8L	6

Manufacturer メーカー名	Manufacturer Part Number 他社品番	Toshiba Part Number 東芝互換製品	Compatible Level 互換レベル	Package パッケージ	Page ページ	
TI	AMC1100DWV	TLP7820	A	SO8L	6	
	AMC1100DUB	TLP7920	A	DIP8	6	
	AMC1200BDUB	TLP7920	A	DIP8	6	
	AMC1200BDWV	TLP7820	A	SO8L	6	
	AMC1203BDUB	TLP7930	A	DIP8	6	
	AMC1203BDW	TLP7830	B	SO8L	6	
	AMC1203BPSA	TLP7830	B	SO8L	6	
	AMC1203DUB	TLP7930	A	DIP8	6	
	AMC1203DW	TLP7830	B	SO8L	6	
	AMC1203PSA	TLP7830	B	SO8L	6	
	AMC1204BDW	TLP7830	B	SO8L	6	
	AMC1204BDWV	TLP7830	B	SO8L	6	
	AMC1204DW	TLP7830	B	SO8L	6	
	AMC1304	TLP7830	B	SO8L	6	
	AMC1305	TLP7830	B	SO8L	6	
	ADI	AD7400A	TLP7830	B	SO8L	6
		AD7401A	TLP7830	B	SO8L	6
AD7402		TLP7830	B	SO8L	6	
AD7403		TLP7830	B	SO8L	6	
AD7405		TLP7830	B	SO8L	6	
Renesas	PS8551A	TLP7920	A	DIP8	6	
	PS9551A	TLP7930	A	DIP8	6	

Compatible Level
S: Upper compatible
(Advantage of space or package)
A: Direct compatible
B: Close equivalent

互換レベル
S: 上位互換
(小型化実装面積優位)
A: 特性同等
B: 特性類似

IC Output IC 出力

IPM Drive IPM 駆動用

Manufacturer メーカー名	Manufacturer Part Number 他社品番	Toshiba Part Number 東芝互換製品	Compatible Level 互換レベル	Output Form 出力形態	Package パッケージ	Page ページ
Avago	ACPL-M483	TLP2348	A	(3)	5pin SO6	12
	ACPL-M484	TLP2345	A	(3)	5pin SO6	20
	ACPL-P454	TLP2704	B	(2)	SO6L	19
	ACPL-P456	TLP2704	B	(2)	SO6L	19
	ACPL-P480	TLP2710	B	(5)	SO6L	11
	ACPL-P481	TLP2710	B	(5)	SO6L	11
	ACPL-W454	TLP2704	B	(2)	SO6L	19
	ACPL-W456	TLP2704	B	(2)	SO6L	11
	ACPL-W480	TLP2710	B	(5)	SO6L	11
	ACPL-W481	TLP2710	B	(5)	SO6L	20
	HCPL-0201	TLP2405	A	(3)	SO8	20
	HCPL-0211	TLP2405	A	(3)	SO8	20
	HCPL-0452	TLP2409	A	(1)	SO8	9
	HCPL-0453	TLP2409	A	(1)	SO8	9
	HCPL-0454	TLP2404	S	(2)	SO8	19
	HCPL-0466	TLP2404	A	(2)	SO8	19
	HCPL-0500	TLP2409	B	(1)	SO8	9
	HCPL-0501	TLP2409	B	(1)	SO8	9
	HCPL-2200	TLP2955	B	(3)	DIP8	11
	HCPL-2201	TLP2955	A	(3)	DIP8	11
	HCPL-2202	TLP2955	B	(3)	DIP8	11
	HCPL-2211	TLP2955	B	(3)	DIP8	11

Manufacturer メーカー名	Manufacturer Part Number 他社品番	Toshiba Part Number 東芝互換製品	Compatible Level 互換レベル	Output Form 出力形態	Package パッケージ	Page ページ	
Avago	HCPL-2212	TLP2955	B	(3)	DIP8	11	
	HCPL-2219	TLP2955	B	(3)	DIP8	11	
	HCPL-4506	TLP754	B	(2)	DIP8	19	
	HCPL-M452	TLP2309	A	(1)	SO6	9	
	HCPL-M453	TLP2309	A	(1)	SO6	9	
	HCPL-M454	TLP2309	A	(1)	SO6	9	
	HCPL-M456	TLP104	A	(2)	SO6	19	
	Renesas	PS8101	TLP2309	A	(1)	SO6	9
		PS8302L	TLP2704	B	(2)	SO6L	19
		PS8701	TLP2309	A	(1)	SO6	9
PS8802-1		TLP2409	A	(1)	SO8	9	
PS8821		TLP2409	A	(1)	SO8	9	
PS9113		TLP104	A	(2)	5pin SO6	19	
PS9213		TLP104	A	(2)	5pin SO6	19	
PS9303		TLP2710	B	(5)	SO6L	11	
PS9313L		TLP2704	B	(2)	SO6L	19	
PS9513		TLP754	S	(2)	DIP8	19	
Sharp	PS9822-1	TLP2404	S	(2)	SO8	19	
	PC400T	TLP2303	B	(2)	SO6	8	
	PC456L	TLP104	S	(2)	5pin SO6	19	
	PC457L	TLP2309	A	(1)	SO6	9	
	PC457S	TLP2409	A	(1)	SO8	9	

High Speed Communications 高速通信用

Manufacturer メーカー名	Manufacturer Part Number 他社品番	Toshiba Part Number 東芝互換製品	Compatible Level 互換レベル	Output Form 出力形態	Package パッケージ	Page ページ
Avago	ACPL-071L	TLP2466	A	(3)	SO8	14
	ACPL-074L	TLP2160	A	(5)	SO8	14
	ACPL-M483	TLP2348	A	(3)	5pin SO6	20
	ACPL-M484	TLP2345	A	(3)	5pin SO6	20
	ACPL-M60L	TLP2368	A	(2)	5pin SO6	14
	ACPL-M61L	TLP2361	A	(2)	5pin SO6	13
	ACPL-M62L	TLP2368	B	(2)	5pin SO6	14
	ACPL-M75L	TLP2366	A	(3)	5pin SO6	14
	ACPL-P454	TLP2704	B	(2)	SO6L	19
	ACPL-P480	TLP2710	B	(3)	SO6L	11
	ACPL-P481	TLP2710	B	(3)	SO6L	11
	ACPL-P611	TLP2768A	B	(2)	SO6L	15
	ACPL-W454	TLP2704	B	(2)	SO6L	19
	ACPL-W480	TLP2710	B	(3)	SO6L	11
	ACPL-W481	TLP2710	B	(3)	SO6L	11
	ACPL-W60L	TLP2768A	B	(2)	SO6L	15
	ACPL-W611	TLP2768A	B	(2)	SO6L	15
	ACPL-W70L	TLP2770 **	B	(3)	SO6L	—
	HCPL-0201	TLP2405	A	(3)	SO8	11
	HCPL-0211	TLP2405	A	(3)	SO8	11
	HCPL-0452	TLP2409	A	(1)	SO8	9
	HCPL-0453	TLP2409	A	(1)	SO8	9
	HCPL-0454	TLP2404	B	(1)	SO8	20
	HCPL-0500	TLP2409	B	(1)	SO8	9
	HCPL-0501	TLP2409	B	(1)	SO8	9
	HCPL-0600	TLP2468	B	(2)	SO8	14
	HCPL-0601	TLP2468	B	(2)	SO8	14
	HCPL-060L	TLP2468	B	(2)	SO8	14
	HCPL-0611	TLP2468	B	(2)	SO8	14
	HCPL-061A	TLP2468	B	(2)	SO8	14
	HCPL-061N	TLP2468	B	(2)	SO8	14
	HCPL-0630	TLP2261 **	B	(5)	SO8L	—
	HCPL-0631	TLP2261 **	B	(5)	SO8L	—
	HCPL-063A	TLP2261 **	B	(5)	SO8L	—
	HCPL-063L	TLP2261 **	B	(5)	SO8L	—
	HCPL-063N	TLP2261 **	B	(5)	SO8L	—
	HCPL-0661	TLP2261 **	B	(5)	SO8L	—
	HCPL-0700	TLP2403	B	(1)	SO8	8
	HCPL-0701	TLP2403	B	(1)	SO8	8
	HCPL-070A	TLP2466	A	(3)	SO8	14
	HCPL-070A	TLP2403	B	(1)	SO8	8
	HCPL-070L	TLP2403	B	(1)	SO8	8
	HCPL-0738	TLP2168	B	(4)	SO8	14
	HCPL-2200	TLP2955	B	(3)	DIP8	11
	HCPL-2201	TLP2955	B	(3)	DIP8	11
	HCPL-2202	TLP2955	B	(3)	DIP8	11
	HCPL-2211	TLP2955	B	(3)	DIP8	11
HCPL-2212	TLP2955	B	(3)	DIP8	11	
HCPL-2219	TLP2955	B	(3)	DIP8	11	
HCPL-2231	TLP2105	B	(5)	SO8	10	
HCPL-2232	TLP2105	B	(5)	SO8	10	
HCPL-2601	TLPN137	B	(2)	DIP8	13	
HCPL-2611	TLPN137	B	(2)	DIP8	13	

Manufacturer メーカー名	Manufacturer Part Number 他社品番	Toshiba Part Number 東芝互換製品	Compatible Level 互換レベル	Output Form 出力形態	Package パッケージ	Page ページ	
Avago	HCPL-2630	TLP2662	A	(4)	DIP8	12	
	HCPL-2631	TLP2662	A	(4)	DIP8	12	
	HCPL-4502	TLP759	A	(1)	DIP8	20	
	HCPL-4503	TLP759	A	(1)	DIP8	20	
	HCPL-4504	TLP759	B	(1)	DIP8	20	
	HCPL-4506	TLP754	B	(2)	DIP8	19	
	HCPL-4661	TLP2662	A	(4)	DIP8	12	
	HCPL-M452	TLP2309	A	(1)	5pin SO6	9	
	HCPL-M453	TLP2309	A	(1)	5pin SO6	9	
	HCPL-M454	TLP2309	A	(1)	5pin SO6	9	
	HCPL-M456	TLP104	A	(2)	5pin SO6	19	
	HCPL-M600	TLP2362	A	(2)	5pin SO6	12	
	HCPL-M601	TLP2362	A	(2)	5pin SO6	12	
	HCPL-M611	TLP2362	A	(2)	5pin SO6	12	
	Renesas	PS8101	TLP2309	A	(1)	5pin SO6	9
		PS8302L	TLP2704	B	(2)	SO6L	19
		PS8501	TLP759	B	(1)	DIP8	20
		PS8502	TLP759	A	(1)	DIP8	20
		PS8601	TLP759	B	(1)	DIP8	20
		PS8602	TLP759	A	(1)	DIP8	20
PS8701		TLP2309	A	(1)	5pin SO6	9	
PS8802-1		TLP2409	A	(1)	SO8	9	
PS8802-2		TLP2108	B	(9)	SO8	10	
PS8821		TLP2409	A	(1)	SO8	9	
PS9115		TLP2361	S	(4)	SO6	13	
PS9117A		TLP2361	S	(4)	SO6	13	
PS9121		TLP2368	S	(2)	5pin SO6	14	
PS9122		TLP2362	S	(2)	SO6	12	
PS9123		TLP2366	S	(4)	SO6	14	
PS9124		TLP2362	S	(2)	SO6	12	
PS9151		TLP2366	S	(3)	5pin SO6	14	
PS9214		TLP2362	A	(2)	5pin SO6	12	
PS9303		TLP2710	B	(5)	SO6L	11	
PS9317L		TLP2768A	B	(2)	SO6L	15	
PS9324L		TLP2768A	B	(2)	SO6L	15	
PS9351L		TLP2761	B	(4)	SO6L	13	
PS9587		TLP2962	A	(2)	DIP8	12	
PS9617		TLP2962	A	(2)	DIP8	12	
PS9817A-1		TLP2468	S	(2)	SO8	14	
PS9817A-2		TLP2168	S	(4)	SO8	14	
PS9821-1		TLP2468	S	(2)	SO8	14	
PS9821-2		TLP2168	S	(4)	SO8	14	
PS9822-2	TLP2168	S	(4)	SO8	14		
PS9851-1	TLP2466	S	(3)	SO8	14		
PS9851-2	TLP2160	S	(5)	SO8	14		
Sharp	PC400T	TLP2303	B	(2)	SO6	8	
	PC410L	TLP2362	S	(2)	5pin SO6	12	
	PC410S	TLP2468	S	(2)	SO8	14	
	PC411S	TLP2466	S	(3)	SO8	14	
	PC457L	TLP2309	A	(1)	5pin SO6	9	
	PC457S	TLP2409	A	(1)	SO8	9	
PC4D10	TLP2168	A	(4)	SO8	14		

** : Under development / 開発中

Compatible Level

S: Upper compatible
(Advantage of space or package)

A: Direct compatible

B: Close equivalent

互換レベル

S : 上位互換
(小型化実装面積優位)

A : 特性同等

B : 特性類似

Output Form 出力形態

(1) Open collector (Analog output 1ch)	(2) Open collector (Digital output 1ch)	(3) Totem pole (1ch)	(4) Open collector (Digital output 2ch)	(5) Totem pole (2ch)

IGBT/MOSFET Gate Drive IGBT/MOSFET ゲート駆動用

Manufacturer メーカー名	Manufacturer Part Number 他社品番	Toshiba Part Number 東芝互換製品	Compatible Level 互換レベル	Package パッケージ	Page ページ
Avago	ACNW3130	TLPW3120 **	B	WDIP8	—
	ACNW3190	TLP358F	B	DIP8	17
	ACPL-3130	TLP352	B	DIP8	17
	ACPL-330J	TLP5214	B	SO16L	18
	ACPL-331J	TLP5214	S	SO16L	18
	ACPL-332J	TLP5214	S	SO16L	18
	ACPL-333J	TLP5214	B	SO16L	18
	ACPL-339J	TLP5214	B	SO16L	18
	ACPL-H312	TLP5702	B	SO6L	18
	ACPL-H342	TLP5752	B	SO6L	18
	ACPL-J313	TLP352	B	DIP8	17
	ACPL-K312	TLP5702	B	SO6L	18
	ACPL-K342	TLP5752	B	SO6L	18
	ACPL-P302	TLP5701	B	SO6L	18
	ACPL-P314	TLP5701	B	SO6L	18
	ACPL-P340	TLP5751	B	SO6L	18
	ACPL-P341	TLP5752	B	SO6L	18
	ACPL-P343	TLP5754	B	SO6L	18
	ACPL-P347	TLP5751	B	SO6L	18
	ACPL-P349	TLP5752	B	SO6L	18
	ACPL-T350	TLP352	A	DIP8	17
	ACPL-W302	TLP5701	B	SO6L	18
	ACPL-W314	TLP5701	B	SO6L	18
	ACPL-W340	TLP5751	B	SO6L	18
	ACPL-W341	TLP5752	B	SO6L	18
	ACPL-W343	TLP5754	B	SO6L	18
	ACPL-W347	TLP5751	B	SO6L	18
	ACPL-W349	TLP5752	B	SO6L	18
	HCNW3120	TLPW3120 **	A	WDIP8	—
	HCPL-0302	TLP2451A	A	SO8	18
	HCPL-0314	TLP2451A	A	SO8	18
	HCPL-3020	TLP351H	A	DIP8	17
	HCPL-3120	TLP352	B	DIP8	17
	HCPL-3140	TLP351H	A	DIP8	17
	HCPL-314J	TLP5701 x 2pcs	B	SO6L	18
	HCPL-3150	TLP351H	B	DIP8	17
	HCPL-315J	TLP5701 x 2pcs	B	SO6L	18

Manufacturer メーカー名	Manufacturer Part Number 他社品番	Toshiba Part Number 東芝互換製品	Compatible Level 互換レベル	Package パッケージ	Page ページ
Avago	HCPL-316J	TLP5214	B	SO16L	18
	HCPL-3180	TLP352	B	DIP8	17
	HCPL-J312	TLP352	B	DIP8	17
	HCPL-J314	TLP351H	B	DIP8	17
	HCPL-T250	TLP352	B	DIP8	17
Fairchild	FOD3120	TLP5752	B	SO6L	18
	FOD3150	TLP5751	B	SO6L	18
	FOD3182	TLP5754	S	SO6L	18
	FOD8314	TLP5702	S	SO6L	18
	FOD8332	TLP5214	S	SO16L	18
Renesas	PS9301	TLP5701	B	SO6L	18
	PS9302	TLP5702	B	SO6L	18
	PS9307L	TLP5701	B	SO6L	18
	PS9308L	TLP5702	B	SO6L	18
	PS9331L	TLP5702	B	SO6L	18
	PS9402	TLP5214	A	SO16L	18
	PS9505	TLP352	B	DIP8	17
	PS9506	TLP351H	A	DIP8	17
	PS9531	TLP352	B	DIP8	17
	PS9552	TLP350H	B	DIP8	16
Sharp	PC923	TLP2451A	A	SO8	18
	PC924	TLP351H	B	DIP8	17
	PC925	TLP352	B	DIP8	17
	PC928	TLP5214	B	SO16L	18
	PC929	TLP5214	B	SO16L	18

** : Under development / 開発中

Output

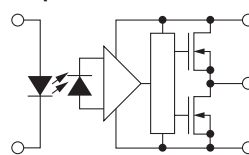

Photorelays フォトリレー

1-Form-A 1a 接点シリーズ

Manufacturer メーカー名	Manufacturer Part Number 他社品番	Toshiba Part Number 東芝互換製品	Compatible Level 互換レベル	Package パッケージ	Page ページ
Panasonic	AQV201	TLP241A	B	DIP4	39
	AQV202	TLP240A	B	DIP4	39
	AQV204	TLP240GA	B	DIP4	39
	AQV210EH	TLP240GA	B	DIP4	39
	AQV210S	TLP197G	A	2.54SOP6	37
	AQV212	TLP240A	B	DIP4	39
	AQV212S	TLP197A	B	2.54SOP6	37
	AQV214	TLP240GA	B	DIP4	39
	AQV214E	TLP240GA	B	DIP4	39
	AQV214EH	TLP240GA	B	DIP4	39
	AQV214H	TLP240GA	B	DIP4	39
	AQV214S	TLP197GA	B	2.54SOP6	37
	AQV215	TLP3546	S	DIP6	40
	AQV215S	TLP3105	S	2.54SOP6	38
	AQV216	TLP240J	B	DIP4	39
	AQV217S	TLP197D	A	2.54SOP6	37
	AQV227NS	TLP199D	A	2.54SOP6	37
	AQV251G	TLP3544	S	DIP6	40
	AQV252	TLP240A	B	DIP4	39
	AQV252G	TLP3545	S	DIP6	40
	AQV252G2S	TLP3107	S	2.54SOP6	38
	AQV254	TLP240GA	B	DIP4	39
	AQV254H	TLP240GA	B	DIP4	39
	AQV255	TLP3546	S	DIP6	40
	AQV255GS	TLP3105	S	2.54SOP6	38
	AQV210LS	TLP174G	A	2.54SOP4	36

Manufacturer メーカー名	Manufacturer Part Number 他社品番	Toshiba Part Number 東芝互換製品	Compatible Level 互換レベル	Package パッケージ	Page ページ
Panasonic	AQY211EH	TLP241A	S	DIP4	39
	AQY212GS	TLP3122	A	2.54SOP4	36
	AQY214EH	TLP240GA	A	DIP4	39
	AQY214S	TLP176GA	A	2.54SOP4	36
	AQY216EH	TLP240J	S	DIP4	39
	AQY221N2S	TLP3116	A	2.54SOP4	36
	AQY221N2VW	TLP3216	A	SSOP4	35
	AQY221R2S	TLP3115	S	2.54SOP4	36
	AQY221R2VW	TLP3214	A	SSOP4	34
	AQY222R2VW	TLP3212	A	SSOP4	34
	AQY225R1S	TLP3121	A	2.54SOP4	—
	AQY225R2S	TLP3119	A	2.54SOP4	36
	AQY225R2VW	TLP3217	A	SSOP4	35
IXYS	AQY234S	TLP171GA	A	2.54SOP4	36
	CPC1330	TLP240GA	A	DIP4	39
	CPC1393	TLP240J	A	DIP4	39
Renesas	LCA100	TLP240GA	B	DIP4	39
	PS7113-1A	TLP3546	S	DIP6	40
	PS7141E-1A	TLP240GA	B	DIP4	39
	PS7160-1A	TLP240J	B	DIP4	39
	PS7206-1A	TLP3122	S	2.54SOP4	36
	PS7241E-1A	TLP176GA	A	2.54SOP4	36
	PS7341-1A	TLP240GA	B	DIP4	39
	PS7360-1A	TLP240J	B	DIP4	39
	PS7804-1A	TLP3212	A	SSOP4	34

2-Form-A 2a 接点シリーズ

Manufacturer メーカー名	Manufacturer Part Number 他社品番	Toshiba Part Number 東芝互換製品	Compatible Level 互換レベル	Package パッケージ	Page ページ
Panasonic	AQW210	TLP222G-2	A	DIP8	41
		TLP240GA x 2pcs	B	DIP4	39
	AQW210EH	TLP240GA x 2pcs	B	DIP4	39
	AQW210HL	TLP224G-2	A	DIP8	41
	AQW210S	TLP206G	A	2.54SOP8	38
	AQW212	TLP222A-2	A	DIP8	41
		TLP240A x 2pcs	B	DIP4	39
	AQW212EH	TLP240GA x 2pcs	B	DIP4	39
	AQW212S	TLP202A	A	2.54SOP8	38
	AQW214	TLP227GA-2	A	DIP8	41
		TLP240GA x 2pcs	B	DIP4	39
	AQW214EH	TLP240GA x 2pcs	B	DIP4	39
	AQW214S	TLP206GA	A	2.54SOP8	38
	AQW215	TLP240D x 2pcs	B	DIP4	39
	AQW216	TLP240J x 2pcs	B	DIP4	39
	AQW216EH	TLP240J x 2pcs	B	DIP4	39
	AQW217	TLP240D x 2pcs	B	DIP4	39
	AQW223R2S	TLP222G-2	B	DIP8	41
		TLP240D x 2pcs	B	DIP4	39
	AQW224N	TLP227GA-2	B	DIP8	41
	AQW227N	TLP240GA x 2pcs	B	DIP4	39
		TLP240D x 2pcs	B	DIP4	39
	AQW227NS	TLP209D	A	2.54SOP8	—
	AQW254	TLP227GA-2	A	DIP8	41
TLP240GA x 2pcs		B	DIP4	39	
IXYS	CPC2014N	TLP202A	B	2.54SOP8	38
	CPC2017N	TLP202A	B	2.54SOP8	38
	CPC2025N	TLP206GA	B	2.54SOP8	38
	CPC2030N	TLP206G	B	2.54SOP8	38
Renesas	PS7241-2A	TLP206GA	A	2.54SOP8	38

2-Form-B 2b 接点シリーズ

Manufacturer メーカー名	Manufacturer Part Number 他社品番	Toshiba Part Number 東芝互換製品	Compatible Level 互換レベル	Package パッケージ	Page ページ
Panasonic	AQW414	TLP4227G-2	B	DIP8	42
	AQW414EH	TLP4227G-2	B	DIP8	42
	AQW414S	TLP4206G	B	2.54SOP8	42
	AQW454	TLP4227G-2	B	DIP8	42
IXYS	CPC2125N	TLP4206G	B	2.54SOP8	42
	LBB110	TLP4227G-2	B	DIP8	42
	PBB190	TLP4227G-2	B	DIP8	42
	XBB170	TLP4227G-2	A	DIP8	42

Compatible Level
S: Upper compatible
(Advantage of space or package)
A: Direct compatible
B: Close equivalent

互換レベル
S: 上位互換
(小型化実装面積優位)
A: 特性同等
B: 特性類似

1-Form-B 1b 接点シリーズ

Manufacturer メーカー名	Manufacturer Part Number 他社品番	Toshiba Part Number 東芝互換製品	Compatible Level 互換レベル	Package パッケージ	Page ページ	
Panasonic	AQV410EH	TLP4597G	B	DIP6	42	
	AQV414	TLP4597G	B	DIP6	42	
	AQV414E	TLP4597G	B	DIP6	42	
	AQV414S	TLP4197G	B	2.54SOP6	42	
	AQV454	TLP4597G	B	DIP6	42	
	AQV454H	TLP4597G	B	DIP6	42	
	AQY410EH	TLP4227G	B	DIP4	42	
	AQY410S	TLP4176G	A	2.54SOP4	42	
	AQY414EH	TLP4227G	B	DIP4	42	
	AQY414S	TLP4176G	B	2.54SOP4	42	
	IXYS	CPC1125N	TLP4176G	B	2.54SOP4	42
		CPC1130N	TLP4176G	A	2.54SOP4	42
		CPC1135N	TLP4176G	A	2.54SOP4	42
		CPC1150N	TLP4176G	A	2.65SOP4	42
CPC1231N		TLP4176G	A	2.54SOP4	42	
CPC1333		TLP4227G	A	DIP4	42	
LCB110		TLP4597G	B	DIP6	42	
LCB111		TLP4597G	B	DIP6	42	
PLB190		TLP4597G	B	DIP6	42	
XCB170		TLP4597G	A	DIP6	42	

1-Form-A/1-Form-B 1a/1b 接点シリーズ

Manufacturer メーカー名	Manufacturer Part Number 他社品番	Toshiba Part Number 東芝互換製品	Compatible Level 互換レベル	Package パッケージ	Page ページ
Panasonic	AQW610EH	TLP4006G	A	DIP8	42
	AQW610S	TLP4026G	B	2.54SOP8	42
	AQW614	TLP4006G	B	DIP8	42
	AQW614EH	TLP4006G	B	DIP8	42
	AQW654	TLP4006G	B	DIP8	42

- The information presented in this cross reference is based on TOSHIBA's selection criteria and should be treated as a suggestion only. Please carefully review the latest versions of all relevant information on the TOSHIBA products, including without limitation data sheets and validate all operating parameters of the TOSHIBA products to ensure that the suggested TOSHIBA products are truly compatible with your design and application.
- Please note that this cross reference is based on TOSHIBA's estimate of compatibility with other manufacturers' products, based on other manufacturers' published data, at the time the data was collected.
- TOSHIBA is not responsible for any incorrect or incomplete information. Information is subject to change at any time without notice.
- リスト中の製品名は参考です。製品に関する最新の情報をデータシート等でご確認の上、単独およびシステム全体で十分に評価し、お客様の責任において適用可否を判断してください。
- 参考にしている情報は、取得した時点の各メーカーの公式情報に基づいた当社の推定によるものです。
- 情報の正確性、完全性に関しての一切の保証はできません。また、情報は予告なく変更されることがあります。

Part Number Index

品番索引

Photocouplers フォトカプラ

Part Number 品番	Package パッケージ	Output 出力	Page ページ
TLP135	DIP8	IC	15
TLP136	DIP8	IC	15
TLP137	DIP8	IC	15
TLP138	DIP8	IC	15
TLP139	DIP8	IC	15
TLP104	5 pin SO6	IC	19
TLP109	5 pin SO6	IC	8
TLP109 (IGM)	5 pin SO6	IC	19
TLP116A	5 pin SO6	IC	14
TLP117	5 pin MFSOP6	IC	15
TLP118	5 pin SO6	IC	14
TLP148G	5 pin MFSOP6	Thyristor	29
TLP151A	5 pin SO6	IC	16
TLP152	5 pin SO6	IC	16
TLP155	5 pin SO6	IC	16
TLP155E	5 pin SO6	IC	16
TLP163J	4 pin MFSOP6 (cut)	Triac	26
TLP182	4 pin SO6	Transistor	24
TLP183	4 pin SO6	Transistor	22
TLP184 (SE)	4 pin SO6	Transistor	24
TLP185 (SE)	4 pin SO6	Transistor	22
TLP187	4 pin SO6	Transistor	24
TLP188	4 pin SO6	Transistor	22
TLP190B	4 pin MFSOP6	Photovoltaic	30
TLP191B	4 pin MFSOP6	Photovoltaic	30
TLP2066	5 pin MFSOP6	IC	14
TLP2095	5 pin MFSOP6	IC	10
TLP2098	5 pin MFSOP6	IC	10
TLP2105	SO8	IC	10
TLP2108	SO8	IC	10
TLP2110	SO8	IC	10
TLP2116	SO8	IC	13
TLP2118E	SO8	IC	13
TLP2160	SO8	IC	14
TLP2161	SO8	IC	13
TLP2166A	SO8	IC	13
TLP2167	SO8	IC	15
TLP2168	SO8	IC	14
TLP2200	DIP8	IC	10
TLP2301	4 pin SO6	IC	8
TLP2301	4 pin SO6	Transistor	23
TLP2303	5 pin SO6	IC	8
TLP2309	5 pin SO6	IC	9
TLP2310	5 pin SO6	IC	10
TLP2345	5 pin SO6	IC	11
TLP2345	5 pin SO6	IC	20
TLP2348	5 pin SO6	IC	12
TLP2348	5 pin SO6	IC	20
TLP2355	5 pin SO6	IC	10
TLP2355	5 pin SO6	IC	20
TLP2358	5 pin SO6	IC	11
TLP2358	5 pin SO6	IC	20
TLP2361	5 pin SO6	IC	13
TLP2362	5 pin SO6	IC	12
TLP2366	5 pin SO6	IC	14
TLP2367	5 pin SO6	IC	15
TLP2368	5 pin SO6	IC	14
TLP2370	5 pin SO6	IC	14
TLP2391	5 pin SO6	IC	12
TLP2395	5 pin SO6	IC	11
TLP2398	5 pin SO6	IC	11
TLP2403	SO8	IC	8
TLP2404	SO8	IC	20
TLP2405	SO8	IC	11
TLP2405	SO8	IC	20
TLP2408	SO8	IC	11
TLP2408	SO8	IC	20
TLP2409	SO8	IC	9
TLP2418	SO8	IC	14
TLP2451A	SO8	IC	18
TLP2466	SO8	IC	14
TLP2468	SO8	IC	14
TLP250H	DIP8	IC	16
TLP250HF	DIP8	IC	16
TLP2530	DIP8	IC	9
TLP2531	DIP8	IC	9
TLP2601	DIP8	IC	12
TLP2630	DIP8	IC	12
TLP2631	DIP8	IC	12
TLP265J	4 pin SO6	Triac	26
TLP2662	DIP8	IC	12
TLP2662F	DIP8	IC	12
TLP266J	4 pin SO6	Triac	26
TLP267J	4 pin SO6	Triac	26
TLP268J	4 pin SO6	Triac	27
TLP2701	4 pin SO6L	IC	8
TLP2701	4 pin SO6L	Transistor	23
TLP2703	SO6L	IC	8
TLP2704	SO6L	IC	19
TLP2710	SO6L	IC	11
TLP2745	SO6L	IC	12, 20
TLP2748	SO6L	IC	12, 20

Part Number 品番	Package パッケージ	Output 出力	Page ページ
TLP2761	SO6L	IC	13
TLP2766	SDIP6	IC	14
TLP2766F	SDIP6	IC	14
TLP2767	SO6L	IC	15
TLP2768	SDIP6	IC	15
TLP2768A	SO6L	IC	15
TLP2768F	SDIP6	IC	15
TLP290 (SE)	SO4	Transistor	24
TLP290-4	SO16	Transistor	24
TLP291 (SE)	SO4	Transistor	22
TLP291-4	SO16	Transistor	22
TLP292	SO4	Transistor	24
TLP292-4	SO16	Transistor	24
TLP293	SO4	Transistor	22
TLP293-4	SO16	Transistor	22
TLP2955	DIP8	IC	11, 21
TLP2955F	DIP8	IC	11, 21
TLP2958	DIP8	IC	11, 21
TLP2958F	DIP8	IC	11, 21
TLP2962	DIP8	IC	12
TLP2962F	DIP8	IC	12
TLP3022 (S)	5 pin DIP6 (cut)	Triac	26
TLP3022F (S)	5 pin DIP6 (cut)	Triac	26
TLP3023 (S)	5 pin DIP6 (cut)	Triac	26
TLP3023F (S)	5 pin DIP6 (cut)	Triac	26
TLP3042 (S)	5 pin DIP6 (cut)	Triac	26
TLP3042F (S)	5 pin DIP6 (cut)	Triac	26
TLP3043 (S)	5 pin DIP6 (cut)	Triac	26
TLP3043F (S)	5 pin DIP6 (cut)	Triac	26
TLP3052A	5 pin DIP6	Triac	27
TLP3062 (S)	5 pin DIP6 (cut)	Triac	27
TLP3062A	5 pin DIP6	Triac	27
TLP3062F (S)	5 pin DIP6 (cut)	Triac	27
TLP3063 (S)	5 pin DIP6 (cut)	Triac	27
TLP3063F (S)	5 pin DIP6 (cut)	Triac	27
TLP3064 (S)	5 pin DIP6 (cut)	Triac	27
TLP3064F (S)	5 pin DIP6 (cut)	Triac	27
TLP3073	5 pin DIP6	Triac	28
TLP3082 (S)	5 pin DIP6 (cut)	Triac	28
TLP3082F (S)	5 pin DIP6 (cut)	Triac	28
TLP3083	5 pin DIP6 (cut)	Triac	28
TLP350H	DIP8	IC	16
TLP350HF	DIP8	IC	16
TLP351	DIP8	IC	17
TLP351A	DIP8	IC	17
TLP351AF	DIP8	IC	17
TLP351F	DIP8	IC	17
TLP351H	DIP8	IC	17
TLP351HF	DIP8	IC	17
TLP352	DIP8	IC	17
TLP352F	DIP8	IC	17
TLP358	DIP8	IC	17
TLP358F	DIP8	IC	17
TLP358H	DIP8	IC	17
TLP358HF	DIP8	IC	17
TLP360J	DIP4	Triac	27
TLP360JF	DIP4	Triac	27
TLP361J	DIP4	Triac	27
TLP361JF	DIP4	Triac	27
TLP363J	DIP4	Triac	27
TLP363JF	DIP4	Triac	27
TLP3782 (S)	5 pin DIP6	Triac	28
TLP3782F (S)	5 pin DIP6	Triac	28
TLP3783 (S)	5 pin DIP6	Triac	28
TLP3783F (S)	5 pin DIP6	Triac	28
TLP383	4 pin SO6L	Transistor	23
TLP385	4 pin SO6L	Transistor	23
TLP387	4 pin SO6L	Transistor	24
TLP388	4 pin SO6L	Transistor	23
TLP3902	4 pin MFSOP6	Photovoltaic	30
TLP3904	SSOP4	Photovoltaic	30
TLP3905	4 pin SO6	Photovoltaic	30
TLP3906	4 pin SO6	Photovoltaic	30
TLP3914	SSOP4	Photovoltaic	30
TLP3924	SSOP4	Photovoltaic	30
TLP512	DIP6	IC	8
TLP5214	SO16L	IC	18
TLP525G	DIP4	Triac	26
TLP548J	DIP6	Thyristor	29
TLP549J	7 pin DIP8	Thyristor	29
TLP550	DIP8	IC	8
TLP551	DIP8	IC	9
TLP552	DIP8	IC	11
TLP553	DIP8	IC	8
TLP554	DIP8	IC	11
TLP555	DIP8	IC	10
TLP557	DIP8	IC	17
TLP558	DIP8	IC	10
TLP559	DIP8	IC	9
TLP559 (IGM)	DIP8	IC	19
TLP560G	5 pin DIP6 (cut)	Triac	26
TLP560J	5 pin DIP6 (cut)	Triac	27

Part Number 品番	Package パッケージ	Output 出力	Page ページ
TLP561G	5 pin DIP6 (cut)	Triac	26
TLP561J	5 pin DIP6 (cut)	Triac	27
TLP5701	SO6L	IC	18
TLP5702	SO6L	IC	18
TLP5751	SO6L	IC	18
TLP5752	SO6L	IC	18
TLP5754	SO6L	IC	18
TLP5771	SO6L	IC	18
TLP5772	SO6L	IC	18
TLP5774	SO6L	IC	18
TLP590B	5 pin DIP6 (cut)	Photovoltaic	30
TLP591B	5 pin DIP6 (cut)	Photovoltaic	30
TLP5951	DIP8	IC	18
TLP5952	DIP8	IC	18
TLP5954	DIP8	IC	18
TLP627	DIP4	Transistor	24
TLP651	DIP8	IC	9
TLP663J (S)	5 pin DIP6 (cut)	Triac	28
TLP663JF (S)	5 pin DIP6 (cut)	Triac	28
TLP665G (S)	5 pin DIP6 (cut)	Triac	28
TLP665GF (S)	5 pin DIP6 (cut)	Triac	28
TLP665J (S)	5 pin DIP6 (cut)	Triac	28
TLP665JF (S)	5 pin DIP6 (cut)	Triac	28
TLP665L	5 pin DIP6 (cut)	Triac	28
TLP666G (S)	5 pin DIP6 (cut)	Triac	28
TLP666GF (S)	5 pin DIP6 (cut)	Triac	28
TLP666J (S)	5 pin DIP6 (cut)	Triac	28
TLP666JF (S)	5 pin DIP6 (cut)	Triac	28
TLP666L (S)	5 pin DIP6 (cut)	Triac	28
TLP666LF (S)	5 pin DIP6 (cut)	Triac	28
TLP668J (S)	5 pin DIP6 (cut)	Triac	28
TLP668JF (S)	5 pin DIP6 (cut)	Triac	28
TLP669L (S)	5 pin DIP6	Triac	28
TLP669LF (S)	5 pin DIP6	Triac	28
TLP700	SDIP6	IC	17
TLP700A	SDIP6	IC	17
TLP700AF	SDIP6	IC	17
TLP700F	SDIP6	IC	17
TLP700H	SDIP6	IC	17
TLP700HF	SDIP6	IC	17
TLP701	SDIP6	IC	17
TLP701A	SDIP6	IC	17
TLP701AF	SDIP6	IC	17
TLP701F	SDIP6	IC	17
TLP701H	SDIP6	IC	18
TLP701HF	SDIP6	IC	18
TLP705A	SDIP6	IC	18
TLP705AF	SDIP6	IC	18
TLP708	SDIP6	IC	13
TLP708F	SDIP6	IC	13
TLP714	SDIP6	IC	19
TLP714F	SDIP6	IC	19
TLP715	SDIP6	IC	10
TLP715F	SDIP6	IC	10
TLP715F	SDIP6	IC	19
TLP716	SDIP6	IC	13
TLP716F	SDIP6	IC	13
TLP718	SDIP6	IC	10
TLP718	SDIP6	IC	19
TLP718F	SDIP6	IC	19
TLP719	SDIP6	IC	9, 20
TLP719F	SDIP6	IC	9, 20
TLP731	DIP6	Transistor	23
TLP732	DIP6	Transistor	23
TLP748J	DIP6	Thyristor	29
TLP748JF	DIP6	Thyristor	29
TLP750	DIP8	IC	9
TLP750F	DIP8	IC	9
TLP751	DIP8	IC	9
TLP751F	DIP8	IC	9
TLP754	DIP8	IC	19
TLP754F	DIP8	IC	19
TLP759	DIP8	IC	9
TLP759 (IGM)	DIP8	IC	20
TLP759F	DIP8	IC	9
TLP759F (IGM)	DIP8	IC	20
TLP762J	5 pin DIP6	Thyristor	27
TLP762JF	5 pin DIP6	Thyristor	27
TLP763J	5 pin DIP6	Triac	27
TLP763JF	5 pin DIP6	Triac	27
TLP7820	SO8L	Isolation Amplifier	6
TLP7830	SO8L	Isolation Amplifier	6
TLP785	DIP4	Transistor	23
TLP785F	DIP4	Transistor	23
TLP7920	DIP8	Isolation Amplifier	6
TLP7920F	DIP8	Isolation Amplifier	6
TLP7930	DIP8	Isolation Amplifier	6
TLP7930F	DIP8	Isolation Amplifier	6
TLPN137	DIP8	IC	13

Photorelays フォトリレー

Part Number 品番	Package パッケージ	Output / Contact Forms 出力 / Contact Forms	Page ページ
TLP170A	2.54SOP4	MOSFET / 1-Form-A	35
TLP170D	2.54SOP4	MOSFET / 1-Form-A	35
TLP170G	2.54SOP4	MOSFET / 1-Form-A	35
TLP170J	2.54SOP4	MOSFET / 1-Form-A	35
TLP171A	2.54SOP4	MOSFET / 1-Form-A	36
TLP171D	2.54SOP4	MOSFET / 1-Form-A	36
TLP171GA	2.54SOP4	MOSFET / 1-Form-A	36
TLP171J	2.54SOP4	MOSFET / 1-Form-A	36
TLP172A	2.54SOP4	MOSFET / 1-Form-A	36
TLP172G	2.54SOP4	MOSFET / 1-Form-A	36
TLP174G	2.54SOP4	MOSFET / 1-Form-A	36
TLP174GA	2.54SOP4	MOSFET / 1-Form-A	36
TLP175A	4 pin SO6	MOSFET / 1-Form-A	35
TLP176A	2.54SOP4	MOSFET / 1-Form-A	36
TLP176D	2.54SOP4	MOSFET / 1-Form-A	36
TLP176G	2.54SOP4	MOSFET / 1-Form-A	36
TLP176GA	2.54SOP4	MOSFET / 1-Form-A	36
TLP192A	2.54SOP6	MOSFET / 1-Form-A	37
TLP192G	2.54SOP6	MOSFET / 1-Form-A	37
TLP197A	2.54SOP6	MOSFET / 1-Form-A	37
TLP197D	2.54SOP6	MOSFET / 1-Form-A	37
TLP197G	2.54SOP6	MOSFET / 1-Form-A	37
TLP197GA	2.54SOP6	MOSFET / 1-Form-A	37
TLP200D	2.54SOP8	MOSFET / 1-Form-A	38
TLP202A	2.54SOP8	MOSFET / 1-Form-A	38
TLP202G	2.54SOP8	MOSFET / 1-Form-A	38
TLP206A	2.54SOP8	MOSFET / 1-Form-A	38
TLP206G	2.54SOP8	MOSFET / 1-Form-A	38
TLP206GA	2.54SOP8	MOSFET / 1-Form-A	38
TLP222A	DIP4	MOSFET / 1-Form-A	39
TLP222A-2	DIP8	MOSFET / 2-Form-A	41
TLP222D	DIP4	MOSFET / 1-Form-A	39
TLP222G	DIP4	MOSFET / 1-Form-A	39
TLP222G-2	DIP8	MOSFET / 2-Form-A	41
TLP224G	DIP4	MOSFET / 1-Form-A	39
TLP224G-2	DIP8	MOSFET / 2-Form-A	41
TLP224GA	DIP4	MOSFET / 1-Form-A	39
TLP224GA-2	DIP8	MOSFET / 2-Form-A	41
TLP225A	DIP4	MOSFET / 1-Form-A	39
TLP227A	DIP4	MOSFET / 1-Form-A	39
TLP227A-2	DIP8	MOSFET / 2-Form-A	41
TLP227G	DIP4	MOSFET / 1-Form-A	39
TLP227G-2	DIP8	MOSFET / 2-Form-A	41
TLP227GA	DIP4	MOSFET / 1-Form-A	39
TLP227GA-2	DIP8	MOSFET / 2-Form-A	41
TLP228G	DIP4	MOSFET / 1-Form-A	39
TLP228G-2	DIP8	MOSFET / 2-Form-A	41
TLP240A	DIP4	MOSFET / 1-Form-A	39
TLP240AF	DIP4	MOSFET / 1-Form-A	39
TLP240D	DIP4	MOSFET / 1-Form-A	39

Part Number 品番	Package パッケージ	Output / Contact Forms 出力 / Contact Forms	Page ページ
TLP240DF	DIP4	MOSFET / 1-Form-A	39
TLP240G	DIP4	MOSFET / 1-Form-A	39
TLP240GA	DIP4	MOSFET / 1-Form-A	39
TLP240GAF	DIP4	MOSFET / 1-Form-A	39
TLP240GF	DIP4	MOSFET / 1-Form-A	39
TLP240J	DIP4	MOSFET / 1-Form-A	39
TLP240JF	DIP4	MOSFET / 1-Form-A	39
TLP241A	DIP4	MOSFET / 1-Form-A	39
TLP241AF	DIP4	MOSFET / 1-Form-A	39
TLP3100	2.54SOP6	MOSFET / 1-Form-A	37
TLP3102	2.54SOP6	MOSFET / 1-Form-A	37
TLP3103	2.54SOP6	MOSFET / 1-Form-A	37
TLP3105	2.54SOP6	MOSFET / 1-Form-A	38
TLP3106	2.54SOP6	MOSFET / 1-Form-A	38
TLP3107	2.54SOP6	MOSFET / 1-Form-A	38
TLP3109	2.54SOP6	MOSFET / 1-Form-A	38
TLP3114	2.54SOP4	MOSFET / 1-Form-A	36
TLP3115	2.54SOP4	MOSFET / 1-Form-A	36
TLP3116	2.54SOP4	MOSFET / 1-Form-A	36
TLP3118	2.54SOP4	MOSFET / 1-Form-A	36
TLP3119	2.54SOP4	MOSFET / 1-Form-A	36
TLP3120	2.54SOP6	MOSFET / 1-Form-A	38
TLP3122	2.54SOP4	MOSFET / 1-Form-A	36
TLP3123	2.54SOP4	MOSFET / 1-Form-A	37
TLP3125	2.54SOP8	MOSFET / 1-Form-A	38
TLP3127	2.54SOP4	MOSFET / 1-Form-A	37
TLP3130	2.54SOP4	MOSFET / 1-Form-A	37
TLP3131	2.54SOP4	MOSFET / 1-Form-A	37
TLP3203	SSOP4	MOSFET / 1-Form-A	34
TLP3212	SSOP4	MOSFET / 1-Form-A	34
TLP3214	SSOP4	MOSFET / 1-Form-A	34
TLP3215	SSOP4	MOSFET / 1-Form-A	35
TLP3216	SSOP4	MOSFET / 1-Form-A	35
TLP3217	SSOP4	MOSFET / 1-Form-A	35
TLP3220	SSOP4	MOSFET / 1-Form-A	35
TLP3230	SSOP4	MOSFET / 1-Form-A	35
TLP3231	SSOP4	MOSFET / 1-Form-A	35
TLP3240	SSOP4	MOSFET / 1-Form-A	35
TLP3241	SSOP4	MOSFET / 1-Form-A	35
TLP3250	SSOP4	MOSFET / 1-Form-A	35
TLP3275	SSOP4	MOSFET / 1-Form-A	35
TLP3303	USOP4	MOSFET / 1-Form-A	33
TLP3306	USOP4	MOSFET / 1-Form-A	33
TLP3312	USOP4	MOSFET / 1-Form-A	33
TLP3315	USOP4	MOSFET / 1-Form-A	34
TLP3317	USOP4	MOSFET / 1-Form-A	34
TLP3319	USOP4	MOSFET / 1-Form-A	34
TLP3320	USOP4	MOSFET / 1-Form-A	34
TLP3330	USOP4	MOSFET / 1-Form-A	34
TLP3340	USOP4	MOSFET / 1-Form-A	34

Part Number 品番	Package パッケージ	Output / Contact Forms 出力 / Contact Forms	Page ページ
TLP3341	USOP4	MOSFET / 1-Form-A	34
TLP3342	USOP4	MOSFET / 1-Form-A	34
TLP3350	USOP4	MOSFET / 1-Form-A	34
TLP3351	USOP4	MOSFET / 1-Form-A	34
TLP3375	USOP4	MOSFET / 1-Form-A	34
TLP3403	VSON4	MOSFET / 1-Form-A	33
TLP3412	VSON4	MOSFET / 1-Form-A	33
TLP3417	VSON4	MOSFET / 1-Form-A	33
TLP3419	VSON4	MOSFET / 1-Form-A	33
TLP3420	VSON4	MOSFET / 1-Form-A	33
TLP3431	VSON4	MOSFET / 1-Form-A	33
TLP3440	VSON4	MOSFET / 1-Form-A	33
TLP3441	VSON4	MOSFET / 1-Form-A	33
TLP3442	VSON4	MOSFET / 1-Form-A	33
TLP3450	VSON4	MOSFET / 1-Form-A	33
TLP3451	VSON4	MOSFET / 1-Form-A	33
TLP3475	VSON4	MOSFET / 1-Form-A	33
TLP3542	DIP6	MOSFET / 1-Form-A	40
TLP3543	DIP6	MOSFET / 1-Form-A	40
TLP3544	DIP6	MOSFET / 1-Form-A	40
TLP3545	DIP6	MOSFET / 1-Form-A	40
TLP3546	DIP6	MOSFET / 1-Form-A	40
TLP3547	DIP8	MOSFET / 1-Form-A	41
TLP3548	DIP8	MOSFET / 1-Form-A	41
TLP3549	DIP8	MOSFET / 1-Form-A	41
TLP3553	DIP4	MOSFET / 1-Form-A	39
TLP3554	DIP4	MOSFET / 1-Form-A	39
TLP3555	DIP4	MOSFET / 1-Form-A	39
TLP3556	DIP4	MOSFET / 1-Form-A	39
TLP4006G	DIP8	MOSFET / 1-Form-A/B	42
TLP4026G	2.54SOP8	MOSFET / 1-Form-A/B	42
TLP4176G	2.54SOP4	MOSFET / 1-Form-B	42
TLP4197G	2.54SOP4	MOSFET / 1-Form-B	42
TLP4206G	2.54SOP8	MOSFET / 2-Form-B	42
TLP4227G	DIP4	MOSFET / 1-Form-B	42
TLP4227G-2	DIP8	MOSFET / 2-Form-B	42
TLP4597G	DIP6	MOSFET / 1-Form-B	42
TLP592A	DIP6	MOSFET / 1-Form-A	40
TLP592G	DIP6	MOSFET / 1-Form-A	40
TLP597A	DIP6	MOSFET / 1-Form-A	40
TLP597G	DIP6	MOSFET / 1-Form-A	40
TLP597GA	DIP6	MOSFET / 1-Form-A	40
TLP598AA	DIP6	MOSFET / 1-Form-A	40
TLP598GA	DIP6	MOSFET / 1-Form-A	40
TLP797GA	DIP6	MOSFET / 1-Form-A	40
TLP797GAF	DIP6	MOSFET / 1-Form-A	40
TLP797J	DIP6	MOSFET / 1-Form-A	40
TLP797JF	DIP6	MOSFET / 1-Form-A	40
TLP798GA	DIP6	MOSFET / 1-Form-A	40

SALES OFFICES

SUBSIDIARIES AND AFFILIATES

(As of April 15, 2015)

Toshiba America

Electronic Components, Inc.

- Irvine, Headquarters
Tel: (949)462-7700 Fax: (949)462-2200
- Buffalo Grove (Chicago)
Tel: (847)484-2400 Fax: (847)541-7287
- Duluth/Atlanta
Tel: (770)931-3363 Fax: (770)931-7602
- El Paso
Tel: (915)533-4242
- Marlborough
Tel: (508)481-0034 Fax: (508)481-8828
- Parsippany
Tel: (973)541-4715 Fax: (973)541-4716
- San Jose
Tel: (408)526-2400 Fax: (408)526-2410
- Wixom (Detroit)
Tel: (248)347-2607 Fax: (248)347-2602

TOSHIBA América do Sul Ltda.

Tel: (011)4083-7978

Toshiba India Private Ltd.

- New Delhi Office
Tel: (0124)499-6600 Fax: (0124)499-6611
- Bangalore Office
Tel: (080)251-9080 Fax: (080)490-91945

Toshiba Electronics Europe GmbH

- Düsseldorf Head Office
Tel: (0211)5296-0 Fax: (0211)5296-400
- France Branch
Tel: (1)47282181
- Italy Branch
Tel: (039)68701 Fax: (039)6870205
- Munich Office
Tel: (089)20302030 Fax: (089)203020310
- Spain Branch
Tel: (91)660-6798 Fax: (91)660-6799
- Sweden Branch
Tel: (08)704-0900 Fax: (08)80-8459
- U.K. Branch
Tel: (1932)841600

Toshiba Vietnam Consumer Products Co.,Ltd.

Tel: (043)776-5950 Fax: (043)776-5956

Toshiba Electronics Asia (Singapore) Pte. Ltd.

Tel: (6278)5252 Fax: (6271)5155

Toshiba Electronics Service (Thailand) Co., Ltd.

Tel: (02)835-3491 Fax: (02)835-3490

Toshiba Electronics Trading (Malaysia) Sdn. Bhd.

- Kuala Lumpur Head Office
Tel: (03)5631-6311 Fax: (03)5631-6307
- Penang Office
Tel: (04)226-8523 Fax: (04)226-8515

Toshiba Electronics (China) Co., Ltd.

- Shanghai Head Office
Tel: (021)6139-3888 Fax: (021)6190-8288
- Beijing Branch
Tel: (010)6590-8796 Fax: (010)6590-8791
- Chengdu Branch
Tel: (028)8675-1773 Fax: (028)8675-1065
- Hangzhou Office
Tel: (0571)8717-5004 Fax: (0571)8717-5013
- Nanjing Office
Tel: (025)8689-0070 Fax: (025)8689-0125
- Qingdao Branch
Tel: (532)8579-3328 Fax: (532)8579-3329
- Shenzhen Branch
Tel: (0755)3686-0880 Fax: (0755)3686-0816
- Dalian Branch
Tel: (0411)8368-6882 Fax: (0411)8369-0822
- Xiamen Branch
Tel: (0592)226-1398 Fax: (0592)226-1399
- Dongguan Branch
Tel: (0769)8155-6858 Fax: (0769)8155-6368
- Toshiba Electronics Asia, Ltd.
Tel: 2375-6111 Fax: 2375-0969
- Toshiba Electronics Korea Corporation
Tel: (02)3484-4334 Fax: (02)3484-4302
- Toshiba Electronic Components Taiwan Corporation
Tel: (02)2508-9988 Fax: (02)2508-9999

RESTRICTIONS ON PRODUCT USE

- ▶ Toshiba Corporation, and its subsidiaries and affiliates (collectively "TOSHIBA"), reserve the right to make changes to the information in this document, and related hardware, software and systems (collectively "Product") without notice.
- ▶ This document and any information herein may not be reproduced without prior written permission from TOSHIBA. Even with TOSHIBA's written permission, reproduction is permissible only if reproduction is without alteration/omission.
- ▶ Though TOSHIBA works continually to improve Product's quality and reliability, Product can malfunction or fail. Customers are responsible for complying with safety standards and for providing adequate designs and safeguards for their hardware, software and systems which minimize risk and avoid situations in which a malfunction or failure of Product could cause loss of human life, bodily injury or damage to property, including data loss or corruption. Before customers use the Product, create designs including the Product, or incorporate the Product into their own applications, customers must also refer to and comply with (a) the latest versions of all relevant TOSHIBA information, including without limitation, this document, the specifications, the data sheets and application notes for Product and the precautions and conditions set forth in the "TOSHIBA Semiconductor Reliability Handbook" and (b) the instructions for the application with which the Product will be used with or for. Customers are solely responsible for all aspects of their own product design or applications, including but not limited to (a) determining the appropriateness of the use of this Product in such design or applications; (b) evaluating and determining the applicability of any information contained in this document, or in charts, diagrams, programs, algorithms, sample application circuits, or any other referenced documents; and (c) validating all operating parameters for such designs and applications. **TOSHIBA ASSUMES NO LIABILITY FOR CUSTOMERS' PRODUCT DESIGN OR APPLICATIONS.**
- ▶ **PRODUCT IS NEITHER INTENDED NOR WARRANTED FOR USE IN EQUIPMENTS OR SYSTEMS THAT REQUIRE EXTRAORDINARILY HIGH LEVELS OF QUALITY AND/OR RELIABILITY, AND/OR A MALFUNCTION OR FAILURE OF WHICH MAY CAUSE LOSS OF HUMAN LIFE, BODILY INJURY, SERIOUS PROPERTY DAMAGE AND/OR SERIOUS PUBLIC IMPACT ("UNINTENDED USE").** Except for specific applications as expressly stated in this document, Unintended Use includes, without limitation, equipment used in nuclear facilities, equipment used in the aerospace industry, medical equipment, equipment used for automobiles, trains, ships and other transportation, traffic signaling equipment, equipment used to control combustions or explosions, safety devices, elevators and escalators, devices related to electric power, and equipment used in finance-related fields. **IF YOU USE PRODUCT FOR UNINTENDED USE, TOSHIBA ASSUMES NO LIABILITY FOR PRODUCT.** For details, please contact your TOSHIBA sales representative.
- ▶ Do not disassemble, analyze, reverse-engineer, alter, modify, translate or copy Product, whether in whole or in part.
- ▶ Product shall not be used for or incorporated into any products or systems whose manufacture, use, or sale is prohibited under any applicable laws or regulations.
- ▶ The information contained herein is presented only as guidance for Product use. No responsibility is assumed by TOSHIBA for any infringement of patents or any other intellectual property rights of third parties that may result from the use of Product. No license to any intellectual property right is granted by this document, whether express or implied, by estoppel or otherwise.
- ▶ **ABSENT A WRITTEN SIGNED AGREEMENT, EXCEPT AS PROVIDED IN THE RELEVANT TERMS AND CONDITIONS OF SALE FOR PRODUCT, AND TO THE MAXIMUM EXTENT ALLOWABLE BY LAW, TOSHIBA (1) ASSUMES NO LIABILITY WHATSOEVER, INCLUDING WITHOUT LIMITATION, INDIRECT, CONSEQUENTIAL, SPECIAL, OR INCIDENTAL DAMAGES OR LOSS, INCLUDING WITHOUT LIMITATION, LOSS OF PROFITS, LOSS OF OPPORTUNITIES, BUSINESS INTERRUPTION AND LOSS OF DATA, AND (2) DISCLAIMS ANY AND ALL EXPRESS OR IMPLIED WARRANTIES AND CONDITIONS RELATED TO SALE, USE OF PRODUCT, OR INFORMATION, INCLUDING WARRANTIES OR CONDITIONS OF MERCHANTABILITY, FITNESS FOR A PARTICULAR PURPOSE, ACCURACY OF INFORMATION, OR NON-INFRINGEMENT.**
- ▶ GaAs (Gallium Arsenide) is used in Product. GaAs is harmful to humans if consumed or absorbed, whether in the form of dust or vapor. Handle with care and do not break, cut, crush, grind, dissolve chemically or otherwise expose GaAs in Product.
- ▶ Do not use or otherwise make available Product or related software or technology for any military purposes, including without limitation, for the design, development, use, stockpiling or manufacturing of nuclear, chemical, or biological weapons or missile technology products (mass destruction weapons). Product and related software and technology may be controlled under the applicable export laws and regulations including, without limitation, the Japanese Foreign Exchange and Foreign Trade Law and the U.S. Export Administration Regulations. Export and re-export of Product or related software or technology are strictly prohibited except in compliance with all applicable export laws and regulations.
- ▶ Please contact your TOSHIBA sales representative for details as to environmental matters such as the RoHS compatibility of Product. Please use Product in compliance with all applicable laws and regulations that regulate the inclusion or use of controlled substances, including without limitation, the EU RoHS Directive. **TOSHIBA ASSUMES NO LIABILITY FOR DAMAGES OR LOSSES OCCURRING AS A RESULT OF NONCOMPLIANCE WITH APPLICABLE LAWS AND REGULATIONS.**

製品取り扱い上のお願い

- ▶ 本資料に掲載されているハードウェア、ソフトウェアおよびシステム(以下、本製品という)に関する情報等、本資料の掲載内容は、技術の進歩などにより予告なしに変更されることがあります。
- ▶ 文書による当社の事前の承諾なしに本資料の転載複製を禁じます。また、文書による当社の事前の承諾を得て本資料を転載複製する場合でも、記載内容に一切変更を加えたり、削除したりしないでください。
- ▶ 当社は品質、信頼性の向上に努めていますが、半導体・ストレージ製品は一般に誤作動または故障する場合があります。本製品をご使用頂く場合は、本製品の誤作動や故障により生命・身体・財産が侵害されることのないよう、お客様の責任において、お客様のハードウェア・ソフトウェア・システムに必要な安全設計を行うことをお願いします。なお、設計および使用に際しては、本製品に関する最新の情報(本資料、仕様書、データシート、アプリケーションノート、半導体信頼性ハンドブックなど)および本製品が使用される機器の取扱説明書、操作説明書などをご確認の上、これに従ってください。また、上記資料などに記載の製品データ、図、表などに示す技術的な内容、プログラム、アルゴリズムその他応用回路例などの情報を使用する場合は、お客様の製品単独およびシステム全体で十分に評価し、お客様の責任において適用可否を判断してください。
- ▶ 本製品は、特別に高い品質・信頼性が要求され、またはその故障や誤作動が生命・身体に危害を及ぼす恐れ、膨大な財産損害を引き起こす恐れ、もしくは社会に深刻な影響を及ぼす恐れのある機器(以下"特定用途"という)に使用されることは意図されていませんし、保証もされていません。特定用途には原子力関連機器、航空・宇宙機器、医療機器、車載・輸送機器、列車・船舶機器、交通信号機器、燃焼・爆発制御機器、各種安全関連機器、昇降機器、電力機器、金融関連機器などが含まれますが、本資料に個別に記載する用途は除きます。特定用途に使用された場合には、当社は一切の責任を負いません。なお、詳細は当社営業窓口までお問い合わせください。
- ▶ 本製品を分解、解析、リバースエンジニアリング、改造、改変、翻案、複製等しないでください。
- ▶ 本製品を、国内外の法令、規則及び命令により、製造、使用、販売を禁止されている製品に使用することはできません。
- ▶ 本資料に掲載してある技術情報は、製品の代表的動作・応用を説明するためのもので、その使用に際して当社及び第三者の知的財産権その他の権利に対する保証または実施権の許諾を行うものではありません。
- ▶ 別途、書面による契約またはお客様と当社が合意した仕様書がない限り、当社は、本製品および技術情報に関して、明示的にも黙示的にも一切の保証(機能動作の保証、商品性の保証、特定目的への合致の保証、情報の正確性の保証、第三者の権利の非侵害保証を含むがこれに限らない。)をしておりません。
- ▶ 本製品にはGaAs(ガリウムヒ素)が使われています。その粉末や蒸気等は人体に対し有害ですので、破壊、切断、粉砕や化学的な分解はしないでください。
- ▶ 本製品、または本資料に掲載されている技術情報を、大量破壊兵器の開発等の目的、軍事利用の目的、あるいはその他軍事用途の目的で使用しないでください。また、輸出に際しては、「外国為替及び外国貿易法」、「米国の輸出管理規則」等、適用ある輸出関連法令を遵守し、それらの定めるところにより必要な手続を行ってください。
- ▶ 本製品のRoHS適合性など、詳細につきましては製品個別に必ず当社営業窓口までお問い合わせください。本製品のご使用に際しては、特定の物質の含有・使用を規制するRoHS指令等、適用ある環境関連法令を十分調査の上、かかる法令に適合するようご使用ください。お客様がかかる法令を遵守しないことにより生じた損害に関して、当社は一切の責任を負いかねます。

【お問い合わせ先】

TOSHIBA

©2016 TOSHIBA CORPORATION

Previous edition: BCA0034A

TOSHIBA CORPORATION Semiconductor & Storage Products Company

株式会社 東芝 セミコンダクター&ストレージ社

http://toshiba.semicon-storage.com/