

## Optocoupler, Phototransistor Output, AC Input

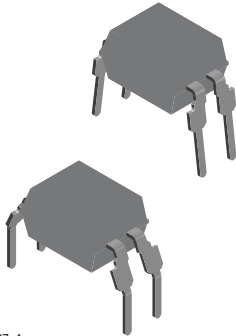

17197\_4

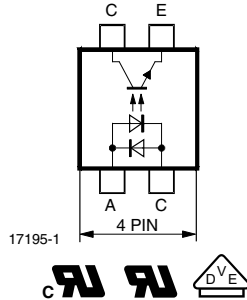

### DESCRIPTION

The TCET1600, TCET1600G consists of a phototransistor optically coupled to 2 gallium arsenide infrared-emitting diodes in a single (4 pin) package.

### VDE STANDARDS

These couplers perform safety functions according to the following equipment standards:

- **DIN EN 60747-5-2 (VDE 0884)**  
Optocoupler for electrical safety requirements
- **IEC 60950/EN 60950**  
Office machines (applied for reinforced isolation for mains voltage  $\leq 400 V_{RMS}$ )
- **VDE 0804**  
Telecommunication apparatus and data processing
- **IEC 60065**  
Safety for mains-operated electronic and related household apparatus
- **VDE 0700/IEC 335**  
Household equipment
- **VDE 0160**  
Electronic equipment for electrical power installation
- **VDE 0750/IEC 60601**  
Medical equipment

### FEATURES

- Isolation materials according to UL94 V-O
- Pollution degree 2 (DIN/VDE 0110 /resp. IEC 60664)
- Climatic classification 55/100/21 (IEC 60068 part 1)
- Special construction: therefore, extra low coupling capacity of typical 0.2 pF, high common mode rejection
- Low temperature coefficient of CTR
- Rated impulse voltage (transient overvoltage)  $V_{IOTM} = 10 \text{ kV peak}$
- Isolation test voltage (partial discharge test voltage)  $V_{pd} = 1.6 \text{ kV peak}$
- Rated isolation voltage (RMS includes DC)  $V_{IOWM} = 600 V_{RMS}$
- Rated recurring peak voltage (repetitive)  $V_{IORM} = 890 V_{peak}$
- Thickness though insulation  $\geq 0.75 \text{ mm}$
- Creepage current resistance according to VDE 0303/ IEC 60112 comparative tracking index:  $CTI \geq 175$
- Compliant to RoHS Directive 2002/95/EC and in accordance to WEEE 2002/96/EC



**RoHS**  
COMPLIANT

### AGENCY APPROVALS

- UL1577, file no. E52744 system code H, double protection
- CSA 22.2 bulletin 5A
- DIN EN 60747-5-2 (VDE 0884)
- DIN EN 60747-5-5 (pending)
- FIMKO

### ORDERING INFORMATION

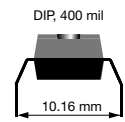
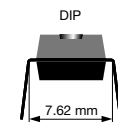
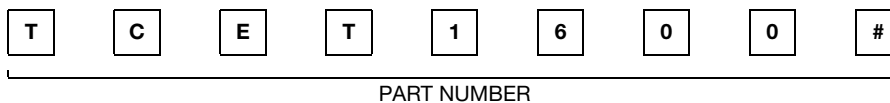

<b>AGENCY CERTIFIED/PACKAGE</b>	<b>CTR (%)</b>
	<b>± 5 mA</b>
<b>UL, cUL, VDE, FIMKO</b>	<b>20 to 300</b>
DIP-4, single channel	TCET1600
DIP-4, single channel, 400 mil	TCET1600G

### Note

- G = leadform 10.16 mm; G is not marked on the body.

<b>ABSOLUTE MAXIMUM RATINGS</b> <sup>(1)</sup> ( $T_{amb} = 25\text{ }^{\circ}\text{C}$ , unless otherwise specified)				
PARAMETER	TEST CONDITION	SYMBOL	VALUE	UNIT
<b>INPUT</b>				
Reverse voltage		$V_R$	6	V
Forward current		$I_F$	$\pm 60$	mA
Forward surge current	$t_p \leq 10\text{ }\mu\text{s}$	$I_{FSM}$	$\pm 1.5$	A
Power dissipation		$P_{diss}$	100	mW
Junction temperature		$T_j$	125	$^{\circ}\text{C}$
<b>OUTPUT</b>				
Collector emitter voltage		$V_{CEO}$	70	V
Emitter collector voltage		$V_{ECO}$	7	V
Collector current		$I_C$	50	mA
Collector peak current	$t_p/T = 0.5, t_p \leq 10\text{ ms}$	$I_{CM}$	100	mA
Power dissipation		$P_{diss}$	150	mW
Junction temperature		$T_j$	125	$^{\circ}\text{C}$
<b>COUPLER</b>				
Isolation test voltage (RMS)	$t = 1\text{ s}$	$V_{ISO}$	5300	$V_{RMS}$
Isolation voltage		$V_{IORM}$	890	$V_P$
Total power dissipation		$P_{tot}$	250	mW
Operating ambient temperature range		$T_{amb}$	- 55 to + 100	$^{\circ}\text{C}$
Storage temperature range		$T_{stg}$	- 55 to + 150	$^{\circ}\text{C}$
Soldering temperature <sup>(2)</sup>	2 mm from case, $t \leq 10\text{ s}$	$T_{sld}$	260	$^{\circ}\text{C}$

### Notes

- <sup>(1)</sup> Stresses in excess of the absolute maximum ratings can cause permanent damage to the device. Functional operation of the device is not implied at these or any other conditions in excess of those given in the operational sections of this document. Exposure to absolute maximum ratings for extended periods of the time can adversely affect reliability.
- <sup>(2)</sup> Refer to wave profile for soldering conditions for through hole devices (DIP).

<b>ELECTRICAL CHARACTERISTICS</b> ( $T_{amb} = 25\text{ }^{\circ}\text{C}$ , unless otherwise specified)						
PARAMETER	TEST CONDITION	SYMBOL	MIN.	TYP.	MAX.	UNIT
<b>INPUT</b>						
Forward voltage	$I_F = \pm 50\text{ mA}$	$V_F$		1.25	1.6	V
Junction capacitance	$V_R = 0\text{ V}, f = 1\text{ MHz}$	$C_j$		50		pF
<b>OUTPUT</b>						
Collector emitter voltage	$I_C = 100\text{ }\mu\text{A}$	$V_{CEO}$	70			V
Emitter collector voltage	$I_E = 100\text{ }\mu\text{A}$	$V_{ECO}$	7			V
Collector dark current	$V_{CE} = 20\text{ V}, I_F = 0, E = 0$	$I_{CEO}$			100	nA
<b>COUPLER</b>						
Collector emitter saturation voltage	$I_F = 10\text{ mA}, I_C = 1\text{ mA}$	$V_{CEsat}$			0.3	V
Cut-off frequency	$V_{CE} = 5\text{ V}, I_F = 10\text{ mA}, R_L = 100\text{ }\Omega$	$f_c$		100		kHz
Coupling capacitance	$f = 1\text{ MHz}$	$C_k$		0.3		pF

### Note

- Minimum and maximum values were tested requirements. Typical values are characteristics of the device and are the result of engineering evaluations. Typical values are for information only and are not part of the testing requirements.



CURRENT TRANSFER RATIO						
PARAMETER	TEST CONDITION	SYMBOL	MIN.	TYP.	MAX.	UNIT
$I_C/I_F$	$V_{CE} = 5\text{ V}, I_F = \pm 5\text{ mA}$	CTR	20		300	%

MAXIMUM SAFETY RATINGS						
PARAMETER	TEST CONDITION	SYMBOL	MIN.	TYP.	MAX.	UNIT
<b>INPUT</b>						
Forward current		$I_F$			275	mA
<b>OUTPUT</b>						
Power dissipation		$P_{diss}$			400	mW
<b>COUPLER</b>						
Rated impulse voltage		$V_{IOTM}$			10	kV
Safety temperature		$T_{si}$			175	°C

**Note**

- According to DIN EN 60747-5-2 (VDE 0884) (see figure 1). This optocoupler is suitable for safe electrical isolation only within the safety ratings. Compliance with the safety ratings shall be ensured by means of suitable protective circuits.

INSULATION RATED PARAMETERS						
PARAMETER	TEST CONDITION	SYMBOL	MIN.	TYP.	MAX.	UNIT
Partial discharge test voltage - routine test	100 %, $t_{test} = 1\text{ s}$	$V_{pd}$	1.669			kV
Partial discharge test voltage - lot test (sample test)	$t_{Tr} = 60\text{ s}, t_{test} = 10\text{ s}$ , (see figure 2)	$V_{IOTM}$	10			kV
		$V_{pd}$	1.424			kV
Insulation resistance	$V_{IO} = 500\text{ V}$	$R_{IO}$	$10^{12}$			$\Omega$
	$V_{IO} = 500\text{ V}, T_{amb} = 100\text{ °C}$	$R_{IO}$	$10^{11}$			$\Omega$
	$V_{IO} = 500\text{ V}, T_{amb} = 150\text{ °C}$ (construction test only)	$R_{IO}$	$10^9$			$\Omega$

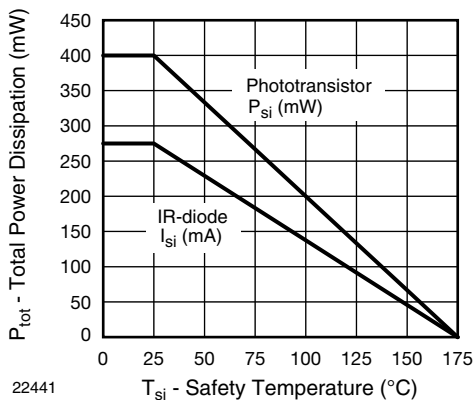

Fig. 1 - Derating Diagram

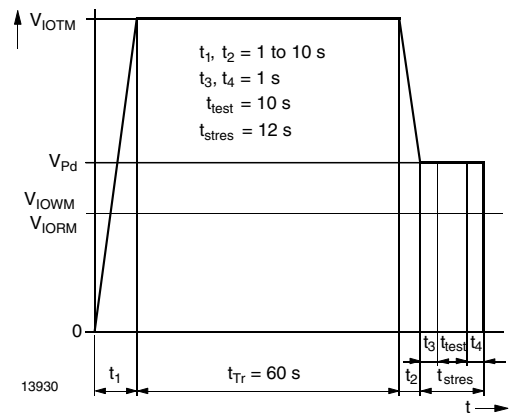

Fig. 2 - Test Pulse Diagram for Sample Test acc. to DIN EN 60747-5-2 (VDE 0884); IEC60747-5-5

SWITCHING CHARACTERISTICS						
PARAMETER	TEST CONDITION	SYMBOL	MIN.	TYP.	MAX.	UNIT
Delay time	$V_S = 5\text{ V}$ , $I_C = 2\text{ mA}$ , $R_L = 100\ \Omega$ , (see figure 3)	$t_d$		3		$\mu\text{s}$
Rise time	$V_S = 5\text{ V}$ , $I_C = 2\text{ mA}$ , $R_L = 100\ \Omega$ , (see figure 3)	$t_r$		3		$\mu\text{s}$
Turn-on time	$V_S = 5\text{ V}$ , $I_C = 2\text{ mA}$ , $R_L = 100\ \Omega$ , (see figure 3)	$t_{on}$		6		$\mu\text{s}$
Storage time	$V_S = 5\text{ V}$ , $I_C = 2\text{ mA}$ , $R_L = 100\ \Omega$ , (see figure 3)	$t_s$		0.3		$\mu\text{s}$
Fall time	$V_S = 5\text{ V}$ , $I_C = 2\text{ mA}$ , $R_L = 100\ \Omega$ , (see figure 3)	$t_f$		4.7		$\mu\text{s}$
Turn-off time	$V_S = 5\text{ V}$ , $I_C = 2\text{ mA}$ , $R_L = 100\ \Omega$ , (see figure 3)	$t_{off}$		5		$\mu\text{s}$
Turn-on time	$V_S = 5\text{ V}$ , $I_F = 10\text{ mA}$ , $R_L = 1\text{ k}\Omega$ , (see figure 4)	$t_{on}$		9		$\mu\text{s}$
Turn-off time	$V_S = 5\text{ V}$ , $I_F = 10\text{ mA}$ , $R_L = 1\text{ k}\Omega$ , (see figure 4)	$t_{off}$		10		$\mu\text{s}$

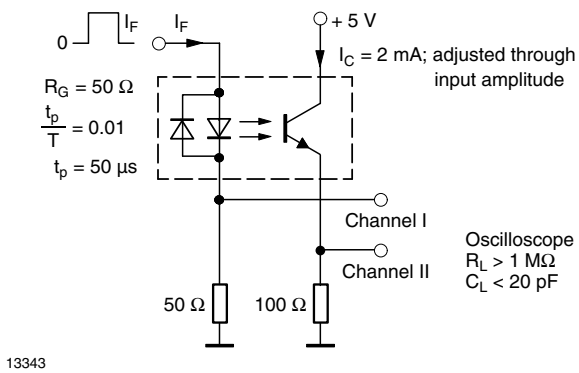

Fig. 3 - Test Circuit, Non-Saturated Operation

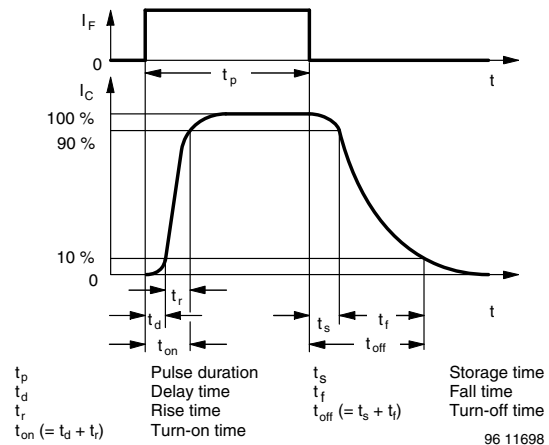

Fig. 5 - Switching Times

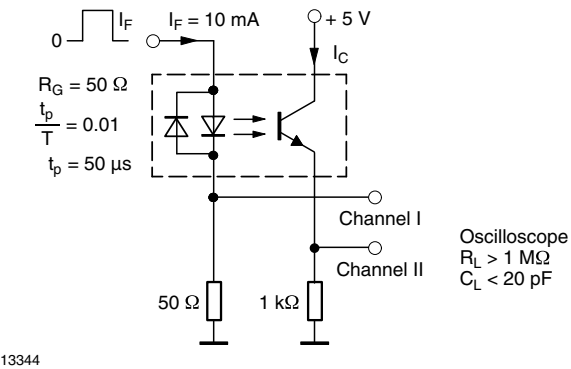

Fig. 4 - Test Circuit, Saturated Operation

### TYPICAL CHARACTERISTICS ( $T_{amb} = 25\text{ }^{\circ}\text{C}$ , unless otherwise specified)

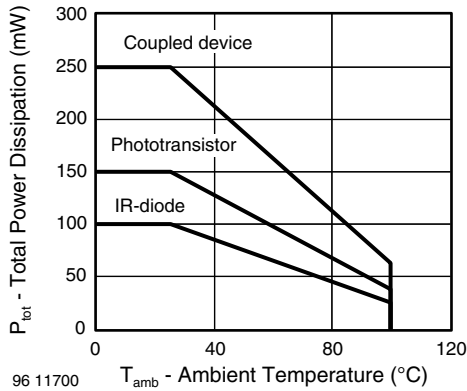

Fig. 6 - Total Power Dissipation vs. Ambient Temperature

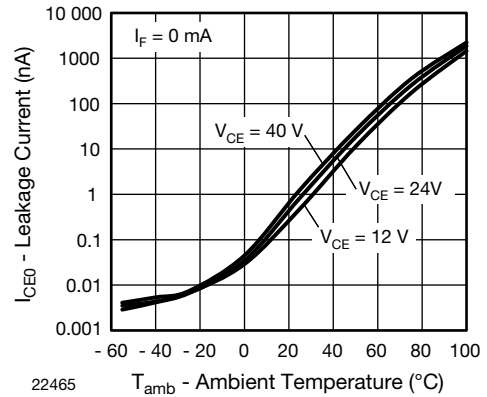

Fig. 9 - Leakage Current vs. Ambient Temperature

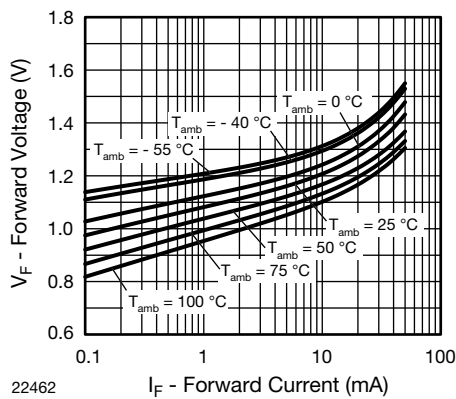

Fig. 7 - Forward Current vs. Forward Voltage

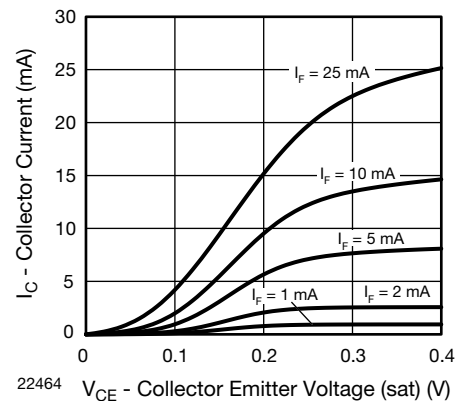

Fig. 10 - Collector Current vs. Collector Emitter Voltage (sat)

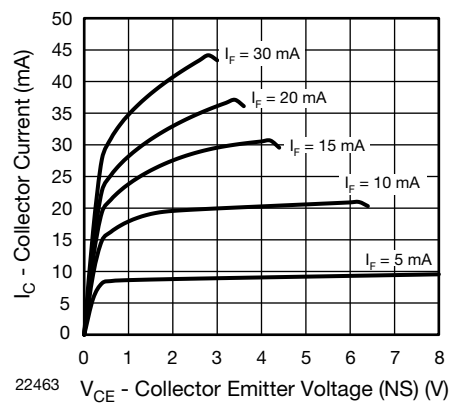

Fig. 8 - Collector Current vs. Collector Emitter Voltage (NS)

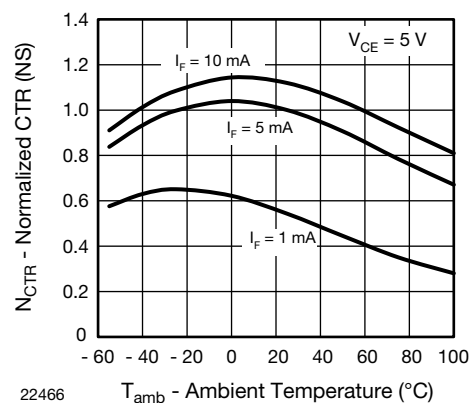

Fig. 11 - Normalized CTR (NS) vs. Ambient Temperature

# TCET1600, TCET1600G



Vishay Semiconductors Optocoupler, Phototransistor Output,  
AC Input

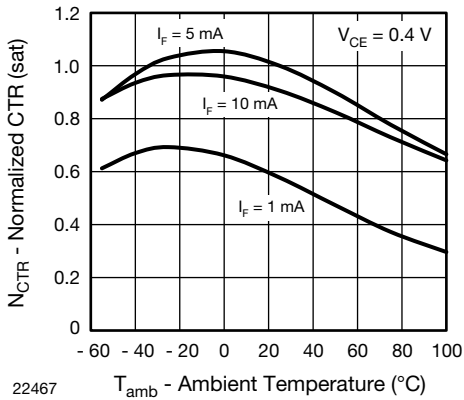

Fig. 12 - Normalized CTR (sat) vs. Ambient Temperature

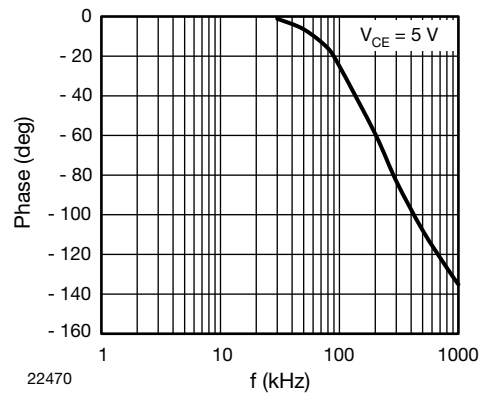

Fig. 15 -  $F_{CTR}$  vs. Phase Angle

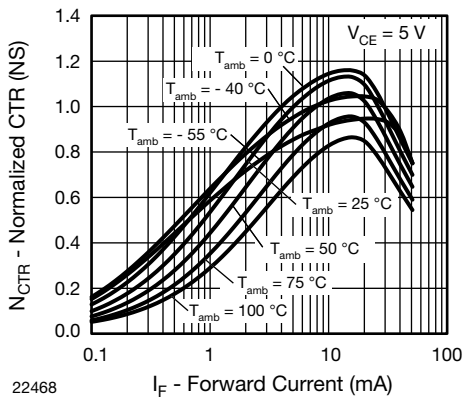

Fig. 13 - Normalized CTR (NS) vs. Forward Current

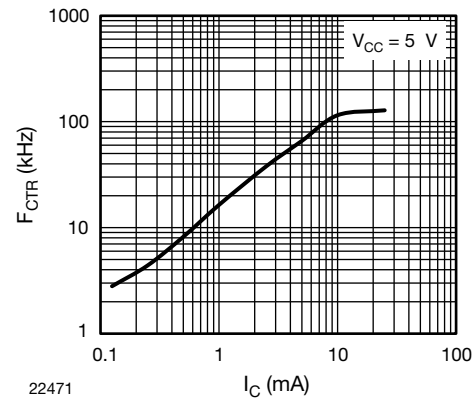

Fig. 16 -  $F_{CTR}$  vs.  $I_C$

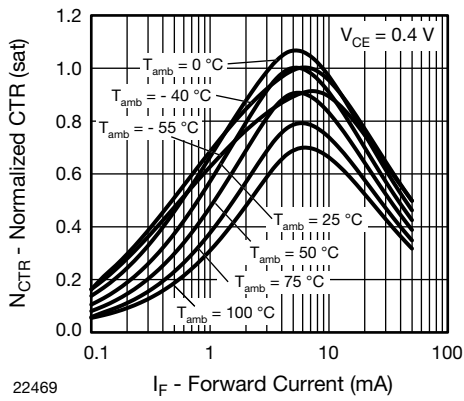

Fig. 14 - Normalized CTR (sat) vs. Forward Current

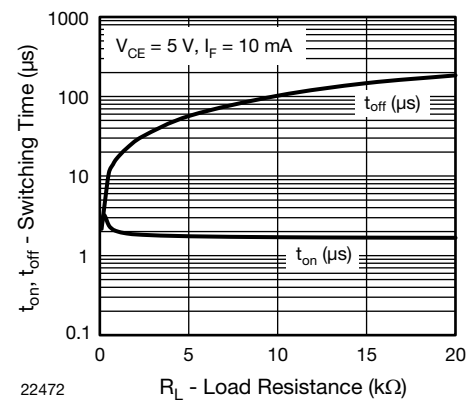

Fig. 17 - Switching Time vs. Load Resistance



# TCET1600, TCET1600G

Optocoupler, Phototransistor Output, Vishay Semiconductors  
AC Input

## PACKAGE DIMENSIONS in millimeters

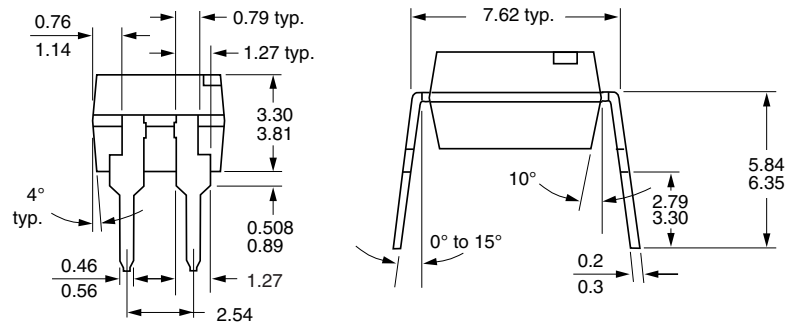
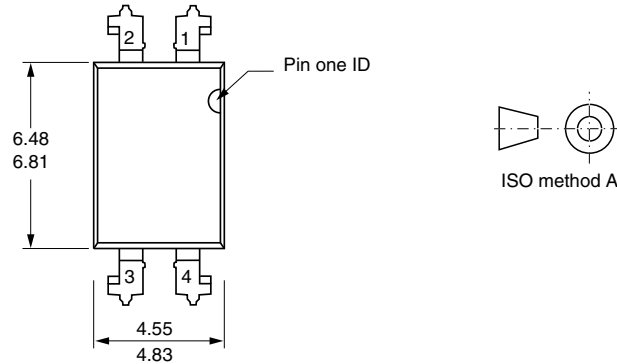

i178027

### Option 6

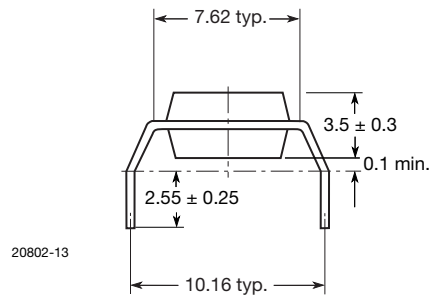

20802-13

## PACKAGE MARKING (example)



21764-93



## **Disclaimer**

ALL PRODUCT, PRODUCT SPECIFICATIONS AND DATA ARE SUBJECT TO CHANGE WITHOUT NOTICE TO IMPROVE RELIABILITY, FUNCTION OR DESIGN OR OTHERWISE.

Vishay Intertechnology, Inc., its affiliates, agents, and employees, and all persons acting on its or their behalf (collectively, "Vishay"), disclaim any and all liability for any errors, inaccuracies or incompleteness contained in any datasheet or in any other disclosure relating to any product.

Vishay makes no warranty, representation or guarantee regarding the suitability of the products for any particular purpose or the continuing production of any product. To the maximum extent permitted by applicable law, Vishay disclaims (i) any and all liability arising out of the application or use of any product, (ii) any and all liability, including without limitation special, consequential or incidental damages, and (iii) any and all implied warranties, including warranties of fitness for particular purpose, non-infringement and merchantability.

Statements regarding the suitability of products for certain types of applications are based on Vishay's knowledge of typical requirements that are often placed on Vishay products in generic applications. Such statements are not binding statements about the suitability of products for a particular application. It is the customer's responsibility to validate that a particular product with the properties described in the product specification is suitable for use in a particular application. Parameters provided in datasheets and / or specifications may vary in different applications and performance may vary over time. All operating parameters, including typical parameters, must be validated for each customer application by the customer's technical experts. Product specifications do not expand or otherwise modify Vishay's terms and conditions of purchase, including but not limited to the warranty expressed therein.

Except as expressly indicated in writing, Vishay products are not designed for use in medical, life-saving, or life-sustaining applications or for any other application in which the failure of the Vishay product could result in personal injury or death. Customers using or selling Vishay products not expressly indicated for use in such applications do so at their own risk. Please contact authorized Vishay personnel to obtain written terms and conditions regarding products designed for such applications.

No license, express or implied, by estoppel or otherwise, to any intellectual property rights is granted by this document or by any conduct of Vishay. Product names and markings noted herein may be trademarks of their respective owners.