



# profile LED **SURFACE**



Surface LED profile

## profile LED SURFACE BC/UX

UE Patent No. 001321780-0003

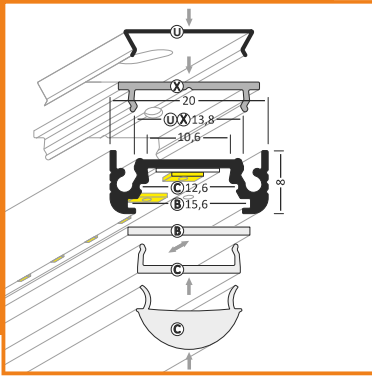

anodized  
1000mm **77260020**  
2000mm **77270020**



black anodized  
1000mm **77260021**  
2000mm **77270021**



white painted  
1000mm **77260001**  
2000mm **77270001**

effect of interesting light lines;  
flat mounting backwards or  
sideways in the slots;  
individually or in groups

standard lengths: 1000, 2000mm;  
max. length 4000mm;  
length above 2000mm - own collection

## covers

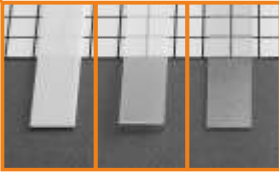

cover slide B  
white ▶ frosted ▶ transparent  
1000mm **76240038** 1000mm **76240039** 1000mm **76240016**  
2000mm 2000mm 2000mm  
2000mm **76250038** 2000mm **76250039** 2000mm **76250016**

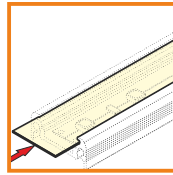

cover dick C  
white ▶ transparent  
1000mm **76320038** 1000mm **76320000**  
2000mm 2000mm  
2000mm **76330038** 2000mm **76330000**

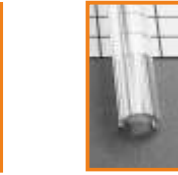
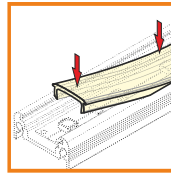

cover lens C  
transparent  
1000mm **76290000**  
2000mm **76300000**

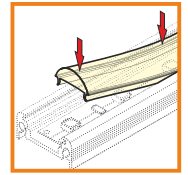

## endings

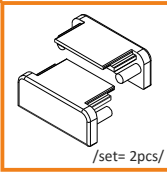

ending SURFACE  
grey ▶ **70360022**  
white ▶ **70360001**  
black ▶ **70360002**  
silver ▶ **70360040**

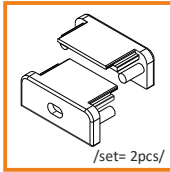

ending SURFACE with hole  
**77540022**  
**77540001**  
**77540002**  
**77540040**

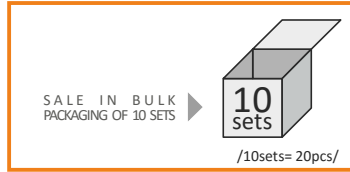

SALE IN BULK  
PACKAGING OF 10 SETS  
10 sets  
/10sets= 20pcs/  
ending SURFACE  
**77280022 (min.10x)**  
**77280001 (min.10x)**  
**77280002 (min.10x)**  
**77280040 (min.10x)**  
ending SURFACE with hole  
**77520022 (min.10x)**  
**77520001 (min.10x)**  
**77520002 (min.10x)**  
**77520040 (min.10x)**

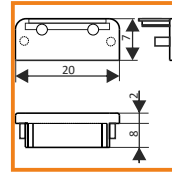

ENDING THICKNESS INCREASES  
THE LENGTH OF THE PROFILE

## mounting

OPTIONAL MOUNTING:



mounting plate X  
**76260000**

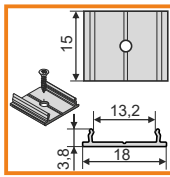

mounting plate U  
**76380000**



holder SURFACE simple  
**77370030**

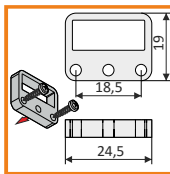

connector L SURFACE



connector X  
**76350000**

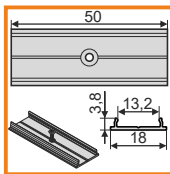

anodized **77410020**  
black anodized **77410021**  
white painted **77410001**

