

6002-2RSH

SKF Explorer

Dimensions

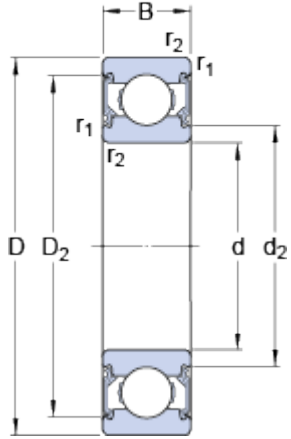

d	15	mm
D	32	mm
B	9	mm
d ₂	18.35	mm
D ₂	28.2	mm
r _{1,2}	min. 0.3	mm

Abutment dimensions

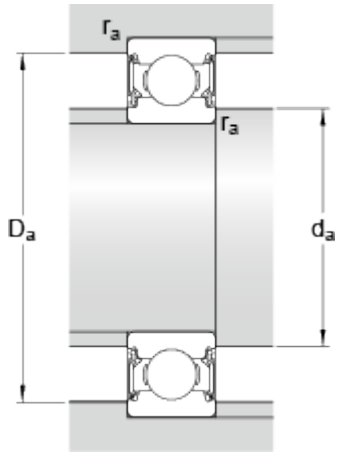

d _a	min. 17	mm
d _a	max. 18.5	mm
D _a	max. 30	mm
r _a	max. 0.3	mm

Calculation data

Basic dynamic load rating	C	5.8	kN
Basic static load rating	C ₀	2.8	kN
Fatigue load limit	P _u	0.12	kN
Limiting speed		14000	r/min
Calculation factor	k _r	0.025	
Calculation factor	f ₀	14	

Mass

Mass bearing	0.0303	kg
--------------	--------	----