

Overview



7PV15, SIRIUS 3RP25 and SIRIUS 3RP20 timing relays

More information

Homepage, see www.siemens.com/relays

Industry Mall, see www.siemens.com/product?3RP

Electronic timing relays are used in control, starting, and protective circuits for all switching operations involving time delays. Their fully developed concept and space-saving, compact design make the SIRIUS 3RP timing relays ideal modules for control cabinet, switchgear and control manufacturers in the industry.

With their narrow design, the 7PV15 timing relays are ideal in particular for use in heating, ventilation and air-conditioning systems and in compressors. All 7PV15 timing relays in this enclosure version are suitable for snap-on mounting onto TH 35 standard mounting rails according to IEC 60175. The enclosure complies with DIN 43880.

Benefits

- Clear-cut basic range with five basic units in the case of the 7PV15 timing relays, and seven basic units in the case of the 3RP timing relays
- Logistic advantages provided by versions with wide voltage range and wire setting range
- No tools required for assembly or disassembly on standard mounting rails
- Cadmium-free relay contacts
- Recyclable, halogen-free enclosure
- Optimum price/performance ratio
- Versions with logical separation
- Low variance: One design for distribution boards and for control cabinets
- Compliance with EMC requirements for buildings
- Environmentally friendly laser inscription instead of printing containing solvents
- Timing relays suitable for the 3RT miniature contactors allow smaller tier spacing
- Versions with screw terminals or alternatively with spring-type terminals

Application

Timing relays with ON-delay

- Interference pulse suppression (gating of interference pulses)
- Gradual startup of motors so as not to overload the power supply

Timing relays with OFF-delay

- Generation of overtravel functions following removal of voltage
- Gradual, delayed shutdown, e.g. of motors or fans, to allow a plant to be shut down selectively

Wye-delta timing relays

- Switching over motors from Wye to delta with a dead interval of 50 ms to prevent phase-to-phase short circuits

Multifunctional timing relays

- Maximum flexibility, with a device for every application
- Available with relay and semiconductor output

Relays

Timing Relays

SIRIUS 3RP25 timing relays, 17.5 mm and 22.5 mm

Overview

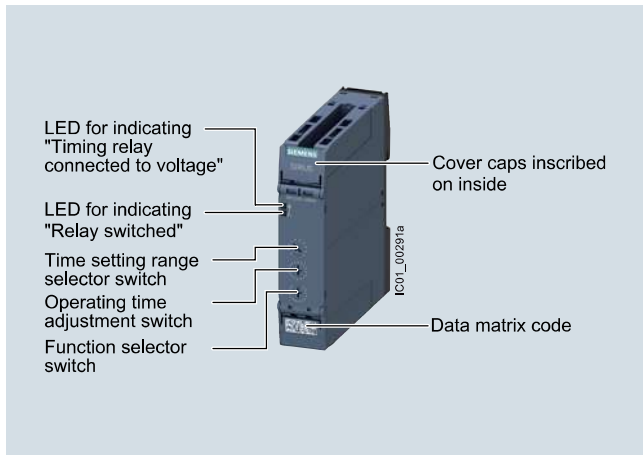

SIRIUS 3RP25 timing relays

More information

Homepage, see www.siemens.com/relays
 Industry Mall, see www.siemens.com/product?3RP25
 For the conversion tool, e.g. from 3RP15 to 3RP25, see www.siemens.com/sirius/conversion-tool

Electronic timing relays for general use in control systems and mechanical engineering with:

- 1 or 2 CO, 1 NO (semiconductor) or 3 NO
- Monofunction or multifunction
- Combination voltage or wide voltage range
- Single or selectable time setting ranges
- Switch position indication and voltage indication by LED

Article No. scheme

Product versions		Article number								
Timing relays		3RP25	□	□	-	□	□	□	□	0
Product function/ time setting ranges	Multifunction	0	5							7 time ranges 0.05 s ... 100 h
	ON-delay	1	1							1 time range 0.5 ... 10 s
		1	2							1 time range 1 ... 3 s
		1	3							1 time range 5 ... 100 s
		2	5							7 time ranges 0.05 s ... 100 h
		2	7							4 time ranges 0.05 s... 240 s
	OFF-delay with control signal	3	5							7 time ranges 0.05 s ... 100 h
	OFF-delay without control signal, non-volatile, passing make contact	4	0							7 time ranges 0.05 s ... 600 s
	Clock-pulse relay, flashing, asymmetrical	5	5							7 time ranges 0.05 s ... 100 h
Wye-delta function with coasting function (idling)	6	0							Wye-delta 1 ... 20 s, coasting time (idling) 600 s	
Wye-delta function	7	4							1 time range 1 ... 20 s	
		7	6							1 time range 3 ... 60 s
Connection type	Screw terminals								1	
	Spring-type terminals (push-in)								2	
Contacts	1 CO									A
	2 CO									B
	Semiconductors (transistor NPN)									C
	Semiconductors (thyristor), two-wire									E
	1 NO + 1 NO (SD)									N
	2 CO positively driven									R
	3 NO									S
Control supply voltage	24 V AC/DC									B 3
	200 ... 240 V/380 ... 440 V AC									M 2
	400 ... 440 V AC									T 2
	12 ... 240 V AC/DC or									W 3
	24 ... 240 V AC/DC (3RP2505-.RW30)									
Example		3RP25	0	5	-	1	A	B	3	0

Note:

The Article No. scheme shows an overview of product versions for better understanding of the logic behind the article numbers.

For your orders, please use the article numbers quoted in the selection and ordering data.

SIRIUS 3RP25 timing relays, 17.5 mm and 22.5 mm

3RP2505 multifunctional timing relays

Two setting options for implementing the multifunctions (A-M):



- ① Determination of 13 functions by the setting A to M, with 1 CO, 1 NO, 2 CO that switch in parallel.
- ② Extended function variance by selecting the time range and determining, whether 2 CO switch in parallel or whether 1 CO switches with delay + 1 CO switches immediately (1 CO + 1 CO)

Setting the functions on the device

The functions of the 3RP2505 multifunctional timing relays can be set by means of the function selector switch. Whether both CO contacts are switched in parallel or one CO contact with a delay and one instantaneously and the choice of time setting range are set by means of the time setting range selector switch. The exact operating time can be adjusted with the operating time switch.

Overview of functions

Identifica- tion letter	13 functions	27 functions
	1 CO contact (1 CO), 1 NO contact (1 NO) semiconductor, 2 CO contacts switched in parallel (2 CO) or 2 CO contacts positively driven and switched in parallel with delay (2 CO)	13 functions (A - M) 2 CO contacts switched in parallel (2 CO) + 13 functions (A - M) 1 CO delayed contact + 1 CO instantaneous contact (1 CO + 1 CO) and wye-delta function
A	ON-delay	ON-delay and instantaneous contact
B	OFF-delay with control signal	OFF-delay with control signal and instantaneous contact
C	ON-delay/OFF-delay with control signal	ON-delay/OFF-delay with control signal and instantaneous contact
D	Flashing, symmetrical, starting with interval	Flashing, symmetrical, starting with interval and instantaneous contact
E	Passing make contact, interval relay	Passing make contact, interval relay and instantaneous contact
F	Retriggerable interval relay with deactivated control signal (passing break contact with control signal)	Retriggerable interval relay with deactivated control signal (passing break contact with control signal) and instantaneous contact
G	Passing make contact, with control signal, not retriggerable (pulse-forming with control signal)	Passing make contact, with control signal, not retriggerable, (pulse-forming with control signal) and instantaneous contact
H	Additive ON-delay, instantaneous OFF with control signal	Additive ON-delay, instantaneous OFF with control signal and instantaneous contact
I	Additive ON-delay with control signal	Additive ON-delay with control signal and instantaneous contact
J	Flashing, symmetrical, starting with pulse	Flashing, symmetrical, starting with pulse and instantaneous contact
K	Pulse-delayed (fixed pulse (at 1 s) and settable pulse delay)	Pulse-delayed (fixed pulse (at 1 s) and settable pulse delay) and instantaneous contact
L	Pulse-delayed with control signal (fixed pulse (at 1 s) and settable pulse delay)	Pulse-delayed with control signal (fixed pulse (at 1 s) and settable pulse delay) and instantaneous contact
M	Retriggerable interval relay with activated control signal (watchdog)	Retriggerable interval relay with activated control signal and instantaneous contact (watchdog)
--	--	Wye-delta function

With a set of foil labels the timing relay can be legibly marked with the functions which can be selected on the timing relay. This is supplied together with the multifunctional timing relay.

The same potential must be applied to terminals A. and B.

Note:

The activation of loads parallel to the start input is permissible when using AC/DC control voltage (see circuit diagram).

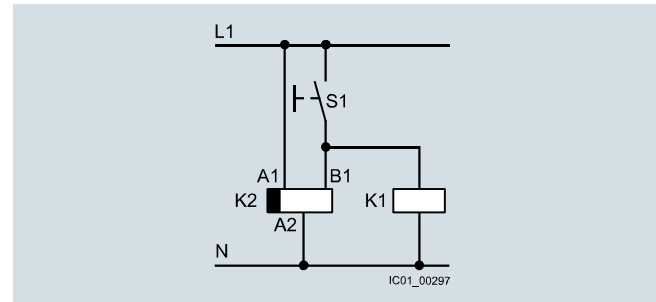

Diagram

Relays

Timing Relays

SIRIUS 3RP25 timing relays, 17.5 mm and 22.5 mm

Benefits

- Easy stock keeping and logistics thanks to low variance of devices
- Reduced space requirement in the control cabinet thanks to variants in width 17.5 mm and 22 mm
- Consistent for all functions thanks to wide voltage range from 12 to 240 V AC/DC
- Up to 27 functions according to IEC 61812 in the multifunctional timing relay with wide voltage range
- Multifunctional timing relay with semiconductor output for high switching frequencies, bounce-free and wear-free switching

Standards and approvals

- IEC 60721-3-3 "Classification of environmental conditions"
- IEC 61812-1/DIN VDE 0435 Part 2021 "Specified time relays for industrial use"
- IEC 61000-6-2, IEC 61000-6-3 and IEC 61000-6-4 "Electromagnetic compatibility"
- IEC 60947-5-1 "Low-voltage switchgear and controlgear – Electromechanical control circuit devices"

Application

Timing relays are used in control, starting, and protective circuits for all switching operations involving time delays. They guarantee a high level of functionality and a high repeat accuracy of timer settings.

Enclosure version

All timing relays are suitable for snap-on mounting onto TH 35 standard mounting rails according to IEC 60715 or for screw fixing.

SIRIUS 3RP25 timing relays, 17.5 mm and 22.5 mm
Technical specifications
More information

Technical specifications, see
<https://support.industry.siemens.com/cs/ww/en/ps/16354/td>
 Manual, see
<https://support.industry.siemens.com/cs/ww/en/view/103532830>

Internal circuit diagrams, see [CAx Download Manager](#)
<https://support.industry.siemens.com/my/ww/en/CAxOnline#CAxOnline>
 FAQs, see <https://support.industry.siemens.com/cs/ww/en/ps/16354/faq>

Article number	3RP2505-A, 3RP2505-C, 3RP251., 3RP2525-A, 3RP2527, 3RP253., 3RP255.	3RP2505-B, 3RP2505-R, 3RP2525-B, 3RP254., 3RP256., 3RP257.
Width x height x depth	mm 17.5 x 100 x 90	22.5 x 100 x 90

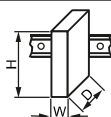

Article number	3RP25...-AB30, 3RP25...-AW30, 3RP25...-BB30, 3RP25...-BW30, 3RP25...-NW30, 3RP25...-SW30	3RP25...-BT20, 3RP25...-NM20	3RP25...-CW30	3RP25...-EW30	3RP25...-RW30
----------------	---	---	----------------------	----------------------	----------------------

General technical specifications

Insulation voltage for overvoltage category III to IEC 60664 for pollution degree 3, rated value	V AC	300	500	300	--	300
Ambient temperature						
• During operation	°C	-25 ... +60				-40 ... +70
• During storage	°C	-40 ... +85				
Operating range factor of the control supply voltage, rated value						
• At AC						
- At 50 Hz		0.85 ... 1.1				0.7 ... 1.1
- At 60 Hz		0.85 ... 1.1				0.7 ... 1.1
• At DC		0.85 ... 1.1	--	0.85 ... 1.1	0.85 ... 1.1	0.7 ... 1.1
Switching capacity current with inductive load	A	0.01 ... 3	0.01 ... 3	0.01 ... 1	0.01 ... 0.6	0.01 ... 3
Operational current of the auxiliary contacts						
• At AC-15						
- At 24 V	A	3	3	1	--	3
- At 250 V	A	3	3	1	--	3
- At 400 V	A	--	3	--	--	--
• At DC-12						
- At 24 V	A	--	--	1	--	--
- At 125 V	A	--	--	1	--	--
- At 250 V	A	--	--	1	--	--
• At DC-13						
- At 24 V	A	1	1	--	--	1
- At 125 V	A	0.2	0.2	--	--	0.2
- At 250 V	A	0.1	0.1	--	--	0.1
Thermal current	A	5	5	1	0.6	5
Mechanical endurance (operating cycles)		10 000 000				
Electrical endurance (operating cycles) for AC-15 at 230 V		100 000		300 000	100 000	

Article number	3RP25...-1...0	3RP25...-2...0
Type of electrical connection for auxiliary and control circuits	Screw terminals	Spring-type terminals (push-in)
Design of thread of connection screw	M3	--
Tightening torque	Nm 0.6 ... 0.8	--
Type of connectable conductor cross-sections		
• Solid	1x (0.5 ... 4 mm ²), 2x (0.5 ... 2.5 mm ²)	1x (0.5 ... 4 mm ²)
• Finely stranded with end sleeve	1x (0.5 ... 4 mm ²), 2x (0.5 ... 1.5 mm ²)	1x (0.5 ... 2.5 mm ²)
• For AWG cables		
- Solid	1x (20 ... 12), 2x (20 ... 14)	1x (20 ... 12)
- Stranded	1x (20 ... 12), 2x (20 ... 14)	1x (20 ... 12)

Relays

Timing Relays

SIRIUS 3RP25 timing relays, 17.5 mm and 22.5 mm

3RP25 function diagrams

Multifunction 3RP2505-.A, 1 CO, 13 functions and 3RP2505-.C, 1 NO (semiconductor), 13 functions

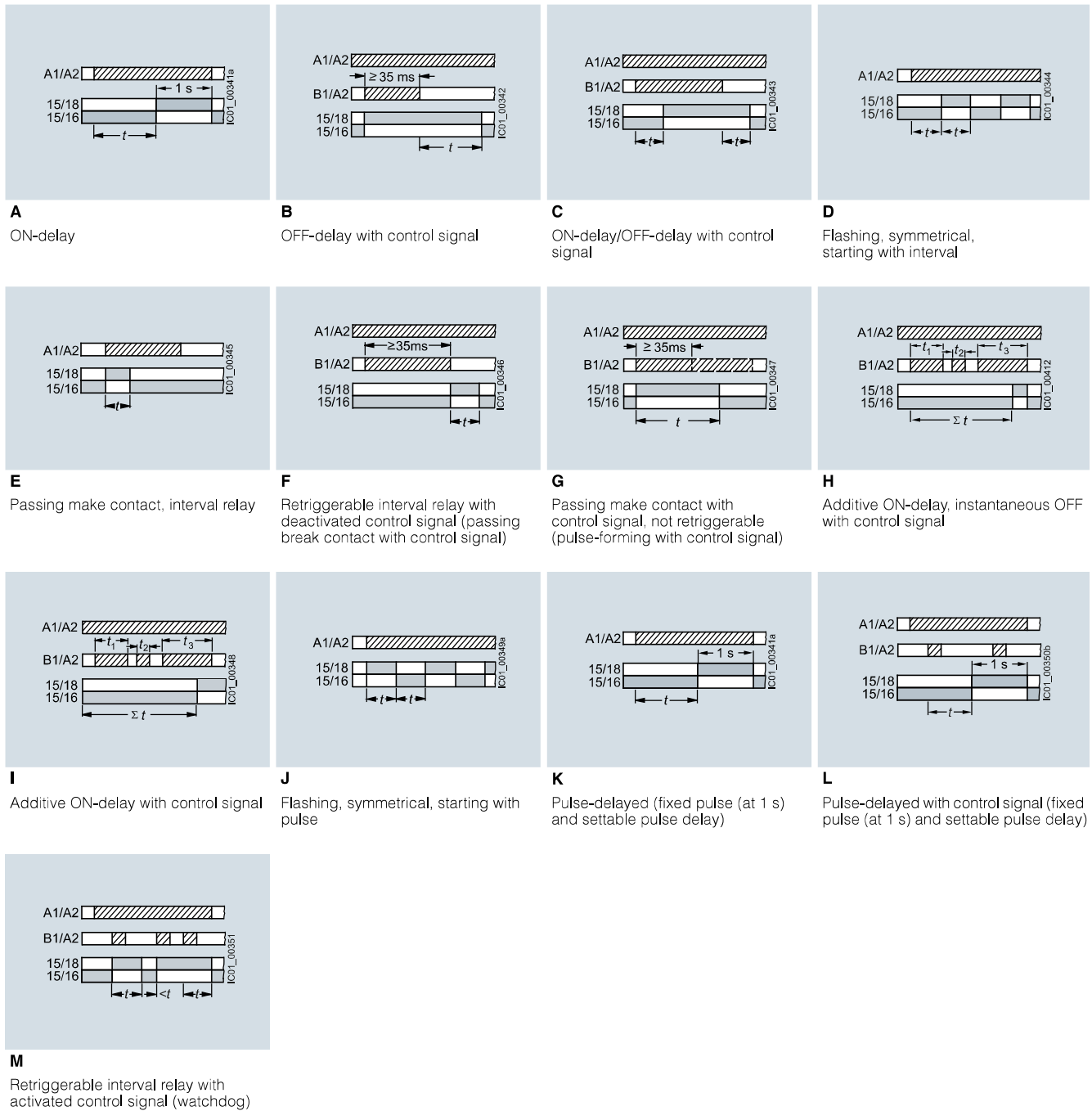

Legend

- A ... M** Identification letters
- Timing relay energized
- Contact closed
- Contact open

SIRIUS 3RP25 timing relays, 17.5 mm and 22.5 mm

Multifunction 3RP2505-.B, 13 functions, 2 CO positively driven and switched in parallel with delay

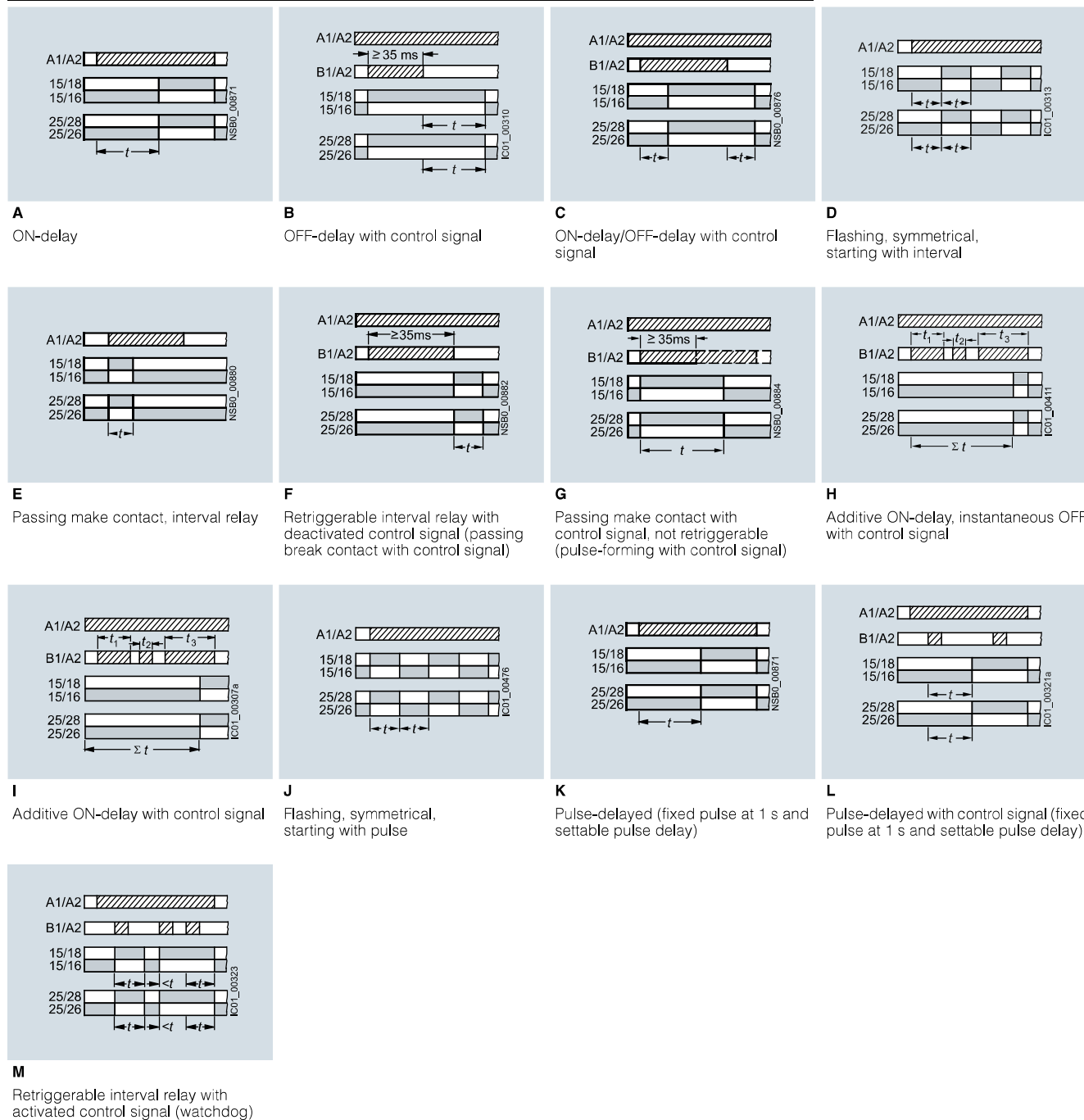

Legend

- A ... M** Identification letters
- Timing relay energized
- Contact closed
- Contact open

Relays

Timing Relays

SIRIUS 3RP25 timing relays, 17.5 mm and 22.5 mm

Multifunction 3RP2505-.B, 27 functions, 2 CO

<p>A</p> <p>2 CO contacts switched in parallel</p> <p>ON-delay</p>	<p>1 delayed CO contact + 1 instantaneous CO contact</p> <p>ON-delay and instantaneous contact</p>	<p>B</p> <p>2 CO contacts switched in parallel</p> <p>OFF-delay with control signal</p>	<p>1 delayed CO contact + 1 instantaneous CO contact</p> <p>OFF-delay with control signal and instantaneous contact</p>
<p>C</p> <p>2 CO contacts switched in parallel</p> <p>ON-delay/OFF-delay with control signal</p>	<p>1 delayed CO contact + 1 instantaneous CO contact</p> <p>ON-delay/OFF-delay with control signal and instantaneous contact</p>	<p>D</p> <p>2 CO contacts switched in parallel</p> <p>Flashing, symmetrical, starting with interval</p>	<p>1 delayed CO contact + 1 instantaneous CO contact</p> <p>Flashing, symmetrical, starting with interval and instantaneous contact</p>
<p>E</p> <p>2 CO contacts switched in parallel</p> <p>Passing make contact, interval relay</p>	<p>1 delayed CO contact + 1 instantaneous CO contact</p> <p>Passing make contact, interval relay and instantaneous contact</p>	<p>F</p> <p>2 CO contacts switched in parallel</p> <p>Retriggerable interval relay with deactivated control signal (passing break contact with control signal)</p>	<p>1 delayed CO contact + 1 instantaneous CO contact</p> <p>Retriggerable interval relay with deactivated control signal (passing break contact with control signal) and instantaneous contact</p>
<p>G</p> <p>2 CO contacts switched in parallel</p> <p>Passing make contact with control signal, not retriggerable (pulse-forming with control signal)</p>	<p>1 delayed CO contact + 1 instantaneous CO contact</p> <p>Passing make contact with control signal, not retriggerable (pulse-forming with control signal) and instantaneous contact</p>	<p>H</p> <p>2 CO contacts switched in parallel</p> <p>Additive ON-delay, instantaneous OFF with control signal</p>	<p>1 delayed CO contact + 1 instantaneous CO contact</p> <p>Additive ON-delay, instantaneous OFF with control signal and instantaneous contact</p>

Legend

- A ... H** Identification letters
- Timing relay energized
- Contact closed
- Contact open

SIRIUS 3RP25 timing relays, 17.5 mm and 22.5 mm

Multifunction 3RP2505-.B, 27 functions, 2 CO contacts (continued)

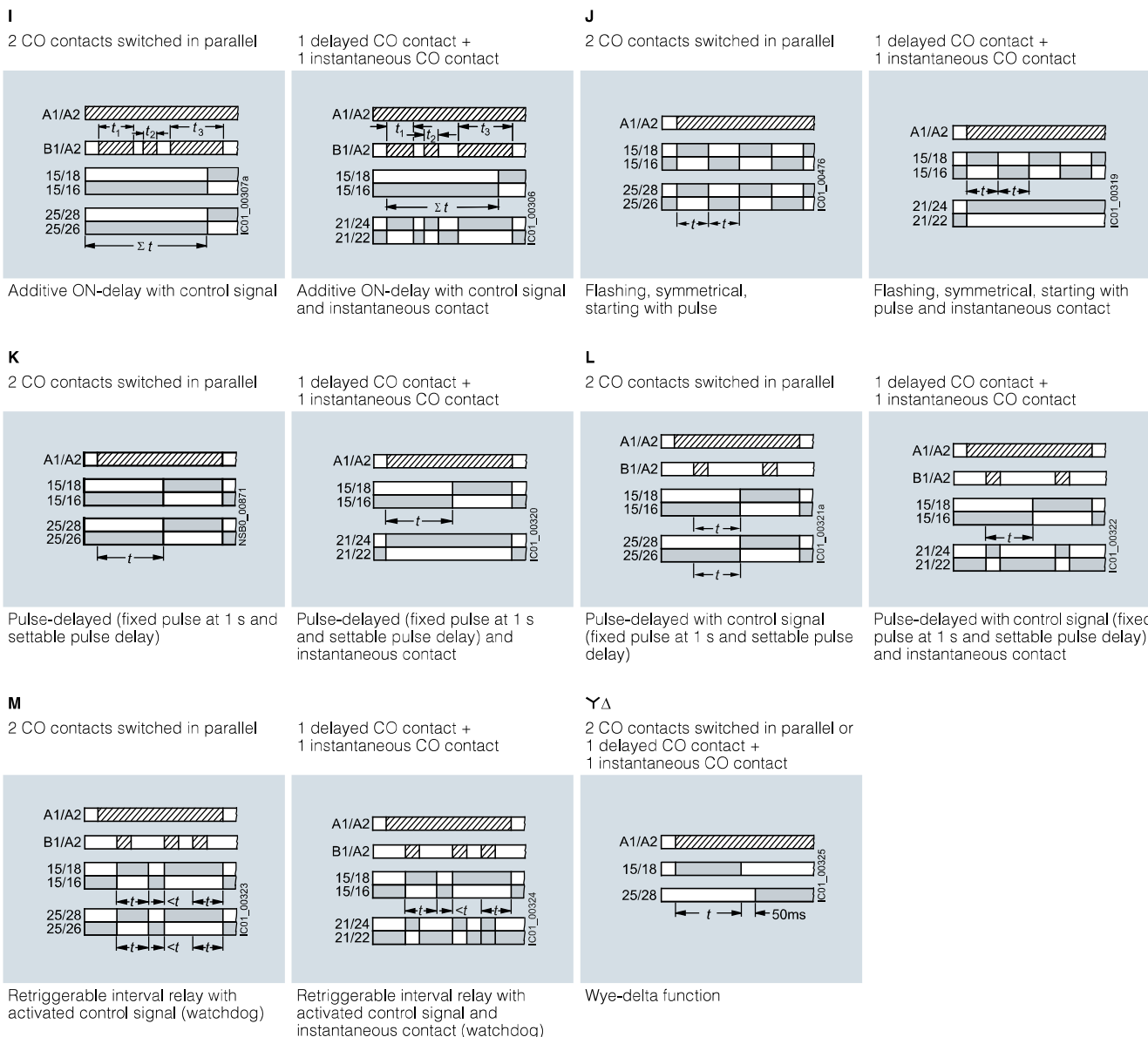

Legend

- I ... M Identification letters
- ▨ Timing relay energized
- Contact closed
- Contact open

Relays

Timing Relays

SIRIUS 3RP25 timing relays, 17.5 mm and 22.5 mm

Monofunctions 3RP251. to 3RP257.¹⁾

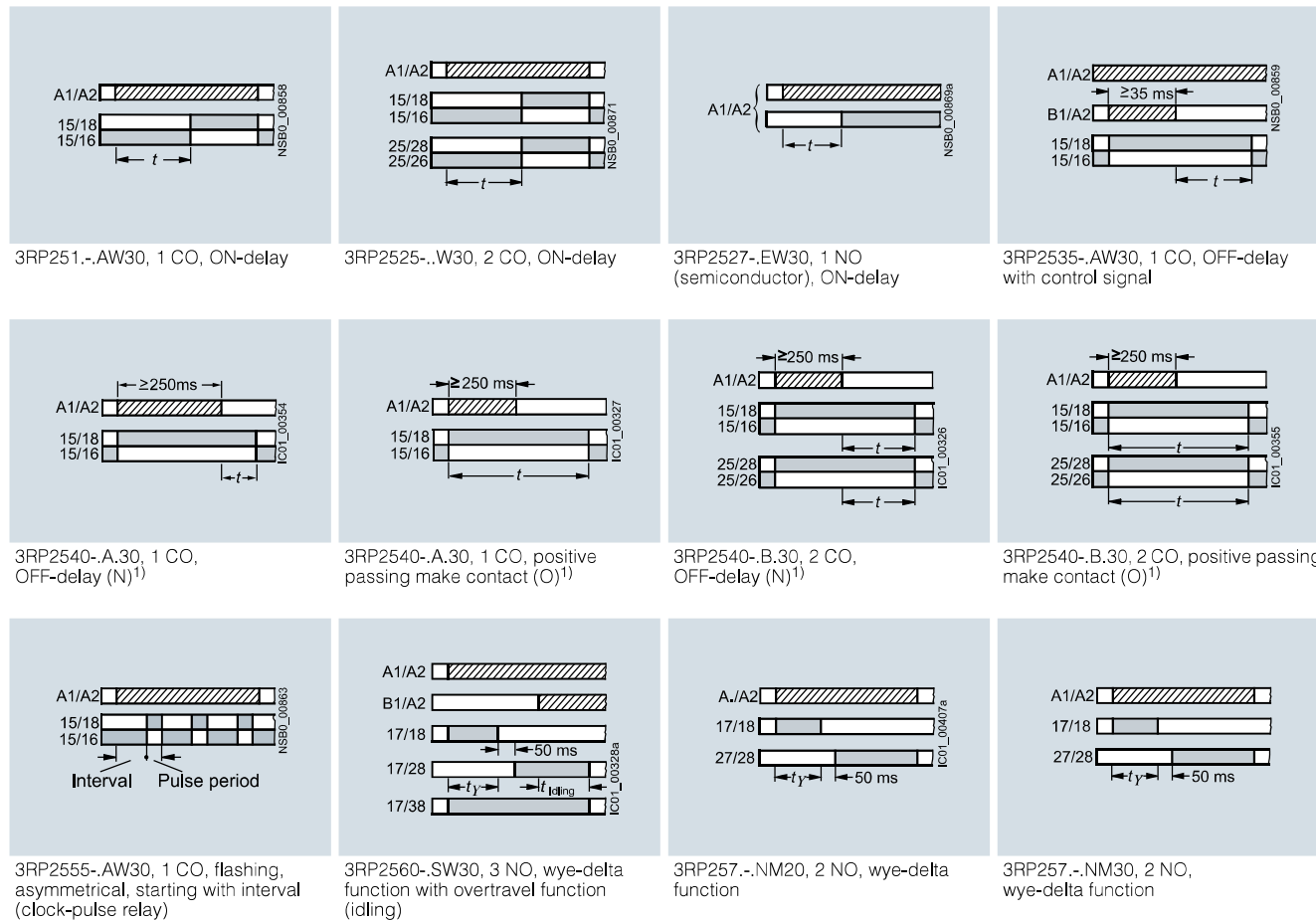

Legend

- Timing relay energized
- Contact closed
- Contact open

¹⁾ 3RP2540 has a double function:
 Function N = OFF-delay
 Function O = Positive passing make contact

Possibilities of operation of the 3RP2560-.SW30 timing relay

Operation 1: Start contact B./A2 is open when control supply voltage A./A2 is applied

The control supply voltage is applied to A./A2 and there is no control signal on B./A2. This starts the $\Upsilon\Delta$ timing. The idling time (coasting time) is started by applying a control signal to B./A2. When the set time t_{idling} (30 ... 600 s) has elapsed, the output relays (17/38 and 17/28) are reset. If the control signal on B./A2 is switched off (minimum OFF period 270 ms), a new timing is started.

Note:

Observe response time (dead time) of 400 ms on energizing control supply voltage until contacts 17/18 and 17/38 close.

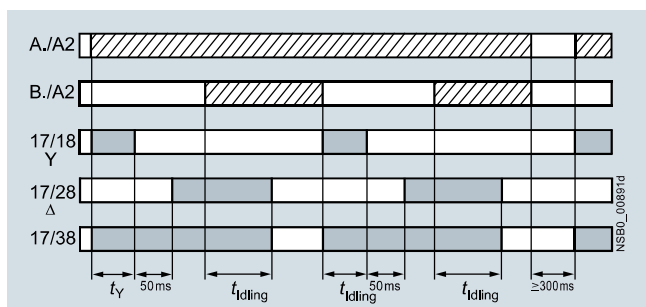

Operation 1

Operation 2: Start contact B./A2 is closed when control supply voltage A./A2 is applied

If the control signal B./A2 is already present when the control supply voltage A./A2 is applied, **no** timing is started. The timing is only started when the control signal B./A2 is switched off.

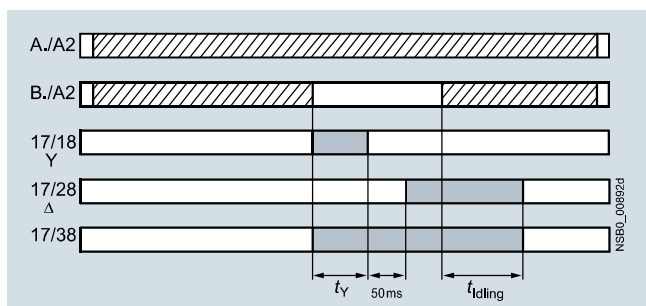

Operation 2

Operation 3: Start contact B./A2 closes while star time is running

If the control signal B./A2 is applied again during the star time, the idling time starts and the timing is terminated normally.

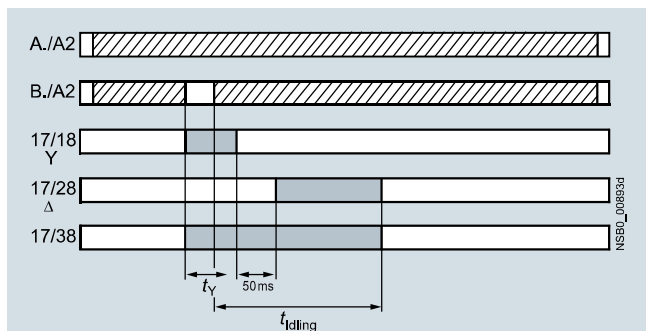

Operation 3

Operation 4: Start contact B./A2 opens while delta time is running and is applied again

If the control signal on B./A2 is applied and switched off again during the delta time, although the idling time has not yet elapsed, the idling time (coasting time) is reset to zero. If the control signal is re-applied to B./A2, the idling time is restarted.

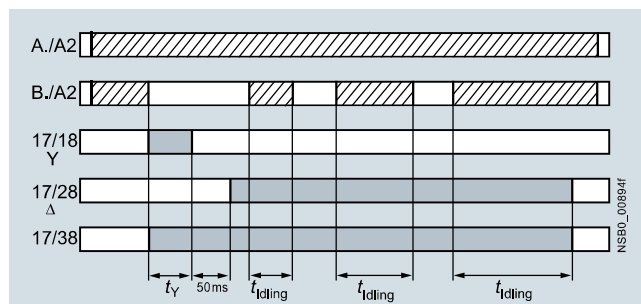

Operation 4

Legend

▨ Timing relay energized

■ Contact closed

□ Contact open

t_Y = Star time 1 ... 20 s

t_{idling} = Idling time (coasting time) 30 ... 600 s

Note:

The following applies to all operations: The pressure switch controls the timing via B./A2.

Application example based on standard operation (operation 1):
For example, use of 3RP2560 for compressor control

Frequent starting of compressors strains the network, the machine, and the increased costs for the operator. The new timing relay prevents frequent starting at times when there is high demand for compressed air. A special control circuit prevents the compressor from being switched off immediately when the required air pressure in the tank has been reached. Instead, the valve in the intake tube is closed and the compressor runs in "Idling" mode, i.e. in no-load operation for a specific time which can be set from 30 ... 600 s.

If the pressure falls within this time, the motor does not have to be restarted again, but can return to nominal load operation from no-load operation.

If the pressure does not fall within this idling time, the motor is switched off.

The pressure switch controls the timing via B./A2.

The control supply voltage is applied to A./A2 and the start contact B./A2 is open, i.e. there is no control signal on B./A2 when the control supply voltage is applied. The pressure switch signals "too little pressure in system" and starts the timing by way of terminal B./A2. The compressor is started, enters $\Upsilon\Delta$ operation, and fills the pressure tank.

When the pressure switch signals "sufficient pressure", the control signal B./A2 is applied, the idling time (coasting time) is started, and the compressor enters no-load operation for the set period of time from 30 ... 600 s. The compressor is then switched off. The compressor is only restarted if the pressure switch responds again (low pressure).

Relays

Timing Relays

SIRIUS 3RP25 timing relays, 17.5 mm and 22.5 mm

Selection and ordering data



3RP2505-2AB30



3RP2505-2BB30



3RP2525-2AW30



3RP2540-2AW30



3RP2555-2AW30



3RP2576-2NW30

Number of NO contacts		Number of CO contacts		Semi-conductor output	Adjustable time	Control supply voltage		SD	Article No.	Price per PU	PU (UNIT, SET, M)	PS*	PG
Instantaneous switching	Delayed switching	Instantaneous switching	Delayed switching			At 50/60 Hz AC	At DC						
						V	V	d					
13 functions													
0	0	0	1	No	0.05 s ... 100 h	24	24	2	3RP2505-□AB30		1	1 unit	41H
						12 ... 240	12 ... 240	2	3RP2505-□AW30		1	1 unit	41H
0	1	0	0	Yes	0.05 s ... 100 h	12 ... 240	12 ... 240	2	3RP2505-□CW30		1	1 unit	41H
13 functions, suitable for railway applications													
0	0	0	2 ¹⁾	No	0.05 s ... 100 h	24 ... 240	24 ... 240	2	3RP2505-□RW30		1	1 unit	41H
27 functions													
0	0	0	2 ²⁾	No	0.05 s ... 100 h	24	24	2	3RP2505-□BB30		1	1 unit	41H
						400 ... 440	--	2	3RP2505-□BT20		1	1 unit	41H
						12 ... 240	12 ... 240	2	3RP2505-□BW30		1	1 unit	41H
ON-delay													
0	0	0	1	No	0.5 ... 10 s	12 ... 240	12 ... 240	2	3RP2511-□AW30		1	1 unit	41H
					1 ... 30 s	12 ... 240	12 ... 240	2	3RP2512-□AW30		1	1 unit	41H
					5 ... 100 s	12 ... 240	12 ... 240	2	3RP2513-□AW30		1	1 unit	41H
					0.05 s ... 100 h	12 ... 240	12 ... 240	2	3RP2525-□AW30		1	1 unit	41H
0	0	0	2	No	0.05 s ... 100 h	24	24	2	3RP2525-□BB30		1	1 unit	41H
						12 ... 240	12 ... 240	2	3RP2525-□BW30		1	1 unit	41H
0	1	0	0	Yes	0.05 s ... 240 s	12 ... 240	12 ... 240	2	3RP2527-□EW30		1	1 unit	41H
OFF-delay with control signal													
0	0	0	1	No	0.05 s ... 100 h	12 ... 240	12 ... 240	2	3RP2535-□AW30		1	1 unit	41H
OFF-delay without control signal, non-volatile, passing make contact													
0	0	0	1	No	0.05 s ... 600 s	24	24	2	3RP2540-□AB30		1	1 unit	41H
						12 ... 240	12 ... 240	2	3RP2540-□AW30		1	1 unit	41H
0	0	0	2	No	0.05 s ... 600 s	24	24	2	3RP2540-□BB30		1	1 unit	41H
						12 ... 240	12 ... 240	2	3RP2540-□BW30		1	1 unit	41H
Clock-pulse relay, flashing, asymmetrical													
0	0	0	1	No	0.05 s ... 100 h	12 ... 240	12 ... 240	2	3RP2555-□AW30		1	1 unit	41H
Wye-delta function with coasting function (idling)													
1	2	0	0	No	1 ... 20 s	12 ... 240	12 ... 240	2	3RP2560-□SW30		1	1 unit	41H
Wye-delta function													
1	1	0	0	No	1 ... 20 s	380 ... 440 ³⁾	--	2	3RP2574-□NM20		1	1 unit	41H
						12 ... 240	12 ... 240	2	3RP2574-□NW30		1	1 unit	41H
1	1	0	0	No	3 ... 60 s	380 ... 440 ³⁾	--	2	3RP2576-□NM20		1	1 unit	41H
						12 ... 240	12 ... 240	2	3RP2576-□NW30		1	1 unit	41H

Type of electrical connection

- Screw terminals
- Spring-type terminals (push-in)

1) Positively-driven contacts.

2) Optionally 1 CO delayed + 1 CO instantaneous.

3) With 3RP2574-.NM20 and 3RP2576-.NM20, connection of 200 ... 240 V AC, 50/60 Hz control voltage is also possible.

Notes:

For accessories, see page 10/49.

In the case of 3RP2505, the functions can be adjusted by means of function selector switches on the device. With a set of foil labels the timing relay can be legibly marked with the functions which can be selected on the timing relay. This is included in the scope of supply. The same potential must be applied to terminals A, and B.

For functions, see the overview of functions on page 10/39.







1
2

SIRIUS 3RP25 timing relays, 17.5 mm and 22.5 mm

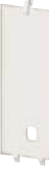
Accessories

More information

You can find information on configuring and dimensioning the accessories in the manual, see <https://support.industry.siemens.com/cs/ww/en/view/103532830>

Version	SD	Article No.	Price per PU	PU (UNIT, SET, M)	PS*	PG
Accessories for enclosures						
		Sealing covers • 17.5 mm				
3ZY1321-1AA00	2	3ZY1321-1AA00		1	5 units	41L
		• 22.5 mm				
3ZY1321-2AA00	2	3ZY1321-2AA00		1	5 units	41L
		Push-in lugs For wall mounting				
3ZY1311-0AA00	2	3ZY1311-0AA00		1	10 units	41L
		Coding pins For removable terminals of SIRIUS devices in the industrial standard mounting rail enclosure; they enable the mechanical coding of terminals				
3ZY1440-1AA00	2	3ZY1440-1AA00		1	12 units	41L
Terminals for SIRIUS devices in the industrial standard mounting rail enclosure						
		Removable terminals • 2-pole, 1 x 4 mm²	Screw terminals 			
3ZY1122-1BA00	2	3ZY1122-1BA00		1	6 units	41L
		• 2-pole, 1 x 4 mm²	Spring-type terminals (push-in) 			
3ZY1122-2BA00	2	3ZY1122-2BA00		1	6 units	41L
Tools for opening spring-type terminals						
		Screwdrivers For all SIRIUS devices with spring-type terminals; 3.0 mm x 0.5 mm; length approx. 200 mm, titanium gray/black, partially insulated	Spring-type terminals (push-in) 			
3RA2908-1A	2	3RA2908-1A		1	1 unit	41B

Relays

Timing Relays

SIRIUS 3RP20 timing relays, 45 mm

Overview

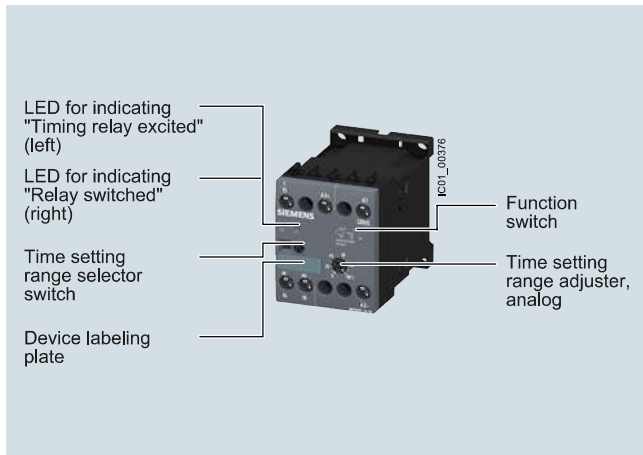

SIRIUS 3RP20 timing relays

SIRIUS 3RP20 electronic timing relays for use in control systems and mechanical engineering with:

- 1 or 2 CO contacts
- Multifunction or monofunction
- Wide voltage range or combination voltage
- Single or selectable time setting ranges
- Switch position indication and voltage indication by LED

Standards

The timing relays comply with:

- IEC 60721-3-3 "Classification of environmental conditions"
- IEC 61812-1 "Specified time relays for industrial use"
- IEC 61000-6-2 and EN 61000-6-4 "Electromagnetic compatibility"
- IEC 60947-5-1 "Low-voltage switchgear and controlgear – Electromechanical control circuit devices"
- IEC 60947-1, Appendix N "Protective separation"

Multifunction

The functions of the 3RP2005 multifunctional timing relays can be set by means of the function selector switch. Insert labels can be used to adjust different functions of the timing relay clearly and unmistakably. The corresponding labels can be ordered as an accessory. The same potential must be applied to terminals A. and B.

For functions, see 3RP2901 label set, page 10/55.

Note:

The activation of loads parallel to the start input is not permissible when using AC control voltage (see diagrams).

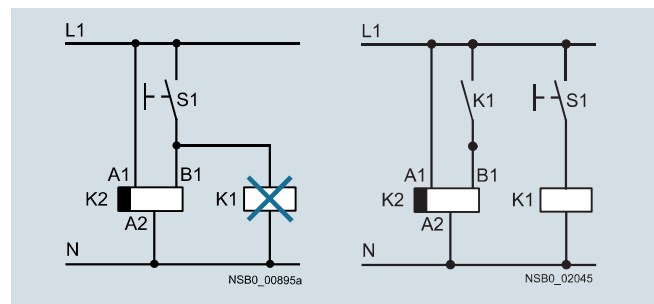

Diagrams

Accessories

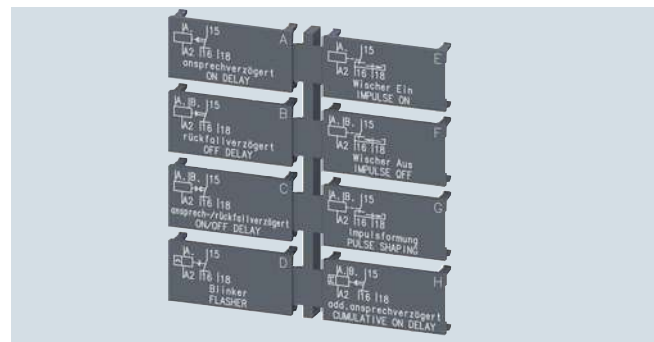

Label set for marking the multifunctional relay

Article No. scheme

Product versions		Article number			
SIRIUS timing relays, 45 mm enclosure		3RP20	<input type="checkbox"/>	<input type="checkbox"/>	3 0
Product function/ time setting ranges	Multifunction	0 5			15 time ranges 0.05 s... 100 h
	ON-delay	2 5			15 time ranges 0.05 s... 100 h
Connection type	Screw terminals			1	
	Spring-type terminals			2	
Contacts	1 CO				A
	2 CO				B
Control supply voltage	24 V AC/DC/100 ... 127 V AC				Q Combination voltage
	24 V AC/DC/200 ... 240 V AC				P Combination voltage
	24 ... 240 V AC/DC				W Wide voltage range
Example		3RP20	0 5	- 1 A P 3 0	

Note:

The Article No. scheme shows an overview of product versions for better understanding of the logic behind the article numbers.

For your orders, please use the article numbers quoted in the selection and ordering data.



Benefits

- Suitable for 3RT miniature contactors
- Uniform design
- Ideal for small distance between standard mounting rails and/or for low mounting depth, e.g. in control boxes
- Labels are used on the multifunctional time relay to document the function that has been set

Application

Timing relays are used in control, starting, and protective circuits for all switching operations involving time delays. They guarantee a high level of functionality and a high repeat accuracy of timer settings.

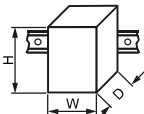
Technical specifications

More information		
Technical specifications, see https://support.industry.siemens.com/cs/ww/en/ps/16356/td Operating Instructions, see https://support.industry.siemens.com/cs/ww/en/view/11647144	Internal circuit diagrams, see https://support.industry.siemens.com/cs/ww/en/view/11647144 FAQs, see https://support.industry.siemens.com/cs/ww/en/ps/16356/faq	
Type		3RP2005, 3RP2025
Dimensions (W x H x D)	 mm	45 x 57 x 73
Rated insulation voltage Pollution degree 3 Overvoltage category III	V AC	300
Permissible ambient temperature • During operation • During storage	°C °C	-25 ... +60 -40 ... +85
Operating range of excitation¹⁾		0.85 ... 1.1 x U_N at AC; 0.8 ... 1.25 x U_N at DC; 0.95 ... 1.05 times the rated frequency
Mechanical endurance	Operating cycles	10 x 10 ⁶
Electrical endurance at I_e	Operating cycles	1 x 10 ⁵
Connection type		 Screw terminals
• Terminal screw • Solid • Finely stranded with end sleeve • Stranded • AWG cables • Tightening torque	mm ² mm ² AWG AWG Nm	M3 (for standard screwdriver, size 2 and Pozidriv 2) 2 x (0.5 ... 1.5) ²⁾ , 2 x (0.75 ... 2.5) ²⁾ 2 x (0.5 ... 1.5) ²⁾ , 2 x (0.75 ... 2.5) ²⁾ 2 x (0.5 ... 1.5) ²⁾ , 2 x (0.75 ... 2.5) ²⁾ 2 x (18 ... 14) 0.8 ... 1.2
Connection type		 Spring-type terminals
• Solid • Finely stranded with end sleeve • Finely stranded without end sleeve • AWG cables, solid or stranded • Max. external diameter of the conductor insulation	mm ² mm ² mm ² AWG mm	2 x (0.25 ... 2.5) 2 x (0.25 ... 1.5) 2 x (0.25 ... 2.5) 2 x (24 ... 14) 3.6

¹⁾ If nothing else is stated.

²⁾ If two different conductor cross-sections are connected to one clamping point, both cross-sections must lie in one of the ranges specified.

Relays

Timing Relays

SIRIUS 3RP20 timing relays, 45 mm

3RP20 function diagrams and 3RP2901 label set

1 CO contact

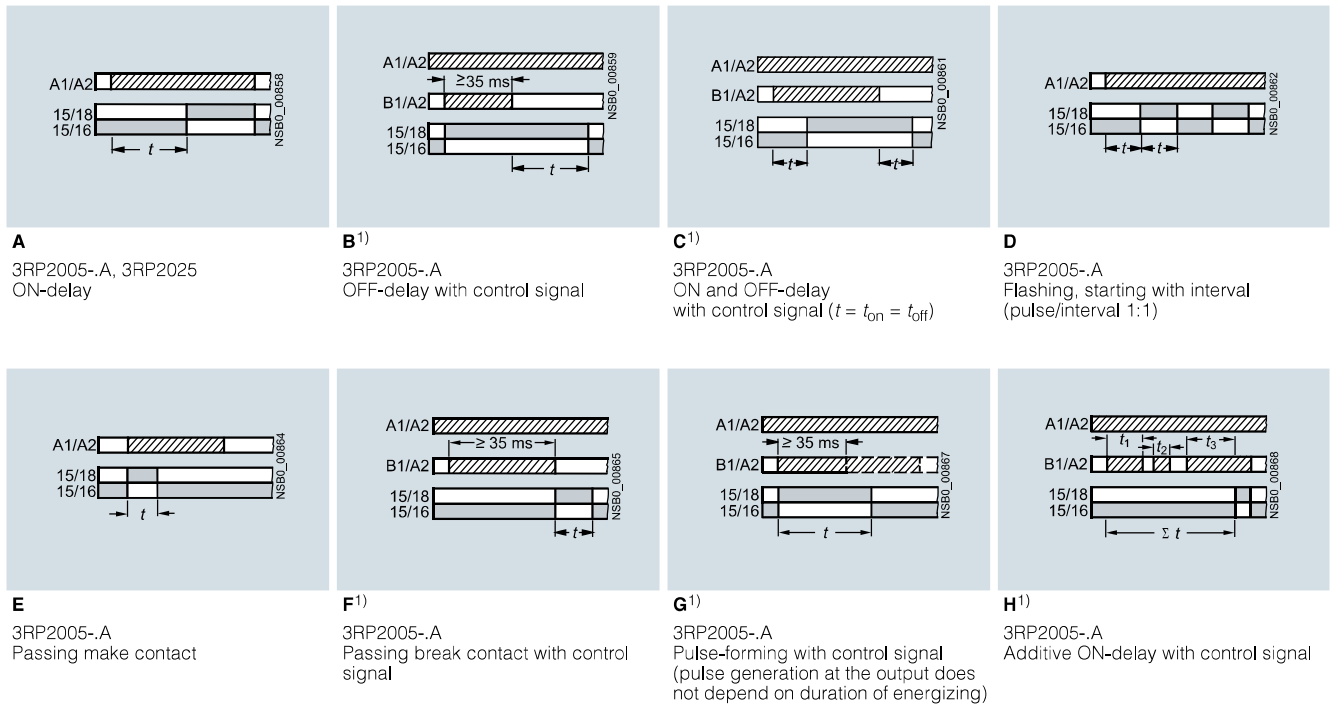

Legend

A ... H Identification letters for 3RP2005

- Timing relay energized
- Contact closed
- Contact open

¹⁾ Note on function with start contact: A new control signal at terminal B, after the operating time has started, resets the operating time to zero (retriggerable). This does not apply to G, G● and H●, which are not retriggerable.

2 CO contacts

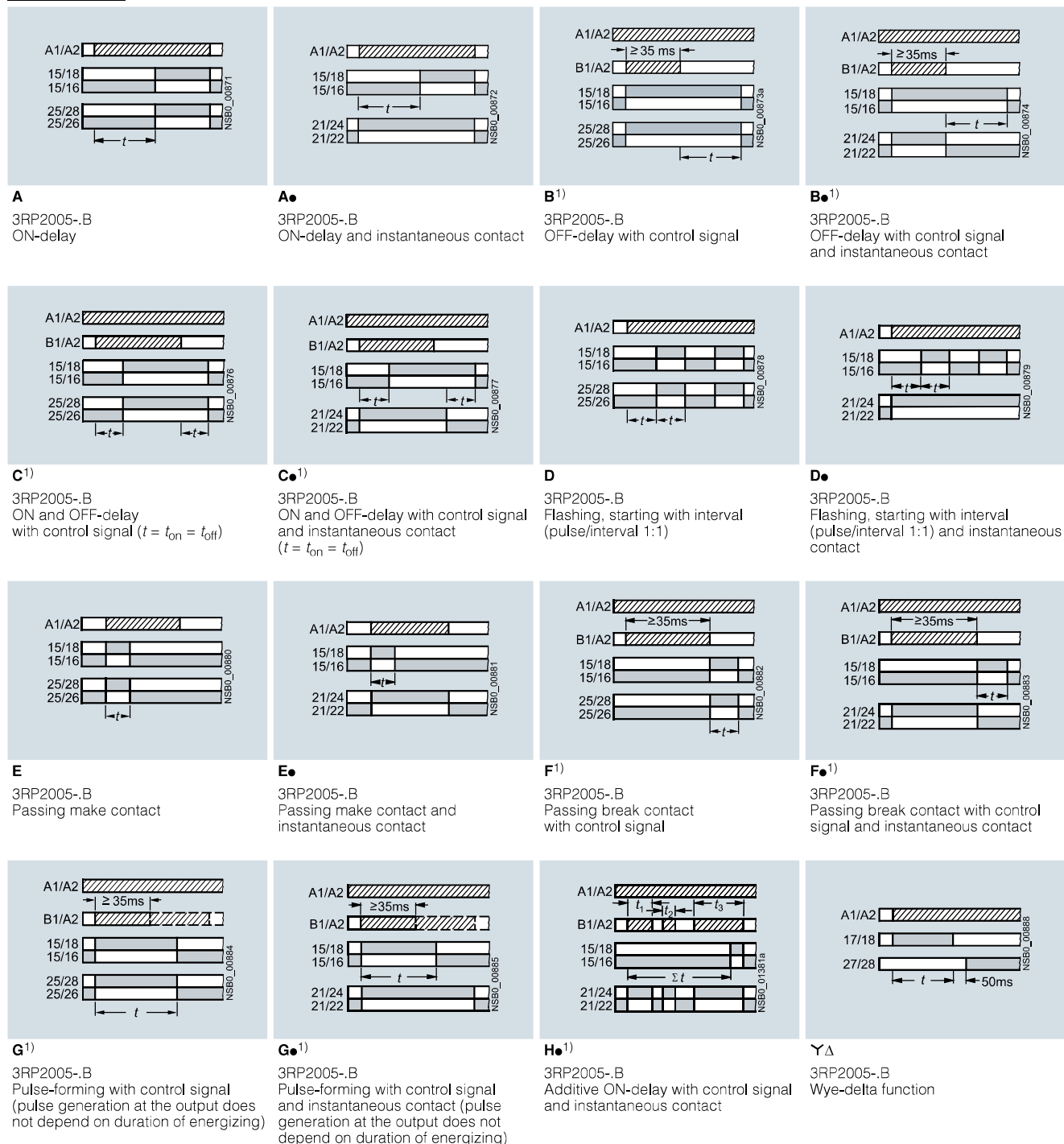

Legend

A ... H Identification letters for 3RP2005

- ▨ Timing relay energized
- Contact closed
- Contact open

¹⁾ Note on function with start contact: A new control signal at terminal B, after the operating time has started, resets the operating time to zero (retriggerable). This does not apply to G, G● and H●, which are not retriggerable.

Relays

Timing Relays

SIRIUS 3RP20 timing relays, 45 mm

Selection and ordering data

PU (UNIT, SET, M) = 1
 PS* = 1 unit
 PG = 41H



3RP2005-1AP30



3RP2005-1BW30



3RP2005-2AP30





3RP2025-2BW30

Version	Time setting range t	Rated control supply voltage U_s		SD	Screw terminals	SD	Spring-type terminals
		50/60 Hz AC	DC				
		V	V	d	Article No.	Price per PU	Article No.
					d		Price per PU
3RP2005 timing relays, multifunction, 15 time setting ranges							
The functions can be adjusted by means of rotary switches. Insert labels can be used to adjust different functions of the 3RP2005 timing relay clearly and unmistakably. The corresponding labels can be ordered as an accessory. The same potential must be applied to terminals A. and B. For functions, see 3RP2901 label set, page 10/55.							
With LED and 1 CO contact ¹⁾ , 8 functions	0.05 ... 1 s 0.15 ... 3 s 0.5 ... 10 s	24/100 ... 127 24/200 ... 240	24 24	▶	3RP2005-1AQ30 3RP2005-1AP30	2	3RP2005-2AQ30 3RP2005-2AP30
With LED and 2 CO contacts, 16 functions	1.5 ... 30 s 0.05 ... 1 min 5 ... 100 s 0.15 ... 3 min 0.5 ... 10 min 1.5 ... 30 min 0.05 ... 1 h 5 ... 100 min 0.15 ... 3 h 0.5 ... 10 h 1.5 ... 30 h 5 ... 100 h ∞ ²⁾	24 ... 240 ³⁾	24 ... 240 ⁴⁾	▶	3RP2005-1BW30	2	3RP2005-2BW30
3RP2025. timing relays, ON-delay, 15 time setting ranges							
With LED and 1 CO contact ¹⁾	0.05 ... 1 s 0.15 ... 3 s 0.5 ... 10 s 1.5 ... 30 s 0.05 ... 1 min 5 ... 100 s 0.15 ... 3 min 0.5 ... 10 min 1.5 ... 30 min 0.05 ... 1 h 5 ... 100 min 0.15 ... 3 h 0.5 ... 10 h 1.5 ... 30 h 5 ... 100 h ∞ ²⁾	24/100 ... 127 24/200 ... 240	24 24	▶	3RP2025-1AQ30 3RP2025-1AP30	▶	3RP2025-2AQ30 3RP2025-2AP30

For accessories, see page 10/55.

- 1) Units with protective separation.
- 2) With ∞ switch position no timing. For test purposes (ON/OFF function) on site. Relay is constantly on when activated, or relay remains constantly off when activated. Depending on which function is set.
- 3) Operating range 0.8 to 1.1 x U_s .
- 4) Operating range 0.7 to 1.1 x U_s .

Accessories

Version	Function	Identifi- cation letter	Use	SD	Article No.	Price per PU	PU (UNIT, SET, M)	PS*	PG
Label sets for 3RP20									
Accessories for 3RP20 (not included in the scope of supply). The label set can be used to label timing relays with the set function in English and German.									
 3RP2901-0A	1 label set (1 unit) with 8 functions	<ul style="list-style-type: none"> • ON-delay • OFF-delay with control signal • ON-delay and OFF-delay with control signal • Flashing, starting with interval • Passing make contact • Passing break contact with control signal • Pulse-forming with control signal • Additive ON-delay with control signal 	A B C D E F G H	For devices with 1 CO	10	3RP2901-0A	1	5 units	41H
	 3RP2901-0B	1 label set (1 unit) with 16 functions	<ul style="list-style-type: none"> • ON-delay • OFF-delay with control signal • ON-delay and OFF-delay with control signal • Flashing, starting with interval • Passing make contact • Passing break contact with control signal • Pulse-forming with control signal • ON-delay and instantaneous contact • OFF-delay with control signal and instantaneous contact • ON-delay and OFF-delay with control signal and instantaneous contact • Flashing, starting with interval, and instantaneous contact • Passing make contact and instantaneous contact • Passing break contact with control signal and instantaneous contact • Pulse-forming with control signal and instantaneous contact • Additive ON-delay with control signal and instantaneous contact • Wye-delta function 	A B C D E F G A• B• C• D• E• F• G• H• YΔ	For devices with 2 CO	10	3RP2901-0B	1	5 units
Blank inscription labels for 3RP20									
	Blank inscription labels, 20 mm x 7 mm, pastel turquoise ¹⁾		For 3RP20	20	3RT1900-1SB20		100	340 units	41B

¹⁾ PC labeling system for individual inscription
of unit labeling plates available from:
Conta-Clip Verbindungstechnik GmbH,
see page 16/15.

Relays

Timing Relays

7PV15 timing relays, 17.5 mm

Overview



7PV15 timing relay

Electronic timing relays for general use and in control systems, mechanical engineering and infrastructure with:

- 1 or 2 CO contacts
- Multifunction or monofunction
- Wide voltage range or combination voltage
- Single or selectable time setting ranges
- Switch position indication and voltage indication by LED

Standards

The timing relays comply with:

- IEC 60721-3-3 "Classification of environmental conditions"
- IEC 61812-1 "Specified time relays for industrial use"
- IEC 61000-6-2 and EN 61000-6-4 "Electromagnetic compatibility"
- IEC 60947-5-1 "Low-voltage switchgear and controlgear – Electromechanical control circuit devices"
- DIN 43880 "Built-in equipment for electrical installations; overall dimensions and related mounting dimensions"

Multifunction

The functions of the 7PV1508-1A multifunctional timing relay can be set by means of rotary switches. The identification letters A to G are printed on the front alongside the rotary selector switch of the unit. The related function can be found in the form of a bar graph on the side of the device.

Enclosure version

All timing relays are suitable for snap-on mounting onto TH 35 standard mounting rails according to IEC 60715. The enclosure complies with DIN 43880, 1 MW.

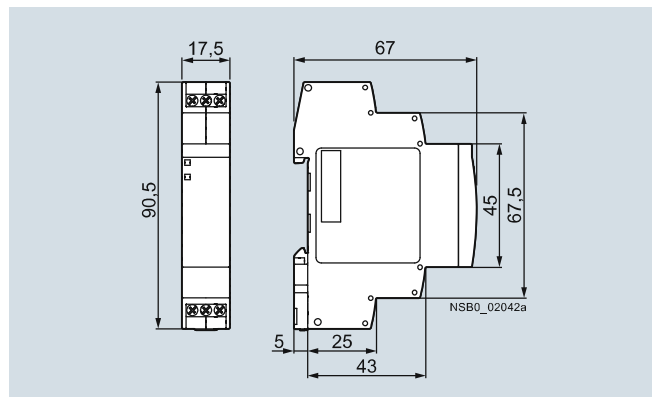

Dimensions

Note:

The activation of loads parallel to the start input is not permissible when using AC control voltage (see diagrams).

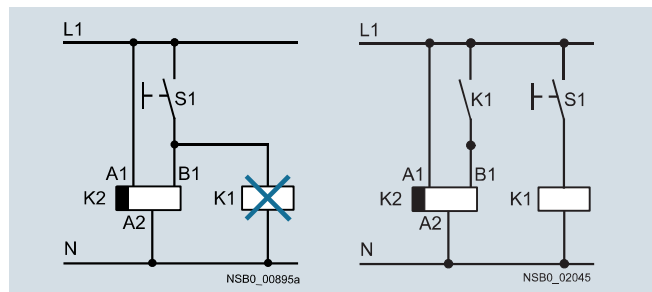

Diagrams

Article No. scheme

Product versions		Article number	
Timing relays in industrial enclosure, 17.5 mm		7PV15	□ □ - 1 □ □ 3 0
Product function/ time setting ranges	Multifunction ON-delay	0 8	7 time ranges 0.05 s ... 100 h
		1 1	1 time range 0.05 ... 1 s
		1 2	1 time range 0.5 ... 10 s
		1 3	1 time range 5 ... 100 s
		1 8	7 time ranges 0.05 s ... 100 h
	OFF-delay with control signal	3 8	7 time ranges 0.05 s ... 100 h
	OFF-delay without control signal	4 0	7 time ranges 0.05 s ... 100 s
	Clock-pulse relay	5 8	7 time ranges 0.05 s ... 100 h
	Wye-delta function	7 8	7 time ranges 0.05 s ... 100 h
Contacts	e.g. A = 1 CO contact		<input type="checkbox"/>
Control supply voltage	e.g. W = 12 ... 240 V AC/DC		<input type="checkbox"/> Combination voltage
Example		7PV15 0 8 - 1 A W 3 0	

Note:

The Article No. scheme shows an overview of product versions for better understanding of the logic behind the article numbers.

For your orders, please use the article numbers quoted in the selection and ordering data.

Benefits

- Wide voltage range 12 to 240 V AC/DC
- High switching capacity, e.g. AC-15 at 230 V, 3 A
- Combination voltage, e.g. 24 V AC/DC and 200 to 240 V AC
- Changes to the time setting range during operation
- Changes to the function in the de-energized state
- High level of functionality and a high repeat accuracy of timer settings
- Integrated surge suppressor
- Function charts printed on the side of the device for reliable device adjustment

Application

Timing relays are used in control, starting, and protective circuits for all switching operations involving time delays,

e.g. in functional buildings, airports, building industry, etc.

Technical specifications

More information	
Technical specifications, see https://support.industry.siemens.com/cs/ww/en/ps/16358/td	Operating instructions and internal circuit diagrams, see https://support.industry.siemens.com/cs/ww/en/view/35210295
Type	7PV15
Rated insulation voltage Pollution degree 2, overvoltage category III	V AC 300
Permissible ambient temperature	
• During operation	°C -25 ... +55
• During storage	°C -40 ... +70
Operating range of excitation¹⁾	0.85 ... 1.1 x U_N at V AC/DC, 50/60 Hz 0.8 ... 1.25 x U_N at 24 V DC; 0.95 ... 1.05 times the rated frequency
Rated operational current I_e	
• AC-15 at 24 ... 240 V, 50 Hz	A 3
• DC-13 at	
- 24 V	A 1
- 125 V	A 0.2
Uninterrupted thermal current I_{th}	A 5
Mechanical endurance	Operating cycles 1 x 10 ⁷
Electrical endurance at I_e	Operating cycles 1 x 10 ⁵
Connection type	 Screw terminals
• Terminal screw	M3 (for standard screwdriver, size 2 and Pozidriv 2)
• Solid	1 x (0.2 ... 2.5)
• Finely stranded with end sleeve	1 x (0.25 ... 1.5)
• Finely stranded without end sleeve	1 x (0.2 ... 1.5)
• AWG cables, solid or stranded	1 x (24 ... 14)
• Tightening torque	Nm 0.4 ... 0.5

¹⁾ If nothing else is stated.

Relays

Timing Relays

7PV15 timing relays, 17.5 mm

7PV15 function diagrams

1 CO contact

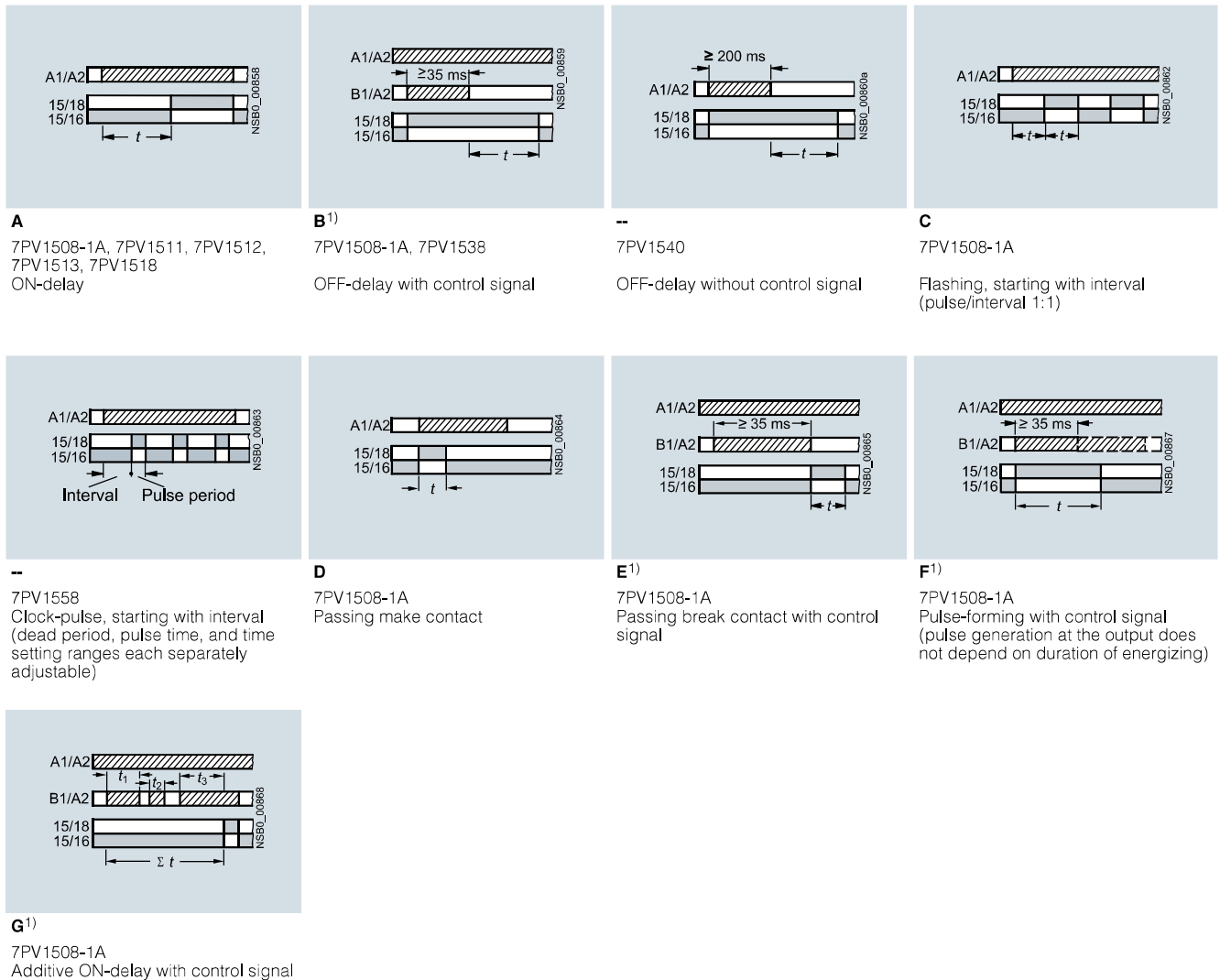

Legend

A ... G Identification letters for 7PV1508

- Timing relay energized
- Contact closed
- Contact open

¹⁾ Note on function with start contact: A new control signal at terminal B, after the operating time has started, resets the operating time to zero (retriggerable). This does not apply to E, F and G, which are not retriggerable.

Note:

With the 7PV1508-1A multifunctional timing relay the identification letters A to G are printed on the front alongside the rotary selector switch of the unit. The related function can be found in the form of a bar graph on the side of the device.

2 CO contacts

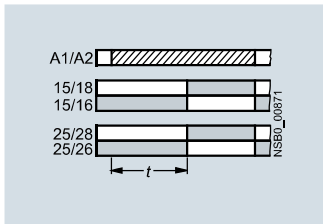

A
7PV1508-1B
ON-delay

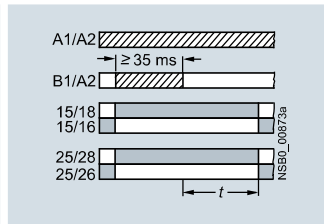

B1)
7PV1508-1B
OFF-delay with control signal

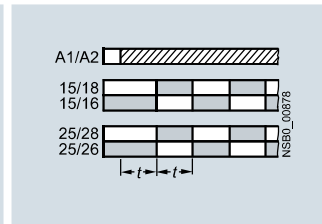

C
7PV1508-1B
Flashing, starting with interval
(pulse/interval 1:1)

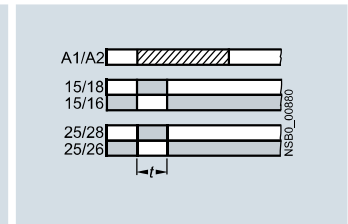

D
7PV1508-1B
Passing make contact

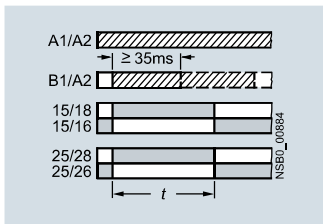

F1)
7PV1508-1B
Pulse-forming with control signal
(pulse generation at the output does not depend on duration of energizing)

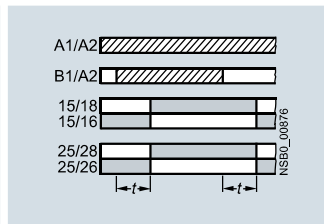

H1)
7PV1508-1B
ON-delay and OFF-delay with control signal

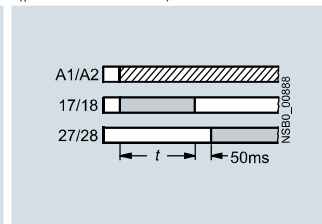

I
7PV1508-1B
Fixed pulse after ON-delay

2 NO contacts

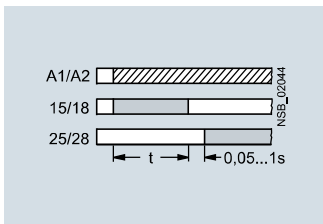

--
7PV1578
Wye-delta function²⁾

Legend

A ... D, F, H, I Identification letters for 7PV1508

- Timing relay energized
- Contact closed
- Contact open

¹⁾ Note on function with start contact: A new control signal at terminal B, after the operating time has started, resets the operating time to zero (retriggerable). This does not apply to E, F and G, which are not retriggerable.

²⁾ With 7PV1578 the contacts 16 and 26 are not needed for the wye-delta function.

Note:







With the 7PV1508-1B multifunctional timing relay the identification letters A to D, F, H, I are printed on the front alongside the rotary selector switch of the unit. The related function can be found in the form of a bar graph on the side of the device.

Relays

Timing Relays

7PV15 timing relays, 17.5 mm

Selection and ordering data

Version	Time setting range t adjustable by rotary switch to	Rated control supply voltage U_s	SD	⊕ Screw terminals	PU (UNIT, SET, M)	PS*	PG
		50/60 Hz AC V	DC V	d	Article No.	Price per PU	
							
7PV1508 timing relays, multifunction, 7 time setting ranges							
The functions can be adjusted by means of rotary switches. The same potential must be applied to terminals A. and B.							
With LED and 1 CO contact, 7 functions	0.05 ... 1 s 0.5 ... 10 s 5 ... 100 s	12 ... 240	12 ... 240	▶	7PV1508-1AW30	1	1 unit 41H
With LED and 2 CO contacts, 7 functions	30 s ... 10 min 3 min ... 1 h 30 min ... 10 h 5 ... 100 h	12 ... 240	12 ... 240	▶	7PV1508-1BW30	1	1 unit 41H
7PV1511 timing relays, ON-delay, 1 time setting range							
With LED and 1 CO contact	0.05 ... 1 s	24/200 ... 240	24	▶	7PV1511-1AP30	1	1 unit 41H
	0.5 ... 10 s	24/100 ... 127	24	▶	7PV1512-1AQ30	1	1 unit 41H
		24/200 ... 240	24	▶	7PV1512-1AP30	1	1 unit 41H
	5 ... 100 s	24/100 ... 127	24	▶	7PV1513-1AQ30	1	1 unit 41H
		24/200 ... 240	24	▶	7PV1513-1AP30	1	1 unit 41H
7PV1518 timing relays, ON-delay, 7 time setting ranges							
With LED and 1 CO contact	0.05 ... 1 s	12 ... 240	12 ... 240	▶	7PV1518-1AW30	1	1 unit 41H
	0.5 ... 10 s	90 ... 127	90 ... 127	▶	7PV1518-1AJ30	1	1 unit 41H
	5 ... 100 s	180 ... 240	180 ... 240	▶	7PV1518-1AN30	1	1 unit 41H
	30 s ... 10 min 3 min ... 1 h 30 min ... 10 h 5 ... 100 h						
7PV1538 timing relays, OFF-delay, with control signal, 7 time setting ranges							
With LED and 1 CO contact	0.05 ... 1 s 0.5 ... 10 s 5 ... 100 s 30 s ... 10 min 3 min ... 1 h 30 min ... 10 h 5 ... 100 h	12 ... 240	12 ... 240	▶	7PV1538-1AW30	1	1 unit 41H
7PV1540 timing relays, OFF-delay, without control signal, 7 time setting ranges							
With LED and 1 CO contact	0.05 ... 1 s 0.15 ... 3s 0.3 ... 6 s 0.5 ... 10 s 1.5 ... 30 s 3 ... 60 s 5 ... 100 s	12 ... 240	12 ... 240	▶	7PV1540-1AW30	1	1 unit 41H
7PV1558 timing relays, clock-pulse relay, 7 time setting ranges							
With LED and 1 CO contact	0.05 ... 1 s 0.5 ... 10 s 5 ... 100 s 30 s ... 10 min 3 min ... 1 h 30 min ... 10 h 5 ... 100 h	12 ... 240	12 ... 240	▶	7PV1558-1AW30	1	1 unit 41H
7PV1578 timing relays, wye-delta function, 7 time setting ranges							
With LED and 2 NO contacts, dead interval 0.05 ... 1 s adjustable	0.05 ... 1 s 0.5 ... 10 s 5 ... 100 s 30 s ... 10 min 3 min ... 1 h 30 min ... 10 h 5 ... 100 h	12 ... 240	12 ... 240	▶	7PV1578-1BW30	1	1 unit 41H

SIRIUS 3RT19 timing relays for mounting onto 3RT1 contactors

Overview



SIRIUS 3RT19 timing relay

SIRIUS 3RT19 electronic timing relays for mounting onto contactors with:

- 1 NO and 1 NC or 2 NO
- Monofunction
- Monovoltage
- Single or selectable time setting ranges

Article No. scheme

Product versions		Article number							
Time module and contactor control unit		3RT19	<input type="checkbox"/>	<input type="checkbox"/>	2	<input type="checkbox"/>	<input type="checkbox"/>	<input type="checkbox"/>	1
Size	e.g. 26 = S6 to S12		<input type="checkbox"/>	<input type="checkbox"/>					
Version	e.g. E = ON-delay					<input type="checkbox"/>			
Control supply voltage	e.g. J = 24 V AC/DC						<input type="checkbox"/>		
Time range	e.g. 1 = 0.05 ... 1 s							<input type="checkbox"/>	
Example		3RT19	2	6	-	2	E	J	1 1

Note:

The Article No. scheme shows an overview of product versions for better understanding of the logic behind the article numbers.

For your orders, please use the article numbers quoted in the selection and ordering data.

Relays

Timing Relays

SIRIUS 3RT19 timing relays for mounting onto 3RT1 contactors

Technical specifications

More information

Technical specifications, see <https://support.industry.siemens.com/cs/ww/en/ps/16361/td>
Manual and internal circuit diagrams, see <https://support.industry.siemens.com/cs/ww/en/ps/16361/man>

FAQs, see <https://support.industry.siemens.com/cs/ww/en/ps/16361/faq>

According to IEC 61812-1/DIN VDE 0435-2021

Type		Electronic timing relay blocks with semiconductor output 3RT19.6-2C, 3RT19.6-2D	Solid-state time-delay auxiliary switch blocks 3RT19.6-2E, 3RT19.6-2F, 3RT19.6-2G
Rated insulation voltage U_i Pollution degree 3 Overvoltage category III acc. to VDE 0110	V AC	300	
Permissible ambient temperature • During operation • During storage	°C °C	-25 ... +60 -40 ... +80	
Operating range of excitation		0.8 ... 1.1 $\times U_s$, 0.95 ... 1.05 times the rated frequency	0.85 ... 1.1 $\times U_s$, 0.95 ... 1.05 times the rated frequency
Rated operational currents I_e • Load current • AC-15, 24 ... 400 V, 50 Hz • DC-13, 24 V • DC-13, 125 V • DC-13, 250 V	A A A A A	0.3 for 3RT1916; 0.5 for 3RT1926 -- -- -- --	-- 3 1 0.2 0.1
Mechanical endurance	Operating cycles	100 $\times 10^6$	10 $\times 10^6$
Electrical endurance at I_e	Operating cycles	100 $\times 10^6$	1 $\times 10^5$
Connection type		 Screw terminals	
• Terminal screw • Solid • Finely stranded with end sleeve • AWG cables, solid or stranded • Tightening torque	mm ² mm ² AWG Nm	M3 (for standard screwdriver, size 2 and Pozidriv 2) 1 \times (0.5 ... 4)/2 \times (0.5 ... 2.5) 1 \times (0.5 ... 2.5)/2 \times (0.5 ... 1.5) 2 \times (20 ... 14) 0.8 ... 1.2	

3RT1926 function diagrams

1 NO contact + 1 NC contact

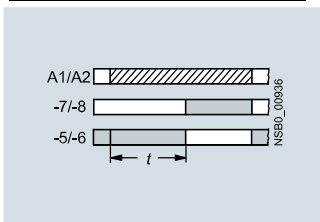

3RT1926-2E
ON-delay

1 NO contact (semiconductor)

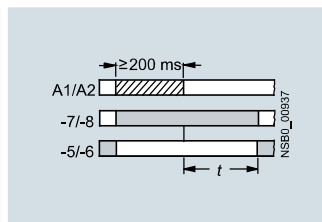

3RT1926-2F
OFF-delay without control signal

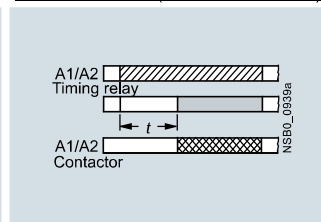

3RT1926-2C
ON-delay
two-wire design (varistor integrated)

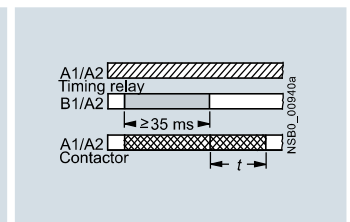



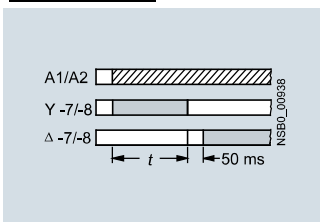

3RT1926-2D
OFF-delay
with control signal (varistor integrated)

2 NO contacts



3RT1926-2G
Wye-delta function
1 NO delayed, 1 NO instantaneous,
dead time 50 ms (varistor integrated)

Legend

-  Timing relay energized
-  Contact closed
-  Contact open
-  Contactor coil energized

SIRIUS 3RT19 timing relays for mounting onto 3RT1 contactors

Selection and ordering data

For contactors	Version	Time setting range t	Rated control supply voltage U_s	SD	Screw terminals	⊕	PU (UNIT, SET, M)	PS*	PG	
Type		s	V	d	Article No.	Price per PU				
For sizes S6 to S12¹⁾										
 3RT1926-2...	3RT10, 3RT14	Terminal designations acc. to EN 46199-5								
	• ON-delay									
	1 NO + 1 NC	0.05 ... 1	24 AC/DC	10	▶	3RT1926-2EJ11		1	1 unit	41H
		0.5 ... 10		▶	3RT1926-2EJ21		1	1 unit	41H	
		5 ... 100		▶	3RT1926-2EJ31		1	1 unit	41H	
		0.05 ... 1	100 ... 127 AC	15	▶	3RT1926-2EC11		1	1 unit	41H
		0.5 ... 10		▶	3RT1926-2EC21		1	1 unit	41H	
		5 ... 100		▶	3RT1926-2EC31		1	1 unit	41H	
		0.05 ... 1	200 ... 240 AC	5	▶	3RT1926-2ED11		1	1 unit	41H
		0.5 ... 10		▶	3RT1926-2ED21		1	1 unit	41H	
		5 ... 100		▶	3RT1926-2ED31		1	1 unit	41H	
	• OFF-delay without control signal ²⁾									
	1 NO + 1 NC	0.05 ... 1	24 AC/DC	▶	3RT1926-2FJ11		1	1 unit	41H	
		0.5 ... 10		▶	3RT1926-2FJ21		1	1 unit	41H	
		5 ... 100		▶	3RT1926-2FJ31		1	1 unit	41H	
	0.05 ... 1	100 ... 127 AC	5	▶	3RT1926-2FK11		1	1 unit	41H	
	0.5 ... 10		▶	3RT1926-2FK21		1	1 unit	41H		
	5 ... 100		▶	3RT1926-2FK31		1	1 unit	41H		
	0.05 ... 1	200 ... 240 AC	5	▶	3RT1926-2FL11		1	1 unit	41H	
	0.5 ... 10		▶	3RT1926-2FL21		1	1 unit	41H		
	5 ... 100		▶	3RT1926-2FL31		1	1 unit	41H		
• Wye-delta function (varistor integrated)										
1 NO delayed +	1.5 ... 30	24 AC/DC	▶	3RT1926-2GJ51		1	1 unit	41H		
1 NO instantaneous, dead time 50 ms		100 ... 127 AC	▶	3RT1926-2GC51		1	1 unit	41H		
		200 ... 240 AC	▶	3RT1926-2GD51		1	1 unit	41H		
For sizes S0 to S3, with semiconductor output										
3RT20 ²⁾	For mounting onto coil terminals on top of the contactors									
The electrical connection between the relay block and the corresponding contactor is established by screwing the two connecting pins of the timing relay block to coil terminals A1/A2 on top of the contactor.										
• ON-delay, two-wire design (varistor integrated)										
	0.05 ... 1	24 ... 66 AC/DC	5	▶	3RT1926-2CG11		1	1 unit	41H	
	0.5 ... 10		5	▶	3RT1926-2CG21		1	1 unit	41H	
	5 ... 100		5	▶	3RT1926-2CG31		1	1 unit	41H	
	0.05 ... 1	90 ... 240 AC/DC	▶	3RT1926-2CH11		1	1 unit	41H		
	0.5 ... 10		▶	3RT1926-2CH21		1	1 unit	41H		
	5 ... 100		▶	3RT1926-2CH31		1	1 unit	41H		
• OFF-delay with control signal (varistor integrated)										
	0.05 ... 1	24 ... 66 AC/DC	10	▶	3RT1926-2DG11		1	1 unit	41H	
	0.5 ... 10		5	▶	3RT1926-2DG21		1	1 unit	41H	
	5 ... 100		20	▶	3RT1926-2DG31		1	1 unit	41H	
	0.05 ... 1	90 ... 240 AC/DC	5	▶	3RT1926-2DH11		1	1 unit	41H	
	0.5 ... 10		5	▶	3RT1926-2DH21		1	1 unit	41H	
	5 ... 100		10	▶	3RT1926-2DH31		1	1 unit	41H	

¹⁾ The terminals A1 and A2 for the rated control supply voltage of the solid-state time-delay auxiliary switch block must be connected to the corresponding contactor by connecting cables.

²⁾ Not for 3RT104 contactor with 24 to 42 V rated control supply voltage.