

KEMET Part Number: SC-15-02J
(UALSC1502J0000)

KEMET, SC-J, AC Line Filters, Common Mode, 200 uH

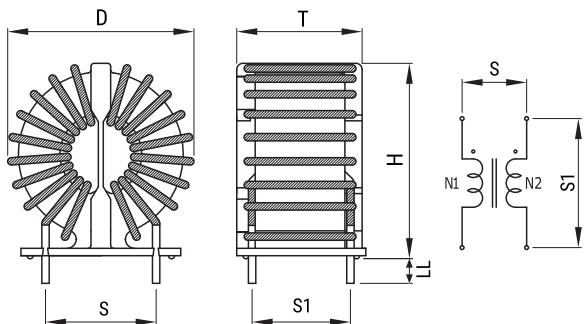

Dimensions

D	34mm MAX
T	23mm MAX
H	33mm MAX
LL	5mm +/-2mm
S	18mm NOM

Packaging Specifications

Packaging:	Tray
Packaging Quantity:	200
Weight:	43 g

General Information

Series:	SC-J
Style:	Through-Hole
RoHS:	Yes
Notes:	Lead Spacing (S/S1) Are For Reference Only.
Miscellaneous:	Temperature Rise Maximum: 45 K

Specifications

Voltage AC:	250 VAC
Inductance:	0.2 mH (100 kHz)
Current:	15 A
Temperature Range:	-25/+120°C
DC Resistance:	6 mOhms

Statements of suitability for certain applications are based on our knowledge of typical operating conditions for such applications, but are not intended to constitute - and we specifically disclaim - any warranty concerning suitability for a specific customer application or use. This Information is intended for use only by customers who have the requisite experience and capability to determine the correct products for their application. Any technical advice inferred from this Information or otherwise provided by us with reference to the use of our products is given gratis, and we assume no obligation or liability for the advice given or results obtained.