

KEMET Part Number: SC-10-18J
(UALSC1018J0000)

KEMET, SC-J, AC Line Filters, Common Mode, 1600 μ H

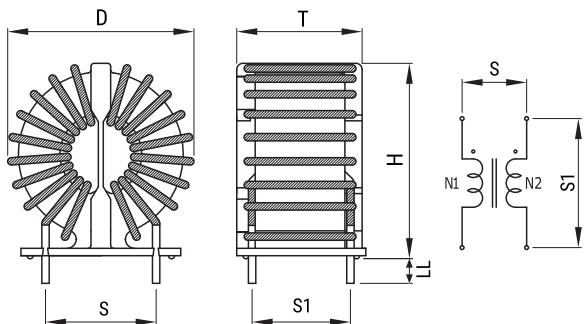

Dimensions

D	34mm MAX
T	24mm MAX
H	33mm MAX
LL	7mm +/-2mm
S	18mm NOM

Packaging Specifications

Packaging:	Tray
Packaging Quantity:	200
Weight:	45.2 g

General Information

Series:	SC-J
Style:	Through-Hole
RoHS:	Yes
Notes:	Lead Spacing (S/S1) Are For Reference Only.
Miscellaneous:	Temperature Rise Maximum: 55 K

Specifications

Voltage AC:	250 VAC
Inductance:	1.6 mH (1 kHz)
Current:	10 A
Temperature Range:	-25/+120°C
DC Resistance:	20 mOhms