

KEMET Part Number: SC-08-700
(UALSC087000000)

KEMET, SC, AC Line Filters, Common Mode, 7000 uH

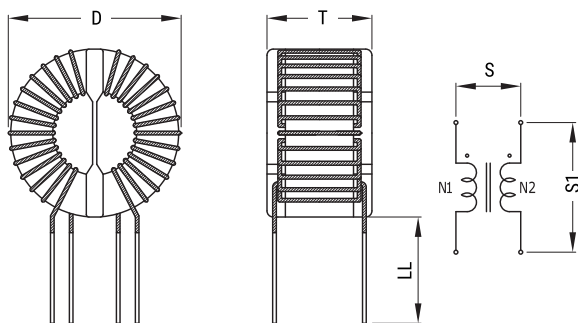

Dimensions

D	50mm MAX
T	30mm MAX
LL	15mm +/-2mm
S	10mm NOM

Packaging Specifications

Packaging:	Tray
Packaging Quantity:	60
Weight:	103.6 g

General Information

Series:	SC
Style:	Through-Hole
RoHS:	Yes
Notes:	Lead Spacing (S/S1) Are For Reference Only.
Miscellaneous:	Temperature Rise Maximum: 55 K

Specifications

Voltage AC:	250 VAC
Inductance:	7 mH (1 kHz)
Current:	8 A
Temperature Range:	-25/+105°C
DC Resistance:	40 mOhms