

KEMET Part Number: SC-07-90J
(UALSC0790J0000)

KEMET, SC-J, AC Line Filters, Common Mode, 9000 μ H

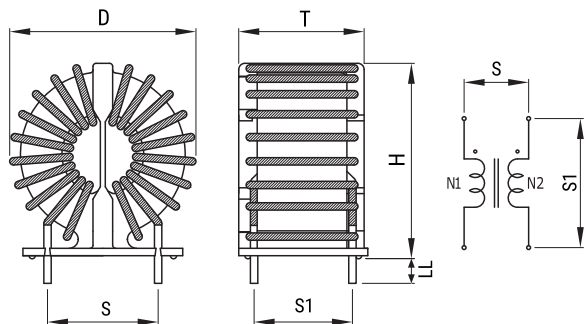

Dimensions

D	34mm MAX
T	23mm MAX
H	33mm MAX
LL	5mm +/-2mm
S	18mm NOM

Packaging Specifications

Packaging:	Tray
Packaging Quantity:	200
Weight:	45.8 g

General Information

Series:	SC-J
Style:	Through-Hole
RoHS:	Yes
Notes:	Lead Spacing (S/S1) Are For Reference Only.
Miscellaneous:	Temperature Rise Maximum: 85 K

Specifications

Voltage AC:	250 VAC
Inductance:	9 mH (10 kHz)
Current:	7 A
Temperature Range:	-25/+120°C
DC Resistance:	50 mOhms