

KEMET Part Number: SC-07-70J
(UALSC0770J0000)

KEMET, SC-J, AC Line Filters, Common Mode, 7000 μ H

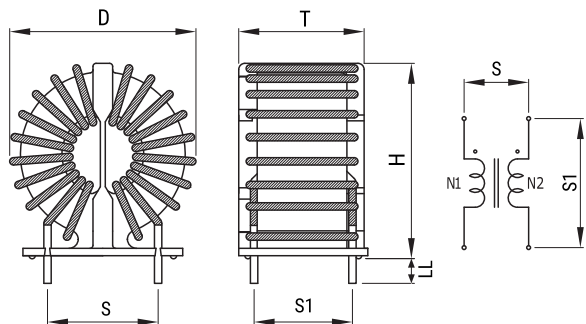

Dimensions	
D	35mm MAX
T	25mm MAX
H	35mm MAX
LL	5mm +/-2mm
S	18mm NOM

Packaging Specifications	
Packaging:	Tray
Packaging Quantity:	200
Weight:	45 g

General Information	
Series:	SC-J
Style:	Through-Hole
RoHS:	Yes
Notes:	Lead Spacing (S/S1) Are For Reference Only.
Miscellaneous:	Temperature Rise Maximum: 65 K

Specifications	
Voltage AC:	250 VAC
Inductance:	7 mH (1 kHz)
Current:	7 A
Temperature Range:	-25/+120°C
DC Resistance:	40 mOhms