

KEMET Part Number: SC-05-27J
(UALSC0527J0000)

KEMET, SC-J, AC Line Filters, Common Mode, 2700 μ H

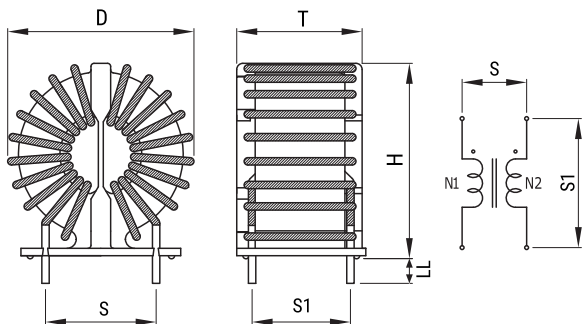

Dimensions

D	25mm MAX
T	20mm MAX
H	27mm MAX
LL	5mm +/-2mm
S	10mm NOM

Packaging Specifications

Packaging:	Tray
Packaging Quantity:	400
Weight:	19.4 g

General Information

Series:	SC-J
Style:	Through-Hole
RoHS:	Yes
Notes:	Lead Spacing (S/S1) Are For Reference Only.
Miscellaneous:	Temperature Rise Maximum: 57 K

Specifications

Voltage AC:	250 VAC
Inductance:	2.7 mH (1 kHz)
Current:	5 A
Temperature Range:	-25/+120°C
DC Resistance:	40 mOhms