

KEMET Part Number: SC-03-85J
(UALSC0385J0000)

KEMET, SC-J, AC Line Filters, Common Mode, 8500 μ H

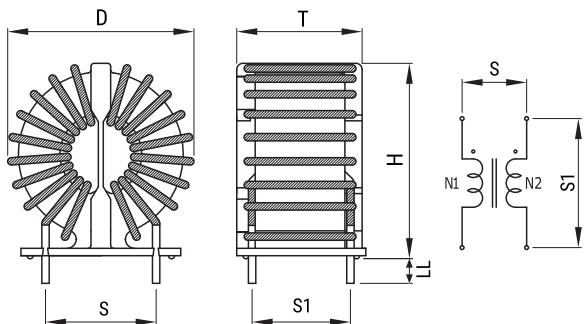

Dimensions

D	25mm MAX
T	20mm MAX
H	27mm MAX
LL	5mm +/-2mm
S	10mm NOM

Packaging Specifications

Packaging:	Tray
Packaging Quantity:	400
Weight:	22 g

General Information

Series:	SC-J
Style:	Through-Hole
RoHS:	Yes
Notes:	Lead Spacing (S/S1) Are For Reference Only.
Miscellaneous:	Temperature Rise Maximum: 60 K

Specifications

Voltage AC:	250 VAC
Inductance:	8.5 mH (10 kHz)
Current:	3 A
Temperature Range:	-25/+120°C
DC Resistance:	110 mOhms