

KEMET Part Number: SC-02-10JS
(UALSC0210JS000)

KEMET, SC-JS, AC Line Filters, Common Mode, 1000 uH

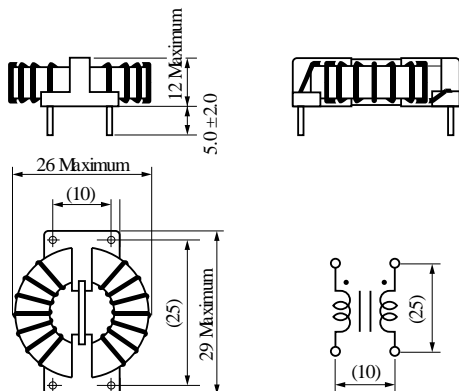

Dimensions

L	26mm MAX
T	29mm MAX
H	12mm MAX
LL	5mm +/-2mm
S	10mm NOM

Packaging Specifications

Packaging:	Tray
Packaging Quantity:	400
Weight:	8 g

General Information

Series:	SC-JS
Style:	Through-Hole
RoHS:	Yes
Notes:	Lead Spacing (S/S1) Are For Reference Only.
Miscellaneous:	Temperature Rise Maximum: 40 K

Specifications

Voltage AC:	250 VAC
Inductance:	1 mH
Current:	2 A
Temperature Range:	-25/+105°C
DC Resistance:	100 mOhms