

RTS-01 Series

Characteristic

RTS-01 high power resistors are made in a thick film technology, on a 2mm stainless steel substrate. Resistors are characterized by a high power at small size, and high resistance to a temporary overloads. RTS-01 resistors have very low inductance, what makes them useful at high frequency circuits. Construction of element allows for a quick installation on heatsink (SOT-227 housing compatibility). RTS-01 series elements have outputs in the form of contact/solder fields, soldered wires, connectors, or screw terminals.

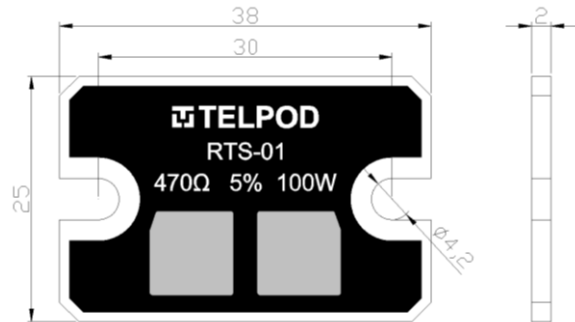
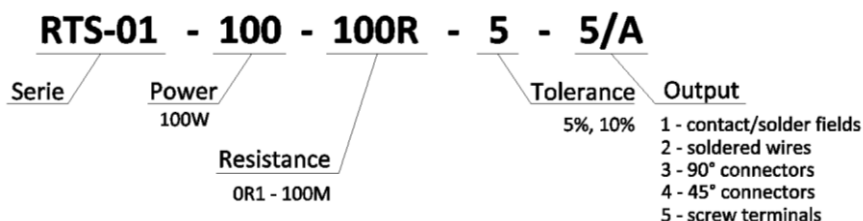

Fig. 1. Preview with dimensions [mm]

Parameter	Value
Nominal resistance	E24 series
Range of available resistances	0,1 Ω ... 1 MΩ
Resistance tolerance	±5%, ±10 %
Rated power (on heatsink)	100W
Dielectric layer breakdown voltage	> 2,5 kV
Temperature coefficient of resistance (TCR)	±100 ppm/°C
Max. element temperature (on surface)	400 °C
Max. element temperature (with soldered connectors or wires)	170 °C

Product marking



RTS-01 Series

Terminal types

RTS-01- ... -1

Contact / solder fields

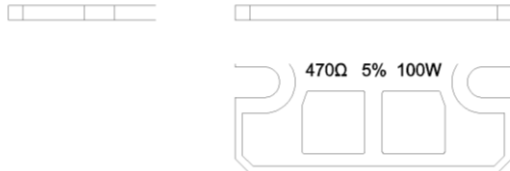

RTS-01- ... -2

Soldered wires

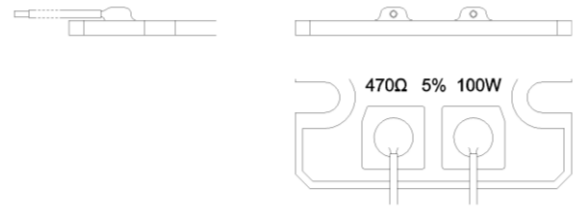

RTS-01- ... -3/4.8

4.8 connectors at 90°

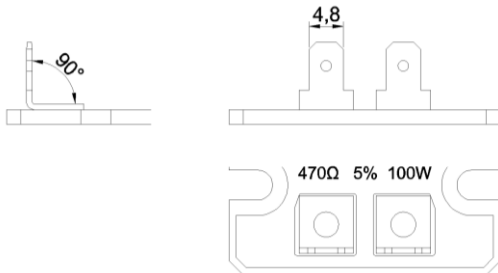

RTS-01- ... -3/6.3

6.3 connectors at 90°

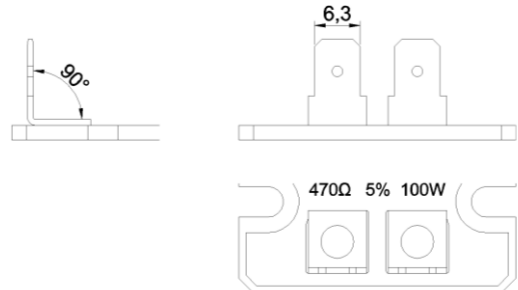

RTS-01- ... -4/4.8

4.8 connectors at 45°

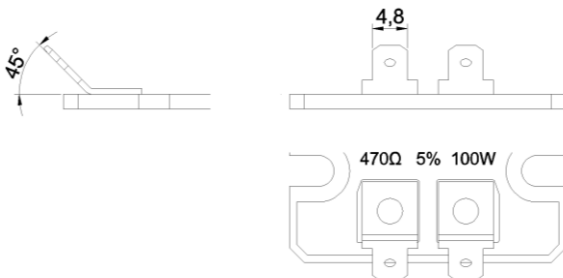

RTS-01- ... -4/6.3

6.3 connectors at 45°

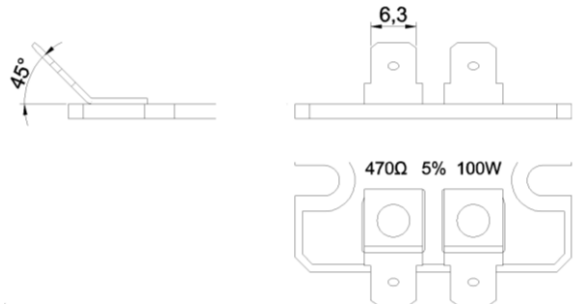

RTS-01- ... -5/A

Screw connectors with the nuts

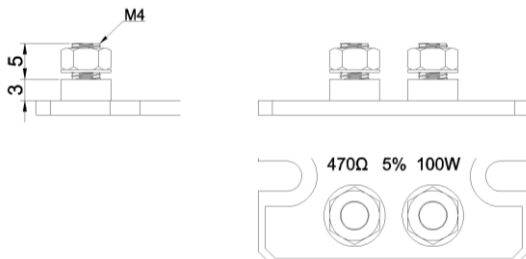

RTS-01- ... -5/B

Screw connectors with the screws

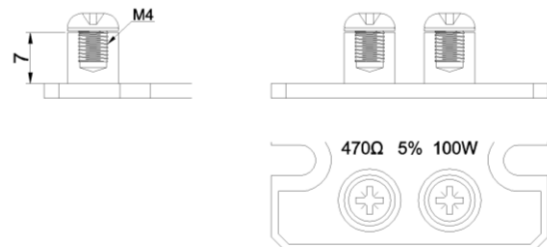

TELPOD S.A.

str. Pilsudskiego 63A
32-050 Skawina
www.telpod.pl

Technical division: +48 (0)12 257 10 12
Sales division: +48 (0)12 257 10 35
fax: +48 (0)12 257 10 13
e-mail: thickfilm@telpod.pl

date: 05 / 2015
Copyright 2015 by Telpod