

Three Phase Rectifier Bridge

PSD 36T PSD 36TN

$I_{dAVM} = 35 \text{ A}$
 $V_{RRM} = 1200 \text{ V to } 2200 \text{ V}$

Preliminary Data Sheet

V_{RSM} V	V_{RRM} V	Type Number	
		Gold-plated terminals	Nickel-plated terminals
1200	1200	PSD 36T/12	PSD 36TN/12
1400	1400	PSD 36T/14	PSD 36TN/14
1600	1600	PSD 36T/16	PSD 36TN/16
1800	1800	PSD 36T/18	PSD 36TN/18
2000	2000	PSD 36T/20	PSD 36TN/20
2200	2200	PSD 36T/22	PSD 36TN/22

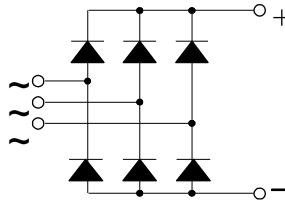

Symbol	Test Conditions	Maximum Ratings	
I_{dAVM}	$T_c = 62^\circ\text{C}$ per module	35 A	
I_{FSM}	$T_{vj} = 45^\circ\text{C}$, $V_R = 0 \text{ V}$, $t = 10 \text{ ms}$	550 A	
	$T_{vj} = T_{vjM}$, $V_R = 0 \text{ V}$, $t = 10 \text{ ms}$	500 A	
$\int i^2 dt$	$T_{vj} = 45^\circ\text{C}$, $V_R = 0 \text{ V}$, $t = 10 \text{ ms}$	1520 A ² s	
T_{vj}		-40 ... +150 °C	
T_{vjM}		150 °C	
T_{stg}		-40 ... +150 °C	
	V_{isol} 50/60 Hz, RMS	$t = 1 \text{ min}$	2500 V~
	$I_{isol} \leq 1 \text{ mA}$	$t = 1 \text{ s}$	3000 V~
M_d	Mounting torque (M5)		2±10% Nm
		(10-32 UNF)	18±10% lb in
Weight	typ.		22 g

Features

- ¼" gold- or nickel-plated FASTON terminals
- Isolation voltage 3000 V~
- Mesa glass-passivated chips
- Blocking voltage up to 2200 V
- Low forward voltage drop
- UL registered E 148688

Applications

- Supplies for DC power equipment
- Input rectifiers for PWM inverters
- Battery DC power supplies
- Field supply of DC motors

Advantages

- Easy to mount with one screw
- Space and weight savings
- Improved temperature and power cycling capability

Package style and outline

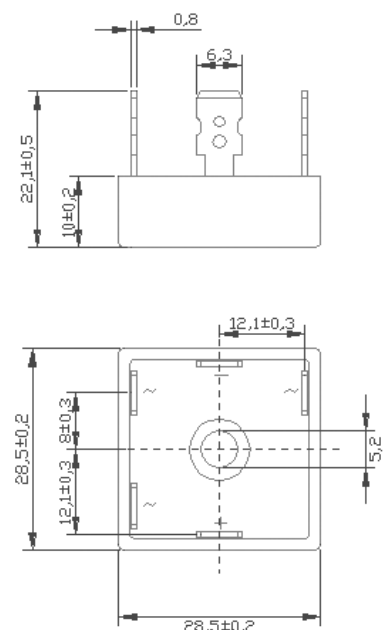

Dimensions in mm (1mm = 0.0394")

Symbol	Test Conditions	Characteristic Value
I_R	$V_R = V_{RRM}$, $T_{vj} = 25^\circ\text{C}$	≤ 0.3 mA
	$V_R = V_{RRM}$, $T_{vj} = T_{vjM}$	≤ 2.0 mA
V_F	$I_F = 150 \text{ A}$, $T_{vj} = 25^\circ\text{C}$	≤ 1.7 V
V_{TO}	For power-loss calculations only	0.8 V
r_T	$T_{vj} = T_{vjM}$	7.4 mΩ
$R_{th(j-c)}$	per diode; DC current	7.5 K/W
	per module	1.25 K/W
$R_{th(j-s)}$	per diode; DC current	8.4 K/W
	per module	1.4 K/W
d_s	Creeping distance on surface	12.7 mm
d_A	Creeping distance on air	9.4 mm
a	Maximum allowable acceleration	50 m/s ²

Data according to IEC 60747 refers to a single diode unless otherwise stated

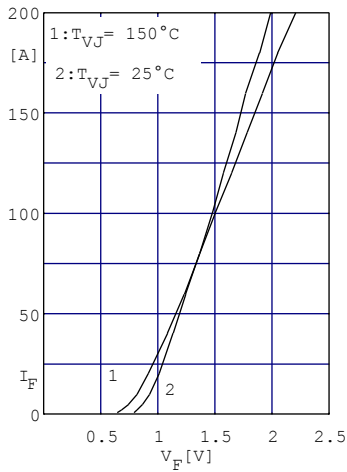

Fig. 1 Forward current versus voltage drop per diode

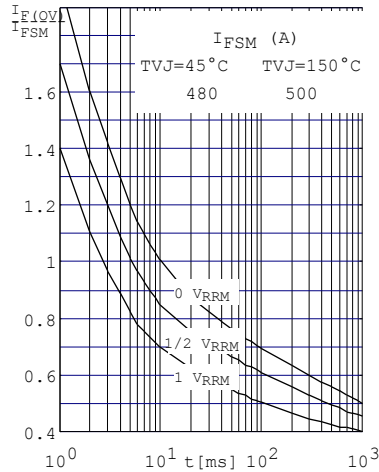

Fig. 2 Surge overload current per diode I_{FSM} : Crest value. t :duration

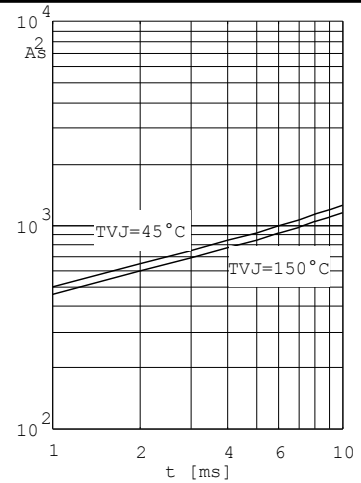

Fig. 3 $\int I^2 dt$ versus time (1-10ms) per diode (or thyristor)

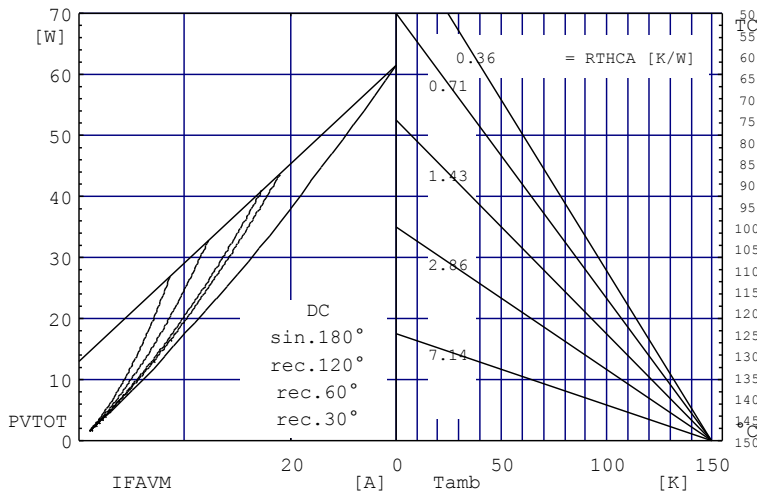

Fig. 4 Power dissipation versus direct output current and ambient temperature

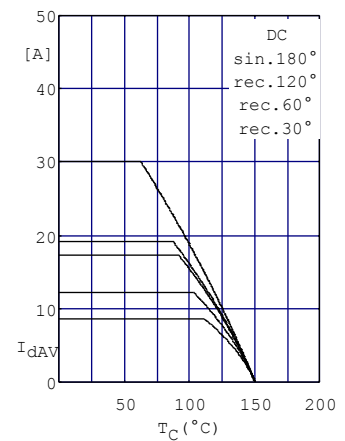

Fig. 5 Maximum forward current at case temperature

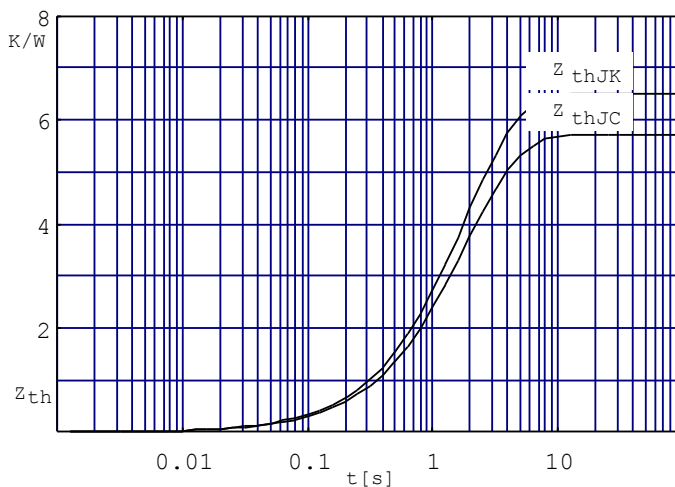

Fig. 6 Transient thermal impedance per diode (or thyristor), calculated