

CATALOGUE

# PROFIX®



2019



It is with great satisfaction that we provide you with the next edition of our product catalogue. We have expanded our offer with new product ranges of hand tools, power tools, as well as personal protective equipment. Our offer currently includes over 20,000 top quality products. This wealth of options and their diversity guarantee that every user will find products that meet their individual expectations. With them work is easy and safe, and professional duties become more pleasant and more efficient. The huge expansion of our range is not the only change we have made in our company. In July 2018, we completed the first stage of the our Logistics Centre expansion. We now have nearly 20,000 m<sup>2</sup> of warehouse and office space at our disposal. During the investment, we have significantly expanded and supplemented the service facilities, the R&D department and the quality control department. Over the coming years this will allow us to dynamically expand our product range and the offered services, with such options as post-warranty repairs or comprehensive brand labeling for clothing using a wide range of techniques. By providing you with our new catalog, we hope that it will help you in your everyday work and contribute to further development of cooperation with Profix.

### Profix management



С большим удовлетворением мы передаем Вам очередное издание нашего каталога изделий. Предлагаемый нами ассортимент мы разнообразили новыми линиями ручных инструментов, электроинструментов, а также средств индивидуальной защиты. В настоящее время наше торговое предложение включает в себя уже свыше 20 000 продуктов наивысшего качества.

Его богатство и вместе с тем разнообразие гарантирует то, что каждый пользователь найдет в нем продукты, которые удовлетворяют его индивидуальные ожидания. Позволят удобно и безопасно работать, а выполнение профессиональных обязанностей сделают более приятным и эффективным.

Интенсивное расширение ассортимента - не единственное изменение, которое мы провели в нашей компании. В июле 2018 года мы завершили первый этап расширения Центра Логистики. В настоящее время общая площадь складских и офисных помещений, которой мы располагаем, составляет около 20 000 м<sup>2</sup>. В ходе инвестиции мы значительно расширили и дооснастили сервисную базу, отдел испытаний и развития, а также отдел контроля качества. Это позволит нам в перспективе последующих лет динамично расширять спектр предлагаемых изделий и услуг, в частности, послегарантийного ремонта, комплексной рекламной маркировки одежды, выполняемой в широком спектре техник.

Передавая Вам наш каталог, мы надеемся, что он поможет Вам в Вашей ежедневной работе и станет импульсом к дальнейшему развитию сотрудничества с компанией Profix.

### Правление Profix

Mit echter Zufriedenheit übergeben wir Ihnen die nächste Ausgabe unseres Produktkatalogs. Wir haben unser Angebot um neue Produktlinien für Handwerkzeuge, Elektrowerkzeuge und persönliche Schutzausrüstung erweitert. Derzeit umfasst unser Angebot über 20.000 Produkte von höchster Qualität. Sein Reichtum und seine Vielfalt garantieren gleichzeitig, dass jeder Benutzer Produkte findet, die seinen individuellen Erwartungen entsprechen. Sie ermöglichen Ihnen ein bequemes und sicheres Arbeiten und machen die Ausübung professioneller Aufgaben angenehmer und effizienter.

Die enorme Entwicklung des Sortiments ist nicht die einzige Änderung, die wir in unserem Unternehmen vorgenommen haben. Im Juli 2018 haben wir die erste Ausbaustufe des Logistikzentrums abgeschlossen. Derzeit stehen uns insgesamt 20.000 m<sup>2</sup> Lager- und Bürofläche zur Verfügung. Während der Investition haben wir die Serviceeinrichtungen, die Forschungs- und Entwicklungsabteilung und die Qualitätskontrollabteilung erheblich erweitert und ergänzt. Dies ermöglicht es uns, das Spektrum der angebotenen Produkte im Hinblick auf die folgenden Jahre sowie die angebotenen Dienstleistungen wie Reparaturen nach der Garantiezeit oder umfassende Werbekennzeichnung von Bekleidung für eine Vielzahl von Techniken dynamisch zu erweitern.

Wir hoffen, dass wir Ihnen mit unserem neuen Katalog hilfreiche Arbeit leisten und zur Weiterentwicklung der Zusammenarbeit mit Profix beitragen werden.

### Geschäftsführung von Profix

**PROLINE**

MECHANICAL TOOLS AND WORKSHOP ACCESSORIES ... 24-119  
 PNEUMATIC TOOLS AND ASSECCORIES ..... 120-131  
 CONSTRUCTION, DECORATING AND LOCKSMITH TOOLS..... 132-178  
 TOOLS FOR JOINING ..... 179-193  
 TOOL STORAGE PRODUCTS ..... 194-199  
 GARDENING HAND TOOLS ..... 200-217  
 POWER TOOL ACCESSORIES ..... 218-268

**LAHTI PRO**

BODY PROTECTION..... 271-330  
 HEAD AND HEARING PROTECTION..... 331-338  
 EYE AND FACE PROTECTION ..... 339-348  
 RESPIRATORY PROTECTION..... 349-352  
 WORK AT HEIGHTS ..... 353-355  
 HAND PROTECTION..... 356-377  
 LEG PROTECTION..... 378-401  
 TECHNICAL INFORMATION..... 414-430

**MEGA**

GENERAL PURPOSE TOOLS ..... 467-491  
 POWER TOOL ACCESSORIES ..... 492-503

**JUCO**

HAND TOOLS..... 504-512

**OTHER BRANDS**

HAND TOOLS..... 513-554

**ERDI**

SNIPS..... 555-557

**KLINGSPOR**

GRINDING AND CUTTING DISCS, ABRASSIVE  
 ACCESSORIES ..... 558-566

**EXPRESS**

GAS POWERED PRODUCTS ..... 567-571

**ACTION CAN**

CLEANING MEASURES, GREASES, OILS, REMOVERS,  
 CHEMICALS ..... 572-576

**TRYTON**

POWER TOOLS AND ACCESSORIES ..... 582-610  
 GARDENING MACHINERY ..... 611-626

**VULCAN CONCEPT**

POWER TOOLS AND ACCESSORIES ..... 629-634  
 GARDENING MACHINERY ..... 635

**PRODUCT CODE INDEX**

PRODUCT CODE INDEX ..... 636-646

**PROLINE**

МЕХАНИЧЕСКИЙ ИНСТРУМЕНТ И ПРИНАДЛЕЖНОСТИ ДЛЯ АВТОМАСТЕРСКОЙ .....	24-119
ПНЕВМАТИЧЕСКИЙ ИНСТРУМЕНТ И ПРИНАДЛЕЖНОСТИ ..	120-131
СТРОИТЕЛЬНЫЙ, ДЕКОРАТОРСКИЙ, СЛЕСАРНЫЙ ИНСТРУМЕНТ .....	132-178
РУЧНОЙ ИНСТРУМЕНТ ДЛЯ СОЕДИНЕНИЙ .....	179-193
СКЛАДИРОВАНИЕ ИНСТРУМЕНТА .....	194-199
САДОВЫЙ ИНСТРУМЕНТ .....	200-217
ПРИНАДЛЕЖНОСТИ ДЛЯ ЭЛЕКТРОИНСТРУМЕНТА .....	218-268

**LANTI PRO**

ЗАЩИТА ТЕЛА .....	271-330
ЗАЩИТА ГОЛОВЫ И ОРГАНОВ СЛУХА .....	331-338
ЗАЩИТА ГЛАЗ И ЛИЦА .....	339-348
ЗАЩИТА ОРГАНОВ ДЫХАНИЯ .....	349-352
РАБОТА НА ВЫСОТЕ .....	353-355
ЗАЩИТА РУК .....	356-377
ЗАЩИТА НОГ .....	378-401
ТЕХНИЧЕСКИЕ ХАРАКТЕРИСТИКИ .....	431-447

**MEGA**

ИНСТРУМЕНТЫ ОБЩЕГО ИСПОЛЬЗОВАНИЯ .....	467-491
ПРИНАДЛЕЖНОСТИ ДЛЯ ЭЛЕКТРОИНСТРУМЕНТА .....	492-503

**JUCO**

РУЧНОЙ ИНСТРУМЕНТ .....	504-512
-------------------------	---------

**ДРУГИЕ БРЕНДЫ**

РУЧНОЙ ИНСТРУМЕНТ .....	513-554
-------------------------	---------

**ERDI**

НОЖНИЦЫ .....	555-557
---------------	---------

**KLINGSPOR**

ДИСКИ ДЛЯ РЕЗКИ И ШЛИФОВКИ, АБРАЗИВНЫЕ МАТЕРИАЛЫ .....	558-566
--	---------

**EXPRESS**

ПАЯЛЬНЫЕ ЛАМПЫ, ГАЗОВЫЕ КАРТРИДЖИ .....	567-571
---	---------

**ACTION CAN**

ЧИСТЯЩИЕ СРЕДСТВА, СМАЗКИ, МАСЛА, РАСТВОРИТЕЛИ, ХИМИЧЕСКИЕ ПРЕПАРАТЫ .....	572-576
--	---------

**TRYTON**

ЭЛЕКТРОИНСТРУМЕНТ И ПРИНАДЛЕЖНОСТИ .....	582-610
САДОВЫЕ МАШИНЫ .....	611-626

**VULCAN CONCEPT**

ЭЛЕКТРОИНСТРУМЕНТ .....	629-634
САДОВЫЕ МАШИНЫ .....	635

**АРТИКУЛЬНЫЙ УКАЗАТЕЛЬ**

АРТИКУЛЬНЫЙ УКАЗАТЕЛЬ .....	636-646
-----------------------------	---------

**PROLINE**

MECHANISCHE WERKZEUGE UND WERKSTATTZUBEHÖR .....	24-119
PNEUMATISCHE WERKZEUGE UND ZUBEHÖR .....	120-131
BAU-, DEKORATIONS- UND SCHLOSSER-WERKZEUGE ....	132-178
WERKZEUGE ZUR VERBINDUNG .....	179-193
PRODUKTE FÜR DIE LAGERUNG VON WERKZEUG .....	194-199
GARTENHANDWERKZEUGE .....	200-217
ELEKTROWERKZEUG-ZUBEHÖR .....	218-268

**LAHTI PRO**

KÖRPERSCHUTZ .....	271-330
KOPF- UND GEHÖRSCHUTZ .....	331-338
AUGEN- UND GESICHTSSCHUTZ .....	339-348
ATEMSCHUTZ .....	349-352
HÖHENARBEITEN .....	353-355
HANDSCHUTZ .....	356-377
BEINSCHUTZ .....	378-401
TECHNISCHE INFORMATIONEN .....	448-464

**MEGA**

ALLZWECK-WERKZEUGE .....	467-491
ELEKTROWERKZEUG-ZUBEHÖR .....	492-503

**JUCO**

HANDWERKZEUGE .....	504-512
---------------------	---------

**ANDERE MARKEN**

HANDWERKZEUGE .....	513-554
---------------------	---------

**ERDI**

BLECHSCHEREN.....	555-557
-------------------	---------

**KLINGSPOR**

SCHLEIF- UND TRENNSCHEIBEN, SCHLEIFZUBEHÖR .....	558-566
---	---------

**EXPRESS**

GASBETRIEBENE PRODUKTE .....	567-571
------------------------------	---------

**ACTION CAN**

REINIGUNGSMITTEL, FETTE, ÖLE, ENTFERNER, CHEMIKALIEN .....	572-576
---	---------

**TRYTON**

ELEKTROWERKZEUGE UND ZUBEHÖR .....	582-610
GARTENMASCHINEN .....	611-626







**VULCAN CONCEPT**

ELEKTROWERKZEUGE UND ZUBEHÖR .....	629-634
GARTENMASCHINEN .....	635





**PRODUKTCODE INDEX**

PRODUKTCODE INDEX .....	636-646
-------------------------	---------

Standards, certificates | Аттесты, сертификаты | Bescheinigungen, Zertifikate

	According to DIN standards with a given number	Соответствует норме DIN с номером нормы	Entspricht der DIN-Norm mit der angegebenen Nummer
	According to norm with a given number	Соответствует норме под указанным номером	Entspricht der Norm mit der angegebenen Nummer
	Accuracy class (I, II, III)	Класс точности, может быть I, II, III	Genauigkeitsklasse, kann "I", "II", "III" sein
	CE certified	Имеет обозначение CE	CE-Kennzeichnung
	Volatile organic compound [VOC] emission class (very low emission)	Класс эмиссии летучих органических соединений [ЛОС] (очень низкая эмиссия)	Emissionsklasse flüchtiger organischer Verbindungen (VOC) (sehr geringe Emission)
	Protection level	Уровень защиты	Schutzart / Dichtheitsklasse

Packing | Упаковка | Verpackungen

	Card or wallet	Карта или блистер	Karte oder Etui
	Individual box	Индивидуальная упаковка	Einzelbox
	Plastic box with hanger	Пластиковая коробка с петлей	Plastikbox mit Anhänger
	Box with hanger	Коробка с петлей	Box mit Anhänger
	Box quantity	Общая упаковка	Sammelverpackung

Measurements | Размеры | Messung

	Blade length	Длина лезвия	Klingenlänge
	Blade width	Высота лезвия	Klingenstärke
	Product size	Размеры товара	Produktabmessungen
	Product length	Длина товара	Länge des Produkts
	Tape width	Ширина ленты	Breite des Bands
	Tool width	Ширина инструмента	Werkzeugbreite









Max. range	Максимальный зев	Maximaler Abstand
Max. bar diameter	Максимальный диаметр	Maximaler Stangendurchmesser
Accuracy	Точность	Genauigkeit
Scale cm/inches	Шкала см/дюймы	Skala cm/Zoll
Measurement range of DC voltage	Диапазон измерения напряжения постоянного тока	Gleichspannungsmessbereich
Measurement range of AC voltage	Диапазон измерения напряжения переменного тока	Wechselspannungsmessbereich
Measurement range of current	Диапазон измерения напряжения тока	Stromstärkenmessbereich
Measurement range of resistance	Диапазон измерения сопротивления	Widerstandsmessbereich
Acoustic signal	Звуковой сигнал	Tonsignal
Disc size	Размер диска	Scheibengröße
Capacity	Объем	Kapazität
Frame length	Размер тубы	Abmessungen der Kartusche
Working temperature	Рабочая амплитуда температуры	Arbeitstemperaturbereich
Size in inches	Дюймовый размер	Abmessung in Zoll
Max. diameter	Максимальный диаметр	Maximaler Durchmesser
Diameter	Диаметр	Durchmesser
Diameter range	Диапазон диаметров	Durchmesserbereich
Bolt diameter	Диаметр стержня	Durchmesser der Spindel
Bore diameter	Посадочное отверстие	Durchmesser der Zentrier- / Befestigungsöffnung

	Bore diameter	Посадочное отверстие	Durchmesser der Zentrier- / Befestigungsöffnung		Adjustment range	Диапазон регулировки	Einstellbereich
	Hose diameter	Диаметр шланга	Schlauchdurchmesser		Cable size	Размер шнура	Kabelgröße
	Tap diameter	Диаметр присоединения воды	Wasseranschlussdurchmesser		Quantity and power of the lamp	Количество и мощность освещения	Menge und Leistung der Beleuchtung
	Cable diameter ranges	Диапазон диаметров кабеля	Kabeldurchmesserbereich		Rivet size	Размеры заклёпок	Größen der Nieten
	Quantity and thickness of cable	Количество и толщина кабелей	Anzahl und Dicke der Drähte		Number of nozzles	Количество сопел	Düsenanzahl
	Weight	Собственный вес	Eigengewicht		Number of sockets	Количество розеток	Anzahl Steckdosen
	Capacity	Объем	Kapazität		Number of LED	Количество диод LED	Anzahl LEDs
	Capacity	Объем	Kapazität		Chuck diameter	Диаметр зажима	Griffdurchmesser
	Length	Длина	Länge		Number of teeth	Количество зубцов на дюйм	Anzahl der Zähne
	Area range	Диапазон поля	Feldbereich		Number of feeler gauge leaves	Количество листов шупа	Anzahl der Fühlerlehrenstreifen
	Max. thickness	Максимальная толщина	Maximale Dicke		Type of feeler gauge end	Тип насадки шупа	Art der Fühlerlehrenspitze
	Max. thickness	Макс. толщина	Maximale Dicke	<b>Materials   Материал   Material</b>			
	Temperature	Температура	Temperatur		Steel hardness	Твердость стали с представленной характеристикой	Härte von Stahl mit gegebenem Wert
	Flame temperature	Температура пламени	Flammentemperatur		Sk5 Japanese steel	Углеродистая сталь	Kohlenstoffreicher Stahl
	Power	Мощность	Leistung		3Cr13 chrome steel	Хромированная сталь	Chromstahl 3Cr13
	Gas usage	Потребление газа	Gasverbrauch		High speed steel	Быстрорежущая сталь	Schnellarbeitsstahl
	Lifting capacity in tons or kilograms	Потребление газа	Zulässige Tragfähigkeit in (t) oder (kg)		High-speed machinery steel	Быстрорежущая машинная сталь	Maschinen-Schnellarbeitsstahl
	Teeth per inch	Количество зубцов на дюйм	Anzahl der Zähne pro Zoll		High speed steel - TiN coated	Быстрорежущая сталь покрыта нитридом титана	Schnellarbeitsstahl mit Titanitridbeschichtung
	Wedge size	Размеры клина	Abmessungen des Keils		High speed cobalt steel	Быстрорежущая сталь с кобальтом	Kobalt-Schnellarbeitsstahl

















<b>CARBON</b>	Carbon steel	Графит	Kohlenstoffstahl	<b>ALTi A380</b>	Titanium alloy	Сплав титана	Titanlegierung
<b>HCS</b>	Carbon steel	Углеродистая сталь	Kohlenstoffstahl	<b>ASME</b>	ASME standard steel	Сталь по стандарту ASME	Stahl nach ASME-Standard hergestellt
<b>AL</b>	Aluminium	Алюминий	Aluminium		Dry wood	Сухая древесина	Trockenes Holz
<b>65 Mn</b>	Manganese spring steel	Пружинная марганцевая сталь 65	Mangan-Federstahl		Plywood	ДСП	Furniersperrholz
<b>Cr</b>	Chrome steel	Хромированная сталь	Chromstahl		Laminate	Ламинат	Laminat
<b>CrV</b>	Chrome-vanadium steel	Хромованадиевая сталь	Chrom-Vanadium-Stahl		Steel	Сталь	Stahl
<b>CrV 6140</b>	Special chrome-vanadium steel 6140	Хромованадиевая сталь 6140	Chrom-Vanadium-Spezialstahl 6140		Concrete	Бетон	Beton
<b>S2</b>	Special chrome-vanadium steel S2	Хромованадиевая сталь S2	Chrom-Vanadium-Spezialstahl S2	<b>GENUINE HICKORY</b>	Hickory handle	Рукоятка из орешника	Handgriff aus Hickoryholz
<b>CrMo</b>	Chrome-molybdenum steel	Хромомолибденовая сталь	Chrom-Molybdän-Stahl	<b>GRP</b>	Fiberglass reinforced plastic	Усиленный волокном пластик	Faserverstärkter Verbundstoff
<b>CrMo SCM-440</b>	Chrome-molybdenum steel SCM-440	Хромомолибденовая сталь CSM440	Chrom-Molybdän-Stahl SCM-440	<b>FRP</b>	Fiberglass reinforced plastic	Усиленный стекловолокном пластик	Faserverstärkter Kunststoff
<b>Cr-V-Mo</b>	Chrome-vanadium-molybdenum steel	Хром-ванадий-молибденовая сталь	Chrom-Vanadium-Molybdän-Stahl	<b>PTFE</b>	Politetrafluoroetylen	Полимер тетрафторэтилена	Polytetrafluorethylenpolymer
<b>9Cr2</b>	Chrome steel 9Cr2	Хромованадиевая сталь 9Cr2	Chromstahl 9Cr2	<b>HDPE</b>	High-density polyethylene	Полиэтилен высокой плотности	Polyethylen hoher Dichte
<b>GR15</b>	Steel GR15	Сталь GR15	GR15 Stahl	<b>PE</b>	Polyethylene	Полиэтилен	Polyethylen
<b>STAINLESS</b>	Stainless steel	Нержавеющая сталь	Edelstahl	<b>PET</b>	Polyethylene terephthalate	Полиэтилентерефталат	Polyethylenerephthalat
<b>TCT</b>	Tungsten carbide	Карбид вольфрама	Wolframcarbide	<b>PP</b>	Polypropylene	Полипропилен	Polypropylen
<b>METAL</b>	Metal body/guide	Металлический корпус/направляющая	Metallkörper / Führung	<b>PCW</b>	Polyvinyl chloride	Поливинилхлорид	Polyvinylchlorid
<b>BI-METAL</b>	Bimetal material	биметалл	Bimetall	<b>ABS PP</b>	Product made of ABS and PP	Товар изготовлен из АБС-пластика и полипропилена	Produkt aus ABS und PP
<b>Zn-Cu</b>	Brass	Латунь	Messing	<b>ABS</b>	ABS plastic	АБС пластик	Kunststoff ABS
<b>Cu (Fe)</b>	Copper coated steel wire	Стальная омеднённая проволока	Verkupferter Stahl-draht	<b>RUBBER</b>	Rubber surface	Резиновая поверхность	Gummioberfläche

	Polyester	Полиэфир	Polyester
	No adhesive	Без клея	Ohne Klebstoff
	No silicone	Не содержит силикона	Ohne Silikon

	Clamping device for pipe joints PEX-AL-PEX	Трубный зажим PEX-AL-PEX	Crimpwerkzeug für PEX-AL-PEX-Rohrverbindungen
	Clamping device for pipe joints PE-RT-AL-PE-RT	Трубный зажим PE-RT-AL-PE-RT	Crimpwerkzeug für PE-RT-AL-PE-RT-Rohrverbindungen
	Clamping force	Зажимная сила	Klemmkraft



Functionality | Функциональность | Funktionalität









































	Heavy duty	Повышенная прочность	Besonders langlebig
	Increased strength of socket wall	Повышенная прочность стенок головки	Erhöhte Stärke der Kappenwand
	Rotary element	Крутящий момент	Rotierendes Element
	AUTO STOP function	Устройство с функцией АВТОСТОП	Das Gerät ist mit AUTO STOP ausgestattet
	Laser welded diamond saws	Лазерная пайка алмазов	Lasergeschweißte Diamantsegmente für den Scheibenkörper
	Max. load	Максимальная нагрузка, кг.	Maximale Belastung
	Maximum acceptable load per surface area	Максимально допустимая нагрузка на поверхность	Maximal zulässige Belastung der Oberfläche
	Maximum acceptable longitudinal load	Максимально допустимая нагрузка по длине	Maximal zulässige Belastung pro Länge
	Maximum acceptable vertical load	Максимально допустимая вертикальная нагрузка	Maximal zulässige vertikale Belastung
	Breaking force	Максимальная нагрузка на обрыв	Reißkraft
	Max. size of work-piece	Максимальная величина обрабатываемого предмета	Maximale Größe des Werkstücks
	Max. size	Макс. Размеры обрабатываемого предмета	Maximale Abmessungen des Werkstücks
	Min. height of saddle	Максимальная высота седла	Minimale Höhe des Sattels
	Use temperature range	Температурный диапазон использования	Bereich der Anwendungstemperaturen
	Size and scope of possible retention of durability	Масштаб и пределы возможного сохранения прочности	Größe und der Bereich der möglichen Festigkeitserhaltung
	Possible installation time with self-adhesive strip	Примерное время наклеивания на самоклеющуюся ленту	Mögliche Montagezeit auf dem Selbstklebestreifen



















	Matrix type for clamping device PEX-AL-PEX	Тип матрицы для зажима PEX-AL-PEX	Matrixtyp für PEX-AL-PEX-Crimpzange
	Work time	Режим работы	Arbeitsbereich (Zeit)
	Recommended cutting range	Рекомендуемая область среза	Empfohlener Schneidbereich
	Recommended cutting range	Рекомендуемая область среза	Maximaldurchmesser des zu schneidenden Werkstücks
	Recommended cutting range	Рекомендуемая область среза	Empfohlener Schneidbereich
	3 polished cutting edges	Зубцы с тремя режущими плоскостями	Zähne mit drei Schneidkanten
	Rotor blade	Оборотное лезвие	Rotierende Klinge
	Working range	Рабочий диапазон	Arbeitsbereich
	Changeable teeth - quantity per inch	Непостоянное количество зубцов	Variable Zahndichte
	Drill point angle	Угол острия сверла	Spitzenwinkel des Bohrers
	Changeable blade	Сменное лезвие	Austauschbare Klinge
	Serrated jaws	Зубчатая поверхность лезвия	Gezahnte Klinge
	6 carbide blades	6 твердосплавных роликов	6 Hartmetallklingen
	Number of spanners in the set	Количество ключей в наборе	Anzahl der Schlüssel im Set
	Changeable bits	Сменные насадки	Austauschbare Spitzen
	Lubrication required	Необходима смазка	Zur Schmierung





	Rectangle section	Прямоугольное сечение	Rechteckiger Querschnitt		For aluminium rivets	Для алюминиевых заклепок	Für Aluminiumnieten
	Half round section	Полукруглое сечение	Halbkreisförmiger Querschnitt		For copper rivets	Для медных заклепок	Für Kupfernieten
	Round section	Круглое сечение	Kreisförmiger Querschnitt		For stainless steel rivets	Для заклепок из нержавеющей стали	Für Edelstahl-nieten
	Three square section	Треугольное сечение	Dreieckiger Querschnitt		For cutting aluminium pipes	Для резки алюминиевых труб	Zum Schneiden von Aluminiumrohren
	Square section	Квадратное сечение	Quadratischer Querschnitt		For cutting copper pipes	Для резки медных труб	Zum Schneiden von Kupferrohren
	Size and section	Размер и форма в разрезе	Größe und Form des Querschnitts		For cutting polyethylene pipes	Для резки полиэтиленовых труб	Zum Schneiden von Polyethylenrohren
	Soft touch handle	Прорезиненная рукоятка	Griff mit einer weichen, rutschfesten Beschichtung		For cutting polypropylene pipes	Для резки полипропиленовых труб	Zum Schneiden von Polypropylenrohren
	Ergonomic design	Исключительно удобные	Besonders bequem		For cutting PVC pipes	Для резки труб из ПВХ	Zum Schneiden von PVC-Rohren
	For precision work	Исключительно точные	Besonders präzise		Pocket quantity	Количество кармашков	Anzahl der Taschen
	External circlip pliers	Для колец Сергера внешние	Für Seeger-Ringe für Rollen		Waterproof rubber base	Водонепроницаемое резиновое основание	Wasserdichte Gummibasis
	Internal circlip pliers	Для колец Сергера внутренние	Für Seeger-Ringe für Öffnungen		Steel insert reinforcement	Широко открываемый, с усиленными металлическими вставками	Metallversteifungseinsätze
	Diamond coated segments	Сегменты покрытые алмазом	Diamantbeschichtete Segmente		Reinforced frame	Усиленная рама	Verstärkter Rahmen
	M14 threaded fixing	Тип крепления M14	Befestigung M14		Toolbag with wheels	С колесами	Tasche mit Rädern
	M14 threaded fixing	Тип крепления M14	Befestigung M14		Toolbag with fold away handle	Выдвижная рукоятка	Tasche mit ausziehbarem Griff
	Self - adhesive	Тип крепления - на липучку	Klettverschluss-Befestigung		Box	Кейс	Truhe
	For angle grinder	Для ушм	Für Winkelschleifer		Aluminium box	Алюминиевый кейс	Aluminiumtruhe
	For power drill	Для дрели	Für Bohrer		Adjustable nozzle	Регуляция сопла	Einstellbare Düse
	For cutting aluminium cable	Для резки алюминиевых кабелей	Zum Schneiden von Aluminiumdrähten		Mounting holes every 1m	Монтажные отверстия через 1 м	Montageösen alle 1 Meter
	For cutting copper cable	Для резки медных кабелей	Zum Schneiden von Kupferdrähten		Number of teeth	Количество зубцов	Anzahl der Zähne

	Number of teeth in a ratchet	Количество зубьев в трещотке	Anzahl der Zähne in der Ratsche		Flat screwdriver	Плоский шлиц	Schlitzschraubendreher
	Ball bearings	Шариковые подшипники	Wälzlager		Phillips screwdriver	Шлиц Phillips	Phillips-Schraubendreher
	Ratio	Планетарная передача	Übersetzung		Torx screwdriver	Шлиц Torx	Torx-Schraubendreher
	Max. rotation	Максимальные обороты	Maximale Drehzahl Max.		Security Torx screwdriver	Шлиц Torx с отверстием	Torx-Schraubendreher mit Loch
	Power	Мощность	Nennleistung		Security Torx screwdriver	Шлиц Pozidrive	Pozidriv-Schraubendreher
	Maximum torque	Максимальный вращающий момент	Maximales Drehmoment		Hexagonal socket	Шестигранный шлиц (мама)	Innensechskant
	Maximum air pressure	Максимальное давление воздуха	Maximaler Luftdruck		Hexagonal shank	Шестигранный шлиц (папа)	Sechskantspitze
	Required air flow	Требуется течение воздуха	Erforderlicher Luftstrom		1/4" bit socket	Насадка HEX 1/4"	Innensechskant 1/4 "
	Small weight of device	Небольшая масса устройства	Geringes Gewicht des Gerätes		Socket holder	Держатель для головок	Knarrenhalter
	Impact mechanism with double hammer clutch	Ударный механизм с двойной молотковой муфтой	Schlagwerk mit Doppelhammerkupplung		Blade for cutting cables	Лезвие для резки кабеля	Kabelschneideklinge
	Compact size of device	Компактный размер устройства	Kompakte Größe des Geräts		Adjustment	Регуляция	Einstellung
	Rotational speed of device	Скорость вращения устройства	Drehzahl des Geräts		Crimping pliers	Щипцы для зажима кабелей	Backen zum Crimpen der Spitzen
	Size of threaded connection	Размер резьбы соединительной детали	Gewindegröße des Verbinders		Deburring tip	Наконечник для удаления заусенцов	Spitze zum Entgraten
	Length of pumping hose	Длина шланга для накачивания	Länge des Pumpschlauches		Deburring tip	Наконечник для удаления заусенцов	Spitze zum Entgraten
	Universal female quick-release-coupling	Быстросъемный штуцер типа мама универсальный	Universal-Schnellanschluss weiblich		Magnet	Магнит	Magnet
	EURO type male quick-release-coupling	Быстросъемный штуцер типа папа типа EURO	EURO-Schnellanschluss männlich		Filament type	Тип элемента накаливания	Glühwendeltyp
	Quick-release-coupling mounting system	Система крепления с использованием быстрого соединения	Befestigungssystem für Schnellanschlüsse		Operating mode	Режим работы	Betriebsarten
	Working power starting power	Мощность	Leistungsverbrauch in: Ruhe- und Arbeitszustand		LED backlight	LED-подсветка	LED-Beleuchtung
	Piezo-electric power	Пьезоподжиг	Piezoelektrische Stromversorgung		Colour rendering index	Коэффициент цветопередачи	Farbwiedergabeindex















	Energy class	Энергетический класс	Energieklasse		Low-pressure spray gun	Краскопульт низкого давления	Niederdruck-Spritzpistole
	Colour of light	Окраска света	Lichtfarbe		Energy-efficient low-pressure spray gun	Краскопульт низкого давления (небольшое использование материала)	Niederdruck-Spritzpistole mit geringem Verbrauch
	Movement sensor	Датчик движения	Bewegungsmelder		Maximum speed	Максимальные обороты	Maximale Drehzahl
	Angle of lighting	Угол свечения	Leuchtwinkel		Left/Right rotation	Обороты лево/право	Links- / Rechtsdrehung
	Luminous power	Мощность светового потока	Leistung des Lichtstroms		Cable length	Длина силового кабеля (провода)	Länge des Netzkabels
	Battery type and capacity	Тип и ёмкость аккумулятора	Akku-Typ und -Kapazität		Safety catch	Защита от неконтролируемого выстрела	Schutz vor unkontrolliertem Schießen
	Zoom function - enables focusing and scattering of light beam	Функция ZOOM - концентрация и рассеяние светового пучка	Zoomfunktion - ermöglicht die Konzentrierung und Streuung eines Lichtstrahls		Driving power adjustment	Регулировка силы забивания	Einstellung der Einschlagkraft
	SOS signal	Сигнал СОС	SOS-Signal		Safety switch	Выключатель безопасности	Sicherheitsschalter
	USB charging	Зарядка по USB	Aufladen via USB		LCD display	ЖК дисплей	LCD-Display
	Product made of special aluminium alloy used in aviation industry	Продукт изготовлен из специального алюминиевого сплава, который используется в авиационной промышленности	Das Produkt besteht aus einer speziellen Aluminiumlegierung, die in der Luftfahrtindustrie verwendet wird		LED	Диоды LED	LED-Diode
	Power of illumination	Мощность освещения	Leuchtleistung		Accuracy of measurement	Уровень точности	Messgenauigkeit
	High power illumination	Освещение высокой мощности	Hochleistungsbeleuchtung		Work at different angles	Возможность работы при разных углах	Möglichkeit, in verschiedenen Winkeln zu arbeiten
	Quantity and type of batteries	Тип и количество необходимых батарей	Art und Anzahl der benötigten Batterien		Tripod	Штатив	Stativ
	Work at straight angle	Работа под прямым углом	Arbeiten im rechten Winkel		Rotation head	Плавающая головка	Rotation-Drehkopf
	Length	Длина	Länge		5/8 thread	Резьба 5/8	5/8 Gewinde
	Connection points	Пункты соединений	Verbindungspunkte		Protective goggles	Очки защитные	Schutzbrille
	Spray gun nozzle diameter	Диаметр сопла краскопульта	Durchmesser der Spritzpistolendüse		Self leveling	Самовыравнивание	Selbstnivellierung
	High-pressure spray gun	Краскопульт высокого давления	Hochdruck-Spritzpistole		Work distance	Расстояние работы	Arbeitsabstand
					Laser pointer	Лазерный указатель	Laserpointer
					Rubber handle	Прорезиненная рукоятка	Gummigriff

	Scriber with TCT	Углеродистый стержень	Scriber mit Hartmetall		MMA/TIG welding type	Вид сварки MMA/TIG	MMA/WIG-Schweißart
	Scriber with TCT	Углеродистый стержень	Hartmetallklinge		TIG PULSE function	Функция TIG PULSE	WIG PULSE Funktion
	Tungsten tip	Товар с вольфрамовыми лезвиями	Produkt mit Wolframklingen		MMA welding	Сварка методом MMA	MMA-Schweißen
	Clip	Клипса	Klammer		ARC FORCE function	Функция ARC FORCE	ARC FORCE Funktion
	Hardened shackle	Закаленный корпус	Gehärteter Bügel		HOT AIR function	Функция HOT AIR	HOT AIR Funktion
	Number of keys	Количество ключей	Anzahl der Schlüssel		ANTI STICK function	Функция ANTI STICK	ANTI STICK Funktion
	Welding position	Позиция варки	Schweißposition		Fan function	Функция вентилятора	Lüfterfunktion
	Quick hose connector	Коннектор сквозного быстрого соединения	Schneller Durchgangsstecker		MMA electrode	Электрод MMA	MMA-Elektrode
	Max sprinkle area	Макс. поверхность полива	Maximale Benetzungsfläche		TIG electrode	Электрод TIG	WIG-Elektrode
	Sprinkle angle	Угол полива	Sprühwinkel		Use indoor	Использовать внутри помещений	Zur Nutzung in Innenräumen bestimmt
	Thermal fuse	Термический предохранитель	Thermische Sicherung		May be used outdoors, humidity resistant	Можно использовать снаружи, устойчивы к воздействию влаги	Kann im Freien verwendet werden, resistent gegen Feuchtigkeit
	Max voltage	Макс. Допустимое напряжение	Maximal zulässige Spannung		May be used outdoors, humidity resistant, UV resistant	Можно использовать снаружи, устойчивы к воздействию влаги, устойчивы к воздействию УФ-лучей	Kann im Freien verwendet werden, resistent gegen Feuchtigkeit und UV-Strahlung
	Max permissible current with cable retracted	Макс. ток при смотанном кабеле	Maximaler Strom mit aufgerolltem Verlängerungskabel		All weather product	Демисезонный товар	Ganzjahresprodukt
	1000 V certificated	Допуск до 1000 В	1000 V zertifiziert		For working in the rain	Влагостойкие	Wasserfest
	Maximum acceptable use voltage	Максимально допустимое рабочее напряжение	Maximal zulässige Anwendungsspannung		Self-adhesive	Самоклеющийся	Selbstklebend
	Maximum acceptable use pressure	Максимально допустимое рабочее давление	Maximal zulässiger Betriebsdruck		Spot light	Точечное освещение	Spotbeleuchtung
	Number of cutting edges	Количество режущих кромок	Anzahl der Schneidkanten		Flood light	Рассеивающий свет	Streulicht
	Max diameter	Макс. Диаметр	Maximaler Durchmesser		Dual light	Два вида освещения	Zwei Arten von Beleuchtung
	Minigrinder	Минишлифмашина	Mini-Schleifer		Hook	Крючок	Haken
	Krypton bulb	Криптоновая лампа	Krypton Glühlampe		Hook	Крючок	Haken



	For oil paints and lacquers	Для масляных красок и лаков	Für Ölfarben und Lacke
	For acrylic, waterborn paints	Для акриловых красок на водной основе	Für wasserverdünnbare Acrylfarben
	Percentage share bristles with maximum lenght	Процент щетинок с максимальной длиной	Prozentsatz der Borsten mit maximaler Länge
	Durable, permanent ink	Стойкая перманентная тушь	Permanent dauerhafte Tinte
	Small bit	Маленькая насадка	Kleine Spitze
	Inverter intended for charging batteries of different vehicles	Выпрямитель предназначен для зарядки аккумуляторов транспортных средств разного типа	Gleichrichter zum Laden von Batterien verschiedener Fahrzeuge
	Range of Ah batteries, for which the inverter is intended	Диапазон Ач аккумуляторов, для которых предназначен выпрямитель	Ah-Bereich der Akkus, für die der Gleichrichter bestimmt ist
	Charging current	Зарядный ток	Ladestrom
	12V socket	Гнездо 12В	12V Buchse
	Starting aid	Управление запуском	Starthilfe
	For various surfaces such as dry wood, steel, concrete	Предназначено для различных поверхностей, в т.ч. сухое дерево, сталь, бетон	Geeignet für verschiedene Oberflächen, u. a. trockenes Holz, Stahl, Beton
	Warranty for material defects	Гарантия на изъяны материала	Garantie für Sachmängel
	Ecologically manufactured without solvents and mostly from organic materials	Произведены экологическим способом без использования растворителей, преимущественно из органических материалов	Ökologisch hergestellt, ohne Verwendung von Lösungsmitteln und großteils aus organischen Materialien
	Low noise emission during use	Низкий уровень шума, создаваемого изделием при использовании	Niedriger Geräuschpegel, den das Produkt während des Gebrauchs erzeugt
	Solvent-free	Без растворителей	Frei von Lösungsmitteln
	Sold on spool	Продается на катушке	Auf Spule verkauft
	MAXimum burst pressure	Максимальное разрывное давление	Maximaler Berstdruck
	Torsion resistance	Стойкость к сворачиванию	Torsionswiderstand

	UV radiation resistance	Стойкость к УФ излучению	Beständigkeit gegen UV-Strahlen
	Algae build-up resistance	Стойкость к осаживанию водорослей	Beständigkeit gegen Algenablagerung
	Resistance to high and low temperatures	Стойкость к высоким и низким температурам	Beständigkeit gegen hohe und niedrige Temperaturen
	Do not contain cadmium, bar, lead, phthalates	Не содержит кадмия, бария, свинца, фталатов	Frei von Cadmium, Barium, Blei, Phthalaten
	Anticipated waiting time	Ожидаемое время ожидания	Voraussichtliche Wartezeit

Power tools | Электрoинструменты | Elektrowerkzeuge

	Voltage/frequency	Напряжение, частота	Nennspannung / Frequenz
	Insulation class II	Инструмент класса II	Klasse II Werkzeug
	Cable length	Длина силового кабеля (провода)	Länge des Netzkabels
	Case	Кейс	Truhe
	Nominal voltage	Номинальное напряжение	Nennspannung
	Torque	Вращающий момент	Drehmoment
	Rotations left/right	Обороты влево/вправо	Links-/Rechts-Drehung
	Drill chuck diameter	Диаметр сверильного патрона	Durchmesser des Bohrfutters
	Number of clutch degrees	Количество ступеней муфты	Anzahl der Kupplungsstufen
	Rotational speed	Скорость вращения	Drehzahl
	Type and number of batteries	Вид и количество	Art und Anzahl der Batterien
	Indicative duration of charging battery	Ориентировочное время зарядки аккумулятора	Ungefähre Ladezeit des Akkus
	Airflow velocity	Скорость потока воздуха	Die Geschwindigkeit des Luftstroms
	Working length	Длина рабочей части	Länge des Arbeitsteils

	Spacing of teeth	Расстояние зубьев	Zahnabstand
	Maximum wood cutting thickness	Максимальная толщина резки дерева	Maximale Dicke des Holzschnitts
	Maximum metal cutting thickness	Максимальная толщина резки металла	Maximale Dicke des Metallschnitts
	Circular saw diameter	Диаметр дисковой пилы	Durchmesser der Kreissäge
	Laser	Лазер	Laser
	Cutting function	Фнкция разрезания	Schneidefunktion
	Blade holder type	Тип держателя полотна	Art des Sägeblatthalters
	Leg adjustment range	Диапазон регулировки стопы	Fußverstellbereich
	Disc mounting-thread M14	Крепление диска-резьба M14	Befestigung der M14-Gewindescheibe













	Width regulation	Регулировка ширины	Breitenverstellung
	Width adjustment	Вращающийся элемент	Rotierendes Element
	Easy-fix system	Система простого крепления	Einfaches Montagesystem
	Number of ventilation holes	Количество вентиляционных отверстий	Anzahl der Lüftungsöffnungen
	Removable filter in the helmet	Поднимаемый фильтр в передней части	Anhebbarer Filter im Helm
	Sensitivity and delay adjustment	Регулировка чувствительности и задержки	Empfindlichkeits- und Verzögerungseinstellung
	Shade range adjustment	Регулировка области затемнения	Einstellung des Verdunkelungsbereichs
	Shade range and filter size	Область затемнения и размер фильтра	Verdunkelungsbereich und Filtergröße
	UV/IR protection	Защита от ультрафиолетового и инфракрасного излучения	UV-/IR-Strahlenschutz

Personal protective equipment | Рабочая одежда  
Persönliche Schutzausrüstungen

	Product certified by Central Institute for Labour Protection – National Research Institute	Продукт сертифицирован в Центральном институте охраны труда – Государственный исс ледовательский институт	Vom Centralny Instytut Ochrony Pracy – Państwowy Instytut Badawczy (Zentrales Institut für Arbeitsschutz – Staatliches Forschungsinstitut) zertifiziertes Produkt	
		Composition of material	Состав материала	Materialzusammensetzung
		Product measurements	Размер артикула	Produktabmessungen
		Length 130 cm with possibility of reduction	Длина 130 см с возможностью укорочения	Länge 130 cm mit Verkürzungsmöglichkeit
		Double, adjustable fixing strap	Двойные регулируемые крепления	Doppelter, verstellbarer Haken
		Gloves with inner flock lining	Рукавицы покрыты изнутри флоком (хлопковой пылью)	Innenseite der Handschuhe ist mit Flock bedeckt
		Vertical angle adjustment	Регулировка наклона линз	Vertikale Winkleinstellung
		Horizontal length adjustment	Регулировка длины дужек	Längseinstellung der Länge
		Reversible	Металлическая сетка	Metallgitter
		Steel mesh instead of lenses	Двухсторонний	Doppelseitig

	Number of light sensors	Количество датчиков уровня освещения	Anzahl der Belichtungssensoren
	Filter test	Тест фильтра	Filtertest
	Auto on/off	Автоматическое включение/выключение	Automatisches Ein- und Ausschalten
	Solar battery powered	Питание от солнечной батареи	Versorgung mit Solarbatterie
	Lithium battery powered	Питание от литиевой батареек	Versorgung mit Lithiumbatterie
	Headgear adjustment	Регулировка оголовья	Kopfeinstellung
	Optical class	Оптический класс	Optische Klasse
	Shade range adjustment	Регулировка области затемнения	Einstellung des Verdunkelungsbereichs
	Sensitivity adjustment	Регулировка чувствительности	Empfindlichkeitseinstellung
	Delay adjustment	Регулировка задержки	Verzögerungseinstellung
	Protective glass height	Высота защитного экрана	Höhe des Schutzglases



	For working in low temperatures	Для работ при низких температурах	Für das Arbeiten bei niedrigen Temperaturen		Width adjustment in waist by means of special structure with elastic tape	Регулировка ширины в поясе с помощью специальной конструкции с эластичной лентой	Weitenverstellung in der Taille durch eine spezielle Konstruktion mit Gummizug
	Reflective material	Светоотражающие элементы	Reflektierendes Material		Elastic material with stretch	Эластичный материал с добавкой стрейч ткани	Elastisches Material mit Zusatz von Stretch
	Reinforced on the palm and fingers	Махровый материал поглощающий пот	Frottee für die Absorption von Schweiß		Protection against electromagnetic radiation	Защита от электромагнитного излучения	Schutz vor elektromagnetischer Strahlung
	Reinforced on the palm and fingers	Армирование на захватной части и на пальцах	Verstärkungen am Griffteil und an den Fingern		Pocket quantity	Количество кармашков	Anzahl der Taschen
	Non-slip silicone mesh	Силиконовая нескользящая сетка	Rutschfestes Silikon-Netz		Knee protector pockets	Карманы для наколенников	Taschen für Kniebeschützer
	Soft pad on the palm	Мягкая подушка на захватной стороне	Weiches Kissen am Griffteil		Anti pilling	Материал не лохматится	Fusselfreier Stoff
	Reflective elements	Светоотражающие элементы	Reflektierende Elemente		Soft comfort	Мягкий материал	Weiches Material
	High-visibility material	Материал с высокой видимостью	Material mit hoher Sichtbarkeit		Ring spun cotton	Хлопок типа ring-spun	Ringspun Baumwolle
	Open fingertip gloves	Перчатки без пальцев	Fingerlose Handschuhe		Water proof	Водостойкий материал	Wasserdichtes Material
	Anti-vibration gloves	Антивибрационные рукавицы	Anti-Vibrationshandschuhe		Breathable	Дышащий материал	Atmungsaktives Material
	Anti-static gloves	Антистатические перчатки	Antistatische Handschuhe		Thermal	Теплостойкий материал	Thermisches Material
	Highest resistance to blade cutting (resistance level 5)	Самая высокая степень стойкости к разрезанию лезвием	Höchste Schnittfestigkeit		Moisture transferring material	Материал, выводящий влагу	Material, das Feuchtigkeit transportiert
	High visibility	Высокая видимость	Hohe Sichtbarkeit		Wind breaker	Ветропроницаемый материал	Winddichtes Material
	Protection from low temperature (down to -50°C)	Защита от регулировки диапазона тонирования низкой температурой (до -50°C)	Schutz vor Tieftemperaturregulierung (bis -50 °C)		Water-proof material	Водостойкий материал	Wasserfestes Material
	Moisture transportation	Влагоотводящий материал	Material, das Feuchtigkeit ableitet		Tear-proof material	Материал стойкий к разрыву	Reißfestes Material
	Reflective elements	Световозвращающие элементы	Reflektierende Elemente		Lightweight material	Ткань небольшого веса	Material mit geringem Gewicht
	Stretch inserts "4-way elastic" extensibility in 4 directions	Вставки из материала "4-way elastic" (растяжимость в 4 направлениях)	Streckeinsätze "4-way elastic" (Dehnbarkeit in 4 Richtungen)		Made of polyvinyl chloride	Изготовлено из поливинилхлорида	Polyvinylchlorid
	Anti-slip tape in waist	Противоскользкая лента в поясе	Anti-Rutsch-Band in der Taille		Made of latex	Изготовлено из латекса	Aus Latex hergestellt
					Made of nitril	Изготовлено из нитрила	Aus Nitril hergestellt

	Made of EVA, latex and TPR	Изготовлены из EVA, латекса и TPR	Aus EVA, Latex und TPR		Antistatic footwear	Антиэлектростатические свойства	Antistatisches Schuhwerk
	Made of EVA and latex	Изготовлены из EVA и латекса	Aus EVA und Latex		Energy absorption in heel area	Поглощение энергии в пяточной части	Energieaufnahme im Fersenbereich
	Made from polyurethane	Изготовлено из полиуретана	Aus Polyurethan		Limited permeability and water absorption	Ограниченное пропускание и поглощение воды	Begrenzte Durchlässigkeit und Wasseraufnahme
	Anti-slip finish	Противоскользящая отделка	Rutschfeste Oberfläche		Resistance to puncture of 1100N, rugged sole	Устойчивость к проколу с силой 1100 н, рифлёная Подошва	Durchschlagfestigkeit von 1100N, robuste Sohle
	Very thick acrylic lining	Очень толстый акриловый утеплитель	Sehr dicke Acrylisolierung		Resistance to puncture of 1100N	Устойчивость к проколу с силой 1100 н	Durchschlagfestigkeit von 1100N
	UV filter	Ультрафиолетовый фильтр	UV-Filter		Resistant to fuel oil	Устойчивость к дизельному топливу	Beständig gegen Heizöl
	Weight per meter square	Плотность материала	Materialgewicht		Slip resistance on ceramic surface	Устойчивость к скольжению на керамическом основании	Rutschfestigkeit auf keramischer Oberfläche
	Sun protective factor	Солнцезащитный фактор	Blendschutzfilter		Slip resistance on steel and ceramic surface	Устойчивость к скольжению на керамическом и стальном основании	Rutschfestigkeit auf Stahl- und Keramikoberfläche
	Mechanical durability class	Класс механической стойкости	Mechanische Widerstandsklasse		Composite toe cap - protects against impact of energy of 200J	Композитный защитный носок – обеспечивает защиту пальцев ступни от удара с энергией 200 дж	Verbundstoff-Zehenschutzkappe - schützt vor Energieeinwirkung von 200J
	Scratch resistance	Стойкость к царапинам	Kratzfestigkeit		Steel toe cap - protects against impact of energy of 200J	Стальной защитный носок – обеспечивает защиту пальцев ступни от удара с энергией 200 дж	Stahl-Zehenschutzkappe - schützt vor Energieeinwirkung von 200J
	Misting resistance	Стойкость к запотеванию	Beständigkeit gegen Beschlagen		No toe cap	Без подносок	Keine Zehenkappe
	Guaranteed mechanical resistance from -5°C ±2°C to +55°C ±2°C	Гарантированная механическая стойкость от -5°C ±2°C до +55°C ±2°C	Garantierte mechanische Beständigkeit von -5 °C ± 2 °C bis +55 °C ± 2 °C		Metal free	Отсутствие металлических элементов	Metallfrei
	Mechanical resistance	Класс защиты	Schutzklasse		Rubber sole	Подошва выполнена из резины	Gummisohle
	Visibility class	Класс видимости	Sichtbarkeitsklasse		Dual density polyurethane sole	Подошва изготовлена из двухплотностного Полиуретана	Polyurethansohle mit doppelter Dichte
	Noise damping index	Коэффициент шумоподавления	Schalldämpfungs-koeffizient		Homogeneous density polyurethane sole	Подошва изготовлена из одноплотностного Полиуретана	Polyurethan-Sohle mit homogener Dichte
	Product in compliance with the EN 388 norm	Соответствует требованиям стандартов EN 388	Das Produkt erfüllt die Anforderungen der Norm EN 388		Sole resistance to high temperature in a short-term contact (up to 300°C/1min)	Стойкость подошвы на воздействие высокой температуры при кратковременном контакте (до 300°C/1мин)	Sohlenbeständigkeit gegen hohe Temperatur im Kurzzeitkontakt (bis 300 °C/1min)
	Personal Protective Equipment Cat. I	Средство индивидуальной защиты первой категории (может быть также второй и третьей)	Die erste Kategorie der persönlichen Schutzausrüstung (kann auch zweite und dritte sein)		Made of leather	Изготовлены из кожи	Aus Leder
	H - Height C - Chest size W - Waist size	H - рост C - обхват груди W - обхват бедер	H - Körpergröße C - Brustumfang W - Taillenumfang				
	Heel covered up	Закрытая область пятки	Geschlossener Fersenbereich				

	Made of high-quality trekking facing leather "crazy horse"	Изготовлены из высококачественной облицовочной трекинговой кожи „crazy horse“	Aus hochwertigem, Trekking-Vollleder "Crazy Horse"
	Lining and insert made of leather	Подкладка и стелька изготовлены из кожи	Futter und Einlegesohle aus Leder
	Antistatic footwear	Антиэлектростатические свойства	Antielektrostatische Eigenschaften
	Energy absorption in heel area	Поглощение энергии в пяточной части	Energieaufnahme im Fersenteil
	Resistant to fuel oil	Устойчивость к дизельному топливу	Beständigkeit gegen Diesel
	Entire footwear made of plastic, water-proof	Обувь полностью изготовлена из пластмассы, водостойкая	Gesamtes Schuhwerk aus Kunststoff, wasserdicht
	Heel covered up	Закрытая область пятки	Ferse bedeckt
	Slip resistance on ceramic surface	Устойчивость к скольжению на керамическом основании	Rutschfestigkeit auf Keramikböden
	Slip resistance on ceramic and steel floor	Противоскользящие свойства на керамической и стальной поверхности	Rutschfestigkeit auf Keramik- und Stahlböden
	Rain boots	Непромокаемая обувь	Regenschuhe
	Outsole made from high-quality thermoplastic rubber	Подошва изготовлена из термостатической резины высокого качества	Sohle aus hochwertigem Thermostatgummi
	Sales unit - 10 pairs	Единица продажи - 10 пар	Verkaufseinheit - 10 Paare
	Sales unit - 10 pairs	Единица продажи - 10 пар	Verkaufseinheit - 10 Paare



# PROLINE®



[proline-tools.com.pl](http://proline-tools.com.pl)

# P

roline is the most recognisable Polish brand of hand tools\*. As many as 75% of those who voted for Proline in the Consumer's Laurel 2018 awards claim they would recommend products from this brand to their friends.

Thanks to such good opinions, Proline tools were awarded the Silver Consumer's Laurel in the hand tools category in 2018 for the second time in a row. What end-users said proves that Proline products make it easier to perform a number of tasks of varying difficulty. They are characterised by their durability and very good, professional-grade quality. It's worth noting that tools under the Proline brand were made available to Polish buyers in 1997 for the first time. The first products were soft-touch screwdrivers. Over the next twenty years, Proline's offer was successfully expanded. Today, it numbers nearly 5000 high-quality products successfully satisfying the tool needs of professionals and all those who independently carry out repairs and upgrades. No other Polish brand of hand tools can boast of such a wide range.

When choosing Proline, the end user gets a product of the highest quality, which means that all kinds of work can be done faster and more conveniently. An owner of a shopping outlet choosing Proline gains access to a wide range, special sales support campaigns, can participate in numerous training options, as well as join the unique Voyager loyalty program.

\* According to data collected as part of the 2018 Consumer's Laurel award.

Proline - самая узнаваемая польская марка ручных инструментов\*. Не менее 75% участников, которые голосовали за Proline в номинации конкурса «Признание потребителей 2018», утверждают, что порекомендуют продукты этого бренда своим друзьям. Благодаря такому хорошему отзыву, инструменты Proline во второй раз подряд были удостоены премии «Серебряный потребитель» в категории «Ручные инструменты» в 2018 году. Мнение конечных пользователей доказывает, что продукты Proline облегчают выполнение ряда задач различной сложности. Они характеризуются своей прочностью и очень высоким качеством профессионального уровня. Стоит также отметить, что инструменты под маркой Proline впервые стали доступны для польских покупателей в 1997 году. Первыми продуктами были отвертки с мягкой рукояткой. В течение следующих двадцати лет предложение Proline успешно расширялось. На сегодняшний день насчитывается около 5000 высококачественных продуктов, успешно используемые профессионалами и всеми, кто самостоятельно выполняет ремонт и обновление. Ни один другой польский бренд ручного инструмента не может похвастаться таким широким ассортиментом.

Выбирая Proline, конечный пользователь получает продукт высочайшего качества, а это означает, что все виды работ можно выполнять быстрее и комфортнее. Владелец торговой точки, выбравшей Proline, получает доступ к широкому спектру специальных кампаний по поддержке продаж, может принять участие во множестве вариантов обучения, а также присоединиться к уникальной программе лояльности Voyager.

\* По данным, полученным в рамках конкурса «Признание потребителей 2018».

Proline ist die bekannteste polnische Handwerkzeugmarke\*. 75% all jener, die beim Konsumentenpreis 2018 für Proline gestimmt haben, behaupten, dass sie Produkte dieser Marke ihren Freunden empfehlen würden. Dank dieser guten Bewertungen, wurden Proline-Werkzeuge 2018 zum zweiten Mal in Folge mit dem Silberkonsumentenpreis ausgezeichnet. Was Endbenutzer sagten, beweist, dass Proline-Produkte die Durchführung einer Reihe von Aufgaben erleichtern. Sie zeichnen sich durch ihre Langlebigkeit und sehr gute, professionelle Qualität aus. Es lohnt sich zu erwähnen, dass Werkzeuge der Marke polnischen Käufern 1997 zum ersten Mal bereitgestellt wurden. Die ersten Produkte waren Soft-Touch-Schraubendreher. In den nächsten zwanzig Jahren wurde Prolines Angebot erfolgreich erweitert. Heute sind es fast 5000 hochwertige Produkte, die die Bedürfnisse von Profis und all jenen, die unabhängige Reparaturen und Renovierungen vornehmen, befriedigen. Keine andere polnische Marke für Handwerkzeuge kann sich mit einem derart breiten Sortiment rühmen.

Wer sich für Proline entscheidet, erhält ein Produkt von höchster Qualität, was bedeutet, dass alle Arbeiten schneller und bequemer ausgeführt werden können. Als Besitzer eines Outlets, der Proline wählt, erhalten Sie Zugriff auf eine breite Palette, Sonderangebote und Aktionen, Teilnahme-möglichkeit an zahlreichen Schulungen sowie die Mitgliedschaft im einzigartigen Voyager-Treueprogramm.

\* Gemäß den Angaben die im Rahmen des 2018 Konsumentenpreises gesammelt wurden.





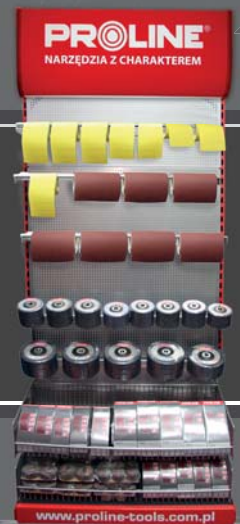
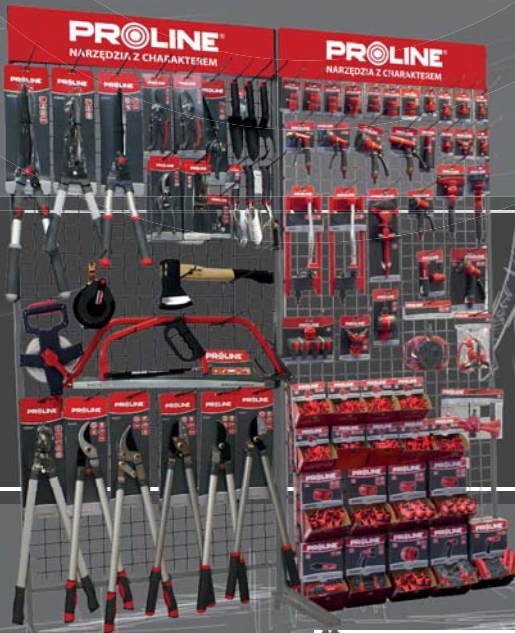



# EXPOSITION

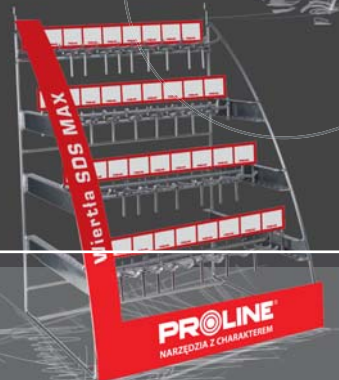

# MECHANICAL TOOLS AND WORKSHOP ACCESSORIES



- bits
- cabinets
- chargers
- cutters
- diagnostic sets
- jacks
- lamps and torches
- pliers
- pullers
- rachets
- separators
- screwdrivers
- socket wrenches
- spanners
- tool sets
- others

**1 TOOL CABINET, 7 DRAWERS WITH 250 PCS**

• ИНСТРУМЕНТАЛЬНАЯ ТЕЛЕЖКА, 7 ОТДЕЛОВ С ИНВЕНТАРЕМ 250 ШТ. • WERKZEUGSCHRANK, 7 SCHUBLADEN MIT INHALT 250 TLG.



Working top is a practical organizer with a big working space

Cabinet made of 0,8 mm steel

Drawers with bearings



Central lock

Wheel brake

Drawer lock

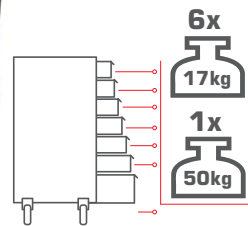

**DRAWER I**



587192

- 1/4": (18104-18113) • 1/4" L=50 mm (18121), L=100 mm (18123) • 1/4" (18160)
- 1/4" L=115 mm (18162) • (18161) • 1/4" L=145 mm (18178) • 3/8": (18306-18322) • 3/8" L=150 mm (18343), L=250 mm (18344) • 3/8" (18350) • 1/2" 3/8" (18368) • 3/8" L=200 mm (18378) • 1/2": (18508-18532) • 1/2" 16 mm (18546), 21 mm (18547) • 3/8" L=125 mm (18552), L=250 mm (18553) • 1/2" (18556) • 3/8" 1/2" (18568) • 1/2" L=250 mm (18578) • 1/2" L=250 mm (18582) • 1/2" (18610-18624) • 1/2" HEX (18644-18652) • 1/2" TORX (18657-18669)

**DRAWER II**



587194

- 6-32 mm (35606-35632) • 6x7 mm (36006), 8x9 mm (36008), 10x11 mm (36010), 12x13 mm (36012), 14x15 mm (36014), 16x17 mm (36016), 18x19 mm (36018), 20x22 mm (36020), 21x23 mm (36021), 24x27 mm (36024), 25x28 mm (36025), 30x32 mm (36030) • 9 pcs. Torx spanner set Torx T10-T50 (48339)

**DRAWER III**



587196

- Screwdrivers: Phillips nr 000 L=63 mm (10080), nr 00 L=63 mm (10081), nr 0 L=75 mm (10161), nr 1 L=100 mm (10162), nr 2 L=100 mm (10163), nr 2 L=150 mm (10164), nr 3 L=150 mm (10165), nr 4 L=200 mm (10167), nr 2 L=38 mm (10168); Flat 6x38 mm (10150), 2.5x63 mm (10151), 3.2x75 mm (10152), 5x100 mm (10153), 5x150 mm (10154), 6x150 mm (10155), 8x150 mm (10156), 3.2x100 mm (10158); Torx with opening T10x100 mm (10190), T15x100 mm (10191), T20x100 mm (10192), T25x100 mm (10193), T27x100 mm (10194), T30x100 mm (10195); T40x100 mm (10196) • Pliers: Combination 160 mm (28750); Side-cutting 160 mm (28760), End-cutting 160 mm (28765), Snipe-nose 160 mm (28770), Flat-nose 160 mm (28772)

**DRAWER IV**



587198

- Electrical probe (10544) • 1/4" L=50 mm • 1/4" 1/4" (10607), 3/8" 1/4" (10608), 1/2" 1/4" (10609) • 1/4" L=25 mm PH 0, 1, 2, 3; L=50 mm PH 1, 2, 3 • L=25 mm PZ 0, 1, 2, 3, L=50 mm PZ 1, 2, 3 • L=25 mm 4.5x0.5 mm, 5.5x0.8 mm, 6.5x1.2 mm, 8x1.6 mm • TORX L=25 mm T6, T7, T8, T9, T10, T15, T20, T25, T27, T30, T40 • L=25 mm Torx with opening T6, T7, T8, T9; T10, T15; T20, T25, T27, T30, T40 • L=25 mm HEX 3, 4, 5, 6 mm; Two-sided PH 1/2 L=50 mm; PH2/PZ2 L=50 mm; PZ 1/2 L=50 mm
- Blind rivet riveter (14007) • Curved-jaw locking pliers 180 mm (28214) • Straight-jaw locking pliers 180 mm (28240)
- Adjustable pipe pliers 250 mm (28580) • Pliers for circlips 150 mm: external-straight (28615), internal-straight (28625), external-bent (28635), internal-bent (28645) • Pocket knife (30078) • Blades (31005) • Inspection probe set (46979)
- Hex wrench set 9 pcs. 1.5-10 mm (48309)

Code	Dimensions (mm)	Amount included (pcs.)	
33130	790X490X1010	cabinet with 250 pcs. PROLINE equipment	1

The real set of the cabinet equipment may vary from the specification stated in the catalogue. The tools of similar parameters may be used as a replacement of the specified elements without prior notice.

**1 TOOL CABINET, 7 DRAWERS WITH 206 PCS**

• ИНСТРУМЕНТАЛЬНАЯ ТЕЛЕЖКА, 7 ОТДЕЛОВ С ИНВЕНТАРЕМ 206 ШТ. • WERKZEUGSCHRANK, 7 SCHUBLADEN MIT INHALT 206 TLG.



Working top is a practical organizer with a big working space

Cabinet made of 0,8 mm steel

Drawers with bearings



Central lock

Wheel brake

Drawer lock

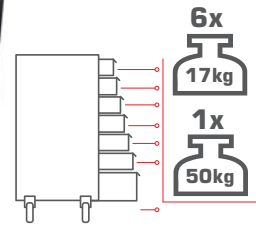

**DRAWER I**



- 58782** • 23 mm (35623), 24 mm (35624), 27 mm (35627), 30 mm (35630), 32 mm (35632)
- 58784** • 6 mm (35606), 8 mm (35608), 9 mm (35609), 10 mm (35610), 12 mm (35612), 13 mm (35613), 14 mm (35614), 15 mm (35615), 17 mm (35617), 18 mm (35618), 19 mm (35619), 22 mm (35622)
- 58724** • 1/2" L=245 mm (18578) • 1/2": 8 mm (18508), 9 mm (18509), 10 mm (18510), 11 mm (18511), 12 mm (18512), 13 mm (18513), 14 mm (18514), 15 mm (18515), 17 mm (18517), 19 mm (18519), 22 mm (18522), 24 mm (18524), 27 mm (18527), 30 mm (18530), 32 mm (18532) • 1/2" L=250 mm (18582) • 1/2" L=70 (18556) • 1/2" 16 mm (18546), 21 mm (18547)

**DRAWER II**

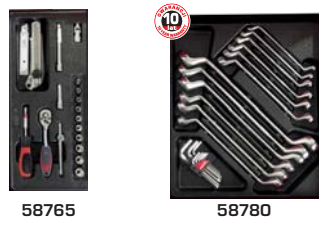

- 58765** • 1/4" 145 mm (18178) • 1/4": 4 mm (18104), 5 mm (18105), 6 mm (18106), 7 mm (18107), 8 mm (18108), 9 mm (18109), 10 mm (18110), 11 mm (18111), 12 mm (18112), 13 mm (18113) • 1/4" L=115 mm (18162) • 1/4" L=35 mm (18160) • L=50 mm (18121), L=100 mm (18123) • (18161) • Pocket knife (30078) • Blades (31005)
- 58780** • 6x7 mm (36006), 8x9 mm (36008), 10x11 mm (36010), 12x13 mm (36012), 14x15 mm (36014), 16x17 mm (36016), 18x19 mm (36018), 20x22 mm (36020), 21x23 mm (36021), 24x27 mm (36024), 25x28 mm (36025), 30x32 mm (36030) • Hex wrench set (48309)

**DRAWER III**



- 58733** • Screwdrivers: 2.5x63 mm (10151) • 3.2x100 mm (10158) • 5.0x100 mm (10153) • 6.0x150 mm (10155) • 8.0x150 mm (10156) • 3.2 X 75 mm (10152) • 6.0 x 38 mm (10150) • 5.0 x 150 mm (10154)
- 58737** • Screwdrivers: PH0x75 mm (10161), PH1x100 mm (10162), PH2x100 mm (10163), PH3x150 mm (10165), PH4x200 mm (10167), PH000x63 mm (10080), PH00x63 mm (10081), PH2x150 mm (10164)
- 58787** • TORX: T20 (18657), T25 (18658), T27 (18659), T30 (18660), T40 (18661), T45 (18662), T50 (18663), T55 (18664), T60 (18665), T70 (18669) • HEX: 4 mm (18644), 5 mm (18645), 6 mm (18646), 7 mm (18647), 8 mm (18648), 10 mm (18649), 12 mm (18650), 14 mm (18651), 17 mm (18652)

**DRAWER IV**



- 58761** • Pliers combination 160 mm (28750) • Pliers side-cutting 160 mm (28760) • Pliers snipe-nose 160 mm (28770) • Pliers end-cutting (28765) • Pliers flat-nose 160 mm (28772)
- 58763** • Pliers for circlips: • External angled 150 mm (28635) • Internal angled 150 mm (28645) • External straight 150 mm (28615) • Internal straight 150 mm (28625)
- 58795** • 1/4", 3/8", 1/2" • 25mm PH 0, 1, 2 (x2), 3 • 25mm PZ 0, 1, 2, 3 • 25mm 4.5, 5.5, 6.5, 8.0 • 25mm TORX T6, T7, T8, T9, T10, T15, T20, T25, T27, T30, T40 • 25mm TORX Security T6, T7, T8, T9, T10, T15, T20, T25, T27, T30, T40 • 25mm HEX 3, 4, 5, 6 • 50 mm PH 1, 2, 3 • 50 mm PZ 1, 2, 3 • 50 mm PH1-PH2, PH2-PZ2, PZ1-PZ2

**DRAWER V**



- 58793** • File set (32265)
- 58727** • Machinist hammer 500g (12605) • Rubber hammer 340g (12022) • Diamond needle files set: 5 pcs. (32015) • Marking tool (31382)
- 58797** • Set of punches (31361)

Code	Dimensions [mm]	Amount included [pcs.]	
33129	790x490x1010	PROLINE HD cabinet with equipment, 206 pcs.	1

The real set of the cabinet equipment may vary from the specification stated in the catalogue. The tools of similar parameters may be used as a replacement of the specified elements without prior notice.

# 1 TOOL CABINET, 7 DRAWERS WITH 206 PCS

• ИНСТРУМЕНТАЛЬНАЯ ТЕЛЕЖКА, 7 ОТДЕЛОВ С ИНВЕНТАРЕМ 206 ШТ. • WERKZEUGSCHRANK, 7 SCHUBLADEN MIT INHALT 206 TLG.

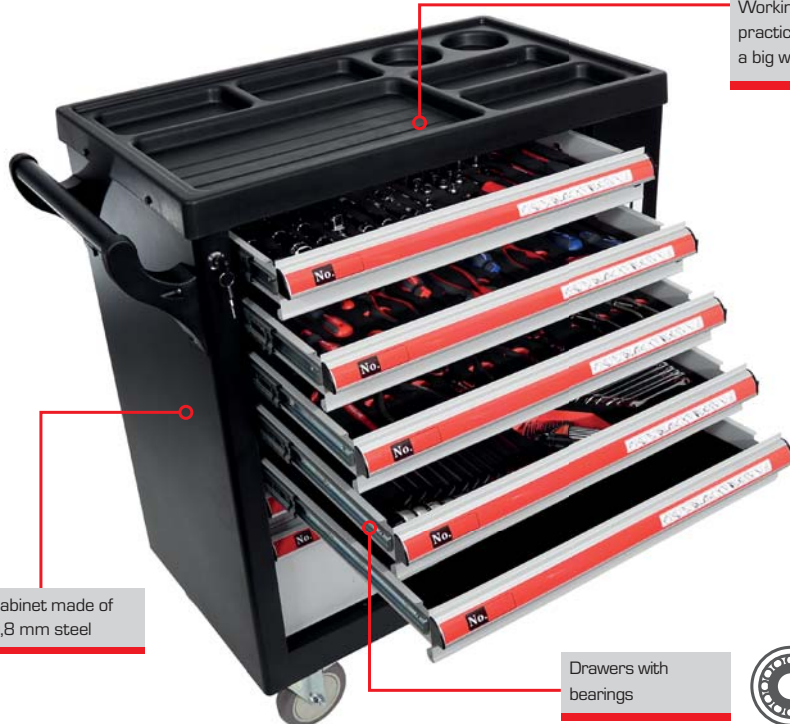

Working top is a practical organizer with a big working space

Cabinet made of 0,8 mm steel

Drawers with bearings



Central lock



Wheel brake



Drawer lock



x2

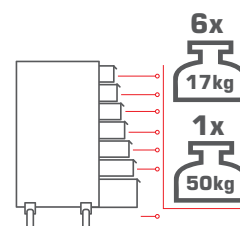

**DRAWER I**



58781



58783



58724

58781 • 23 mm (35423), 24 mm (35424), 27 mm (35427), 30 mm (35430), 32 mm (35432)

58783 • 6 mm (35406), 8 mm (35408), 9 mm (35409), 10 mm (35410), 12 mm (35412), 13 mm (35413), 14 mm (35414), 15 mm (35415), 17 mm (35417), 18 mm (35418), 19 mm (35419), 22 mm (35422)

58724 • 1/2" L=245 mm (18578) • 1/2" 8 mm (18508), 9 mm (18509), 10 mm (18510), 11 mm (18511), 12 mm (18512), 13 mm (18513), 14 mm (18514), 15 mm (18515), 17 mm (18517), 19 mm (18519), 22 mm (18522), 24 mm (18524), 27 mm (18527), 30 mm (18530), 32 mm (18532)  
• 1/2" L=250 mm (18582) • 1/2" 7 mm (18556) • 1/2" 16 mm (18546), 21 mm (18547)

**DRAWER II**



58765

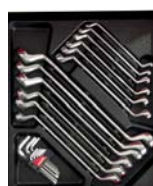

58779

58765 • 1/4" 145 mm (18178) • 1/4" 4 mm (18104), 5 mm (18105), 6 mm (18106), 7 mm (18107), 8 mm (18108), 9 mm (18109), 10 mm (18110), 11 mm (18111), 12 mm (18112), 13 mm (18113)  
• 1/4" L=115 mm (18162) • 1/4" L=35 mm (18160) • L=50 mm (18121), L=100 mm (18123) • (18161) • Pocket knife (30078) • Blades (31005)

58779 • 6x7 mm (36566), 8x9 mm (36568), 10x11 mm (36570), 12x13 mm (36572), 14x15 mm (36574), 16x17 mm (36576), 18x19 mm (36578), 20x22 mm (36580), 21x23 mm (36581), 24x27 mm (36584), 25x28 mm (36585), 30x32 mm (36590) • Hex wrench set (48309)

**DRAWER III**



58733



58737



58787

58733 • Screwdrivers: 2.5x63 mm (10151) • 3.2x100 mm (10158) • 5.0x100 mm (10153) • 6.0x150 mm (10155)  
• 8.0x150 mm (10156) • 3.2 X 75 mm (10152) • 6.0 x 38 mm (10150) • 5.0 x 150 mm (10154)

58737 • Screwdrivers: PH0x75 mm (10161), PH1x100 mm (10162), PH2x100 mm (10163), PH3x150 mm (10165), PH4x200 mm (10167), PH00x63 mm (10080), PH00x63 mm (10081), PH2x150 mm (10164)

58787 • TORX: T20 (18657), T25 (18658), T27 (18659), T30 (18660), T40 (18661), T45 (18662), T50 (18663), T55 (18664), T60 (18665), T70 (18669) • HEX: 4 mm (18644), 5 mm (18645), 6 mm (18646), 7 mm (18647), 8 mm (18648), 10 mm (18649), 12 mm (18650), 14 mm (18651), 17 mm (18652)

**DRAWER IV**



58761



58763



58795

58761 • Pliers combination 160 mm (28750) • Pliers side-cutting 160 mm (28760) • Pliers snipe-nose 160 mm (28770) • Pliers end-cutting (28765) • Pliers flat-nose 160 mm (28772)

58763 Pliers for circlips: • External angled 150 mm (28635) • Internal angled 150 mm (28645) • External straight 150 mm (28615) • Internal straight 150 mm (28625)

58795 • 1/4", 3/8", 1/2" • 25mm PH0, 1, 2 (x2), 3 • 25mm PZ0, 1, 2, 3 • 25mm 4.5, 5.5, 6.5, 8.0 • 25mm TORX T6, T7, T8, T9, T10, T15, T20, T25, T27, T30, T40 • 25mm TORX Security T6, T7, T8, T9, T10, T15, T20, T25, T27, T30, T40 • 25mm HEX 3, 4, 5, 6 • 50 mm PH 1, 2, 3 • 50 mm PZ 1, 2, 3 • 50 mm PH1-PH2, PH2-PZ2, PZ1-PZ2

**DRAWER V**



58793



58727



58797

58793 • File set (32265)

58727 • Machinist hammer 500 g (12605) • Rubber hammer 340 g (12022) • Diamond needle files set 5 pcs. (32015)  
• Marking tool (31382)

58797 • Set of punches (31361)

Code	Dimensions (mm)	Amount included (pcs.)	
33128	790X490X1010	PROLINE cabinet with equipment, 206 pcs.	1

The real set of the cabinet equipment may vary from the specification stated in the catalogue. The tools of similar parameters may be used as a replacement of the specified elements without prior notice.

PROLINE  
LAHTI PRO  
MEGA  
JUCO  
OTHER BRANDS  
ENDI  
KLINGSPOR  
EXPRESS  
ACTION CAN  
TRYTON  
VILCANN

**1 TOOL CABINET, 7 DRAWERS WITH 211 PCS**

• ИНСТРУМЕНТАЛЬНАЯ ТЕЛЕЖКА, 7 ОТДЕЛОВ С ИНВЕНТАРЕМ 211 ШТ. • WERKZEUGSCHRANK, 7 SCHUBLADEN MIT INHALT 211 TLG.



Working top is a practical organizer with a big working space



Central lock



Wheel brake



Drawer lock

Cabinet made of 0.8 mm steel

Drawers with bearings



x2

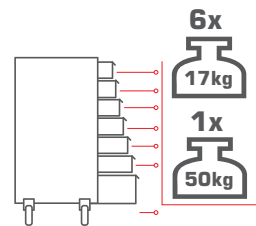

**DRAWER I**



58765



58783



58724

**58765** • 1/4" 145 mm (18178) • 1/4": 4 mm (18104), 5 mm (18105), 6 mm (18106), 7 mm (18107), 8 mm (18108), 9 mm (18109), 10 mm (18110), 11 mm (18111), 12 mm (18112), 13 mm (18113) • 1/4" L=115 mm (18162) • 1/4" L=35 mm (18160) • L=50 mm (18121), L=100 mm (18123) • (18161) • Pocket knife (30078) • Blades (31005)

**58783** • 6 mm (35406), 8 mm (35408), 9 mm (35409), 10 mm (35410), 12 mm (35412), 13 mm (35413), 14 mm (35414), 15 mm (35415), 17 mm (35417), 18 mm (35418), 19 mm (35419), 22 mm (35422)

**58724** • 1/2" L=245 mm (18578) • 1/2": 8 mm (18508), 9 mm (18509), 10 mm (18510), 11 mm (18511), 12 mm (18512), 13 mm (18513), 14 mm (18514), 15 mm (18515), 17 mm (18517), 19 mm (18519), 22 mm (18522), 24 mm (18524), 27 mm (18527), 30 mm (18530), 32 mm (18532) • 1/2" L=250 mm (18582) • 1/2" L=70 (18556) • 1/2" 16 mm (18546), 21 mm (18547)

**DRAWER II**



58733



58737



58787

**58733** • Screwdrivers: 2.5x63 mm (10151) • 3.2x100 mm (10158) • 5.0x100 mm (10153) • 6.0x150 mm (10155) • 8.0x150 mm (10156) • 3.2 X 75 mm (10152) • 6.0 x 38 mm (10150) • 5.0 x 150 mm (10154)

**58737** • Screwdrivers: PH0x75 mm (10161), PH1x100 mm (10162), PH2x100 mm (10163), PH3x150 mm (10165), PH4x200 mm (10167), PH00x63 mm (10080), PH00x63 mm (10081), PH2x150 mm (10164)

**58787** • TORX: T20 (18657), T25 (18658), T27 (18659), T30 (18660), T40 (18661), T45 (18662), T50 (18663), T55 (18664), T60 (18665), T70 (18669) • HEX: 4 mm (18644), 5 mm (18645), 6 mm (18646), 7 mm (18647), 8 mm (18648), 10 mm (18649), 12 mm (18650), 14 mm (18651), 17 mm (18652)

**DRAWER III**



58761



58763



58795

**58761** • Pliers: Combination 160 mm (28750) • Pliers side-cutting 160 mm (28760) • Pliers snipe-nose 160 mm (28770) • Pliers end-cutting (28765) • Pliers flat-nose 160 mm (28772)

**58763** Pliers for circlips: • External angled 150 mm (28635) • Internal angled 150 mm (28645) • External straight 150 mm (28615) • Internal straight 150 mm (28625)

**58795** • 1/4", 3/8", 1/2" • 25mm PH 0, 1, 2 (x2), 3 • 25mm PZ 0, 1, 2, 3 • 25mm 4.5, 5.5, 6.5, 8.0 • 25mm TORX T6, T7, T8, T9, T10, T15, T20, T25, T27, T30, T40 • 25mm TORX Security T6, T7, T8, T9, T10, T15, T20, T25, T27, T30, T40 • 25mm HEX 3, 4, 5, 6 • 50 mm PH 1, 2, 3 • 50 mm PZ 1, 2, 3

**DRAWER IV**



58793



58727



58797

**58793** • File set (32265)

**58727** • Machinist hammer: 500g (12605) • Rubber hammer 340g (12022) • Diamond needle files set: 5 pcs. (32015) • Marking tool (31382)

**58797** • Set of punches (31361)

**Additional equipment:**

**35701** • Organizer **30082** • Scissors  
**48308** • HEX wrench set: 9 pcs. **10582** • Electrical probe  
**48339** • Set of TORX wrenches: 9 pcs.

Code	Dimensions [mm]	Amount included [pcs.]	
33131	790X490X1010	PROLINE cabinet with equipment, 211 pcs.	1

The real set of the cabinet equipment may vary from the specification stated in the catalogue. The tools of similar parameters may be used as a replacement of the specified elements without prior notice.

**1 TOOL CABINET, 7 DRAWERS WITH 250 PCS**

• ИНСТРУМЕНТАЛЬНАЯ ТЕЛЕЖКА, 7 ОТДЕЛОВ С ИНВЕНТАРЕМ 250 ШТ. • WERKZEUGSCHRANK, 7 SCHUBLADEN MIT INHALT 250 TLG.



Central lock



Wheel brake



Drawer lock

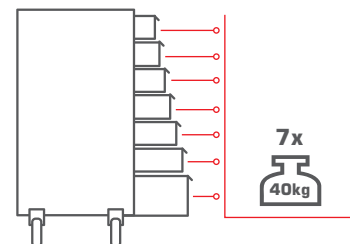

**DRAWER I**



587192

- 1/4": (18104-18113) • 1/4" L=50 mm (18121), L=100 mm (18123) • 1/4" (18160)
- 1/4" L=115 mm (18162) • (18161) • 1/4" L=145 mm (18178) • 3/8": (18306-18322) • 3/8" L=150 mm (18343), L=250 mm (18344) • 3/8" (18350) • 1/2" 3/8" (18368) • 3/8" L=200 mm (18378) • 1/2": (18508-18532) • 1/2" 16 mm (18546), 21 mm (18547) • 3/8" L=125 mm (18552), L=250 mm (18553) • 1/2" (18556) • 3/8" 1/2" (18568) • 1/2" L=250 mm (18578) • 1/2" L=250 mm (18582) • 1/2" (18610-18624) • 1/2" HEX (18644-18652) • 1/2" TORX (18657-18669)

**DRAWER II**



587194

- 6-32 mm (35606-35632) • 6x7 mm (36006), 8x9 mm (36008), 10x11 mm (36010), 12x13 mm (36012), 14x15 mm (36014), 16x17 mm (36016), 18x19 mm (36018), 20x22 mm (36020), 21x23 mm (36021), 24x27 mm (36024), 25x28 mm (36025), 30x32 mm (36030) • 9 pcs. Torx spanner set Torx T10-T50 (48339)

**DRAWER III**



587196

- Screwdrivers: Phillips nr 000 L=63 mm (10080), nr 00 L=63 mm (10081), nr 0 L=75 mm (10161), nr 1 L=100 mm (10162), nr 2 L=100 mm (10163), nr 2 L=150 mm (10164), nr 3 L=150 mm (10165), nr 4 L=200 mm (10167), nr 2 L=38 mm (10168); Flat 6x38 mm (10150), 2.5x63 mm (10151), 3.2x75 mm (10152), 5x100 mm (10153), 5x150 mm (10154), 6x150 mm (10155), 8x150 mm (10156), 3.2x100 mm (10158); Torx with opening T10x100 mm (10190), T15x100 mm (10191), T20x100 mm (10192), T25x100 mm (10193), T27x100 mm (10194), T30x100 mm (10195); T40x100 mm (10196) • Pliers: Combination 160 mm (28750); Side-cutting 160 mm (28760), End-cutting 160 mm (28765), Snipe-nose 160 mm (28770), Flat-nose 160 mm (28772)

**DRAWER IV**



587198

- Electrical probe (10544) • 1/4" L=50 mm • 1/4" 1/4" (10607), 3/8" 1/4" (10608), 1/2" 1/4" (10609) • 1/4" PH L=25 mm PH 0, 1, 2, 3; L=50 mm PH 1, 2, 3 • TORX L=25 mm T6, T7, T8, T9, T10, T15, T20, T25, T27, T30, T40 • L=25 mm Torx with opening T6, T7, T8, T9; T10, T15; T20, T25, T27, T30, T40 • L=25 mm HEX 3, 4, 5, 6 mm; Two-sided PH 1/2 L=50 mm; PH2/PZ2 L=50 mm; PZ 1/2 L=50 mm
- Blind rivet riveter (14007) • Curved-jaw locking pliers 180 mm (28214) • Straight-jaw locking pliers 180 mm (28240) • Adjustable pipe pliers 250 mm (28580) • Pliers for circlips 150 mm: external-straight (28615), internal-straight (28625), external-bent (28635), internal-bent (28645) • Pocket knife (30078) • Blades (31005) • Inspection probe set (46979)
- Hex wrench set 9 pcs. 1.5-10 mm (48309)

Code	Dimensions (mm)	Amount included (pcs.)	
33119	706 x 450 x 950	cabinet with 250 pcs. PROLINE equipment	1

The real set of the cabinet equipment may vary from the specification stated in the catalogue. The tools of similar parameters may be used as a replacement of the specified elements without prior notice.

PROLINE

LAHTI PRO

MEGA

JUCCO

OTHER BRANDS

ENDI

KLINGSPOR

EXPRESS

ACTION CAN

TRYTON

VULCAN

**1 TOOL CABINET, 7 DRAWERS WITH 206 PCS**

• ИНСТРУМЕНТАЛЬНАЯ ТЕЛЕЖКА, 7 ОТДЕЛОВ С ИНВЕНТАРЕМ 206 ШТ. • WERKZEUGSCHRANK, 7 SCHUBLADEN MIT INHALT 206 TLG.



Central lock



Wheel brake



Drawer lock

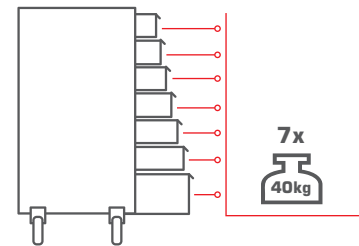

**DRAWER I**



**58782** • 23 mm (35623), 24 mm (35624), 27 mm (35627), 30 mm (35630), 32 mm (35632)

**58784** • 6 mm (35606), 8 mm (35608), 9 mm (35609), 10 mm (35610), 12 mm (35612), 13 mm (35613), 14 mm (35614), 15 mm (35615), 17 mm (35617), 18 mm (35618), 19 mm (35619), 22 mm (35622)

**58724** • 1/2" L=245 mm (18578) • 1/2": 8 mm (18508), 9 mm (18509), 10 mm (18510), 11 mm (18511), 12 mm (18512), 13 mm (18513), 14 mm (18514), 15 mm (18515), 17 mm (18517), 19 mm (18519), 22 mm (18522), 24 mm (18524), 27 mm (18527), 30 mm (18530), 32 mm (18532) • 1/2" L=250 mm (18582) • 1/2" L=70 (18556) • 1/2" 16 mm (18546), 21 mm (18547)

**DRAWER II**



**58765** • 1/4" 145 mm (18178) • 1/4": 4 mm (18104), 5 mm (18105), 6 mm (18106), 7 mm (18107), 8 mm (18108), 9 mm (18109), 10 mm (18110), 11 mm (18111), 12 mm (18112), 13 mm (18113) • 1/4" L=115 mm (18162) • 1/4" L=35 mm (18160) • L=50 mm (18121), L=100 mm (18123) • (18161) • Pocket knife (30078) • Blades (31005)

**58780** • 6x7 mm (36006), 8x9 mm (36008), 10x11 mm (36010), 12x13 mm (36012), 14x15 mm (36014), 16x17 mm (36016), 18x19 mm (36018), 20x22 mm (36020), 21x23 mm (36021), 24x27 mm (36024), 25x28 mm (36025), 30x32 mm (36030) • Hex wrench set (48309)

**DRAWER III**



**58733** • Screwdrivers: 2.5x63 mm (10151) • 3.2x100 mm (10158) • 5.0x100 mm (10153) • 6.0x150 mm (10155) • 8.0x150 mm (10156) • 3.2 X 75 mm (10152) • 6.0 x 38 mm (10150) • 5.0 x 150 mm (10154)

**58737** • Screwdrivers: PH0x75 mm (10161), PH1x100 mm (10162), PH2x100 mm (10163), PH3x150 mm (10165), PH4x200 mm (10167), PH00x63 mm (10080), PH00x63 mm (10081), PH2x150 mm (10164)

**58787** • TORX: T20 (18657), T25 (18658), T27 (18659), T30 (18660), T40 (18661), T45 (18662), T50 (18663), T55 (18664), T60 (18665), T70 (18669) • HEX: 4 mm (18644), 5 mm (18645), 6 mm (18646), 7 mm (18647), 8 mm (18648), 10 mm (18649), 12 mm (18650), 14 mm (18651), 17 mm (18652)

**DRAWER IV**



**58761** • Pliers: Combination 160 mm (28750) • Pliers side-cutting 160 mm (28760) • Pliers snipe-nose 160 mm (28770) • Pliers end-cutting (28765) • Pliers flat-nose 160 mm (28772)

**58763** Pliers for circlips: • External angled 150 mm (28635) • Internal angled 150 mm (28645) • External straight 150 mm (28615) • Internal straight 150 mm (28625)

**58795** • 1/4", 3/8", 1/2" • 25mm PH 0, 1, 2 (x2), 3 25mm PZ 0, 1, 2, 3 25mm 4.5, 5.5, 6.5, 8.0 25mm TORX T6, T7, T8, T9, T10, T15, T20, T25, T27, T30, T40 25mm TORX Security T6, T7, T8, T9, T10, T15, T20, T25, T27, T30, T40 25mm HEX 3, 4, 5, 6 50 mm PH 1, 2, 3 50 mm PZ 1, 2, 3 50 mm PH1-PH2, PH2-PZ2, PZ1-PZ2

**DRAWER V**



**58793** • File set (32265)

**58727** • Machinist hammer 500g (12605) • Rubber hammer 340g (12022) • Diamond needle files set 5 pcs. (32015) • Marking tool (31382)

**58797** • Set of punches (31361)

Code	Dimensions (mm)	Amount included (pcs.)	
33114	706 x 450 x 950	PROLINE HD cabinet with equipment, 206 pcs.	1

The real set of the cabinet equipment may vary from the specification stated in the catalogue. The tools of similar parameters may be used as a replacement of the specified elements without prior notice.



# 1 TOOL CABINET, 7 DRAWERS WITH 206 PCS

• ИНСТРУМЕНТАЛЬНАЯ ТЕЛЕЖКА, 7 ОТДЕЛОВ С ИНВЕНТАРЕМ 206 ШТ. • WERKZEUGSCHRANK, 7 SCHUBLADEN MIT INHALT 206 TLG.



**DRAWER I**



- 58781** • 23 mm (35423), 24 mm (35424), 27 mm (35427), 30 mm (35430), 32 mm (35432)
- 58783** • 6 mm (35406), 8 mm (35408), 9 mm (35409), 10 mm (35410), 12 mm (35412), 13 mm (35413), 14 mm (35414), 15 mm (35415), 17 mm (35417), 18 mm (35418), 19 mm (35419), 22 mm (35422)
- 58724** • 1/2" L=245 mm (18578) • 1/2": 8 mm (18508), 9 mm (18509), 10 mm (18510), 11 mm (18511), 12 mm (18512), 13 mm (18513), 14 mm (18514), 15 mm (18515), 17 mm (18517), 19 mm (18519), 22 mm (18522), 24 mm (18524), 27 mm (18527), 30 mm (18530), 32 mm (18532)
- 1/2" L=250 mm (18582) • 1/2" L=70 (18556) • 1/2" 16 mm (18546), 21 mm (18547)

**DRAWER II**



- 58765** • 1/4" 145 mm (18178) • 1/4": 4 mm (18104), 5 mm (18105), 6 mm (18106), 7 mm (18107), 8 mm (18108), 9 mm (18109), 10 mm (18110), 11 mm (18111), 12 mm (18112), 13 mm (18113)
- 1/4" L=115 mm (18162) • 1/4" L=35 mm (18160) • L=50 mm (18121), L=100 mm (18123) • (18161) • Pocket knife (30078) • Blades (31005)
- 58779** • 6x7 mm (36566), 8x9 mm (36568), 10x11 mm (36570), 12x13 mm (36572), 14x15 mm (36574), 16x17 mm (36576), 18x19 mm (36578), 20x22 mm (36580), 21x23 mm (36581), 24x27 mm (36584), 25x28 mm (36585), 30x32 mm (36590) • Hex wrench set (48309)

**DRAWER III**



- 58733** • Screwdrivers: 2.5x63 mm (10151) • 3.2x100 mm (10158) • 5.0x100 mm (10153) • 6.0x150 mm (10155)
- 8.0x150 mm (10156) • 3.2 X 75 mm (10152) • 6.0 x 38 mm (10150) • 5.0 x 150 mm (10154)
- 58737** • Screwdrivers: PH0x75 mm (10161), PH1x100 mm (10162), PH2x100 mm (10163), PH3x150 mm (10165), PH4x200 mm (10167), PH00x63 mm (10080), PH00x63 mm (10081), PH2x150 mm (10164)
- 58787** • TORX: T20 (18657), T25 (18658), T27 (18659), T30 (18660), T40 (18661), T45 (18662), T50 (18663), T55 (18664), T60 (18665), T70 (18669) • HEX: 4 mm (18644), 5 mm (18645), 6 mm (18646), 7 mm (18647), 8 mm (18648), 10 mm (18649), 12 mm (18650), 14 mm (18651), 17 mm (18652)

**DRAWER IV**



- 58761** • Pliers: Combination 160 mm (28750) • Pliers side-cutting 160 mm (28760) • Pliers snipe-nose 160 mm (28770) • Pliers end-cutting (28765) • Pliers flat-nose 160 mm (28772)
- 58763** Pliers for circlips: • External angled 150 mm (28635) • Internal angled 150 mm (28645) • External straight 150 mm (28615) • Internal straight 150 mm (28625)
- 58795** • 1/4", 3/8", 1/2" • 25mm PH0, 1, 2 (x2), 3 • 25mm PZ0, 1, 2, 3 • 25mm 4.5, 5.5, 6.5, 8.0 • 25mm TORX T6, T7, T8, T9, T10, T15, T20, T25, T27, T30, T40 • 25mm TORX Security T6, T7, T8, T9, T10, T15, T20, T25, T27, T30, T40 • 25mm HEX 3, 4, 5, 6 • 50 mm PH 1, 2, 3 • 50 mm PZ 1, 2, 3 • 50 mm PH1-PH2, PH2-PZ2, PZ1-PZ2

**DRAWER V**



- 58793** • File set (32265)
- 58727** • Machinist hammer 500 g (12605) • Rubber hammer 340 g (12022) • Diamond needle files set 5 pcs. (32015)
- Marking tool (31382)
- 58797** • Set of punches (31361)

Code	Dimensions (mm)	Amount included (pcs.)	
33113	706 x 450 x 950	PROLINE cabinet with equipment, 206 pcs.	1

The real set of the cabinet equipment may vary from the specification stated in the catalogue. The tools of similar parameters may be used as a replacement of the specified elements without prior notice.

**1 TOOL CABINET, 7 DRAWERS WITH 211 PCS**

• ИНСТРУМЕНТАЛЬНАЯ ТЕЛЕЖКА, 7 ОТДЕЛОВ С ИНВЕНТАРЕМ 211 ШТ. • WERKZEUGSCHRANK, 7 SCHUBLADEN MIT INHALT 211 TLG.

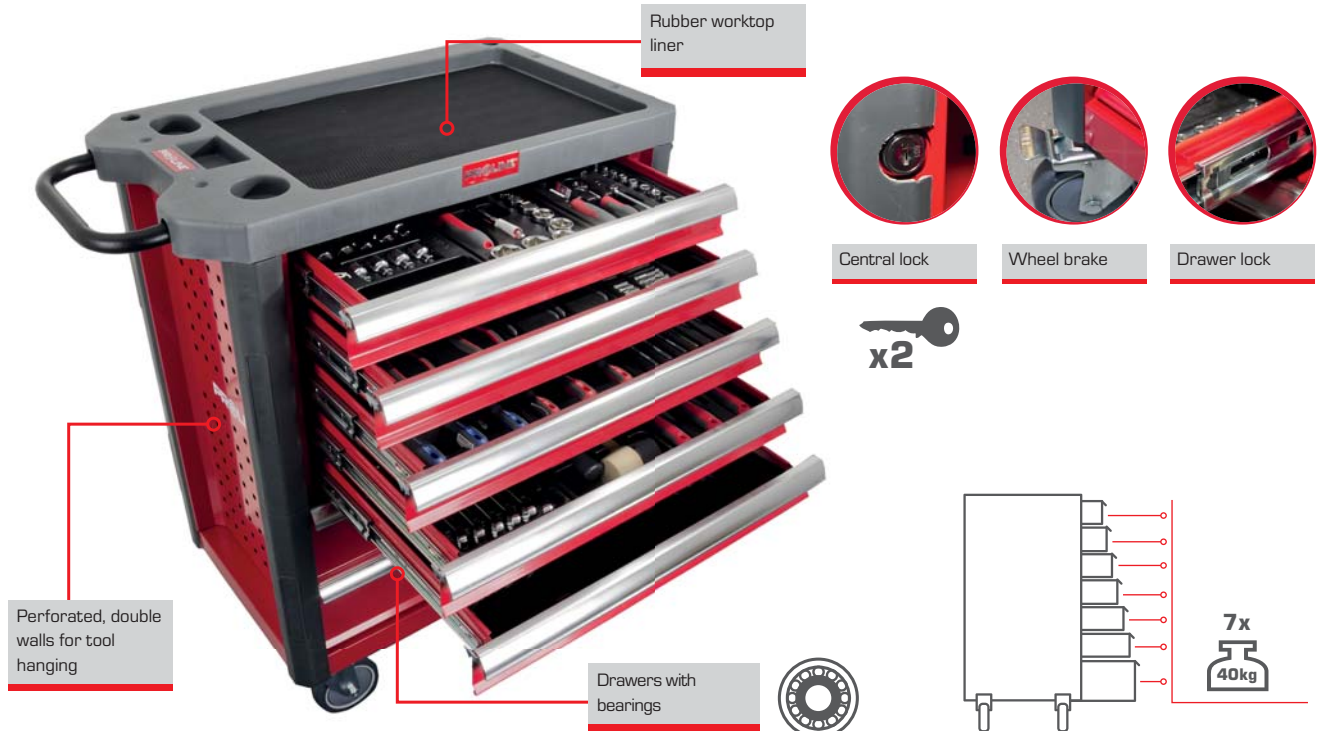

**DRAWER I**



**58765** • 1/4" 145 mm (18178) • 1/4": 4 mm (18104), 5 mm (18105), 6 mm (18106), 7 mm (18107), 8 mm (18108), 9 mm (18109), 10 mm (18110), 11 mm (18111), 12 mm (18112), 13 mm (18113) • 1/4" L=115 mm (18162) • 1/4" L=35 mm (18160) • L=50 mm (18121), L=100 mm (18123) • (18161) • Pocket knife (30078) • Blades (31005)

**58783** • 6 mm (35406), 8 mm (35408), 9 mm (35409), 10 mm (35410), 12 mm (35412), 13 mm (35413), 14 mm (35414), 15 mm (35415), 17 mm (35417), 18 mm (35418), 19 mm (35419), 22 mm (35422)

**58724** • 1/2" L=245 mm (18578) • 1/2": 8 mm (18508), 9 mm (18509), 10 mm (18510), 11 mm (18511), 12 mm (18512), 13 mm (18513), 14 mm (18514), 15 mm (18515), 17 mm (18517), 19 mm (18519), 22 mm (18522), 24 mm (18524), 27 mm (18527), 30 mm (18530), 32 mm (18532) • 1/2" L=250 mm (18582) • 1/2" L=70 (18556) • 1/2" 16 mm (18546), 21 mm (18547)

**DRAWER II**



**58733** • Screwdrivers: 2.5x63 mm (10151) • 3.2x100 mm (10158) • 5.0x100 mm (10153) • 6.0x150 mm (10155) • 8.0x150 mm (10156) • 3.2 X 75 mm (10152) • 6.0 x 38 mm (10150) • 5.0 x 150 mm (10154)

**58737** • Screwdrivers: PH0x75 mm (10161), PH1x100 mm (10162), PH2x100 mm (10163), PH3x150 mm (10165), PH4x200 mm (10167), PH00x63 mm (10080), PH00x63 mm (10081), PH2x150 mm (10164)

**58787** • TORX: T20 (18657), T25 (18658), T27 (18659), T30 (18660), T40 (18661), T45 (18662), T50 (18663), T55 (18664), T60 (18665), T70 (18669) • HEX: 4 mm (18644), 5 mm (18645), 6 mm (18646), 7 mm (18647), 8 mm (18648), 10 mm (18649), 12 mm (18650), 14 mm (18651), 17 mm (18652)

**DRAWER III**



**58761** • Pliers: Combination 160 mm (28750) • Pliers side-cutting 160 mm (28760) • Pliers snipe-nose 160 mm (28770) • Pliers end-cutting (28765) • Pliers flat-nose 160 mm (28772)

**58763** Pliers for circlips: • External angled 150 mm (28635) • Internal angled 150 mm (28645) • External straight 150 mm (28615) • Internal straight 150 mm (28625)

**58795** • 1/4", 3/8", 1/2" • 25mm PH 0, 1, 2 (x2), 3 25mm PZ 0, 1, 2, 3 25mm 4.5, 5.5, 6.5, 8.0 25mm TORX T6, T7, T8, T9, T10, T15, T20, T25, T27, T30, T40 25mm TORX Security T6, T7, T8, T9, T10, T15, T20, T25, T27, T30, T40 50 mm PH 1, 2, 3 50 mm PZ 1, 2, 3 50 mm PH1-PH2, PH2-PZ2, PZ1-PZ2

**DRAWER IV**



**58793** • File set (32265)

**58727** • Machinist hammer 500g (12605) • Rubber hammer 340g (12022) • Diamond needle files set 5 pcs. (32015) • Marking tool (31382)

**58797** • Set of punches (31361)

**Additional equipment:**

- 35701** • Organiser
- 48309** • HEX wrench set 9 pcs.
- 48339** • Set of TORX wrenches 9 pcs.
- 30082** • Scissors
- 10582** • Electrical probe

Code	Dimensions [mm]	Amount included [pcs.]	
<b>33115</b>	706 x 450 x 950	PROLINE HD cabinet with equipment, 211 pcs.	1

The real set of the cabinet equipment may vary from the specification stated in the catalogue. The tools of similar parameters may be used as a replacement of the specified elements without prior notice.

# 1 TOOL CABINETS - 5 OR 6 DRAWERS WITH TOOLS

• ИНСТРУМЕНТАЛЬНЫЕ ТЕЛЕЖКИ, 5 ИЛИ 6 ОТДЕЛОВ С ИНВЕНТАРЕМ • WERKZEUGSCHRANK, 5 ODER 6 SCHUBLADEN MIT INHALT

33117  
(6 DRAWERS)



Drawers with bearings



Wheels with bearings

33116  
(5 DRAWERS)



Central lock



Wheel brake



x2

33117

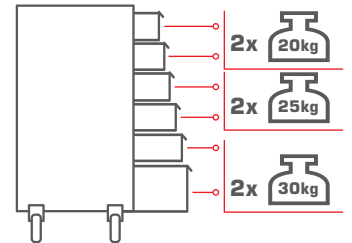

33116

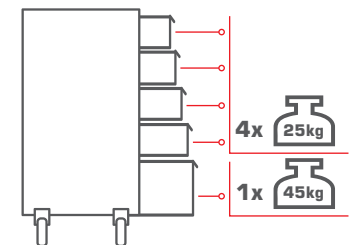

DRAWER I



58763



58765



58724

58763 • Circlip pliers: • External curved 150 mm (28635) • Internal curved 150 mm (28645) • External straight 150 mm (28615) • Internal straight 150 mm (28625)

58765 • 1/4" 145 mm (18181) • 1/4": 4 mm (18104), 5 mm (18105), 6 mm (18106), 7 mm (18107), 8 mm (18108), 9 mm (18109), 10 mm (18110), 11 mm (18111), 12 mm (18112), 13 mm (18113) • 1/4" L=115 mm (18162) • 1/4" L=35 mm (18160) • L=50 mm (18121), L=100 mm (18123) • (18168) • Knife (00078) • Blades (31005)

58724 • 1/2" L=245 mm (18281) • 1/2": 8 mm (18508), 9 mm (18509), 10 mm (18510), 11 mm (18511), 12 mm (18512), 13 mm (18513), 14 mm (18514), 15 mm (18515), 17 mm (18517), 19 mm (18519), 22 mm (18522), 24 mm (18524), 27 mm (18527), 30 mm (18530), 32 mm (18532) • 1/2" L=250 mm (18582) • 1/2" L=70 (18556) • 1/2" 16 mm (18546), 21 mm (18547)

DRAWER II



58727



58729



58731

58727 • Machinist's hammer 500g (12605) • Rubber mallet 340g (12022) • Diamond needle files, set of 5 (32015) • Marking-off scriber (31382)

58729 • Pliers: All-purpose 160mm (28700) • Diagonal side 160mm (28710) • Snipe nose 160mm (28720) • Flat nose 160mm (28722) • Automatic wire stripper (28486)

58731 • Screwdrivers: 3.2x100 mm (10158) • 5.0x100 mm (10153) • 6.0x150 mm (10155) • PH1x100 mm (10162) • PH2x100 mm (10163) • PH3x150 mm (10165) • PZ1x100 mm (10172) • PZ2x100 mm (10176)

DRAWER III



58783



58779

58783 • 6 mm (35406), 8 mm (35408), 9 mm (35409), 10 mm (35410), 12 mm (35412), 13 mm (35413), 14 mm (35414), 15 mm (35415), 17 mm (35417), 18 mm (35418), 19 mm (35419), 22 mm (35422)

58779 • 6x7 mm (36566), 8x9 mm (36568), 10x11 mm (36570), 12x13 mm (36572), 14x15 mm (36574), 16x17 mm (36576), 18x19 mm (36578), 20x22 mm (36580), 21x23 mm (36581), 24x27 mm (36584), 25x28 mm (36585), 30x32 mm (36590) • Hex spanner set (48309)

DRAWER IV



58787



58795



58797

58787 • HEX: 4 mm (18644), 5 mm (18645), 6 mm (18646), 7 mm (18647), 8 mm (18648), 10 mm (18649), 12 mm (18650), 14 mm (18651), 17 mm (18652) • TORX: T20 (18657), T25 (18658), T27 (18659), T30 (18660), T40 (18661), T45 (18662), T50 (18663), T55 (18664), T60 (18665), T70 (18666) • Flashlight (51019)

58795 • 1/4", 3/8", 1/2" • 25mm 4.5, 5.5, 6.5, 8.0 25mm PH 0, 1, 2 (x2), 3 25mm PZ 0, 1, 2, 3 25mm Torx T6, T7, T8, T9, T10, T15, T20, T25, T27, T30, T40 25mm Torx Security T6, T7, T8, T9, T10, T15, T20, T25, T27, T30, T40 25mm HEX 3, 4, 5, 6 • PH 50 mm 1, 2, 3 50 mm PZ 1, 2, 3 50 mm PH1-PH2, PH2-PZ2, PZ1-PZ2

58797 • Parallel punch set (31361)

Code	Dimensions (mm)	Number of drawers	Amount included (pcs.)	
33116	688 x 458 x 735	5	cabinet with equipment PROLINE 193 pcs.	1
33117	688 x 458 x 735	6	cabinet with equipment PROLINE 193 pcs.	1

The real set of the cabinet equipment may vary from the specification stated in the catalogue. The tools of similar parameters may be used as a replacement of the specified elements without prior notice.

# 1 TOOL CABINET - 7 DRAWERS

• ИНСТРУМЕНТАЛЬНАЯ ТЕЛЕЖКА - 7 ОТДЕЛОВ • WERKZEUGSCHRANK, 7 SCHUBLADEN

- Cabinet made of sheet steel 0.8 mm thick
- Seven versatile drawers allow the necessary tools and accessories to be stored in an orderly manner:
- Practical side storage locker with a key can hold larger accessories, tools, power tools.
- Wheels mounted on ball bearings mean moving a completely loaded cabinet trouble-free, while a steerable pair of wheels makes maneuvering easier.
- The parking brake eliminates the possibility of

- the cabinet moving without user intervention, allows it to be stably immobilised
- Ball-bearing guides used for the drawers facilitate their opening
- The central lock allows all drawers to be closed with a turn of the key
- Maximum load of drawers: 6 x 17 kg; 1 x 50 kg
- To increase comfort of use, each drawer offers protection against self-opening
- The worktop is made of high quality plastic

and has the form of a practical organiser with a large working surface. The contoured spaces for containers holding operating fluids are very practical.



Central lock



Drawer lock



Wheel brake

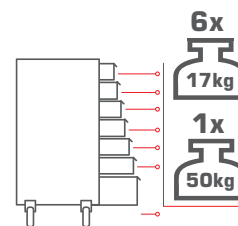

- 6 drawers with dimensions of 53 x 40 cm and a depth of 5.5 cm
- 1 drawer with dimensions of 53 x 40 cm and a depth of 20 cm
- Storage with dimensions: 12.5 x 32 and a height of 70 cm with a practical shelf mounted at half height

Code	Dimensions (mm)	Number of drawers	Icon
33127	790 x 490 x 1010	7	1

PROLINE

LAHTI PRO

MEGA

JUCO

OTHER BRANDS

ERDI

KLINGSPOR

EXPRESS

ACTION CAN

TRYTON

VULCAN

# 1 TOOL CABINET - 7 DRAWERS

• ИНСТРУМЕНТАЛЬНАЯ ТЕЛЕЖКА - 7 ОТДЕЛОВ • WERKZEUGSCHRANK - 7 SCHUBLADEN

Seven universal drawers helps to store your tools and accessories in an orderly fashion

- Wheels on ball bearings make it easy to move even fully loaded cabinet and the pair of turning wheels facilitates maneuvers
- Cabinet wheels can be locked with two brakes
- Ball slides which the drawers move on facilitate their opening

- Additionally, the central lock in a side wall enables to lock all drawers with a single key turning
- Maximum drawer load is 40 kg thanks to which you can store many tools and accessories in your cabinet
- To improve comfort of use, each drawer is protected from spontaneous opening

- Worktop is covered with a rubber lining and the tools situated on it do not displace spontaneously during transport
- The lining protects the cabinet from damage - the same is done by the corners protected with rubber TPR panels



- 5 drawers with dimensions of 53 x 40 cm and a depth of 8 cm
- 2 drawers with dimensions of 53 x 40 cm and a depth of 14 cm

Code	Dimensions (mm)	Number of drawers	
33107	706 x 450 x 950	7	1

# 1 TOOL CABINETS

• ИНСТРУМЕНТАЛЬНЫЕ ТЕЛЕЖКИ • WERKZEUGSCHRÄNKE

33106



33105



Central lock



Wheel brake



x2

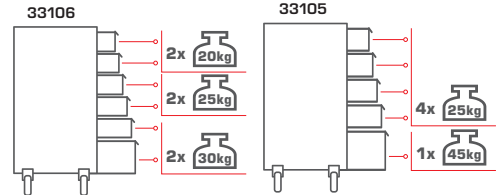

Drawers with bearings

Wheels with bearings

Drawers with bearings



- Universal drawers help to store your tools and accessories in an orderly fashion
- Wheels on ball bearings make it easy to move even fully loaded cabinet and the pair of turning wheels facilitates maneuvers
- Cabinet location can be secured with two brakes
- Ball slides which the drawers move on facilitate their opening
- Additionally, the central lock in a front wall enables to lock all drawers with a single key turning
- **33105:** 5 drawers (dimensions 58 x 41 cm; depth 1 x 20 cm, 4 x 10 cm)
- **33106:** 6 drawers (dimensions 58 x 41 cm; depth 2 x 3 cm, 2 x 8cm a 2 x 14 cm)

Code	Dimensions (mm)	Number of drawers	
33105	688 x 458 x 735	5	1
33106	688 x 458 x 735	6	1

# 2 TOOL CHEST

• ИНСТРУМЕНТАЛЬНЫЙ ЯЩИК • AUFSATZ-WERKZEUGSCHRANK



Central lock

Drawers with bearings



x2

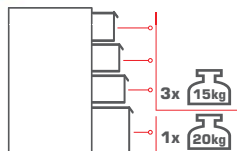

- Universal drawers help to store your tools and accessories in an orderly fashion
- Ball slides which the drawers move on facilitate their opening
- Additionally, the central lock in a front wall enables to lock all drawers with a single key turning
- 5 drawers (dimensions 58 x 28cm, depth 3 x 4 cm i 1 x 9.5 cm)

Code	Dimensions (mm)	Number of drawers	
33204	688 x 316 x 386	4	1

# 3 TOOL TROLLEY

• ТЕЛЕЖКА ДЛЯ ИНСТРУМЕНТОВ • WERKZEUGWAGEN



- Maximum capacity of 200 kg
- Material - steel, 2 mm thick (Side-cutting angle bars), 1.2 mm thick (shelves)
- 3 shelves with rubber mats
- 2 steerable wheels
- Brake
- Side handle

Code	Dimensions (mm)	
33205	730 x 380 x 755	1

**1 12 PC. TOOL TRAY FOR COMBINATION SPANNERS**

• ИНСТРУМЕНТАЛЬНЫЕ ЛОТКИ НАБОР 12 ШТ. ГАЕЧНЫХ РОЖКОВО-НАКИДНЫХ КЛЮЧЕЙ • WERKZEUGABLAGE, MAULRINGSCHLÜSSEL MIT RATSCHEN, SET 12-TLG.



**x12** 395x180 mm **DIN 3113** **CrV** 6140 **HRC** 47±2

- 6 mm (35606), 8 mm (35608), 9 mm (35609), 10 mm (35610), 12 mm (35612), 13 mm (35613), 14 mm (35614), 15 mm (35615), 17 mm (35617), 18 mm (35618), 19 mm (35619), 22 mm (35622)

Code	Items included	☐
58714	empty tray	1
58784	combination spanners 12 pcs. PROLINE HD	1

**2 12 PC. TOOL TRAY FOR COMBINATION SPANNERS**

• ИНСТРУМЕНТАЛЬНЫЕ ЛОТКИ НАБОР 12 ШТ. ГАЕЧНЫХ РОЖКОВО-НАКИДНЫХ КЛЮЧЕЙ • WERKZEUGABLAGE, MAULRINGSCHLÜSSEL MIT RATSCHEN, SET 12-TLG.



**x12** 395x180 mm **DIN 3113** **CrV**

- 6 mm (35406), 8 mm (35408), 9 mm (35409), 10 mm (35410), 12 mm (35412), 13 mm (35413), 14 mm (35414), 15 mm (35415), 17 mm (35417), 18 mm (35418), 19 mm (35419), 22 mm (35422)

Code	Items included	☐
58714	empty tray	1
58783	combination spanners 12 pcs.	1

**3 5 PC. TOOL TRAY FOR COMBINATION SPANNERS**

• ИНСТРУМЕНТАЛЬНЫЕ ЛОТКИ НАБОР 5 ШТ. ГАЕЧНЫХ РОЖКОВО-НАКИДНЫХ КЛЮЧЕЙ • WERKZEUGABLAGE, MAULRINGSCHLÜSSEL, SET 5-TLG.



**x5** 395x180 mm **DIN 3113** **CrV** 6140 **HRC** 47±2

- 23 mm (35623), 24 mm (35624), 27 mm (35627), 30 mm (35630), 32 mm (35632)

Code	Items included	☐
58713	empty tray	1
58782	combination spanners 5 pcs. PROLINE HD	1

**4 5 PC. TOOL TRAY FOR COMBINATION SPANNERS**

• ИНСТРУМЕНТАЛЬНЫЕ ЛОТКИ НАБОР 5 ШТ. ГАЕЧНЫХ РОЖКОВО-НАКИДНЫХ КЛЮЧЕЙ • WERKZEUGABLAGE, MAULRINGSCHLÜSSEL, SET 5-TLG.



**x5** 395x180 mm **DIN 3113** **CrV**

- 23 mm (35423), 24 mm (35424), 27 mm (35427), 30 mm (35430), 32 mm (35432)

Code	Items included	☐
58713	empty tray	1
58781	combination spanners 5 pcs.	1

PROLINE

LAHTI PRO

MEGA

JUCO

OTHER BRANDS

ERDI

KLINGSPOR

EXPRESS

ACTION CAN

TRYTON

VULCAN

### 1 12 PC. TOOL TRAY FOR RING SPANNERS

• ИНСТРУМЕНТАЛЬНЫЕ ЛОТКИ НАБОР 12 ШТ. ГАЕЧНЫХ НАКИДНЫХ ИЗОГНУТЫХ КЛЮЧЕЙ - WERKZEUGABLAGE, RINGSCHLÜSSEL GEKRÖPFT, SET 12-TLG.

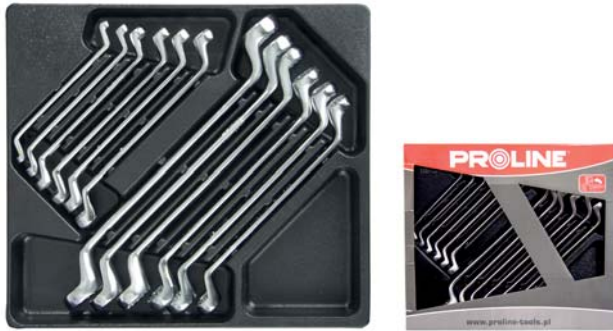

**x12** 395x360 mm **DIN 838** **CrV**

- 6x7 mm (36566), 8x9 mm (36568), 10x11 mm (36570), 12x13 mm (36572), 14x15 mm (36574), 16x17 mm (36576), 18x19 mm (36578), 20x22 mm (36580), 21x23 mm (36581), 24x27 mm (36584), 25x28 mm (36585), 30x32 mm (36590)

Code	Items included	
58711	empty tray	1
58779	ring spanners 12 pcs.	1

### 2 TOOL TRAY FOR RING SPANNERS

• ИНСТРУМЕНТАЛЬНЫЕ ЛОТКИ НАБОР 12 ШТ. ГАЕЧНЫХ НАКИДНЫХ ИЗОГНУТЫХ КЛЮЧЕЙ - WERKZEUGABLAGE, RINGSCHLÜSSEL GEKRÖPFT, SET 12-TLG.



**x12** 395x360 mm **DIN 838** **CrV** **HRC 6140** **47±2**

- 6x7 mm (36006), 8x9 mm (36008), 10x11 mm (36010), 12x13 mm (36012), 14x15 mm (36014), 16x17 mm (36016), 18x19 (36018), 20x22 mm (36020), 21x23 mm (36021), 24x27 mm (36024), 25x28 mm (36025), 30x32 mm (36030)

Code	Items included	
58711	empty tray	1
58780	ring spanners 12 pcs. PROLINE HD	1

### 3 20 PC. TOOL TRAY 20PCS. SOCKET SET WITH 1/2" DRIVE

• ИНСТРУМЕНТАЛЬНЫЕ ЛОТКИ НАБОР 20 ШТ. ТОРЦЕВЫХ ГОЛОВОК - WERKZEUGABLAGE, EINSÄTZE HEX, SET 18-TLG. 1/2"



**x20** 395x180 mm **72** **1/2"** **CrV** **PRO DRIVE**

- 1/2" L=245 mm (18578) • 1/2": 8 mm (18508), 9 mm (18509), 10 mm (18510), 11 mm (18511), 12 mm (18512), 13 mm (18513), 14 mm (18514), 15 mm (18515), 17 mm (18517), 19 mm (18519), 22 mm (18522), 24 mm (18524), 27 mm (18527), 30 mm (18530), 32 mm (18532) • 1/2" L=250 mm (18582) • 1/2": 16 mm (18546), 21 mm (18547)

Code	Items included	
58723	empty tray	1
58724	socket set 1/2" 20 pcs.	1

### 4 52 PC. TOOL TRAY SOCKET SET WITH 1/2" DRIVE

• ИНСТРУМЕНТАЛЬНЫЕ ЛОТКИ НАБОР 52 ШТ. БИТОВ - WERKZEUGABLAGE, BITS, SET 52-TLG.



**x52** 395x180 mm **50mm** **25mm** **CrV** **1/4"** **HRC 58±2**

- 1/4": 3/8", 1/2" • 25mm PH 0, 1, 2 (x2), 3 • 25mm PZ 0, 1, 2, 3 • 25mm 4.5, 5.5, 6.5, 8.0 • 25mm TORX T6, T7, T8, T9, T10, T15, T20, T25, T27, T30, T40 • 25mm TORX Security T6, T7, T8, T9, T10, T15, T20, T25, T27, T30, T40 • 25mm HEX 3, 4, 5, 6 • 50mm PH 1, 2, 3 • 50mm PZ 1, 2, 3 • 50mm PH1-PH2, PH2-PZ2, PZ1-PZ2

Code	Items included	
58795	socket set with 1/2" drive 52 pcs.	1



**1 27 PC. TOOL TRAY SOCKET SET WITH 1/4" DRIVE**

• ИНСТРУМЕНТАЛЬНЫЕ ЛОТКИ НАБОР 27 ШТ. 1/4" • WERKZEUGABLAGE, SET 16-TLG. 1/4"



**x27** 395x180 mm **72** 1/4" CrV PRO DRIVE

- 1/4" 145 mm [18178] • 1/4": 4 mm [18104], 5 mm [18105], 6 mm [18106], 7 mm [18107], 8 mm [18108], 9 mm [18109], 10 mm [18110], 11 mm [18111], 12 mm [18112], 13 mm [18113] • 1/4" L=115 mm [18162] • 1/4" L=35 mm [18160] • L=50 mm [18121], L=100 mm [18123] • [18161] • Knife [30078] • Blades [31005]

Code	Items included	
58703	empty tray	1
58765	socket set 1/4" 16 pcs.	1

**2 8 PC. TOOL TRAY FOR SCREWDRIVERS**

• ИНСТРУМЕНТАЛЬНЫЕ ЛОТКИ НАБОР ОТВЕРТОК 8 ШТ. • WERKZEUGABLAGE, SCHRAUBENDREHER, SET



**x8** 395x180 mm SOFT TOUCH Cr-V-Mo HRC 56±2

- Screwdrivers: 2.5x63 mm [10151] • 3.2x100 mm [10158] • 5.0x100 mm [10153] • 6.0x150 mm [10155] • 8.0x150 mm [10156] • 3.2 X 75 mm [10152] • 6.0 x 38 mm [10150] • 5.0 x 150 mm [10154]

Code	Items included	
58733	slot screwdrivers 8 pcs.	1

**3 19 PC. TOOL TRAY FOR SOCKET BITS**

• ИНСТРУМЕНТАЛЬНЫЕ ЛОТКИ НАБОР БИТ-ГОЛОВОК 19 ШТ. • WERKZEUGABLAGE, BITEINSÄTZE, SET 19-TLG.



**x19** 395x180 mm 1/2" CrV

- TORX: T20 [18657], T25 [18658], T27 [18659], T30 [18660], T40 [18661], T45 [18662], T50 [18663], T55 [18664], T60 [18665], T70 [18669] • HEX: 4 mm [18644], 5 mm [18645], 6 mm [18646], 7 mm [18647], 8 mm [18648], 10 mm [18649], 12 mm [18650], 14 mm [18651], 17 mm [18652]

Code	Items included	
58787	Hex and Torx socket bits 19 pcs.	1

**4 8 PC. TOOL TRAY FOR SCREWDRIVERS**

• ИНСТРУМЕНТАЛЬНЫЕ ЛОТКИ НАБОР ОТВЕРТОК ПЛОСКИХ, PHILLIPS И POZIDRIV 8 ШТ. • WERKZEUGABLAGE, SCHRAUBENDREHER, SET



**x8** 395x180 mm SOFT TOUCH Cr-V-Mo HRC 56±2

- Screwdrivers: 3.2x100 mm [10158] • 5.0x100 mm [10153] • 6.0x150 mm [10155] • PH1x100 mm [10162] • PH2x100 mm [10163] • PH3x150 mm [10165] • PZ1x100 mm [10172] • PZ2x100 mm [10176]

Code	Items included	
58730	empty tray	1
58731	slot and phillips screwdrivers 8 pcs.	1

**5 8 PC. TOOL TRAY FOR PHILLIPS SCREWDRIVERS**

• ИНСТРУМЕНТАЛЬНЫЕ ЛОТКИ НАБОР ОТВЕРТОК PHILLIPS 8 ШТ. • WERKZEUGABLAGE, SCHRAUBENDREHER KREUZ, SET

**x8** 395x180 mm SOFT TOUCH Cr-V-Mo HRC 56±2

- Screwdrivers: PH0x75 mm [10161], PH1x100 mm [10162], PH2x100 mm [10163], PH3x150 mm [10165], PH4x200 mm [10167], PH00x63 mm [10080], PH00x63 mm [10081], PH2x150 mm [10164]



Code	Items included	
58736	empty tray	1
58737	Phillips screwdrivers 8 pcs.	1

**1 5 PC. TOOL TRAY FOR PLIERS**

• ИНСТРУМЕНТАЛЬНЫЕ ЛОТКИ НАБОР КЛЕЩЕЙ 5 ШТ. • WERKZEUGABLAGE, ZANGEN, SET 5-TLG.



**x5** 395x180 mm

- Pliers: • Universal 160mm (28750) • Side-cutting 160mm (28760)
- Half-round 160 mm (28770) • End-cutting (28765) • Flat-nose 160 mm (28772)

Code	Items included	
58701	empty tray	1
58761	pliers 5 pcs.	1

**2 5 PC. TOOL TRAY FOR PLIERS**

• ИНСТРУМЕНТАЛЬНЫЕ ЛОТКИ НАБОР КЛЕЩЕЙ 5 ШТ. • WERKZEUGABLAGE, ZANGEN, SET 5-TLG.



**x5** 395x180 mm **CrV**

- Pliers: • All-purpose 160mm (28700) • Diagonal side 160mm (28710)
- Snipe nose 160mm (28720) • Flat nose 160mm (28722) • Automatic wire stripper (28486)

Code	Items included	
58728	empty tray	1
58729	pliers 1000V, 5 pcs.	1

**3 4 PC. TOOL TRAY FOR CIRCLIP PLIERS**

• ИНСТРУМЕНТАЛЬНЫЕ ЛОТКИ ДЛЯ ЩИПЦОВ ДЛЯ СТОПОРНЫХ КОЛЕЦ 4 ШТ. • WERKZEUGABLAGE FÜR SICHERUNGSRINGZANGEN



395x180 mm **CrV** **HRC 44±2** **x4**

- Circlip pliers: • External curved 150 mm (28635) • Internal curved 150 mm (28645)
- External straight 150 mm (28615) • Internal straight 150 mm (28625)

Code	Items included	
58702	empty tray	1
58763	circlip pliers 4 pcs.	1

**4 8 PC. TOOL TRAY FOR HAMMERS**

• ИНСТРУМЕНТАЛЬНЫЕ ЛОТКИ №5 ДЛЯ МОЛОТКОВ 8 ШТ. • WERKZEUGABLAGE, HÄMMER, SET 2-TLG.



**x8** 395x180 mm **12605 DIN 1041** **HRC 54±2**

- Machinist's hammer 500g (12605) • Rubber mallet 340g (12022)
- Diamond needle files, set of 5 (32015) • Marking-off scriber (31382)

Code	Items included	
58726	empty tray	1
58727	hammers 8 pcs.	1

**5 5 PC. TOOL TRAY FOR ENGINEERING FILES**

• ИНСТРУМЕНТАЛЬНЫЕ ЛОТКИ НАБОР 5 ШТ. СЛЕСАРНЫХ НАПИЛЬНИКОВ • WERKZEUGABLAGE, FEILE, SET 5-TLG.



**x5** 395x180 mm **200 mm** **HRC 62±2**

- File set (32265) • High-quality tool steel • Cut no. 2 • Two-composite, non-slip TPR handle

Code	Items included	
58718	empty tray	1
58793	engineering files 5 pcs.	1

**6 12 PC. TOOL TRAY FOR CHISELS AND PUNCHES**

• ИНСТРУМЕНТАЛЬНЫЕ ЛОТКИ НАБОР 12 ШТ. КЕРНЕРОВ,ЗУБИЛ,ПРОБОЙНИКОВ • WERKZEUGABLAGE, AUSTREIBDORNE, MEISSEL UND KÖRNER, SET 12-TLG.



**x12** 395x180 mm **CrV** **HRC 55±2**

- Set (31361)
- The set contains:
  - Center punch: 100 mm x 6 mm, 115 mm x 8 mm
  - Taper pin punch 140 mm x 2 mm
  - Chisels: 140 mm x 10 mm, 150 mm x 12 mm, 170 mm x 16 mm
  - Parallel punches: 150 mm x 8 mm, 150 mm x 6 mm, 150 mm x 5 mm, 150 mm x 4 mm, 150 mm x 3 mm, 150 mm x 1.5 mm

Code	Items included	
58722	empty tray	1
58797	chisels and punches 12 pcs.	1

**1 19 PC. SOCKET SET, 1/2" DRIVE, 8-32 MM**

• НАБОР 19 ШТ., 1/2" КВАДРАТ, 8-32 MM • 19-TLG. SET, 1/2" QUADRAT, 8-32 MM



**36** **1/2"** **CrV** **PRO DRIVE**

- 1/2" ⌀ 8, 9, 10, 11, 12, 13, 14, 15, 16, 17, 18, 19, 21, 22, 24, 27, 30, 32 mm • 1/2" 36 T • CRV material, chromium-plated and polished

Code	Amount included (pcs.)	
18719	19	10

**2 43 PC. SOCKET SET, 1/4" DRIVE, 4-14 MM**

• НАБОР 43 ШТ., 1/4" КВАДРАТ, 4-14 MM • 43-TLG. SET, 1/4" QUADRAT, 4-14 MM



**72** **1/4"** **CrV** **PRO DRIVE**

- 1/4" ⌀ 4, 4.5, 5, 5.5, 6, 7, 8, 9, 10, 11, 12, 13, 14 mm • 1/4" 72 T • 1/4" 50, 150 mm • 1/4" 1/4" • 3/8" ⌀ 1/4" • 1/4" 145 mm • 1/4" PH 1, 2, 3 PZ 1, 2, 3 ⌀ 4, 5.5, 6.5 mm TORX T8, T9, T10, T15, T20, T25, T27, T30, T40 HEX 3, 4, 5, 6, 8 mm • Made from CrV, chromium-plated and polished, delivered in a plastic case (two-material), metal hinge, metal clamps

Code	Amount included (pcs.)	
58743	43	10

**3 43 PC. SOCKET SET, 1/4" DRIVE, 4-14 MM**

• НАБОР 43 ШТ., 1/4" КВАДРАТ, 4-14 MM • 43-TLG. SET, 1/4" QUADRAT, 4-14 MM



**72** **1/4"** **CrV** **PRO DRIVE**

- 1/4" ⌀ 4, 4.5, 5, 5.5, 6, 7, 8, 9, 10, 11, 12, 13, 14 mm • 1/4" 72 T • 1/4" 50, 150 mm • 1/4" 1/4" • 3/8" ⌀ 1/4" • 1/4" 145 mm • 1/4" PH 1, 2, 3 PZ 1, 2, 3 ⌀ 4, 5.5, 6.5 mm TORX T8, T9, T10, T15, T20, T25, T27, T30, T40 HEX 3, 4, 5, 6, 8 mm • Made from CrV, satin, knurled sockets, delivered in a plastic case metal hinge, metal clamps

Code	Amount included (pcs.)	
58843	43	10



PROLINE

LAHTI PRO

MEGA

JUCCO

OTHER BRANDS

ENDI

KLINGSPOR

EXPRESS

ACTION CAN

TRYTON

VULCAN

PROLINE

LAHTI PRO

MEGA

JUCO

OTHER BRANDS

ERDI

KLINGSPOR

EXPRESS

ACTION CAN

TRYTON

VULCAN

**1 25 PC. SOCKET SET, 1/2" DRIVE, 8-32 MM**

• НАБОР 25 ШТ., 1/2" КВАДРАТ, 8-32 MM • 25-TLG. SET, 1/2" QUADRAT, 8-32 MM



72 1/2" CrV PRO DRIVE

- 1/2" 8, 9, 10, 11, 12, 13, 14, 15, 17, 18, 19, 21, 22, 24, 27, 30, 32 mm
- 1/2" 72 T • 1/2" 125, 250mm
- 1/2" 16, 21 mm • Made from CrV, chromium-plated, delivered in a plastic case (two-material), metal hinge, metal clamps

Code	Amount included (pcs.)	
58725	25	5

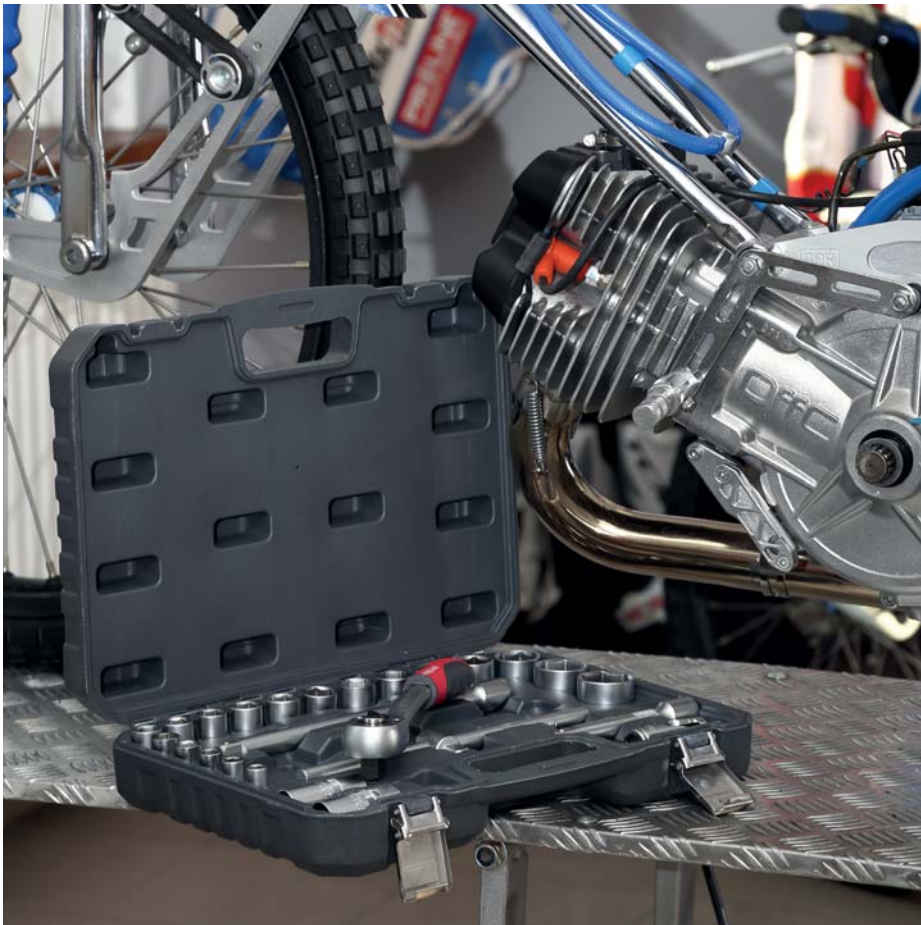

**2 25 PC. SOCKET SET, 1/2" DRIVE, 8-32 MM**

• НАБОР 25 ШТ., 1/2" КВАДРАТ, 8-32 MM • 25-TLG. SET, 1/2" QUADRAT, 8-32 MM



72 1/2" CrV PRO DRIVE

- 1/2" 8, 9, 10, 11, 12, 13, 14, 15, 17, 18, 19, 21, 22, 24, 27, 30, 32 mm • 1/2" 72 T • 1/2" 125, 250mm
- 1/2" 125, 250mm • 1/2" 16, 21 mm • Stal CrV, Satin • Knurled sockets • Delivered in a plastic case • Metal hinge, metal clamps

Code	Amount included (pcs.)	
58825	25	4

**3 56 PC. SOCKET SET, 1/2" DRIVE, 8-32 MM**

• НАБОР 56 ШТ., 1/2" КВАДРАТ, 8-32 MM • 56-TLG. SET, 1/2" QUADRAT, 8-32 MM



72 1/2" CrV PRO DRIVE

- 1/2" 8, 10, 11, 12, 13, 14, 15, 17, 18, 19, 22, 24, 27, 30, 32 mm
- 1/2" 72 T • 1/2" 16, 21 mm • 3/8" 1/2"
- 1/2" 125, 250 mm • 1/2" 10 mm • 1/2" TP T50, T55, T60 • PZ 1, 2, 3, 4 • 10 mm PH 1, 2, 3, 4 • 6.5, 8, 10, 12 mm TORX T10, T15, T20, T25, T27, T30 • TP T10, T15, T20, T25, T27, T30, T40, T45 • HEX 4, 5, 6, 8, 10 mm • Made from CrV • Satin • Knurled sockets • Delivered in a plastic case • Metal hinge, metal clamps

Code	Amount included (pcs.)	
58856	56	4

**1 94 PC. SOCKET SET, 1/4", 1/2" DRIVE, 4-32 MM**

• НАБОР 94 ШТ. 1/4", 1/2" КВАДРАТ, 4-32 ММ • 94-TLG. SET, 1/4", 1/2" QUADRAT, 4-32 MM



**72** **1/4"** **1/2"** **CrV** **PRO DRIVE**

- 1/2" 10, 11, 12, 13, 14, 15, 16, 17, 18, 19, 20, 21, 22, 23, 24, 27, 30, 32 mm • 1/2" 14, 15, 17, 19 mm • 1/2" 16, 21 mm
- 1/2" 72 T • 1/2" 125, 250 mm • 1/2" 1/2" • 1/2" 5/16" • 1/4" 4, 4.5, 5, 5.5, 6, 7, 8, 9, 10, 11, 12, 13, 14 mm • 1/4" 6, 7, 8, 9, 10, 11, 12, 13 mm • 1/4" PH1, 2, PZ1, 2, 4, 5.5, 7 mm • TORX T8, T10, T15, T20, T25, T30 • HEX 3, 4, 5, 6 mm • 5/16" PH1, 2, PZ1, 2, 8, 10, 12 mm • TORX T40, T45, T50, T55 • HEX 8, 10, 12, 14 mm • 1/4" 72 T
- 1/4" 50, 100 mm 1/4" 150 mm • 1/4" 1/4" • 1/4" 1.5, 2, 2.5 mm • Made from CrV, chromium-plated and polished, delivered in a plastic case (two-material), metal hinge, metal clamps

Code	Amount included (pcs.)	
58794	94	2

**2 94 PC. SOCKET WRENCH SET**

• НАБОР 94 ШТ. ГОЛОВОК И ПРИНАДЛАЖНОСТЕЙ • 94-TLG. STECKSCHLÜSSEL SET,



**1/4"** **1/2"** **CrV** **PRO DRIVE** **x94**

- 1/2" 10, 11, 12, 13, 14, 15, 16, 17, 18, 19, 20, 21, 22, 23, 24, 27, 30, 32 mm
- 1/2" 14, 15, 17, 19 mm • 1/2" 16, 21 mm • 1/2" 250 mm
- 1/2" 125 mm • 1/2" 250 mm • 1/2" 1/2"
- 1/2" - 5/16" 1/4" 4, 4.5, 5, 5.5, 6, 7, 8, 9, 10, 11, 12, 13, 14 • 1/4" 6, 7, 8, 9, 10, 11, 12, 13 mm • 1/4" PH 1, 2, PZ 1, 2, 4, 5.5, 7 mm • TORX T8, T10, T15, T20, T25, T30 • HEX 3, 4, 5, 6 mm • 1/4" PH 3, 4, PZ 3, 4, 8, 10, 12 mm • TORX T40, T45, T50, T55 • HEX 8, 10, 12, 14 mm • 1/4" 1/4" 125 mm • 1/4" 50, 100 mm • 1/4" 150 mm • 1/4" 1.5, 2, 2.5

Code	Amount included (pcs.)	
48794	94	3



**1 150 PC. SOCKET SET, 1/4", 3/8" AND 1/2" DRIVE, 4-32 MM**  
 • НАБОР 150 ШТ., 1/4", 3/8", 1/2" КВАДРАТ, 4-32 MM • 150-TLG. SET, 1/4", 3/8" UND 1/2" QUADRAT, 4-32 MM



72 1/4" 3/8" 1/2" CrV PRO DRIVE

- 1/4" Ⓞ 4, 4.5, 5, 5.5, 6, 7, 8, 9, 10, 11, 12, 13, 14 mm
- 1/4" Ⓞ 4, 5, 6, 7, 8, 9, 10 mm • 1/4" Ⓞ TORX E4, E5, E6, E7, E8 • 1/4" Ⓞ 72 T • 1/4" Ⓞ
- 1/4" Ⓞ • 1/4" Ⓞ 50, 100 mm • 1/4" Ⓞ
- 1/4" Ⓞ PH 0, 1, 2 Ⓞ PZ 0, 1, 2 Ⓞ 4, 5.5, 6.5, 7 mm Ⓞ TORX T8, T9, T10, T15 T20, T25, T27, T30 Ⓞ TP T8, T9, T10, T15, T20, T25, T27, T30 Ⓞ HEX 3, 4, 5, 6 mm
- 3/8" Ⓞ 10, 11, 12, 13, 14, 15, 16, 17, 18, 19 mm • 3/8" Ⓞ 10, 11, 12, 13, 14, 15 mm • 3/8" Ⓞ TORX E10, E11, E12, E14, E16, E18 • 3/8" Ⓞ 72 T • 3/8" Ⓞ
- 3/8" Ⓞ 125 mm • 3/8" Ⓞ 5/16" • 3/8" Ⓞ 18 mm • 1/2" Ⓞ 10, 11, 12, 13, 14, 15, 16, 17, 18, 19, 20, 21, 22, 24, 27, 30, 32 mm • 1/2" Ⓞ 16, 17, 18, 19, 22 mm • 1/2" Ⓞ TORX E20, E24 • 1/2" Ⓞ 72 T • 1/2" Ⓞ 125, 250 mm • 1/2" Ⓞ 1/2" Ⓞ 16, 21 mm • 3/8" Ⓞ 1/2" Ⓞ 5/16" • 1.27, 1.5, 2, 2.5, 3, 4, 5 mm
- 5/16" Ⓞ PH 3, 4 Ⓞ PZ 3, 4 Ⓞ 8, 10, 12 mm Ⓞ TORX T40, T45, T50, T55, T60, T70 Ⓞ TP T40, T45, T50, T55, T60, T70 Ⓞ HEX 7, 8, 10, 12, 14 mm • Stal CrV
- Satin • Knurled sockets • Delivered in a plastic case
- Metal hinge, metal clamps

Code	Amount included (pcs.)	
588150	150	2

**1 217 PC. SOCKET SET, 1/4", 3/8" AND 1/2" DRIVE, 3.5-32 MM WITH COMBINATION SPANNERS 8-49 MM**

• НАБОР 217 ШТ., 1/4", 3/8", 1/2" КВАДРАТ, 3,5-32 ММ С ГАЕЧНЫМИ РОЖКОВО-НАКИДНЫМИ КЛЮЧАМИ 8-19 ММ • 217-TLG. SET, 1/4", 3/8", 1/2" QUADRAT, 3,5-32 MM MIT MAULRINGSCHLÜSSELN



- 1/2" □ ○ 10, 11, 12, 13, 14, 15, 17, 19, 20, 21, 22, 24, 27, 30, 32 mm
- 1/2" □ ○ 16, 17, 18, 19, 22 mm
- 1/2" □ ○ TORX E20, E22, E24
- 1/2" □ ○ 16, 21 mm
- 1/2" □ ○ 72 T
- 1/2" □ ○ 125, 250 mm
- 1/2" □ ○
- 1/2" □ ○ T55, T60
- 1/2" □ ○ 5/16" 3/8" □ ○ 10, 11, 12, 13, 14, 15, 16, 17, 18, 19 mm
- 3/8" □ ○ 10, 11, 12, 13, 14, 15 mm
- 3/8" □ ○ TORX E10, E11, E12, E14, E16, E18 mm
- 3/8" □ ○ 18 mm
- 3/8" □ ○ 72 T
- 3/8" □ ○ 125 mm
- 3/8" □ ○
- 3/8" □ ○ 5/16"
- 1/4" □ ○ 3.5, 4, 4.5, 5, 5.5, 6, 7, 8, 9, 10, 11, 12, 13, 14 mm
- 1/4" □ ○ 4, 5, 6, 7, 8, 9, 10 mm
- 1/4" □ ○ TORX E4, E5, E6, E7, E8 mm
- 1/4" □ ○ 72 T
- 1/4" □ ○ 50, 100 mm
- 1/4" □ ○
- 1/4" □ ○
- 1/4" □ ○ 5/16"
- 1/4" □ ○
- 1/4" □ ○ 1/4"
- 1/4" □ ○

- 1/4" □ ○ PH 1, 2, 3 ○ PZ 1, 2, 3 ○ 4, 5.5, 6.5, 7 mm ○ TORX T8, T9, T10, T15, T20, T25, T27, T30 ○ T8, T9, T10, T15, T20, T25, T27, T30 ○ HEX 3, 4, 5, 6 mm
- 1/4" □ ○ PH 0, 1, 2 ○ PZ 1, 2 ○ 4, 5.5, 6.5 mm ○ TORX T8, T10, T15, T20, T25 ○ T8, T10, T15, T20, T25 ○ TS10, TS15, TS20, TS25, TS30 ○ HEX 3, 4, 5, 6 mm ○ M5, M6, M8 ○ 3, 4, 5, 6 mm ○ 1, 2 ○ 4, 6, 8 mm ○ 1, 2, 3 ○ 6, 8, 10
- 1.27, 1.5, 2, 2.5, 3, 4, 5 mm
- 8, 9, 10, 11, 12, 13, 14, 15, 16, 17, 18, 19 mm
- 5/16" □ ○ PH 3, 4 ○ PZ 3, 4 ○ 6, 7, 8 mm ○ TORX T25, T27, T30, T35, T40, T45, T50 ○ T25, T27, T30, T35, T40, T45, T50 ○ HEX 4, 5, 6, 7, 8 mm ○ M5, M6, M8, M10
- Made from CrV
- Chromium-plated and polished
- Delivered in a plastic case
- Metal clamps
- The set includes combination spanners
- Three socket sizes 1/4", 3/8" and 1/2"
- Three ratchets 1/2", 3/8", 1/4"

Code	Amount included (pcs.)				
58217	217		2		

PROLINE  
LAHTI PRO  
MEGA  
JUCO  
OTHER BRANDS  
ENDI  
KILINGSPOR  
EXPRESS  
ACTION CAN  
TRAYTON  
VALDAN

**1 17 PC. GO THRU SOCKET SET**

• НАБОР 17 ШТ. ТОРЦЕВЫХ СКВОЗНЫХ ГОЛОВОК • DURCHSTECKSCHLÜSSEL-SET 17-TLG.

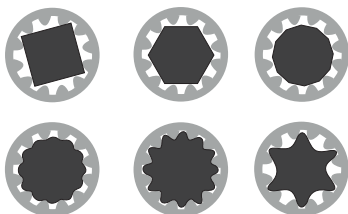

x17 CrV

- Universal shape, enabling to work with hex metric and unified-thread, TORX and SPLINE nuts and bolts
- Makes it possible to work with long bolts in places difficult to reach with standard sockets

Code	Amount included (pcs.)	
58717	17	10



**2 11 PC. TORX SOCKET SET, 1/4", 3/8", 1/2" E4-E20**

• НАБОР ТОРЦЕВЫХ ГОЛОВОК 1/2", 1/4", 3/8" С ПРОФИЛЕМ НАСАДОК TORX E4- E20, ЧИСЛО ПРЕДМЕТОВ – 11 • 11-TLG.SET, 1/4", 3/8", 1/2" QUADRAT, EINSÄTZE MIT AUSSEN-TORX E4-E20



1/4" 3/8" 1/2" CrV

- 1/2" TORX E14, E18, E20 • 3/8" TORX E7, E8, E10, E11, E12 • 1/4" TORX E4, E5, E6 • Delivered in a metal case

Code	Amount included (pcs.)	
18711	11	20

**3 12 PC. TORX SOCKET SET, 1/4", 3/8", 1/2" T8-T60**

• НАБОР 12 ШТ. ТОРЦЕВЫХ ГОЛОВОК 1/2", 1/4", 3/8" С ПРОФИЛЕМ ВСТАВОК TORX T8-T60 • 12-TLG.SET, TORX 1/4", 3/8", 1/2" QUADRAT, T8-T60



1/4" 3/8" 1/2" CrV

- 1/2" TORX T40, T45, T50, T55, T60
- 3/8" TORX T20, T25, T27, T30
- 1/4" TORX T8, T10, T15
- Delivered in a metal case

Code	Amount included (pcs.)	
18712	12	20

**4 21 PC. SOCKET SET, 3/4" DRIVE, 19-50 MM**

• НАБОР 21 ШТ. ТОРЦЕВЫХ ГОЛОВОК С 6-ГРАННЫМ ПРОФИЛЕМ 3/4", 19-50 MM • 21-TLG.SET, 3/4" QUADRAT, 19-50 MM



24 3/4" CrV PRO DRIVE

- 3/4" 19, 21, 22, 23, 24, 26, 27, 29, 30, 32, 35, 36, 38, 41, 46, 50 mm • 3/4" 24 T • 3/4" 100, 200, 400 mm • 3/4" • Delivered in a metal case

Code	Amount included (pcs.)	
18811	21	1

**5 14 PC. SOCKET SET, 3/4" DRIVE, 22-50 MM**

• НАБОР 21 ШТ. ТОРЦЕВЫХ ГОЛОВОК С 6-ГРАННЫМ ПРОФИЛЕМ 3/4", 22-50 MM • 14-TLG.SET, 3/4" QUADRAT, 22-50 MM



24 3/4" CrV PRO DRIVE

- 3/4" 22, 24, 27, 30, 32, 36, 38, 41, 46, 50 mm • 3/4" 24 T • 3/4" 100, 200 mm • 3/4" • Delivered in a metal case

Code	Amount included (pcs.)	
18804	14	1



**1 6 PT. SOCKETS**

• ТОРЦЕВЫЕ ГОЛОВКИ С 6-ГРАННЫМ ПРОФИЛЕМ • SECHSKANTAUFsätze

**PRODRIVE HEX SOCKETS PROLINE**

- Standard and extended hex sockets are offered in a wide range of sizes
- The sockets exceed strength requirements of the DIN 3124 and PN-ISO 1711 standards
- Forged chrome vanadium steel sockets, subjected to a precise hardening and tempering process that guarantees proper hardness and durability
- Chrome-plated and polished
- PROLINE sockets have specially profiled edges between the working planes - PRO-DRIVE system for mitigating excessive point loads and to protect against excessive „wearing out“ of the screw head and surfaces of the socket
- Supplied in a cardboard box or on the suspension

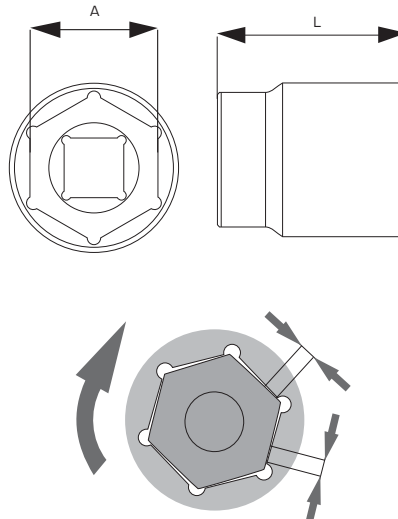

**1/4" 3/8" 1/2" 3/4" CrV PRO DRIVE**

Code	Code on the suspension	A (mm)	L (mm)	
------	------------------------	--------	--------	--

**1/2"**

18508	ZR18508	8	38	50/300
18509	ZR18509	9	38	50/300
18510	ZR18510	10	38	50/300
18511	ZR18511	11	38	50/300
18512	ZR18512	12	38	50/300
18513	ZR18513	13	38	50/300
18514	ZR18514	14	38	50/300
18515	ZR18515	15	38	50/300
18516	ZR18516	16	38	50/250
18517	ZR18517	17	38	50/250
18518	ZR18518	18	38	50/250
18519	ZR18519	19	38	50/250
18520	ZR18520	20	38	50/250
18521	ZR18521	21	38	50/200
18522	ZR18522	22	38	50/200
18523	ZR18523	23	38	50/200
18524	ZR18524	24	38	50/200
18525	ZR18525	25	42	12/144
18527	ZR18527	27	42	50/100
18528	ZR18528	28	42	50/100
18529	ZR18529	29	42	50/100
18530	ZR18530	30	42	50/100
18532	ZR18532	32	42	50/100

**3/4"**

18819	ZR18819	19	50	10/80
18821	ZR18821	21	50	10/80
18822	ZR18822	22	50	10/80
18824	ZR18824	24	51	10/80
18826	ZR18826	26	51	10/80
18827	ZR18827	27	52	10/80
18830	ZR18830	30	53	10/80
18832	ZR18832	32	54	10/80
18835	ZR18835	35	58	10/40
18836	ZR18836	36	58	10/40
18838	ZR18838	38	60	10/40
18841	ZR18841	41	64	10/20
18846	ZR18846	46	68	10/20
18850	ZR18850	50	72	10/20

Code	Code on the suspension	A (mm)	L (mm)	
------	------------------------	--------	--------	--

**1/4"**

18104	ZR18104	4	25	50/600
18104P	ZR18104P	4.5	25	50/600
18105	ZR18105	5	25	50/500
18105P	ZR18105P	5.5	25	50/500
18106	ZR18106	6	25	50/500
18107	ZR18107	7	25	50/500
18108	ZR18108	8	25	50/500
18109	ZR18109	9	25	50/500
18110	ZR18110	10	25	50/500
18111	ZR18111	11	25	50/500
18112	ZR18112	12	25	50/500
18113	ZR18113	13	25	50/500

**3/8"**

18306	ZR18306	6	28	24/288
18307	ZR18307	7	28	24/288
18308	ZR18308	8	28	24/288
18310	ZR18310	10	28	12/288
18312	ZR18312	12	28	24/288
18313	ZR18313	13	28	12/288
18314	ZR18314	14	28	18/288
18315	ZR18315	15	28	24/288
18316	ZR18316	16	28	24/288
18317	ZR18317	17	28	12/192
18319	ZR18319	19	28	24/192
18320	ZR18320	20	28	24/192
18321	ZR18321	21	28	24/192
18322	ZR18322	22	28	24/192
18324	ZR18324	24	28	24/192

**2 6 PT. DEEP SOCKETS**

• ТОРЦЕВЫЕ ГОЛОВКИ С 6-ГРАННЫМ ПРОФИЛЕМ УДЛИННЕННЫЕ • SECHSKANTAUFsätze VERLÄNGERT



**1/4" 3/8" 1/2" CrV PRO DRIVE**

- Delivered in carton box or on the suspensions

Code	Code on the suspension	A (mm)	L (mm)	
------	------------------------	--------	--------	--

**1/4"**

18163	ZR18163	4	50	50/400
18165	ZR18165	4.5	50	50/400
18166	ZR18166	5	50	50/400
18167	ZR18167	5.5	50	50/400
18169	ZR18169	6	50	50/400
18176	ZR18176	7	50	50/400
18179	ZR18179	8	50	50/500
18182	ZR18182	9	50	50/400
18183	ZR18183	10	50	50/500
18184	ZR18184	11	50	50/400
18185	ZR18185	12	50	50/200
18186	ZR18186	13	50	50/250

**3/8"**

18360	ZR18360	7	63	50/300
18361	ZR18361	8	63	50/300
18362	ZR18362	9	63	50/300
18363	ZR18363	10	63	50/300
18364	ZR18364	11	63	50/300
18365	ZR18365	12	63	50/300
18367	ZR18367	13	63	50/200
18369	ZR18369	14	63	50/150
18382	ZR18382	15	63	50/150
18383	ZR18383	16	63	50/150
18384	ZR18384	17	63	50/150
18385	ZR18385	18	63	50/150
18386	ZR18386	19	63	50/150

**1/2"**

18610	ZR18610	10	77	10/160
18611	ZR18611	11	77	10/160
18612	ZR18612	12	77	10/160
18613	ZR18613	13	77	10/160
18614	ZR18614	14	77	10/160
18615	ZR18615	15	77	10/160
18616	ZR18616	16	77	10/160
18617	ZR18617	17	77	10/160
18618	ZR18618	18	77	10/140
18619	ZR18619	19	77	10/140
18620	ZR18620	20	77	10/110
18621	ZR18621	21	77	10/110
18622	ZR18622	22	77	10/110
18624	ZR18624	24	77	10/90
18627	ZR18627	27	77	10/90
18630	ZR18630	30	77	8/64
18632	ZR18632	32	77	6/30

**1 12 PT SOCKETS, 1/2" DRIVE**

• ТОРЦЕВЫЕ ГОЛОВКИ С 12-ГРАННЫМ ПРОФИЛЕМ 1/2"  
• ZWÖLFKANTAUFSAΤZΕ, 1/2"



1/2"

CrV

Code	Code on the suspension	A (mm)	L (mm)	
18559	ZR18559	8	38	12/240
18560	ZR18560	9	38	12/240
18561	ZR18561	10	38	12/240
18562	ZR18562	11	38	12/240
18563	ZR18563	12	38	12/240
18564	ZR18564	13	38	12/240
18565	ZR18565	14	38	12/240
18566	ZR18566	15	38	12/240
18567	ZR18567	16	38	12/240
18569	ZR18569	17	38	12/240
18570	ZR18570	18	38	12/240
18571	ZR18571	19	38	12/240
18575	ZR18575	20	38	12/240
18583	ZR18583	21	38	12/144
18587	ZR18587	22	38	12/144
18588	ZR18588	23	38	12/144
18589	ZR18589	24	40	12/144
18590	ZR18590	25	42	12/144
18591	ZR18591	27	42	12/144
18592	ZR18592	28	42	12/96
18593	ZR18593	29	42	12/96
18594	ZR18594	30	45	12/96
18595	ZR18595	32	45	12/96

**2 12 PT DEEP SOCKETS, 1/2" DRIVE**

• ТОРЦЕВЫЕ УДЛИНЕННЫЕ ГОЛОВКИ С 12-ГРАННЫМ ПРОФИЛЕМ 1/2" • ZWÖLFKANTAUFSAΤZΕ, 1/2"; VERLÄNGERT



1/2"

CrV

Code	Code on the suspension	A (mm)	L (mm)	
18608	ZR18608	8	77	20/160
18609	ZR18609	9	77	20/160
18623	ZR18623	10	77	20/160
18625	ZR18625	11	77	20/160
18626	ZR18626	12	77	20/160
18628	ZR18628	13	77	15/120
18629	ZR18629	14	77	15/120
18631	ZR18631	15	77	15/120
18633	ZR18633	16	77	15/120
18634	ZR18634	17	77	15/120
18635	ZR18635	18	77	15/120
18636	ZR18636	19	77	15/120
18637	ZR18637	20	77	10/80
18638	ZR18638	21	77	10/80
18639	ZR18639	22	77	10/80
18640	ZR18640	24	77	10/80
18641	ZR18641	27	77	5/50
18642	ZR18642	30	77	5/50
18643	ZR18643	32	77	5/50

**3 SPARK PLUG SOCKETS**

• СВЕЧНЫЕ ГОЛОВКИ С 6-ГРАННЫМ ПРОФИЛЕМ • SECHSKANTE-INSÄTZE FÜR ZÜNDKERZEN



18547

18546

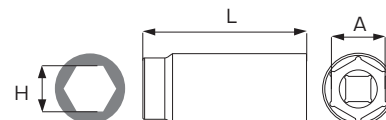

1/2" CrV PRO DRIVE

• With a rubber insert, protecting the plug from falling out and the ceramic fixture from damage • The sockets with eyelets are available for special order

Code	Code on the suspension	A (mm)	L (mm)	H (mm)	
18546	ZR18546	16	64	-	20/160
18547	ZR18547	21	64	23.6	20/100

**4 SPLINE SOCKETS, 1/2" DRIVE**

• УНИВЕРСАЛЬНЫЕ ГОЛОВКИ SPLINE 1/2" • UNIVERSALEINSÄTZE SPLINE, 1/2"

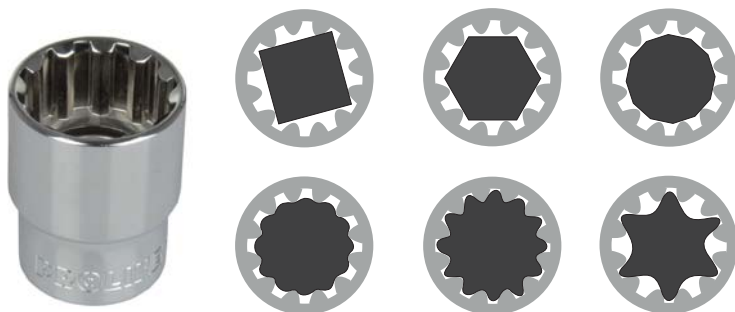

1/2"

CrV

• Universal shape enables to use for hex nuts and bolts with metric and inch sizes, square, TORX and SPLINE

Code	Code on the suspension	A (mm)	Hex bolt size (mm)	L (mm)	
18500	ZR18500	M8	8	38	10/240
18501	ZR18501	M9	9	38	10/240
18502	ZR18502	M10	10	38	10/240
18503	ZR18503	M11	11	38	10/240
18504	ZR18504	M12	12	38	50/300
18505	ZR18505	M13	13	38	50/300
18506	ZR18506	M14	14	38	10/240
18507	ZR18507	M15	15	38	10/240
18526	ZR18526	M16	16	38	10/240
18531	ZR18531	M17	17	38	10/240
18533	ZR18533	M18	18	38	50/250
18534	ZR18534	M19	19	38	10/240
18535	ZR18535	M20	20	38	10/240
18536	ZR18536	M21	21	38	10/240
18537	ZR18537	M22	22	38	10/100
18538	ZR18538	M24	24	38	10/100
18539	ZR18539	M27	27	42	10/100
18540	ZR18540	M30	30	42	10/80
18541	ZR18541	M32	32	42	10/80

**5 TORX SOCKETS BITS**

• ГОЛОВКИ TORX • TORX STECKSCHLÜSSEL BITS



1/2"

1/4"

3/8"

S2

CrV

Code	Code on the suspension	A (mm)	L (mm)	
<b>1/4"</b>				
18150	ZR18150	E4	25	50/300
18151	ZR18151	E5	25	50/300
18152	ZR18152	E6	25	50/300
18153	ZR18153	E7	25	50/300
18154	ZR18154	E8	25	50/300
18155	ZR18155	E10	25	50/300
<b>3/8"</b>				
18355	ZR18355	E10	28	50/300
18356	ZR18356	E11	28	50/300
18357	ZR18357	E12	28	50/300
18358	ZR18358	E14	28	50/300
18359	ZR18359	E16	28	50/300
<b>1/2"</b>				
18542	ZR18542	E8	38	50/300
18543	ZR18543	E10	38	50/300
18544	ZR18544	E11	38	50/300
18545	ZR18545	E12	38	50/300
18548	ZR18548	E14	38	50/250
18549	ZR18549	E16	38	50/200
18558	ZR18558	E18	38	50/250
18550	ZR18550	E20	38	50/250
18554	ZR18554	E22	38	50/200
18557	ZR18557	E24	38	20/240

**1 1/4" PHILIPS SOCKET BITS**

• БИТЫ-ГОЛОВКИ PHILIPS 1/4" • 1/4" PHILIPS STECKSCHLÜSSEL BITS



Code	Code on the suspension	A (mm)	L (mm)	
58135	ZR58135	PH1	37	50/300
58136	ZR58136	PH2	37	50/300
58137	ZR58137	PH3	37	50/300

**2 1/4" POZIDRIV SOCKET BITS**

• БИТЫ-ГОЛОВКИ POZIDRIV 1/4" • 1/4" POZIDRIV STECKSCHLÜSSEL BITS



Code	Code on the suspension	A (mm)	L (mm)	
58138	ZR58138	PZ1	37	50/300
58139	ZR58139	PZ2	37	50/300
58140	ZR58140	PZ3	37	50/300

**3 HEX SOCKET BITS**

• БИТЫ-ГОЛОВКИ HEX • INNENSECHSKANT BITS



Code	Code on the suspension	A (mm)	L (mm)	
<b>1/4"</b>				
58120	ZR58120	3	37	50/300
58121	ZR58121	4	37	50/300
58122	ZR58122	5	37	50/300
58123	ZR58123	6	37	50/500
58124	ZR58124	7	37	50/300
58125	ZR58125	8	37	50/500
<b>1/2"</b>				
58500	ZR58500	3	55	50/300
18644	ZR18644	4	55	10/120
18645	ZR18645	5	55	10/120
18646	ZR18646	6	55	50/250
18647	ZR18647	7	55	50/250
18648	ZR18648	8	55	50/250
58501	ZR58501	9	55	50/300
18649	ZR18649	10	55	50/300
18650	ZR18650	12	55	50/300
18651	ZR18651	14	55	50/200
18652	ZR18652	17	55	50/100
58502	ZR58502	19	55	50/100

**4 HEX SOCKET BITS 1/2"**

• БИТЫ-ГОЛОВКИ HEX 1/2" • INNENSECHSKANT BITS



Code	Code on the suspension	A (mm)	L (mm)	
58503	ZR58503	4	100	50/200
58504	ZR58504	5	100	50/200
58505	ZR58505	6	100	50/250
58506	ZR58506	7	100	50/150
58507	ZR58507	8	100	50/250
58508	ZR58508	10	100	50/150
58509	ZR58509	12	100	50/150
58510	ZR58510	14	100	50/100
58511	ZR58511	17	100	50/100

**5 HEX SOCKET BITS 1/2"**

• БИТЫ-ГОЛОВКИ HEX 1/2" • INNENSECHSKANT BITS



Code	Code on the suspension	A (mm)	L (mm)	
58512	ZR58512	5	140	50/150
58513	ZR58513	6	140	50/200
58514	ZR58514	7	140	50/150
58515	ZR58515	8	140	50/150
58516	ZR58516	10	140	50/150
58517	ZR58517	12	140	50/100
58518	ZR58518	14	140	50/100

**6 BALL END HEX SOCKET BITS 1/2"**

• БИТЫ-ГОЛОВКИ С ШАРИКОМ 1/2" • INNENSECHSKANT BITS 1/2" MIT KUGELKOPF



Code	Code on the suspension	A (mm)	L (mm)	
58519	ZR58519	5	140	50/100
58520	ZR58520	6	140	50/100
58521	ZR58521	7	140	50/100
58522	ZR58522	8	140	50/100
58523	ZR58523	10	140	50/100

**7 TORX SOCKET BITS**

• БИТЫ-ГОЛОВКИ TORX • TORX STECKSCHLÜSSEL BITS



Code	Code on the suspension	A (mm)	L (mm)	
<b>1/4"</b>				
58126	ZR58126	T8	37	50/500
58127	ZR58127	T9	37	50/300
58128	ZR58128	T10	37	50/300
58129	ZR58129	T15	37	50/300
58130	ZR58130	T20	37	50/300
58131	ZR58131	T25	37	50/300
58132	ZR58132	T27	37	50/300
58133	ZR58133	T30	37	50/300
58134	ZR58134	T40	37	50/300
<b>3/8"</b>				
58300	ZR58300	T8	48	50/300
58301	ZR58301	T9	48	50/300
58302	ZR58302	T10	48	50/300
58303	ZR58303	T15	48	50/300
58304	ZR58304	T20	48	50/300
58305	ZR58305	T25	48	50/300
58306	ZR58306	T27	48	50/300
58307	ZR58307	T30	48	50/500
58308	ZR58308	T40	48	50/300
58309	ZR58309	T50	48	50/500
58310	ZR58310	T55	48	50/300
<b>1/2"</b>				
18657	ZR18657	T20	55	10/120
18658	ZR18658	T25	55	10/120
18659	ZR18659	T27	55	10/120
18660	ZR18660	T30	55	50/250
18661	ZR18661	T40	55	50/200
18662	ZR18662	T45	55	50/200
18663	ZR18663	T50	55	50/200
18664	ZR18664	T55	55	50/200
18665	ZR18665	T60	55	50/200
18669	ZR18669	T70	55	10/120

**8 TORX SOCKET BITS 1/2"**

• БИТЫ-ГОЛОВКИ TORX 1/2" • TORX STECKSCHLÜSSEL BITS



Code	Code on the suspension	A (mm)	L (mm)	
58533	ZR58533	T20	100	50/200
58534	ZR58534	T25	100	50/200
58535	ZR58535	T27	100	50/150
58536	ZR58536	T30	100	50/250
58537	ZR58537	T40	100	50/150
58538	ZR58538	T45	100	50/150
58539	ZR58539	T50	100	50/250
58540	ZR58540	T55	100	50/150
58541	ZR58541	T60	100	50/150
58542	ZR58542	T70	100	50/100

PROLINE

LAHTI PRO

MEGA

JUCO

OTHER BRANDS

ERDI

KLINGSPOR

EXPRESS

ACTION CAN

TRAYTON

VULCAN

**1 TORX SOCKET BITS 1/2"**

• БИТЫ-ГОЛОВКИ TORX 1/2" • TORX STECKSCHLÜSSEL BITS



★  
1/2"  
S2  
CrV

Code	Code on the suspension	A (mm)	L (mm)	☐
58547	ZR58547	T40	120	50/150
58548	ZR58548	T50	120	50/150
58543	ZR58543	T50	140	50/150
58544	ZR58544	T55	140	50/150
58545	ZR58545	T60	140	50/100
58546	ZR58546	T70	140	50/100

**4 SPLINE SOCKET BITS 1/2"**

• БИТЫ-ГОЛОВКИ SPLINE 1/2" • SPLINE STECKSCHLÜSSEL BITS 1/2"



★  
1/2"  
S2  
CrV

Code	Code on the suspension	A (mm)	L (mm)	☐
18666	ZR18666	M5	55	10/120
18653	ZR18653	M6	55	10/120
18654	ZR18654	M8	55	10/120
18655	ZR18655	M10	55	10/120
18656	ZR18656	M12	55	10/120
18667	ZR18667	M14	55	10/120
18668	ZR18668	M16	55	10/120

**2 RIBE SOCKET BITS 1/2"**

• БИТЫ-ГОЛОВКИ RIBE 1/2" • RIBE STECKSCHLÜSSEL BITS 1/2"



★  
1/2"  
S2  
CrV

Code	Code on the suspension	A (mm)	L (mm)	☐
58524	ZR58524	R7	55	50/300
58525	ZR58525	R9	55	50/300
58526	ZR58526	R10	55	50/300
58527	ZR58527	R12	55	50/200
58528	ZR58528	R14	55	50/150
58529	ZR58529	R16	55	50/150

**5 SPLINE SOCKET BITS 1/2"**

• БИТЫ-ГОЛОВКИ SPLINE 1/2" • SPLINE STECKSCHLÜSSEL BITS 1/2"



★  
1/2"  
S2  
CrV

Code	Code on the suspension	A (mm)	L (mm)	☐
58549	ZR58549	M6	100	50/150
58550	ZR58550	M8	100	50/250
58551	ZR58551	M10	100	50/150
58552	ZR58552	M12	100	50/150
58553	ZR58553	M14	100	50/150
58554	ZR58554	M16	100	50/100

**3 RIBE SOCKET BITS 1/2"**

• БИТЫ-ГОЛОВКИ RIBE 1/2" • RIBE STECKSCHLÜSSEL BITS 1/2"



★  
1/2"  
S2  
CrV

Code	Code on the suspension	A (mm)	L (mm)	☐
58530	ZR58530	R12	100	50/300
58531	ZR58531	R14	100	50/100
58532	ZR58532	R16	100	50/100

**6 SOCKET AND SOCKET BIT RAILS 1/4", 3/8", 1/2"**

• ПЛАНКИ ДЛЯ ГОЛОВКИ И БИТ-ГОЛОВКИ 1/4", 3/8" И 1/2" • STECKSCHLÜSSEL UND BITSCHIENEN 1/4", 3/8", 1/2"



Code	Type	L (mm)	Amount (pcs)	☐	☐
18199	1/4", 6 clips	120	2	x	200
18399	3/8", 6 clips	280	2	x	200
18599	1/2", 6 clips	280	2	x	200



**1 REVERSIBLE RATCHETS**

• КЛЮЧИ ТРЕЩОТЧНЫЕ • GRIFFE MIT RATSCHÉ

108-tooth gear  
(3.33° stroke)

Slim head



Reduced dimensions facilitating work in hard-to-reach places

All metal with non-slip insert

108 1/4" 3/8" 1/2" CrV

• Push button • Handle with plastic insert • Pitch 3.33° • Reduced head dimensions

Code	Square	L (mm)		
18191	1/4"	133	x	25/100
18391	3/8"	192	x	12/48
18691	1/2"	260	x	6/24

**2 REVERSIBLE RATCHETS**

• КЛЮЧИ ТРЕЩОТЧНЫЕ • GRIFFE MIT RATSCHÉ



72 1/4" 3/8" 1/2" CrV

• Push button • Swan-neck ratchet with a socket made from two-component material, with rubber components cast-in

Code	Code on the suspension	Square	L (mm)	
18172	ZR18172	1/4"	145	25/100
18372	ZR18372	3/8"	200	12/48
18572	ZR18572	1/2"	250	6/24

**3 REVERSIBLE RATCHETS**

• КЛЮЧИ ТРЕЩОТЧНЫЕ • GRIFFE MIT RATSCHÉ



72 1/4" 3/8" 1/2" CrV TPR/PP

• Push button

Code	Square	L (mm)		
18194	1/4"	157	x	12/96
18394	3/8"	201	x	12/48
18694	1/2"	258	x	6/24

**4 COMPOSITE REVERSIBLE RATCHETS**

• РУКОЯТКИ КОМПОЗИТНЫЕ С ТРЕЩОТКОЙ • ZUSAMMENSETzte UMSCHALTKNARREN



72 1/4" 3/8" 1/2" CrV TPR/PP

• Push button • Two-component handle TPR/PP

Code	Square	L (mm)		
18195	1/4"	144	x	25/100
18295	3/8"	202	x	12/48
18695	1/2"	257	x	6/24

**5 REVERSIBLE RATCHETS WITH FLEXIBLE HEAD**

• КЛЮЧИ ТРЕЩОТЧНЫЕ С ШАРНИРОМ • GRIFFE MIT RATSCHÉ UND BEWEGLICHEM KORP



36 1/4" 3/8" 1/2" CrV TPR/PP

• Ring switch • Moving head

Code	Square	L (mm)		
18192	1/4"	178	x	12/96
18392	3/8"	257	x	12/48
18692	1/2"	305	x	6/24

**6 EXTENDABLE REVERSIBLE RATCHETS WITH FLEXIBLE HEAD**

• РУКОЯТКИ С ТРЕЩОТКОЙ ТЕЛЕСКОПИЧЕСКИЕ С ШАРНИРОМ • AUSZIEHBARE UMSCHALTKNARREN MIT FLEXIBLEM KORP



36 1/4" 3/8" 1/2" CrV TPR/PP

• Ring switch • Moving head

Code	Square	L (mm)		
18193	1/4"	197-245	x	12/72
18393	3/8"	273-375	x	6/36
18693	1/2"	368-508	x	5/20

PROLINE

LANITI PRO

MEGA

JUCO

OTHER BRANDS

ERDI

KUNGSFOR

EXPRESS

ACTION CAN

TRYTON

VULCAN

**1 REVERSIBLE RATCHETS**

• КЛЮЧИ ТРЕЩОТЧНЫЕ • GRIFFE MIT RATSCHEN



72 1/4" 3/8" 1/2" CrV

• Push button • Two-component material handle

Code	Code on the suspension	Square	L (mm)	
18178	ZR18178	1/4"	145	50/150
18378	ZR18378	3/8"	200	30/60
18578	ZR18578	1/2"	250	15/30

**2 REVERSIBLE RATCHETS WITH FLEXIBLE HEAD**

• КЛЮЧИ ТРЕЩОТЧНЫЕ С ШАРНИРОМ • GRIFFE MIT RATSCHEN UND BEWEGLICHEM KOPF

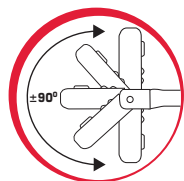

72 1/4" 3/8" 1/2" CrV

• Push button • Ratchet with a socket made from two-component material, with rubber components cast-in • Moveable head

Code	Code on the suspension	Square	L (mm)	
18180	ZR18180	1/4"	164	25/100
18580	ZR18580	1/2"	285	6/24

**3 REVERSIBLE RATCHETS**

• КЛЮЧИ ТРЕЩОТЧНЫЕ • GRIFFE MIT RATSCHEN



24 1/4" 3/8" 1/2" CrV

• Push button • Two-component material handle

Code	Square	L (mm)		
18196	1/4"	145	x	50/150
18396	3/8"	200	x	30/60
18696	1/2"	250	x	15/30

**4 STUBBY DOUBLE SIDED RATCHET**

• КЛЮЧ ТРЕЩОТЧНЫЙ КОРОТКИЙ, ДВУХСТОРОННИЙ • KURZER GRIFF MIT RATSCHEN



72 3/8" 1/2" CrV

• Push button • Two-component material handle

Code	Square	L (mm)	
18579	1/2" x 3/8"	135	20/80

**5 REVERSIBLE RATCHETS**

• КЛЮЧИ ТРЕЩОТЧНЫЕ • GRIFFE MIT RATSCHEN



24 1/4" 3/8" 1/2" CrV

• Rotary switch • Polished

Code	Code on the suspension	Square	L (mm)	
18175	ZR18175	1/4"	145	25/100
18375	ZR18375	3/8"	200	15/60
18576	ZR18576	1/2"	250	15/30

**6 REVERSIBLE RATCHET**

• КЛЮЧ ТРЕЩОТЧНЫЙ • GRIFFE MIT RATSCHEN



24 3/4" CrV

• Push button • Knurled handle

Code	Code on the suspension	Square	L (mm)	
18860	ZR18860	3/4"	510	5/10

**7 OFF-SET HANDLES**

• ВОРОТКИ • VERSETZTE GRIFFE



1/2" 3/4" CrV

• Knurled handle

Code	Code on the suspension	Square	L (mm)	
18581	ZR18581	1/2"	200	15/60
18865	ZR18865	3/4"	450	10

**8 FLEXIBLE HANDLES**

• ВОРОТКИ ШАРНИРНЫЕ • GELENKGRIFFE



1/4" 3/8" 1/2" 3/4" CrV

• Knurled handle

Code	Code on the suspension	Square	L (mm)	
18164	ZR18164	1/4"	150	36/144
18354	ZR18354	3/8"	200	24/96
18584	ZR18584	1/2"	250	15/60
18585	ZR18585	1/2"	375	20
18586	ZR18586	1/2"	450	20
18864	ZR18864	3/4"	510	10

**1 SLIDING T-BARS**

• ВОРОТКИ Т-ОБРАЗНЫЕ • T-GRIFFE VERSCHIEBBAR



• Knurled handle

1/4" 3/8" 1/2" 3/4" CrV

Code	Code on the suspension	Square	L (mm)	
18162	ZR18162	1/4"	115	24/384
18352	ZR18352	3/8"	165	12/144
18582	ZR18582	1/2"	250	15/60
18863	ZR18863	3/4"	460	10

**2 SPINNER HANDLE 1/4"**

• РУКОЯТКА ДЛЯ ГОЛОВОК 1/4" • STECKGRIFF 1/4"



• Two-component handle

1/4" CrV

Code	Square	L (mm)		
18161	1/4"	150	x	30/60

**3 SPINNER HANDLE 1/4"**

• РУКОЯТКА ДЛЯ ГОЛОВОК 1/4" • STECKGRIFF 1/4"



• Two-component handle

1/4" CrV

Code	Square	L (mm)		
18171	1/4"	150	x	30/60

**4 UNIVERSAL JOINTS**

• ШАРНИРЫ КАРДАННЫЕ  
• KARDANGELENKE UNIVERSAL



1/4" 3/8" 1/2" 3/4" CrV

• Enables to apply torque from 0° to 75°

Code	Code on the suspension	Square	L (mm)	
18160	ZR18160	1/4"	35	48/384
18350	ZR18350	3/8"	50	24/288
18556	ZR18556	1/2"	70	12/144
18858	ZR18858	3/4"	100	10/20

**5 ADAPTORS**

• АДАПТЕРЫ-ПЕРЕХОДНИКИ • VERBINDUNGSTÜCKE (REDUKTIONEN)

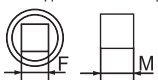

3/8" 1/2" 3/4" CrV

• Enables cooperation of ratchets, sockets and other accessories with different dimensions of the socket and pivot

Code	Code on the suspension	Socket (F)	Foot (M)	
18368	ZR18368	1/2"	3/8"	25/300
18568	ZR18568	3/8"	1/2"	25/300
18867	ZR18867	3/4"	1/2"	12/96
18868	ZR18868	1/2"	3/4"	25/150

**6 EXTENSION BARS**

• УДЛИНИТЕЛИ • VERLÄNGERUNGEN



1/4" 3/8" 1/2" 3/4" CrV

• Enables work in places difficult to reach • With a locking ball securing the attachment during use • Extensions have a square socket on one end and a rounded square pin on the other end to help work at angles

Code	Code on the suspension	Square	L (mm)	
18121	ZR18121	1/4"	50	48/576
18122	ZR18122	1/4"	75	32/576
18123	ZR18123	1/4"	100	24/384
18124	ZR18124	1/4"	150	24/288
18341	ZR18341	3/8"	75	24/288
18342	ZR18342	3/8"	125	24/144
18343	ZR18343	3/8"	150	12/144
18344	ZR18344	3/8"	250	50/100
18551	ZR18551	1/2"	75	50/150
18552	ZR18552	1/2"	125	50/100
18553	ZR18553	1/2"	250	50
18871	ZR18871	3/4"	100	50
18872	ZR18872	3/4"	200	25
18874	ZR18874	3/4"	400	10

**7 WOBBLE EXTENSION BARS**

• УДЛИНИТЕЛИ ОТКЛОНЯЕМЫЕ • ZAPFEN-VERLÄNGERUNGSSTANGEN



1/4" 3/8" 1/2" CrV

• Enables work in places difficult to reach • With a locking ball securing the attachment during use • Extensions have a square socket on one end and a rounded square pin on the other end to help work at angles

Code	Code on the suspension	Square	L (mm)	
18126	ZR18126	1/4"	50	50/300
18127	ZR18127	1/4"	100	50/300
18128	ZR18128	1/4"	150	50/150
18129	ZR18129	1/4"	250	50/150
18346	ZR18346	3/8"	50	50/300
18347	ZR18347	3/8"	100	50/150
18348	ZR18348	3/8"	150	50/150
18349	ZR18349	3/8"	250	50/100
18671	ZR18671	1/2"	75	50/150
18672	ZR18672	1/2"	125	50/100
18673	ZR18673	1/2"	200	50
18674	ZR18674	1/2"	250	50

**8 FLEXIBLE EXTENSION BARS**

• УДЛИНИТЕЛИ ГИБКИЕ • VERLÄNGERUNGEN ELASTISCH

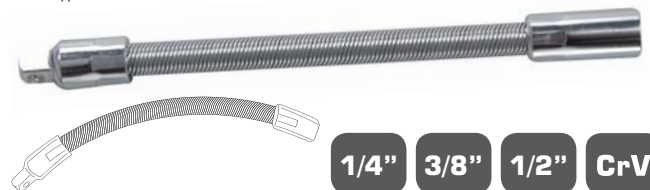

1/4" 3/8" 1/2" CrV

Code	Code on the suspension	Square	L (mm)	
18125	ZR18125	1/4"	145	12/300
18345	ZR18345	3/8"	200	10/150
18555	ZR18555	1/2"	200	10/60

**1 6 PT. IMPACT SOCKETS**

• УДАРНЫЕ ТОРЦЕВЫЕ ГОЛОВКИ С 6-ГРАННЫМ ПРОФИЛЕМ • SCHLAG-SECHSKANTAUFsätze



**1/2" 3/4" CrMo SCM-440 PRO DRIVE**

- Standard-length and elongated PROLINE hex impact sockets are offered in a wide selection of sizes • Cooperate with pneumatic devices, dedicated to difficult working conditions and changeable loads • Made from strong CrMo steel thanks to which they have longer working lifecycle, twice higher tensile strength and three times higher yield point than the ordinary sockets from chromium and vanadium tool steel • PROLINE sockets have special, profiled, rounded open angles between the work planes - PRO-DRIVE system - to level spot overloads, accumulating in the internal edges of the socket. PRO-DRIVE system ensures increased torque without the socket wall break, improved socket lifecycle and protects the edges of the bolt head
- Square sockets are compatible with most locking mechanisms in renowned pneumatic devices • Delivered in a cardboard box or on a suspension

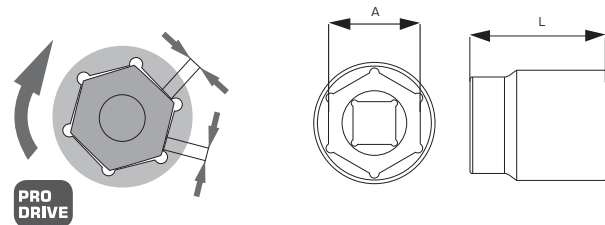

**2 6 PT. DEEP IMPACT SOCKETS**

• УДАРНЫЕ ТОРЦЕВЫЕ ГОЛОВКИ УДЛИНЕННЫЕ С 6-ГРАННЫМ ПРОФИЛЕМ • SCHLAG-SECHSKANTAUFsätze VERLÄNGERT



**1/2" 3/4" CrMo SCM-440 PRO DRIVE**

- Delivered in a cardboard box or on a suspension

**1/2"**

Code	Code on the suspension	A (mm)	L (mm)	
18410	ZR18410	10	39	60/240
18411	ZR18411	11	39	60/240
18412	ZR18412	12	39	60/240
18413	ZR18413	13	39	60/240
18414	ZR18414	14	39	60/240
18415	ZR18415	15	39	40/160
18416	ZR18416	16	39	40/160
18417	ZR18417	17	39	40/160
18418	ZR18418	18	39	40/160
18419	ZR18419	19	39	40/160
18420	ZR18420	20	39	40/160
18421	ZR18421	21	39	40/160
18422	ZR18422	22	39	30/120
18423	ZR18423	23	39	30/120
18424	ZR18424	24	43	30/120
18425	ZR18425	25	43	30/120
18426	ZR18426	26	43	24/96
18427	ZR18427	27	43	24/96
18428	ZR18428	28	48	24/96
18429	ZR18429	29	48	22/88
18430	ZR18430	30	48	24/96
18432	ZR18432	32	48	20/80

**3/4"**

18919	ZR18919	19	50	16/64
18921	ZR18921	21	50	16/64
18922	ZR18922	22	50	16/64
18923	ZR18923	23	50	16/64
18924	ZR18924	24	50	16/64
18925	ZR18925	25	50	16/64
18926	ZR18926	26	50	16/64
18927	ZR18927	27	53	16/64
18928	ZR18928	28	53	16/64
18929	ZR18929	29	53	12/48
18930	ZR18930	30	53	12/48
18932	ZR18932	32	56	12/48
18933	ZR18933	33	56	8/32
18934	ZR18934	34	56	8/32
18935	ZR18935	35	56	6/24
18936	ZR18936	36	56	6/24
18938	ZR18938	38	57	6/24
18941	ZR18941	41	57	5/20
18942	ZR18942	42	57	4/16
18943	ZR18943	43	57	4/16
18946	ZR18946	46	62	3/12
18948	ZR18948	48	67	3/12
18950	ZR18950	50	72	3/12
18952	ZR18952	52	72	2/8
18955	ZR18955	55	74	2/4
18960	ZR18960	60	74	2/4

**1/2"**

Code	Code on the suspension	A (mm)	L (mm)	
18440	ZR18440	10	78	30/120
18441	ZR18441	11	78	30/120
18442	ZR18442	12	78	30/120
18443	ZR18443	13	78	30/120
18444	ZR18444	14	78	30/120
18445	ZR18445	15	78	30/120
18446	ZR18446	16	78	30/120
18447	ZR18447	17	78	25/100
18448	ZR18448	18	78	24/96
18449	ZR18449	19	78	24/96
18450	ZR18450	20	78	20/80
18451	ZR18451	21	78	20/80
18452	ZR18452	22	78	18/72
18453	ZR18453	23	78	15/60
18454	ZR18454	24	78	15/60
18455	ZR18455	25	78	15/60
18456	ZR18456	26	78	12/48
18457	ZR18457	27	78	12/48
18458	ZR18458	28	78	12/48
18459	ZR18459	29	78	10/40
18460	ZR18460	30	78	10/40
18462	ZR18462	32	78	10/40

**3/4"**

18969	ZR18969	19	90	9/36
18971	ZR18971	21	90	9/36
18972	ZR18972	22	90	9/36
18973	ZR18973	23	90	9/36
18974	ZR18974	24	90	9/36
18975	ZR18975	25	90	9/36
18976	ZR18976	26	90	9/36
18977	ZR18977	27	90	9/36
18978	ZR18978	28	90	8/32
18979	ZR18979	29	90	8/32
18980	ZR18980	30	90	7/28
18982	ZR18982	32	90	7/28
18983	ZR18983	33	90	6/24
18984	ZR18984	34	90	6/24
18985	ZR18985	35	90	6/24
18986	ZR18986	36	90	6/24
18988	ZR18988	38	90	6/24
18991	ZR18991	41	90	5/20
18992	ZR18992	42	90	4/16
18993	ZR18993	43	90	3/12
18996	ZR18996	46	90	2/12
18998	ZR18998	48	90	2/8
18999	ZR18999	50	90	2/8



**1 IMPACT HEX SOCKET BITS 1/2"**

• БИТЫ-ГОЛОВКИ УДАРНЫЕ HEX 1/2" • SCHLAG-INNENSECHSKANT BITS 1/2"



• Made of Cr-Mo steel, adapted to operate the hammer

Code	Code on the suspension	Size (mm)	L (mm)	Box
18400	ZR18400	5	60	100/200
18401	ZR18401	6	60	100/200
18402	ZR18402	7	60	100/200
18403	ZR18403	8	60	100/200
18404	ZR18404	10	60	80/160
18405	ZR18405	12	60	80/160
18406	ZR18406	14	60	80/160
18407	ZR18407	17	60	50/100
18408	ZR18408	19	60	50/100
18409	ZR18409	5	78	100/200
18431	ZR18431	6	78	100/200
18433	ZR18433	7	78	80/160
18434	ZR18434	8	78	80/160
18435	ZR18435	10	78	80/160
18436	ZR18436	12	78	50/100
18437	ZR18437	14	78	50/100
18438	ZR18438	17	78	50/100
18439	ZR18439	19	78	40/80

**2 IMPACT TORX SOCKET BITS 1/2"**

• БИТЫ-ГОЛОВКИ УДАРНЫЕ TORX 1/2" • SCHLAG-TORX-STECKSCHLÜSSEL-BIT/S1/2"



• Made of Cr-Mo steel, adapted to operate the hammer

Code	Code on the suspension	Size	L (mm)	Box
18461	ZR18461	T30	60	100/200
18463	ZR18463	T40	60	100/200
18464	ZR18464	T45	60	100/200
18465	ZR18465	T50	60	100/200
18466	ZR18466	T55	60	80/160
18467	ZR18467	T60	60	80/160
18496	ZR18496	T70	60	80/160
18497	ZR18497	T80	60	80/160
18468	ZR18468	T30	78	100/200
18469	ZR18469	T40	78	100/200
18470	ZR18470	T45	78	80/160
18474	ZR18474	T50	78	80/160
18475	ZR18475	T55	78	50/100
18476	ZR18476	T60	78	50/100

**3 IMPACT TORX SOCKET 1/2"**

• ГОЛОВКИ УДАРНЫЕ TORX 1/2" • SCHLAG-TORX-STECKSCHLÜSSEL 1/2"



• Made of Cr-Mo steel, adapted to operate the hammer

Code	Code on the suspension	Size (mm)	L (mm)	Box
18477	ZR18477	E10	60	90/180
18479	ZR18479	E11	60	90/180
18480	ZR18480	E12	60	90/180
18485	ZR18485	E14	60	90/180
18486	ZR18486	E16	60	90/180
18487	ZR18487	E18	60	90/180
18488	ZR18488	E20	60	75/150

**4 8 PC. IMPACT HEX SOCKET SETS 1/2"**

• НАБОРЫ 8 ШТ. БИТ-ГОЛОВОК УДАРНЫХ HEX 1/2" • 8 STK. SCHLAG-INNENSECHSKANT STECKSCHLÜSSEL-SATZ 1/2"



• Made of Cr-Mo steel, adapted to operate the hammer

Code	Size (mm)	Package	Box
18489	5, 6, 8, 10, 12, 14, 17, 19	rail/cardboard	20
18491	5, 6, 8, 10, 12, 14, 17, 19	plastic box	10

**5 8 PC. IMPACT TORX SOCKET SETS 1/2"**

• НАБОРЫ 8 ШТ. БИТ-ГОЛОВОК УДАРНЫХ TORX 1/2" • 8 STK. SCHLAG-TORX STECKSCHLÜSSEL-SATZ 1/2"



• Made of Cr-Mo steel, adapted to operate the hammer

Code	Type	Package type	Box
18492	T30, T40, T45, T50, T55, T60, T70, T80	rail/cardboard	20
18493	T30, T40, T45, T50, T55, T60, T70, T80	plastic box	10

**6 IMPACT EXTENSION BARS**

• УДЛИНИТЕЛИ УДАРНЫЕ • SCHLAG-VERLÄNGERUNGEN



• Enable work in places difficult to access  
• Made from strong CrMo steel thanks to which they do not break during impact work

Code	Code on the suspension	Socket	L (mm)	Box
<b>1/2"</b>				
18471	ZR18471	1/2"	75	40/160
18472	ZR18472	1/2"	125	28/112
18473	ZR18473	1/2"	250	30/60

<b>3/4"</b>				
18901	ZR18901	3/4"	100	5/20
18902	ZR18902	3/4"	175	8/16
18903	ZR18903	3/4"	250	6/12
18904	ZR18904	3/4"	330	5/20

**7 IMPACT UNIVERSAL JOINTS**

• КАРДАНЫ УДАРНЫЕ • SCHLAG-KUGELGELENKE



• Enable to work at 0 to 25 degrees

Code	Code on the suspension	Socket	L (mm)	Box
18478	ZR18478	1/2"	63	25/100
18906	ZR18906	3/4"	102	4/32

**8 IMPACT ADAPTORS**

• УДАРНЫЕ АДАПТЕРЫ-ПЕРЕХОДНИКИ • SCHLAG-VERBINDUNGSSTÜCKE (REDUKTIONEN)

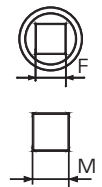

• Enable cooperation of ratchets, sockets and other accessories with different dimensions

Code	Code on the suspension	Socket (F)	Foot (M)	Box
18481	ZR18481	1/2"	3/8"	60/240
18482	ZR18482	1/2"	3/4"	40/160
18484	ZR18484	3/4"	1/2"	12/48
18907	ZR18907	3/4"	1"	12/48

PROLINE  
LIGHT PRO  
MEGA  
JUSSO  
OTHER BRANDS  
ENDI  
KILINGSPOR  
EXPRESS  
ACTION CAR  
TRYTON  
VULCAN

**1 IMPACT SOCKET SETS**

• НАБОР УДАРНЫХ ТОРЦЕВЫХ ГОЛОВОК • SCHLAG-STECKSCHLÜSSELSÄTZE



**1/2"** **3/4"** **CrMo** **PRO**  
SCM-440 **DRIVE**

- 18490 - 1/2" - 10, 12, 13, 14, 15, 16, 17, 18, 19, 22 (L = 39) • 18908 - 3/4" - 22, 24, 27, 30, 31 (L = 52) • 41 (L = 62)
- Delivered in metal boxes

Code	Square	Range (mm)	Quantity (pcs)	
18490	1/2"	10 - 22	10	12
18908	3/4"	22 - 41	8	4

**2 DEEP IMPACT SOCKET SETS**

• НАБОР УДАРНЫХ ТОРЦЕВЫХ ГОЛОВОК УДЛИНЕННЫХ • SCHLAG-STECKSCHLÜSSELSÄTZE VERLÄNGERT



**1/2"** **3/4"** **CrMo** **PRO**  
SCM-440 **DRIVE**

- 18494 - 1/2" - 10, 12, 13, 14, 15, 16, 17, 18, 19, 23, 24 (L = 78) • 18495 - 1/2" - 10, 12, 13, 14, 15, 16, 17, 18, 19, 21, 22, 24, 27, 30, 32 mm (L = 78) • 18909 - 3/4" - 22, 24, 27, 30, 32, 36 • (L = 90) • 38, 41 mm (L = 92) • Delivered in metal boxes

Code	Square	Range (mm)	Quantity (pcs)	
18494	1/2"	10 - 24	11	8
18495	1/2"	10 - 32	15	4
18909	3/4"	22 - 41	8	3

**1 RATCHET COMBINATION SPANNERS** PROLINE HD®

• КОМБИНИРОВАННЫЕ ТРЕЩОТЧНЫЕ КЛЮЧИ • MAULRINGSSCHLÜSSEL MIT RATSCH

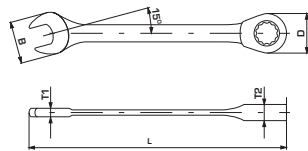

• Forged • Chromium-plated • Satin • Minimum work angle: 5°

Code	Size (mm)	L (mm)	B (mm)	D (mm)	T1 (mm)	T2 (mm)	BOX	SET
35468	8	134.4	16.7	17.1	4.7	7.4	x	10/100
35469	9	158.5	21.0	21.0	5.5	7.4	x	10/100
35470	10	158.5	21.0	21.0	5.5	7.4	x	10/100
35471	11	164.6	23.0	22.6	6.0	8.7	x	10/100
35472	12	167.7	25.0	23.8	6.2	8.7	x	10/100
35473	13	177.4	27.5	24.9	6.0	8.7	x	10/100
35474	14	189.5	29.0	27.0	7.0	8.7	x	10/100
35475	15	198.4	31.5	28.1	7.2	10.3	x	10/100
35476	16	205.4	33.0	29.9	7.5	10.3	x	10/100
35477	17	224.4	34.9	31.9	8.0	10.3	x	10/100
35478	18	235.4	36.5	33.4	8.6	10.6	x	10/100
35479	19	246.4	38.9	34.4	8.8	10.6	x	8/80

**3 FLEXIBLE RATCHET COMBINATION SPANNERS** PROLINE HD®

• КОМБИНИРОВАННЫЕ ТРЕЩОТЧНЫЕ КЛЮЧИ С ШАРНИРОМ • MAULRINGSSCHLÜSSEL MIT RATSCH UND GELENK

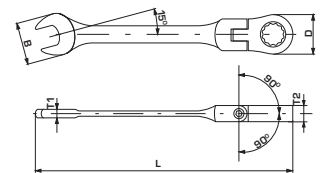

• Forged • Chromium-plated • Satin • Joint range of motion: ±90°  
• Minimum work angle: 15°

Code	Size (mm)	L (mm)	B (mm)	D (mm)	T1 (mm)	T2 (mm)	BOX	SET
35448	8	135	17.0	17.4	4.9	7.4	x	10/100
35449	9	158	20.8	20.9	5.8	7.4	x	10/100
35450	10	160	20.8	20.9	5.8	7.4	x	10/100
35451	11	175	25.1	23.4	6.2	8.7	x	10/100
35452	12	175	25.1	23.4	6.2	8.7	x	10/100
35453	13	185	27.2	24.9	6.4	8.7	x	10/100
35454	14	193	29.3	27.4	7.0	8.7	x	10/100
35455	15	220	33.0	30.4	7.4	10.3	x	10/100
35456	16	213	33.0	30.4	7.4	10.3	x	10/100
35457	17	230	35.2	31.9	8.2	10.3	x	10/100
35458	18	249	39.4	34.5	9.0	10.5	x	10/80
35459	19	250	39.4	34.5	9.0	10.5	x	10/80

**2 FLEXIBLE RATCHET COMBINATION SPANNERS SET** PROLINE HD®

• НАБОР КОМБИНИРОВАННЫХ ТРЕЩОТЧНЫХ КЛЮЧЕЙ  
• FLEXIBLER KNARREN-KOMBINATIONSSCHLÜSSEL SET



• Forged • Chromium-plated • Satin • Minimum work angle: 5°  
• 7 pcs.: 8, 10, 12, 13, 14, 17, 19 mm

Code	Quantity (pcs)	Range (mm)	BOX	SET
35487	7	8 - 19	x	20

**4 FLEXIBLE RATCHET COMBINATION SPANNERS SET** PROLINE HD®

• НАБОР КОМБИНИРОВАННЫХ ТРЕЩОТЧНЫХ КЛЮЧЕЙ С ШАРНИРОМ  
• FLEXIBLER KNARREN-KOMBINATIONSSCHLÜSSEL SET



• Forged • Chromium-plated • Satin • Joint range of motion: ±90°  
• Minimum work angle: 5° • 7 pcs.: 8, 10, 12, 13, 14, 17, 19 mm

Code	Quantity (pcs)	Range (mm)	BOX	SET
35497	7	8 - 19	x	20

PROLINE

LANITI PRO

MEGA

JUCO

OTHER BRANDS

ERDI

KUNGSFOR

EXPRESS

ACTION CAN

TRAYTON

VULCAN

### 1 RATCHET COMBINATION SPANNERS WITH SWITCH

PROLINE HD®

• КОМБИНИРОВАННЫЕ ТРЕЩОТЧНЫЕ КЛЮЧИ С ПЕРЕКЛЮЧАТЕЛЕМ  
• KNARREN-KOMBINATIONSSCHLÜSSEL MIT SCHALTER



**10** YEAR WARRANTY  
**72** TPI  
**CrV** 6140  
**HRC** 44±2

- Forged • Chromium-plated • Satin • Minimum work angle: 5°
- Ratchet mechanism reversible by a switch

Code	Size (mm)	L (mm)	B (mm)	D (mm)	T1 (mm)	T2 (mm)	T (mm)	C (mm)		
35688	8	135	18.5	17.7	7.7	5.1	3.0	8.3	x	10/100
35689	9	142	20.5	19.1	7.7	5.3	3.3	9.2	x	10/100
35690	10	158	22.5	21.2	8.2	5.8	3.6	9.8	x	10/100
35691	11	167	25.0	22.6	8.2	5.9	3.9	11.2	x	10/100
35692	12	173	26.9	23.8	8.8	6.1	4.1	11.9	x	10/100
35693	13	179	29.0	25.9	8.9	6.6	4.4	12.5	x	10/100
35694	14	189	31.5	27.7	9.3	7.5	4.8	13.1	x	10/100
35695	15	199	34.0	29.2	9.4	7.9	5.0	14.5	x	10/100
35696	16	215	35.7	31.8	9.9	7.9	5.2	15.1	x	10/100
35697	17	232	38.3	34.1	10.6	8.0	5.4	15.7	x	10/50
35698	18	238	40.1	34.0	11.0	8.5	5.5	16.0	x	10/50
35699	19	247	42.0	35.1	11.2	8.9	6.0	17.7	x	10/50

### 3 RATCHET RING SPANNERS

PROLINE HD®

• КЛЮЧИ НАКИДНЫЕ С ТРЕЩОТКОЙ • KNARREN-RINGSCHLÜSSEL

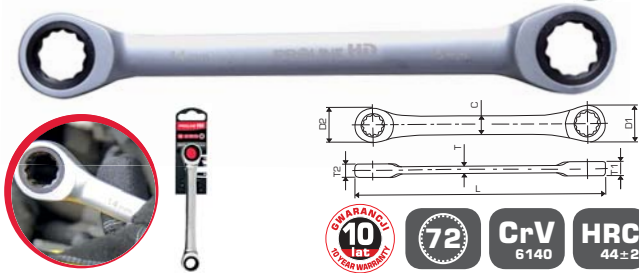

**10** YEAR WARRANTY  
**72** TPI  
**CrV** 6140  
**HRC** 44±2

- Forged • Chromium-plated • Satin • Minimum work angle: 5°

Code	Size (mm)	L (mm)	D1 (mm)	D2 (mm)	T1 (mm)	T2 (mm)	T (mm)	C (mm)		
36658	8 x 9	128	21.0	17.5	7.7	7.0	4.0	10.6	x	20/100
36659	8 x 10	128	21.0	17.5	7.7	7.0	4.0	10.6	x	20/100
36660	10 x 13	160	26.0	21.0	9.3	7.7	4.7	12.8	x	20/100
36662	12 x 13	170	26.0	24.0	9.3	8.7	4.7	12.8	x	20/100
36664	14 x 15	190	30.7	27.7	10.0	9.4	5.4	15.4	x	20/100
36666	16 x 18	230	34.8	32.6	11.2	10.6	6.3	17.4	x	20/100
36667	17 x 19	230	34.8	32.6	11.5	10.9	6.3	17.4	x	20/100
36670	20 x 24	290	47.5	42.0	14.5	13.0	7.0	20.6	x	10/50
36672	22 x 24	290	47.5	42.0	14.5	13.0	7.0	20.6	x	10/50

### 5 4 IN 1 RATCHET SPANNERS

PROLINE HD®

• КЛЮЧИ С ТРЕЩОТКОЙ «4 В ОДНОМ» • 4 IN 1 KNARRENSCHLÜSSEL

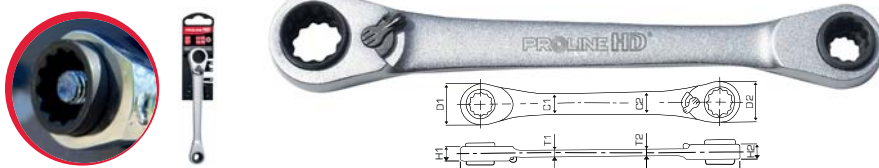

**10** YEAR WARRANTY  
**4in1**  
**72** TPI  
**CrV** 6140  
**HRC** 44±2

- Forged • Chromium-plated • Satin • Minimum work angle: 5° • Four dimensions in a single spanner with a mechanism reversible by a switch

Code	Size (mm)	L (mm)	D1 (mm)	D2 (mm)	H1 (mm)	H2 (mm)	C1 (mm)	C2 (mm)	T1 (mm)	T2 (mm)		
36811	8 x 10 x 12 x 13	160	21.5	26.5	8.9	9.8	10.1	12.8	3.4	4.0	x	10/100
36812	10 x 13 x 17 x 19	210	26.5	35.6	9.8	12.2	15.3	18.0	4.0	5.8	x	5/50
36813	16 x 17 x 18 x 19	230	34.5	35.6	11.7	12.2	16.0	18.0	5.2	5.8	x	5/50

### 2 STUBBY RATCHET COMBINATION SPANNERS

PROLINE HD®

• КОМБИНИРОВАННЫЕ ТРЕЩОТЧНЫЕ КЛЮЧИ КОРОТКИЕ  
• KURZE KNARREN-KOMBINATIONSSCHLÜSSEL



**10** YEAR WARRANTY  
**72** TPI  
**CrV** 6140  
**HRC** 44±2

- Forged • Chromium-plated • Satin • Minimum work angle: 5°

Code	Size (mm)	L (mm)	D (mm)	B (mm)	T1 (mm)	T2 (mm)	T (mm)	C (mm)		
35378	8	88	17.5	18	7.0	5.1	3.2	8.6	x	20/100
35380	10	96	21	21.3	7.7	5.5	4	10.6	x	20/100
35381	11	100	22.7	23.7	8.3	5.9	4.3	11.5	x	20/100
35382	12	104	24	25.4	8.7	6.1	4.5	12.2	x	20/100
35383	13	108	26	26.8	9.3	6.3	4.7	12.8	x	20/100
35384	14	114	27.7	29.8	9.4	6.7	5.2	14.2	x	20/100
35385	15	118	29.1	31.6	10.0	7.1	5.3	14.8	x	20/100
35386	16	122	30.7	33.8	10.6	7.9	5.4	15.4	x	20/100
35387	17	128	32.6	36.2	10.9	7.8	5.6	16.0	x	20/100
35389	19	138	34.8	40	11.5	8.5	6.3	17.4	x	20/100

### 4 RATCHET RING SPANNERS SET

PROLINE HD®

• НАБОР КЛЮЧЕЙ НАКИДНЫХ С ТРЕЩОТКОЙ • KNARREN-RINGSCHLÜSSEL-SATZ



**10** YEAR WARRANTY  
**72** TPI  
**CrV** 6140  
**HRC** 44±2

- Forged • Chromium-plated • Satin • Minimum work angle: 5°
- 5 pcs.: 8x10, 12x13, 14x15, 16x18, 17x19 mm

Code	Quantity (pcs)	Range (mm)	BOX	
36650	5	8 - 19	x	10

**1 COMBINATION SPANNERS**

• КОМБИНИРОВАННЫЕ ГАЕЧНЫЕ РОЖКОВО-НАКЛЮЧНЫЕ КЛЮЧИ • MAULRINGSSCHLÜSSEL

PROLINE HD®



CrV 6140

DIN 3113

HRC 47±2

- Forged • Chromium-plated • Satin • Meet the dimension-related requirements of German DIN 3113 standard • The maximum torque is 60% higher than in German DIN 899 and in US ANSI standard

Code	Size (mm)	L (mm)	B (mm)	D (mm)	T1 (mm)	T2 (mm)	BOX	CUB
35606	6	109	14.5	10.2	3.5	5.3	x	15/90
35607	7	110	16.3	11.2	3.6	5.3	x	15/90
35608	8	120	18.7	12.7	4.0	5.8	x	15/90
35609	9	130	20.8	14.0	4.1	6.6	x	15/90
35610	10	140	22.7	15.1	4.6	7.0	x	15/90
35611	11	159	24.7	16.7	5.0	7.5	x	15/90
35612	12	160	27.2	17.9	5.1	8.1	x	15/90
35613	13	170	28.8	19.7	5.8	8.7	x	15/90
35614	14	180	31.4	20.6	6.0	9.0	x	15/90
35615	15	199	33.3	22.2	6.4	9.3	x	15/90
35616	16	200	35.1	23.7	6.6	10.0	x	15/60
35617	17	210	37.6	24.9	6.8	11.0	x	15/60
35618	18	220	39.6	26.5	7.6	11.5	x	15/60
35619	19	230	41.4	27.9	7.8	12.2	x	15/60
35620	20	240	44.2	29.7	8.1	12.5	x	15/60
35621	21	250	46.2	30.7	8.4	12.8	x	10/40
35622	22	260	48.3	32.1	8.8	13.2	x	10/40
35623	23	270	49.9	33.5	9.0	13.5	x	10/40
35624	24	280	51.5	34.2	9.4	13.5	x	10/40
35625	25	290	54.7	36.7	9.6	14.3	x	10/40
35626	26	300	56.4	37.2	9.8	15.0	x	10/40
35627	27	310	58.8	39.5	10.2	16.5	x	10/40
35628	28	320	59.5	40.6	10.6	17.0	x	10/40
35629	29	339	61.0	41.6	10.8	17.5	x	5/20
35630	30	340	63.1	43.2	11.1	18.5	x	5/20
35632	32	360	67.4	44.7	11.6	19.5	x	5/20
35634	34	470	69.8	48.7	12.6	19.5	x	2/8
35636	36	510	73.8	52.7	13.6	20.5	x	2/8
35638	38	439	73.8	52.7	13.6	20.5	x	2/8
35641	41	550	83.8	60.7	15.6	21.5	x	3/6
35646	46	549	93.5	69.5	17.2	22.5	x	3/6
35650	50	549	98.8	73.7	17.5	22.5	x	3/6

**2 COMBINATION SPANNER SETS**

• НАБОРЫ КОМБИНИРОВАННЫХ ГАЕЧНЫХ РОЖКОВЫХ КЛЮЧЕЙ • MAULRINGSSCHLÜSSELSÄTZE

PROLINE HD®



CrV 6140

DIN 3113

HRC 47±2

- Forged • Chromium-plated • Satin • Meet the dimension-related requirements of German DIN 3113 standard • The maximum torque is 60% higher than in German DIN 899 and in US ANSI standard
- **12 pcs.:** 6, 8, 9, 10, 12, 13, 14, 15, 17, 18, 19, 22 mm • **24 pcs.:** 6, 7, 8, 9, 10, 11, 12, 13, 14, 15, 16, 17, 18, 19, 20, 21, 22, 23, 24, 26, 27, 28, 30, 32 mm

Code	Quantity (pcs)	Range (mm)	BOX	CUB
35662	12	6 - 22	x	10
35664	24	6 - 32	x	8

**3 DOUBLE OPEN END SPANNERS**

• КЛЮЧИ ГАЕЧНЫЕ РОЖКОВЫЕ • MAULSCHLÜSSEL

PROLINE HD®



CrV 6140

DIN 3110

HRC 47±2

- Forged • Chromium-plated • Satin • Meet the dimension-related requirements of German DIN 3110 standard • The maximum torque is 60% higher than in German DIN 899 and in US ANSI standard

Code	Size (mm)	L (mm)	B1 (mm)	B2 (mm)	T (mm)	BOX	CUB
34006	6 x 7	123	14.2	17.4	3.4	x	10/60
34008	8 x 9	140	18.1	21.3	3.7	x	10/60
34009	8 x 10	145	18.1	21.3	4.2	x	10/60
34010	10 x 11	156	22.1	25.6	4.7	x	10/60
34012	12 x 13	172	27.6	30.1	5.2	x	10/60
34013	10 x 13	174	26.5	30.1	5.2	x	10/60
34014	14 x 15	190	31.6	33.6	5.7	x	10/60
34016	16 x 17	204	36.1	38.1	6.2	x	10/40
34019	17 x 19	223	40.1	42.1	6.7	x	10/40
34018	18 x 19	221	40.1	42.1	6.8	x	10/40
34022	19 x 22	236	44.1	48.1	7.5	x	10/40
34020	20 x 22	237	44.1	48.1	7.5	x	10/40
34021	21 x 23	246	44.1	50.1	7.7	x	10/40
34024	24 x 27	263	53.1	57.6	8.4	x	10/40
34025	25 x 28	267	53.1	57.6	8.4	x	10/40
34027	27 x 32	294	62.1	68.1	9.4	x	10/40
34030	30 x 32	294	64.1	68.1	9.4	x	10/40

**4 DOUBLE OPEN END SPANNER SETS**

• НАБОРЫ ГАЕЧНЫХ РОЖКОВЫХ КЛЮЧЕЙ • MAULSCHLÜSSELSÄTZE

PROLINE HD®



CrV 6140

DIN 3110

HRC 47±2

- Forged • Chromium-plated • Satin • Meet the dimension-related requirements of German DIN 3110 standard • The maximum torque is 60% higher than in German DIN 899 and in US ANSI standard
- **6 pcs.:** 6x7, 8x9, 10x11, 12x13, 14x15, 16x17 mm
- **8 pcs.:** 6x7, 8x9, 10x11, 12x13, 14x15, 16x17, 18x19, 20x22 mm

Code	Quantity (pcs)	Range (mm)	BOX	CUB
34036	6	6x7 - 16x17	x	30
34038	8	6x7 - 20x22	x	20

PROLINE

LANITI PRO

MEGA

JUCO

OTHER BRANDS

ERDI

KUNGSFOR

EXPRESS

ACTION CAN

TRAYTON

VULCAN

### 1 DOUBLE OPEN END SPANNERS FOR MICROMECHANICAL WORKS

- РОЖКОВЫЕ ГАЕЧНЫЕ КЛЮЧИ ДЛЯ МИКРОМЕХАНИКИ
- DOPPELMAULSCHLÜSSEL FÜR MIKROMECHANISCHE ARBEITEN

PROLINE HD®

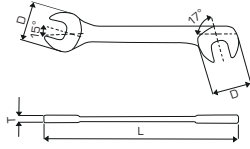

**CrV**  
6140 **HRC**  
46±2

- Forged • Chromium-plated • Satin • Heads of the same size tilted 75° and 15° and a short, thin handle enable to work in places difficult to reach

Code	Size (mm)	L (mm)	D (mm)	T (mm)		
34054	4	70	10.0	2.4	x	20/200
34055	5	75	13.0	2.4	x	20/200
34056	6	80	15.0	2.7	x	20/200
34057	7	80	15.0	2.7	x	20/200
34058	8	90	18.5	3.0	x	20/200
34059	9	90	18.5	3.0	x	20/200
34060	10	100	22.0	3.0	x	20/200
34061	11	100	22.0	3.0	x	20/200
34062	12	120	27.0	3.5	x	20/200
34063	13	120	27.0	3.5	x	20/200
34064	14	120	27.0	3.5	x	20/100
34065	15	139.4	32.5	4.8	x	20/100
34066	16	139.4	32.5	4.8	x	10/100
34067	17	139.4	32.5	4.8	x	10/100

### 2 STRAIGHT RING SPANNERS

- КЛЮЧИ НАКИДНЫЕ ПРЯМЫЕ • GERADE RINGSCHLÜSSEL

PROLINE HD®

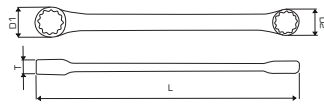

**CrV**  
6140 **DIN**  
837 **HRC**  
46±2

- Forged • Chromium-plated • Satin

Code	Size (mm)	L (mm)	C (mm)	B (mm)	C' (mm)		
36606	6 x 7	120	12.0	10.8	5.5	x	20/200
36608	8 x 9	135	16.5	13.2	6.5	x	20/200
36610	10 x 11	150	19.8	16.5	7.5	x	20/200
36612	12 x 13	165	22.0	19.8	8.5	x	20/100
36614	14 x 15	185	25.0	22.0	8.5	x	20/100
36616	16 x 17	210	26.5	25.0	9.5	x	20/100
36618	18 x 19	225	28.6	27.6	10.5	x	10/50
36620	20 x 22	240	33.6	30.5	12.5	x	5/50
36621	21 x 23	255	35.2	32.0	12.5	x	5/50
36624	24 x 26	270	39.2	36.5	12.5	x	5/40
36625	25 x 28	285	41.4	37.8	13.5	x	5/40
36630	30 x 32	335	48.0	45	14.5	x	5/20

### 3 RING SPANNERS

- КЛЮЧИ ГАЕЧНЫЕ НАКИДНЫЕ ИЗОГНУТЫЕ
- GERADE RINGSCHLÜSSEL

PROLINE HD®

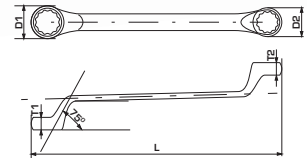
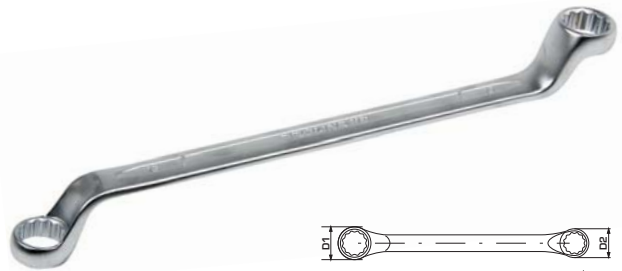

**CrV**  
6140 **DIN**  
838 **HRC**  
47±2

- Forged • Chromium-plated • Satin • Meet the dimension-related requirements of German DIN 3110 standard • The maximum torque is 60% higher than in German DIN 899 and in US ANSI standard

Code	Size (mm)	L (mm)	D1 (mm)	D2 (mm)	T1 (mm)	T2 (mm)		
36006	6 x 7	167	12.0	10.5	6.0	5.3	x	5/30
36008	8 x 9	182	15.0	13.5	7.0	6.3	x	5/30
36010	10 x 11	198	18.0	16.5	8.5	7.3	x	5/30
36012	12 x 13	217	21.0	19.5	9.0	8.7	x	5/20
36014	14 x 15	239	23.5	22.0	9.5	9.0	x	5/20
36016	16 x 17	204	26.5	25.5	11.0	10.5	x	5/20
36018	18 x 19	290	29.5	27.3	12.0	11.0	x	5/20
36020	20 x 22	316	34.5	31.5	13.0	12.0	x	5/20
36021	21 x 23	316	35.0	32.0	13.0	12.0	x	5/20
36024	24 x 27	345	41.2	37.2	14.1	12.5	x	2/8
36025	25 x 28	345	43.0	39.5	14.5	13.5	x	2/8
36030	30 x 32	360	48.5	45.3	16.5	15.0	x	2/8

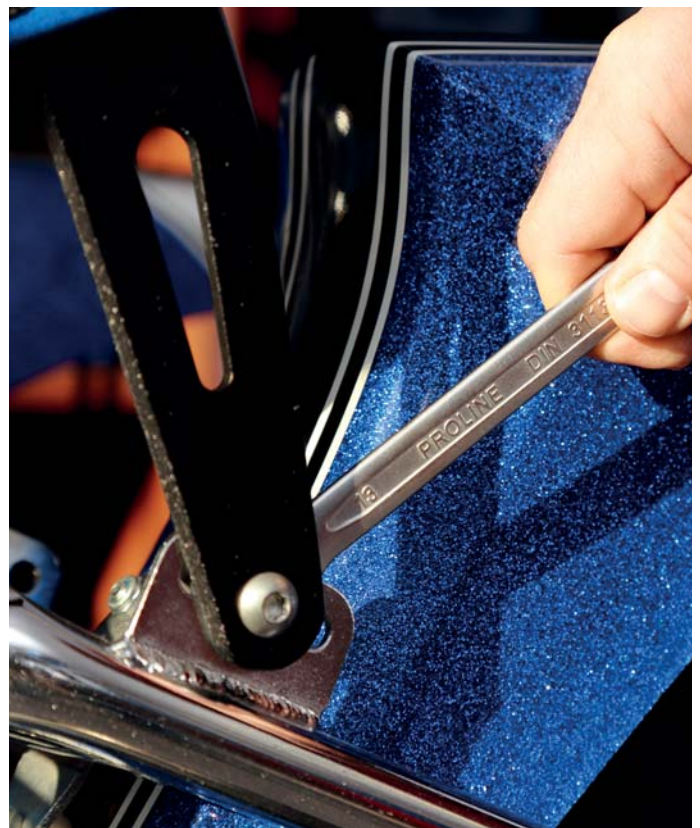

**1 'C' TYPE RING SPANNERS**

• КЛЮЧИ ГАЕЧНЫЕ НАКИДНЫЕ ИЗГНУТЫЕ (СТАРТЕРНЫЕ) • RINGSCHLÜSSEL TYP C

PROLINE HD®

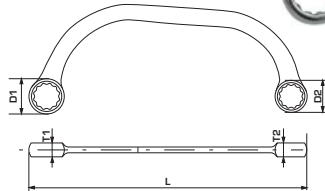

**CrV**  
6140 **HRC**  
46±2

• Forged • Chromium-plated • Satin

Code	Size (mm)	L (mm)	D1 (mm)	D2 (mm)	T1 (mm)	T2 (mm)		
36068	8 x 10	137	14.3	15.6	6.5	6.2	x	10/200
36070	10 x 12	141	18.2	15.6	6.6	6.5	x	10/200
36071	11 x 13	166	21.0	18.2	8.2	8.0	x	10/100
36073	13 x 15	190	25.0	22.0	9.2	8.2	x	10/100
36074	14 x 17	190	25.0	22.0	9.2	8.2	x	10/100
36079	19 x 22	256	32.5	28.6	11.1	10.1	x	6/60

**2 FLARE NUT SPANNERS**

• КЛЮЧИ ГАЕЧНЫЕ НАКИДНЫЕ С РАЗРЕЗОМ • DOPPELRINGSCHLÜSSEL

PROLINE HD®

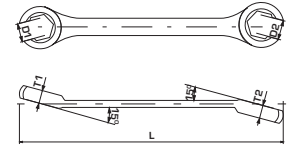

**CrV**  
6140 **DIN**  
3118 **HRC**  
46±2

• Forged • Chromium-plated • Satin

Code	Size (mm)	L (mm)	D1 (mm)	D2 (mm)	T1 (mm)	T2 (mm)		
36046	6 x 8	126	4.5	6.0	6.6	8.2	x	10/200
36048	8 x 9	145	6.0	6.5	7.0	8.5	x	10/200
36049	9 x 11	152	6.5	8.5	8.5	9.0	x	10/200
36050	10 x 12	152	7.0	9.0	8.5	9.0	x	10/200
36052	12 x 13	165	9.0	10.0	9.0	10.5	x	10/200
36053	13 x 14	178	10.0	11.0	9.5	11.0	x	10/100
36055	15 x 17	196	12.0	14.0	11.0	12.0	x	10/100
36059	19 x 21	233	15.0	16.0	14.0	16.0	x	10/60
36062	22 x 24	252	17.0	18.0	16.0	17.0	x	10/80

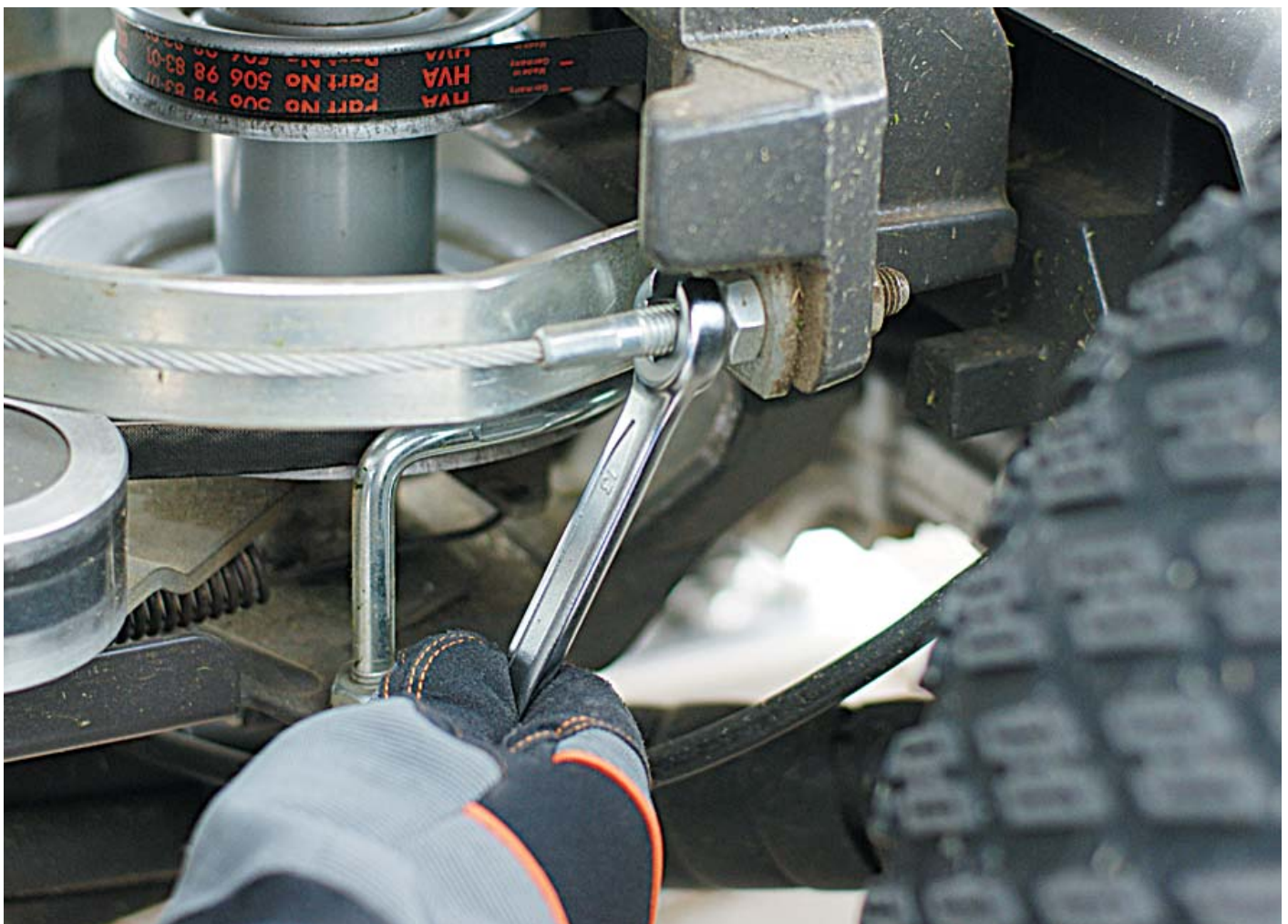

**1 RING TORX SPANNERS**

• КЛЮЧИ НАКИДНЫЕ TORX • RING-TORXSCHLÜSSEL

PROLINE HD®



• Forged • Chromium-plated • Satin

**10** YEAR WARRANTY  
**CrV** 6140 **HRC** 46±2

Code	Size (mm)	L (mm)	D1 (mm)	D2 (mm)	T1 (mm)	T2 (mm)	BOX	BOX
36686	E6 x E8	113	11.2	9.2	5.6	4.6	x	20/200
36690	E10 x E12	142	16.7	14.4	7.8	6.5	x	20/200
36694	E14 x E18	182	21.2	17.2	9.8	8.2	x	20/200
36695	E20 x E24	224	28.7	24.8	13.0	11.0	x	10/100

**2 RING TORX SPANNERS**

• НАБОР КЛЮЧЕЙ НАКИДНЫХ TORX • RING-TORXSCHLÜSSEL

PROLINE HD®



• Forged • Chromium-plated • Satin  
• 4 pcs.: E6x8, E10x12, E14x18, E20x24 mm

**10** YEAR WARRANTY  
**CrV** 6140 **HRC** 46±2

Code	Quantity (pcs)	Range (mm)	BOX	BOX
36680	4	E6 x E8 - E20 x E24	x	10

**3 FLEXIBLE SOCKET COMBINATION SPANNERS**

• КЛЮЧИ ГАЕЧНЫЕ КОМБИНИРОВАННЫЕ РОЖКОВО-ТОРЦЕВЫЕ ШАРНИРНЫЕ • FLEXIBLE STECKSCHLÜSSEL-KOMBINATIONSSCHLÜSSEL

PROLINE HD®

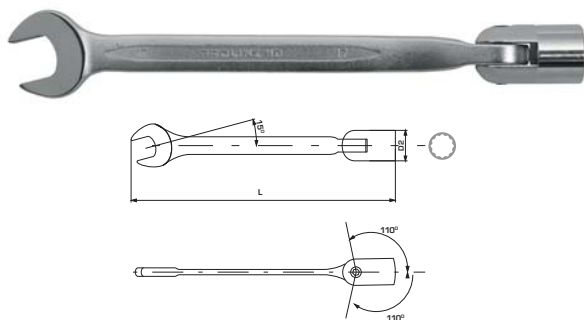

• Forged • Chromium-plated • Satin • Ground heads  
• Socket: 50BV30 • Head range of motion: 220° ±5°

**10** YEAR WARRANTY  
**CrV** 6140 **HRC** 44±2

Code	Size (mm)	L (mm)	D2 (mm)	BOX	BOX
36090	10	180	15	x	30/120
36093	13	210	19	x	25/100
36097	17	235	24	x	25/50
36099	19	235	26	x	25/50

**4 FLEXIBLE SOCKET SPANNERS**

• КЛЮЧИ ШАРНИРНО-ТОРЦЕВЫЕ • FLEXIBLE STECKSCHLÜSSEL

PROLINE HD®

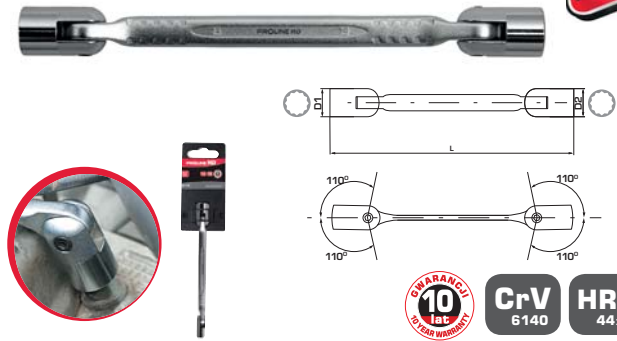

• Forged • Chromium-plated • Satin • Ground heads • Socket: 50BV30  
• Head range of motion: 220° ±5°

**10** YEAR WARRANTY  
**CrV** 6140 **HRC** 44±2

Code	Size (mm)	L (mm)	D1 (mm)	D2 (mm)	BOX	BOX
36136	6 x 7	180	9.5	10.9	x	25/100
36138	8 x 9	180	13.0	14.0	x	25/100
36140	10 x 11	200	15.0	16.0	x	25/100
36142	12 x 13	220	18.0	19.0	x	30/120
36144	14 x 15	242	20.0	22.0	x	25/100
36146	16 x 17	254	24.0	24.0	x	25/50
36147	17 x 19	260	24.0	26.0	x	30/60
36148	18 x 19	275	26.0	26.0	x	25/50
36150	20 x 22	305	28.0	30.5	x	12/24
36151	21 x 23	305	29.8	33.0	x	12/24
36154	24 x 27	335	33.0	37.0	x	12/24
36160	30 x 32	350	40.0	42.0	x	6/12

**5 FLEXIBLE SOCKET SPANNER SET**

• НАБОР ГАЕЧНЫХ НАКИДНЫХ ИЗОГНУТЫХ (СТАРТЕРНЫХ) КЛЮЧЕЙ  
• FLEXIBLER STECKSCHLÜSSEL-SÄTZE

PROLINE HD®



• Forged • Chromium-plated • Satin  
• Ground heads • Socket: 50BV30  
• Head range of motion: 220° ±5°  
• 6 pcs.: 8x9, 10x11, 12x13, 14x15, 16x17, 18x19 mm

**10** YEAR WARRANTY  
**CrV** 6140 **HRC** 44±2

Code	Quantity (pcs)	Range (mm)	BOX	BOX
36166	6	8x9 - 18x19	x	12

PROLINE

LAHTI PRO

MEGA

JUCO

OTHER BRANDS

ERDI

KLINGSPOR

EXPRESS

ACTION CAN

TRAYTON

VULCAN



**1 FLEXIBLE TORX SOCKET SPANNERS**

- КЛЮЧИ КОМБИНИРОВАННЫЕ ТОРЦЕВЫЕ- ТОRX ШАРНИРНЫЕ
- FLEXIBLE TORX-STECKSCHLÜSSEL

PROLINE HD®

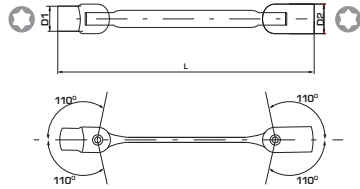

CrV  
6140

HRC  
44±2

- Forged • Chromium-plated • Satin • Socket: 50BV30 • Head range of motion: 220° ±5°

Code	Size (mm)	L (mm)	D1 (mm)	D2 (mm)		
36116	E6 x E8	182	8.3	9.9	x	25/100
36120	E10 x E12	200	12.0	15.0	x	25/100
36124	E14 x E16	220	16.3	19.0	x	25/100
36128	E18 x E20	240	20.5	22.0	x	25/50
36132	E22 x E24	258	25.0	26.0	x	25/50

**2 FLEXIBLE TORX SPANNERS**

- КЛЮЧИ ШАРНИРНЫЕ ТОRX • FLEXIBLE TORX-SCHLÜSSEL

PROLINE HD®

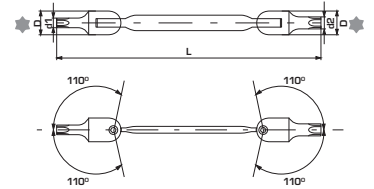

CrV  
6140

HRC  
44±2

- Forged • Chromium-plated • Satin • TORX: 8660V
- Head range of motion: 220° ±5°

Code	Size (mm)	L (mm)	d1 (mm)	d2 (mm)	D (mm)		
36106	T15 x T20	220	3.26	3.8	15	x	25/100
36107	T25 x T27	220	4.40	5.0	15	x	25/100
36108	T30 x T40	220	5.48	6.6	15	x	25/100
36109	T45 x T50	240	7.70	8.8	18	x	25/50
36110	T55 x T60	240	11.17	13.2	18	x	25/50



**3 FLEXIBLE TORX SPANNER SET**

- НАБОР КЛЮЧЕЙ ШАРНИРНЫХ ТОRX • FLEXIBLER TORX-SCHLÜSSELSATZ

PROLINE HD®



CrV  
6140

HRC  
44±2

- Forged • Chromium-plated • Satin • Head range of motion: 220° ±5° • The maximum torque is 30% higher than in German DIN 896 standard
- 5 pcs.: T15xT20, T25xT27, T30xT40, T45xT50, T55xT60

Code	Quantity (pcs)	Range (mm)		
36105	5	T15xT20 - T55xT60	x	12

PROLINE

LANITI PRO

MEGA

JUCO

OTHER BRANDS

ERDI

KUNGSFOR

EXPRESS

ACTION CAN

TRYTON

VULCAN

### 1 FLEXIBLE HOOK „PIN“ WRENCHES

• КЛЮЧИ ШАРНИРНЫЕ ДЛЯ КРУГЛЫХ ШЛИЦЕВЫХ ГАЕК, СО «ШТИФТОМ»  
• FLEXIBELE HAKEN „PIN“ SCHLÜSSEL

PROLINE HD®

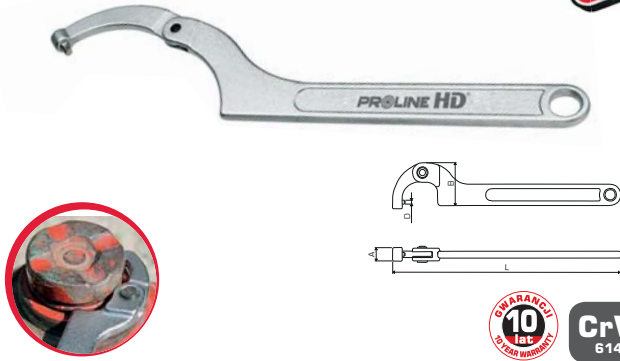

CrV 6140

• Forged • Chromium-plated • Satin

Code	Range (mm)	L (mm)	A (mm)	B (mm)	Ø D (mm)	Box
36805	15-35	168	9.8	31	2.8	10/100
36806	35-50	202	10.7	39	3.8	10/50
36807	50-80	280	14.0	55	4.8	10/50
36808	80-120	345	17.2	75	5.8	10/20
36809	120-180	465	19.2	110	7.8	10

### 2 FLEXIBLE HOOK „CLAW“ WRENCHES

• КЛЮЧИ ШАРНИРНЫЕ ДЛЯ КРУГЛЫХ ШЛИЦЕВЫХ ГАЕК, С «КОГТЕМ»  
• FLEXIBELE HAKEN „KRALLE“ SCHLÜSSEL

PROLINE HD®

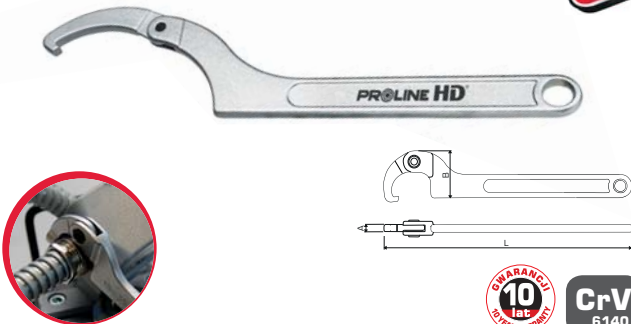

CrV 6140

• Forged • Chromium-plated • Satin

Code	Range (mm)	L (mm)	A (mm)	B (mm)	Box
36800	15-35	168	5.2	31	10/100
36801	35-50	202	5.9	39	10/100
36802	50-80	280	7.5	55	10/50
36803	80-120	345	8.2	75	10/20
36804	120-180	465	10.8	110	10

### 3 'L' TYPE SPANNERS

• КЛЮЧИ ДВОЙНЫЕ ТОРЦЕВЫЕ ИЗОГНУТЫЕ • WINKEL-STECKSCHLÜSSEL DOPPELSEITIG

PROLINE HD®

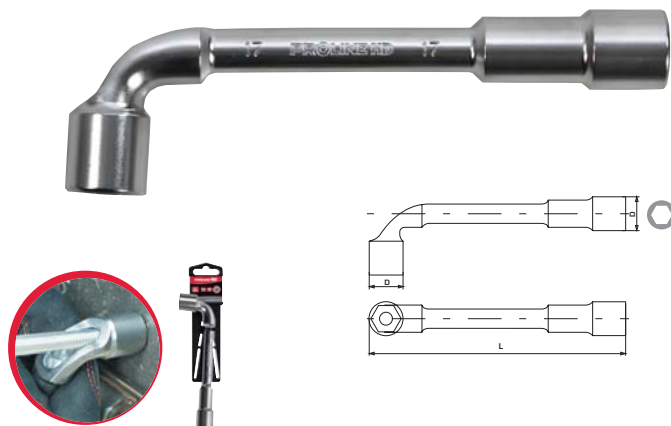

CrV 6140

HRC 46±2

• Forged • Chromium-plated • Satin • With one-side opening

Code	Size (mm)	L (mm)	D (mm)	Box	Box
36168	8	114	12.5	x	10/100
36170	10	129	15.0	x	10/100
36172	12	144	18.0	x	10/100
36173	13	152	19.5	x	10/100
36174	14	160	21.0	x	10/100
36175	15	169	22.5	x	10/60
36177	17	187	25.5	x	10/40
36179	19	204	28.0	x	10/40
36182	22	230	32.0	x	10/20
36184	24	250	34.5	x	10/20
36187	27	280	38.0	x	5/10
36190	30	310	42.0	x	5/10
36192	32	330	44.5	x	5/10

### 4 TUBE SPANNERS

• КЛЮЧИ ТОРЦЕВЫЕ ТРУБЧАТЫЕ • ROHRSCHLÜSSEL

PROLINE HD®



CrV 6140

DIN 896

HRC 42±2

• Forged • Chromium-plated • Satin

Code	Size (mm)	L (mm)	d (mm)	D1 (mm)	D2 (mm)	Box	Box
36216	6 x 7	105	3	10	11	x	20/400
36218	8 x 9	110	3	13	14	x	10/300
36220	10 x 11	120	5	15	16	x	10/300
36222	12 x 13	140	6	18	19	x	10/120
36224	14 x 15	145	6	20	22	x	10/120
36226	16 x 17	155	7	23	24	x	12/120
36228	18 x 19	165	8	25	26	x	10/100
36230	20 x 22	170	8	28	30	x	10/100
36234	24 x 26	190	12	33	35	x	5/40
36237	27 x 29	210	12	37	39	x	5/40
36240	30 x 32	210	13	40	42	x	5/30

### 5 TUBE SPANNER SET

• НАБОР ТОРЦЕВЫХ ТРУБЧАТЫХ КЛЮЧЕЙ • ROHRSCHLÜSSELSATZ DOPPELSEITIG

PROLINE HD®



• Forged • Chromium-plated • Satin  
• 5 pcs.: 8x9, 10x11, 12x13, 14x15, 16x17mm



CrV 6140

DIN 896

HRC 42±2

Code	Quantity (pcs)	Range (mm)	Box	Box
36215	5	8x9 - 16x17	x	10

**1 RING SLUGGING SPANNERS**

• КЛЮЧИ НАКИДНЫЕ УДАРНЫЕ • SCHLAG-RINGSCHLÜSSEL

PROLINE HD®

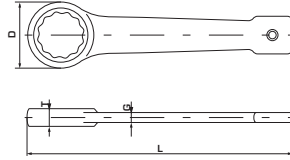

CrMo DIN 7444\*

• Forged • Phosphated • Reinforced slogging head • Made from CrMo steel

\* not applicable to: 36922, 36924, 36938

HRC 38±2

Code	Size (mm)	L (mm)	D (mm)	T (mm)	G (mm)	Box
36922	22	160	42.0	15.5	8.0	5/50
36924	24	162	42.0	15.5	8.0	5/50
36927	27	178	45.5	16.5	9.5	5/50
36930	30	187	51.5	17.0	9.5	5/50
36932	32	190	51.5	17.5	9.5	5/50
36936	36	203	57.0	18.0	10.5	5/40
36938	38	204	57.0	18.0	10.5	5/40
36941	41	230	66.0	21.0	12.0	5/20
36946	46	237	73.0	22.0	13.5	5/20

HRC 34±2

36950	50	253	79.5	24.5	15.5	2/16
36955	55	270	88.0	25.5	16.5	2/12
36960	60	280	93.0	27.5	18.0	2/12
36965	65	280	101.0	28.5	17.5	2/12

**2 WRENCH FOR RING NUTS WITH FRONT HOLES**

• КЛЮЧ ДЛЯ ТОРЦЕВЫХ ГАЕК С ОТВЕРСТИЯМИ • SCHLÜSSEL FÜR RINGMUTTERN MIT FRONTLÖCHERN

PROLINE HD®



18-100 mm

x4

CrV 6140

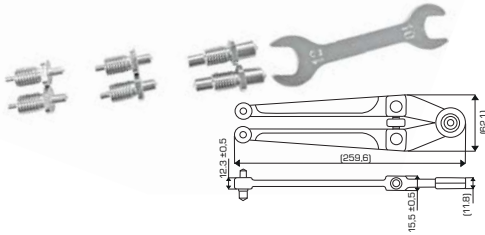

• Forged • Chromium-plated • Satin • Designed for unscrewing and tightening nuts with frontal openings • Adjusted with a knob  
• Adjustment range from 18 to 100 mm • The box contains 4 pairs of replaceable, round and two-sided pins of different sizes and a spanner

Code	Pins' size (mm)	Range (mm)	Box
36810	2.5, 3, 4, 5, 6, 7, 8, 9	18-100	20

Spanners  
**PROLINE HD®**

Forged, chromium-plated, satin



From high quality CrMo steel 6140

### 1 COMBINATION SPANNERS

• КОМБИНИРОВАННЫЕ ГАЕЧНЫЕ РОЖКОВО- НАКИДНЫЕ КЛЮЧИ • MAULRINGSSCHLÜSSEL

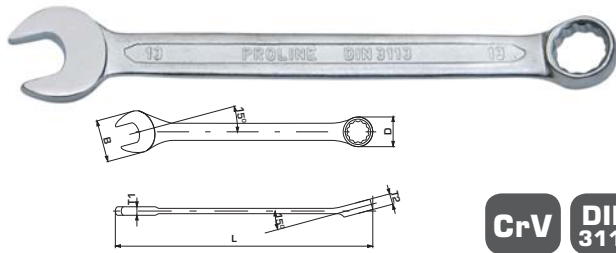

**CrV** **DIN 3113**

• Cold forged • Ground heads • Chromium-plated

Code	Size (mm)	L (mm)	B (mm)	D (mm)	T1 (mm)	T2 (mm)		
35406	6	100	15.0	9.5	3.4	5.2	x	20/600
35407	7	110	17.5	10.5	3.6	5.7	x	20/600
35408	8	120	19.5	12.0	3.8	6.2	x	20/600
35409	9	129	21.5	13.5	4.0	6.7	x	20/400
35410	10	139	22.5	15.0	4.2	7.2	x	20/320
35411	11	149	24.0	16.5	4.5	7.7	x	20/320
35412	12	159	27.0	18.0	4.8	8.2	x	20/240
35413	13	169	29.0	19.5	5.0	8.7	x	20/240
35414	14	179	31.0	21.0	5.2	9.2	x	20/180
35415	15	189	33.0	22.5	6.0	9.7	x	20/180
35416	16	199	33.3	24.0	6.3	10.2	x	20/120
35417	17	209	37.0	25.5	6.7	10.7	x	20/120
35418	18	219	37.3	27.0	7.0	11.2	x	10/120
35419	19	228	39.0	28.5	7.4	11.5	x	10/100
35420	20	238	40.8	30.0	7.8	12.0	x	10/100
35421	21	248	43.0	31.5	8.5	12.5	x	10/80
35422	22	259	47.0	33.0	8.8	13.0	x	10/80
35423	23	269	47.5	34.5	8.7	13.5	x	10/60
35424	24	278	49.0	36.0	8.6	14.0	x	10/60
35427	27	309	57.0	40.5	8.8	15.5	x	10/40
35430	30	338	62.0	43.0	9.2	17.0	x	5/40
35432	32	348	65.0	46.0	9.5	18.0	x	5/40

### 3 DOUBLE OPEN END SPANNERS

• КЛЮЧИ ГАЕЧНЫЕ РОЖКОВЫЕ • MAULSCHLÜSSEL

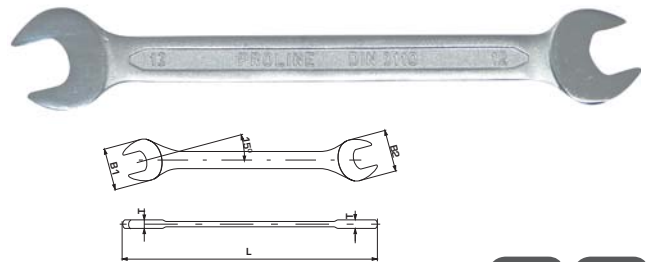

**CrV** **DIN 3110**

• Cold forged • Ground heads • Chromium-plated

Code	Size (mm)	L (mm)	B1 (mm)	B2 (mm)	T (mm)		
34306	6 x 7	123	17.3	15.5	3.5	x	20/600
34308	8 x 9	139	21.2	19.5	3.8	x	20/400
34309	8 x 10	138	21.2	19.2	3.8	x	20/400
34310	10 x 11	155	24.8	21.8	4.5	x	20/320
34312	12 x 13	170	28.0	26.8	5.0	x	20/240
34313	10 x 13	171	28.0	22.3	5.3	x	20/240
34314	14 x 15	188	31.8	30.5	5.3	x	20/160
34316	16 x 17	203	36.8	34.5	6.5	x	20/160
34317	13 x 17	203	36.8	30.5	6.2	x	20/160
34318	18 x 19	222	40.4	38.5	6.3	x	20/120
34319	17 x 19	223	40.4	38.5	6.3	x	20/120
34320	20 x 22	233	44.5	40.5	7.2	x	10/80
34321	21 x 23	251	47.5	43.9	8.2	x	10/80
34322	19 x 22	234	44.8	40.8	7.5	x	10/80
34324	24 x 27	264	55.7	51.0	8.5	x	10/60
34325	25 x 28	280	57.5	52.0	8.5	x	10/40
34327	27 x 32	301	64.5	55.0	9.5	x	10/40
34330	30 x 32	301	64.5	60.5	9.5	x	10/40

### 2 COMBINATION SPANNER SETS

• НАБОР КОМБИНИРОВАННЫХ ГАЕЧНЫХ РОЖКОВО-НАКИДНЫХ КЛЮЧЕЙ • MAULRINGSSCHLÜSSELSATZ



**CrV** **DIN 3113**

- Cold forged • Ground heads • Chromium-plated
- **6 pcs.:** 8, 10, 12, 13, 14, 17 mm
- **8 pcs.:** 6, 8, 10, 12, 13, 14, 17, 19 mm
- **12 pcs.:** 6, 8, 9, 10, 12, 13, 14, 15, 17, 18, 19, 22 mm

Code	Quantity (pcs)	Range (mm)	
35306	6	8 - 17	4/32
35308	8	6 - 19	4/24
35312	12	6 - 22	2/16

### 4 COMBINATION SPANNER SET

• НАБОР КОМБИНИРОВАННЫХ ГАЕЧНЫХ РОЖКОВО-НАКИДНЫХ КЛЮЧЕЙ • MAULRINGSSCHLÜSSELSATZ



**CrV** **DIN 3113**

- Cold forged • Ground heads • Chromium-plated
- **24 pcs.:** 6, 7, 8, 9, 10, 11, 12, 13, 14, 15, 16, 17, 18, 19, 20, 21, 22, 23, 24, 26, 27, 28, 30, 32 mm

Code	Quantity (pcs)	Range (mm)	BOX	
35324	24	6 - 32	x	4

**1 STUBBY COMBINATION SPANNERS**

• КЛЮЧИ НАКИДНЫЕ ПЛОСКИЕ КОРОТКИЕ • KURZE KOMBINATIONSSCHLÜSSEL

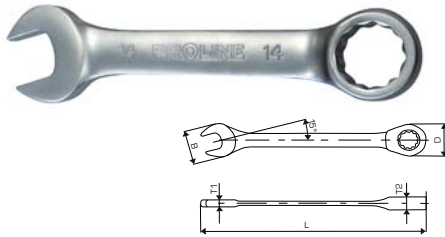
**CrV**

• Forged cold • Chromium-plated

Code	Size (mm)	L (mm)	B (mm)	D (mm)	T1 (mm)	T2 (mm)	BOX	CUB
35348	8	88	17.6	14.2	4.6	6.7	x	10/120
35349	9	92	19.4	15.5	4.7	7	x	10/120
35350	10	101	21.3	16.5	5	7.5	x	10/120
35351	11	106	23.2	18.9	5.6	8	x	10/120
35352	12	109	25	19.8	5.9	8.5	x	10/120
35353	13	115	26.9	20.9	6.2	9	x	10/120
35354	14	118	29.4	22.8	6.4	9.5	x	10/120
35355	15	123	30.2	24.8	6.6	10	x	10/120
35356	16	127	33.4	25.8	6.8	10.5	x	10/120
35357	17	134	35.5	27.2	7.1	11	x	10/120
35358	18	138	37.5	28.7	7.5	11.5	x	10/120
35359	19	140	38	30.2	7.8	12	x	10/120

**2 STUBBY COMBINATION SPANNER SET**• НАБОР КЛЮЧЕЙ НАКИДНЫХ ПЛОСКИХ КОРОТКИХ  
• KURZER KOMBINATIONSSCHLÜSSEL-SATZ• Forged cold • Chromium-plated  
• 6 pcs.: 10, 12, 13, 14, 15, 17 mm**CrV**

Code	Quantity (pcs)	Range (mm)	BOX	CUB
35340	6	10 - 17	x	40

**3 DOUBLE OPEN END SPANNER SETS**

• НАБОР ГАЕЧНЫХ РОЖКОВЫХ КЛЮЧЕЙ • MAULSCHLÜSSELSÄTZE

**CrV** **DIN 3110**

- Cold forged • Ground heads
- Chromium-plated
- 6 pcs.: 6x7, 8x9, 10x11, 12x13, 14x15, 16x17 mm
- 8 pcs.: 6x7, 8x9, 10x11, 12x13, 14x15, 16x17, 18x19, 20x22 mm
- 12 pcs.: 6x7, 8x9, 10x11, 12x13, 14x15, 16x17, 18x19, 20x22, 21x23, 24x27, 25x28, 30x32 mm

Code	Quantity (pcs)	Range (mm)	CUB
34406	6	6x7 - 16x17	4/32
34408	8	6x7 - 20x22	4/16
34412	12	6x7 - 30x32	2/8

**4 RING SPANNERS**

• КЛЮЧИ ГАЕЧНЫЕ НАКИДНЫЕ ИЗОГНУТЫЕ • RINGSCHLÜSSEL GEKRÖPFT

**CrV** **DIN 838**

• Cold forged • Ground heads • Chromium-plated

Code	Size (mm)	L (mm)	D1 (mm)	D2 (mm)	T1 (mm)	T2 (mm)	BOX	CUB
36566	6 x 7	175	12.1	10.4	6.2	5.2	x	20/320
36568	8 x 9	182	14.7	13.4	7.2	6.3	x	20/300
36570	10 x 11	195	17.6	16.2	9.2	8.1	x	10/200
36572	12 x 13	222	20.5	19.2	10.0	9.9	x	10/160
36574	14 x 15	223	23.2	22.0	10.8	10.5	x	10/120
36576	16 x 17	244	26.4	25.2	12.1	11.6	x	10/80
36578	18 x 19	278	29.5	27.5	12.6	12.5	x	10/80
36580	20 x 22	287	33.5	30.5	14.5	13.4	x	10/60
36581	21 x 23	307	34.0	31.2	14.3	12.8	x	5/40
36584	24 x 27	330	40.8	37.5	15.5	14.5	x	5/40
36585	25 x 28	345	42.5	38.2	15.5	14.5	x	5/40
36590	30 x 32	370	47.5	44.3	16.5	16.3	x	5/30

**5 RING SPANNER SETS**

• НАБОР ГАЕЧНЫХ НАКИДНЫХ ИЗОГНУТЫХ КЛЮЧЕЙ • RINGSCHLÜSSELSÄTZE GEKRÖPFT

**CrV** **DIN 838**

- Cold forged • Ground heads • Chromium-plated
- 6 pcs.: 6x7, 8x9, 10x11, 12x13, 14x15, 16x17 mm
- 8 pcs.: 6x7, 8x9, 10x11, 12x13, 14x15, 16x17, 18x19, 20x22 mm
- 12 pcs.: 6x7, 8x9, 10x11, 12x13, 14x15, 16x17, 18x19, 20x22, 21x23, 24x27, 25x28, 30x32 mm

Code	Quantity (pcs)	Range (mm)	BOX	CUB
36506	6	6x7 - 16x17	x	20
36508	8	6x7 - 20x22	x	12
36512	12	6x7 - 30x32	x	4



**1 FLARE NUT SPANNERS**

• ГАЕЧНЫЕ НАКИДНЫЕ КЛЮЧИ С РАЗРЕЗОМ • RINGSCHLÜSSEL OFFEN

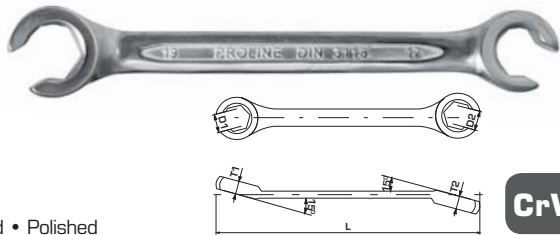

• Forged • Polished

CrV

Code	Size (mm)	L (mm)	D1 (mm)	D2 (mm)	T1 (mm)	T2 (mm)		
36408	8 x 9	140	6.5	5.3	6.1	5.4	x	10/300
36410	10 x 11	152	8.7	7.2	7.7	7.0	x	10/300
36412	12 x 13	160	10.3	9.2	9.7	8.6	x	10/200
36413	13 x 14	170	11.2	10.2	10.3	9.3	x	10/200
36415	15 x 17	195	14.3	12.3	11.3	10.5	x	10/100
36417	17 x 19	209	15.3	14.3	12.8	12.2	x	10/80
36419	19 x 21	229	17.3	15.2	14.2	12.6	x	10/80

**2 FLARE NUT SPANNER SET**

• НАБОР ГАЕЧНЫХ НАКИДНЫХ КЛЮЧЕЙ С РАЗРЕЗОМ • RINGSCHLÜSSELSÄTZE OFFEN



CrV

• Forged • Polished  
• 5 pcs.: 10x11, 12x13, 13x14, 15x17, 17x19 mm

Code	Quantity (pcs)	Range (mm)		
36445	5	10x11 - 17x19	x	20

**3 'C' TYPE RING SPANNERS**

• ГАЕЧНЫЕ НАКИДНЫЕ ДВУСТОРОННИЕ „СТАРТЕРНЫЕ“ КЛЮЧИ • RINGSCHLÜSSEL TYP C

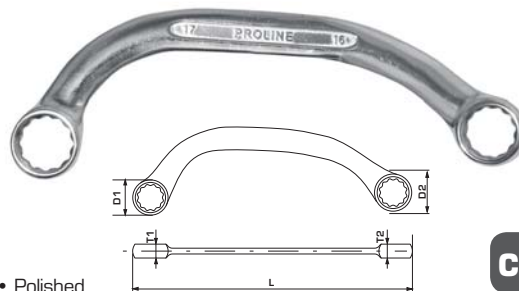

• Forged • Polished

CrV

Code	Size (mm)	L (mm)	D1 (mm)	D2 (mm)	T1 (mm)	T2 (mm)		
36428	8 x 9	150	15.5	15.1	6.7	6.1	x	10/300
36430	10 x 11	150	17.7	17.0	6.7	6.3	x	10/300
36432	12 x 13	150	20.5	18.0	7.0	6.0	x	10/200
36434	14 x 15	185	23.5	22.2	8.0	7.6	x	10/160
36436	16 x 17	186	26.2	25.3	8.0	7.8	x	10/100
36437	17 x 19	185	28.2	26.5	9.8	8.3	x	10/100
36439	19 x 21	221	34.8	33.8	12.7	12.2	x	10/80

**4 'C' TYPE RING SPANNER SET**

• НАБОР ГАЕЧНЫХ НАКИДНЫХ ДВУСТОРОННИХ „СТАРТЕРНЫХ“ КЛЮЧЕЙ • RINGSCHLÜSSELSÄTZE TYP C



CrV

• Forged • Polished  
• 5 pcs.: 10x11, 12x13, 14x15, 16x17, 17x19 mm

Code	Quantity (pcs)	Range (mm)		
36455	5	10x11 - 17x19	x	20

**5 RATCHET SCAFFOLD SPANNER**

• КЛЮЧ ДЛЯ СТРОИТЕЛЬНЫХ ЛЕСОВ С ТРЕЩОТКОЙ • RINGSCHLÜSSEL-SATZ TYP C

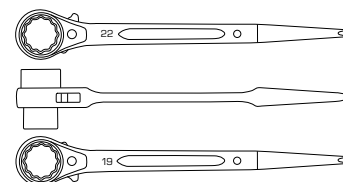

32 CrV

• Forged • Designed especially for works related to scaffolding assembly and dismantling • Chromium-plated • Satin • A long and profiled handle facilitates scaffolding levering and extending • The opening in the handle facilitating spanner fixing and securing during works at height

Code	Size (mm)		
36722	19x22	x	10/40

**1 FLEXIBLE JOINT GLOW PLUG SOCKET SET**

• ТОРЦЕВЫЕ КЛЮЧИ ДЛЯ СВЕЧ НАКАЛИВАНИЯ – НАБОР • FLEXIBLES GELENK GLÜNKERZEN-STECKSCHLÜSSEL-SATZ



**3/8" CrV**

- Spanners for mounting and dismounting glow plugs
- Articulated
- 6 pcs.: 8, 9, 10, 12, 14, 16

Code	Range (mm)	Square	Box
46841	8-16	3/8"	10

**2 OPEN END RING SPANNER SET**

• КЛЮЧИ НАКИДНЫЕ ОТКРЫТЫЕ – НАБОР • MAULSCHLÜSSELSATZ



**1/2" CrMo SCM-440**

- For driving screws and bolts in and out in places hard to reach
- Easy access when removing cables or sensors
- 6 pcs.: 12, 14, 16, 17, 18, 19 mm

Code	Range (mm)	Box
46842	12-19	10

**3 T-TYPE SOCKET WRENCHES**

• КЛЮЧИ ТОРЦЕВЫЕ Т-ОБРАЗНЫЕ • STECKSCHLÜSSEL TYP T



**CrV 300 mm**

Code	Size (mm)	Box
29083	8	25/100
29084	9	25/100
29085	10	25/100
29086	11	25/100
29087	12	25/100
29088	13	25/100
29089	14	25/100
29090	15	20/80
29092	17	20/80

**4 CROSS-RIM WRENCHES**

• КЛЮЧИ БАЛОННЫЕ КРЕСТОВЫЕ • RADMUTTERNSCHLÜSSEL TYP X



**CrV**

- Made from high quality CrV steel
- Wide working range
- For professional applications

Code	Size (mm)	Square	L (mm)	Box	Box
29020	17 x 19 x 21	1/2"	400	x	5/10
29021	24 x 27 x 32	3/4"	600	-	1/6

**5 L-TYPE RIM WRENCH**

• КЛЮЧ БАЛОННЫЙ L-ОБРАЗНЫЙ • RADMUTTERNSCHLÜSSEL TYP L



**CrV**

- Made from high quality CrV steel
- Wide working range
- For professional applications
- The set includes 2 sockets sized 17 x 19 mm and 21 x 23 mm

Code	Size (mm)	Square	L (mm)	Box
29023	17 x 19 21 x 23	1/2"	350 - 530	6/12

PROLINE

LANITI PRO

MEGA

JUCO

OTHER BRANDS

ERDI

KLINGSPOR

EXPRESS

ACTION CAN

TRYTON

VULCAN

**1 CROSS-RIM WRENCH**

• КЛЮЧ БАЛОННЫЙ КРЕСТОВОЙ • RADMUTTERNSCHLÜSSEL TYP X



**CrV**

- Made from high quality CrV steel
- Wide working range • For professional applications

Code	Size (mm)	L (mm)		
29019	17 x 19 x 21 x 22	400	x	5/10

**2 T-TYPE RIM WRENCH**

• КЛЮЧ БАЛОННЫЙ Т-ОБРАЗНЫЙ • RADMUTTERNSCHLÜSSEL TYP T



**CrV**

- Made from high quality CrV steel • Wide working range • For professional applications • The set includes 2 sockets sized 17 x 19 mm and 21 x 23 mm • Case

Code	Size (mm)	Square	L (mm)	
29022	17 x 19 21 x 23	1/2"	400	10

**3 T-TYPE SPARK PLUG WRENCHES**

• КЛЮЧИ БАЛОННЫЕ Т-ОБРАЗНЫЕ • ZÜNDKERZENSCHLÜSSEL TYP T



**285 mm**

**CrV**

- Brass insert protecting the plug

Code	Hexagon (mm)	
29116	16	20/40
29121	21	20/40





### 1 TORQUE WRENCHES

• КЛЮЧИ ДИНАМОМЕТРИЧЕСКИЕ • DREHMOMENTSCHLÜSSEL

PROLINE HD®

48 CrV 6140



• Calibration certificate inside • Delivered in plastic box

Code	Square	Range (Nm)	Length (mm)	
66800	1/4"	5-25	300	6
66801	3/8"	20-100	381	6
66802	1/2"	20-100	381	6
66803	1/2"	40-200	481	6
66804	1/2"	60-340	584	4
66805	3/4"	150-750	1210	1

### 2 TORQUE WRENCH

• КЛЮЧ ДИНАМОМЕТРИЧЕСКИЙ • DREHMOMENTSCHLÜSSEL

PROLINE HD®



x12 48 CrV 6140

• Calibration certificate inside • Delivered in plastic box  
• 13 mm, 14 mm, 15 mm, 17 mm, 19 mm, 22 mm, 24 mm, 27 mm, 30 mm, 32 mm

Code	Square	Range (Nm)	Length (mm)	
66812	1/2"	40-200	472	4

### 3 DIGITAL TORQUE WRENCH

• ЭЛЕКТРОННЫЙ ДИНАМОМЕТРИЧЕСКИЙ КЛЮЧ • DIGITALER DREHMOMENTSCHLÜSSEL

PROLINE HD®



36 CrV 3 x AAA 3 x 1,5V d.c. CE

• Calibration certificate inside • Allows angles to be measured • Additional functions (storing results, setting an angle, tracking torque, backlighting for the result, light and sound signaling)  
• Delivered in plastic box

Code	Square	Range (Nm)	Length (mm)	
66813	1/2"	40-200	530	3/6

### 4 TORQUE SCREWDRIVER

• ОТВЕРТКА ДИНАМОМЕТРИЧЕСКАЯ • DREHMOMENT-SCHRAUBENDREHER

PROLINE HD®

CrV



• Calibration certificate inside

Code	Hex	Range (Nm)	Length (mm)	
66814	1/4"	1-6	195	30

### 5 TORQUE WRENCHES

• КЛЮЧИ ДИНАМОМЕТРИЧЕСКИЕ • DREHMOMENTSCHLÜSSEL



CrV

• Calibration certificate inside • Delivered in plastic box

Code	Square	Range (Nm)	Length (mm)	
66700	3/8"	20-110	404	12
66701	1/2"	40 - 210	460	12
66702	1/2"	50 - 350	553	12

### 6 TORQUE MULTIPLIER

• УСИЛИТЕЛЬ КРУТЯЩЕГО МОМЕНТА • DREHMOMENTVERSTÄRKER



MAX 4800 Nm 1:64 32 mm 33 mm CrV

• Delivered in plastic box

Code	Square	Length (mm)	
46861	1"	315	3

### 7 TORQUE MULTIPLIER

• УСИЛИТЕЛЬ КРУТЯЩЕГО МОМЕНТА • DREHMOMENTVERSTÄRKER



MAX 6800 Nm 1:64 27 mm 30 mm 32 mm 33 mm CrV

• Delivered in plastic box

Code	Square	Length (mm)	
46862	1"	345	3

### 8 TORQUE SETTING ANGULAR GAUGE

• УГЛОМЕР ДЛЯ ДИНАМОМЕТРИЧЕСКОГО КЛЮЧА • DREHMOMENTEINSTELLUNG WINKELMESSGERÄT



1/2" 360°

Code	Size (mm)	Range		
66510	1/2"	360°	x	12/48

PROLINE

LANITI PRO

MEGA

JUCO

OTHER BRANDS

ERDI

KLINGSPOR

EXPRESS

ACTION CAN

TRYTON

VULCAN

### 1 DIESEL INJECTOR SOCKET SET

- НАСАДКИ ДЛЯ ФОРСУНОК ДИЗЕЛЬНЫХ ДВИГАТЕЛЕЙ – НАБОР
- DIESEL-EINSPRITZDÜSEN-STECKSCHLÜSSEL-SET



**x6 1/2" CrV**

- The set includes 12-angle bits:
  - ⊗ ⊞ ⊕ 1/2" x 27 mm x 78 mm
  - ⊗ ⊞ ⊕ 1/2" x 22 mm x 78 mm
  - ⊗ ⊞ ⊕ 1/2" x 28 mm x 78 mm
  - ⊗ ⊞ ⊕ 1/2" x 21 mm x 90 mm
- The set includes 6-angle bits:
  - ⊗ ⊞ ⊕ 1/2" x 22 mm x 110 mm
  - ⊗ ⊞ ⊕ 1/2" x 28 mm x 83 mm

Code	Quantity (pcs)	
46843	6	12

### 3 DIESEL INJECTOR TOOTHMED SOCKET SET

- КЛЮЧИ ДЛЯ ФОРСУНОК ДИЗЕЛЬНЫХ ДВИГАТЕЛЕЙ – НАБОР • DIESEL-EINSPRITZVENTIL ZAHN-STECKSCHLÜSSEL-SET



**x4 1/2" H32 CrV**

- The set includes:
  - ⊗ ⊞ ⊕ 1/2" x 72 mm x 4 teeth
  - ⊗ ⊞ ⊕ 1/2" x 120 mm x 3 teeth
  - ⊗ ⊞ ⊕ H32 x 70 mm x 4 teeth (M14 x 1.5 mm)
  - ⊗ ⊞ ⊕ H32 x 120 mm x 4 teeth

Code	Quantity (pcs)	
46845	4	20

### 2 OXYGEN SENSORS AND FUEL INJECTOR SOCKET SET

- НАБОР НАСАДОК ДЛЯ ЛЯМБДЫ-ЗОНДА И ФОРСУНОК • SAUERSTOFFSENSOR- UND KRAFTSTOFFEIN-SPRITZDÜSEN-STECKSCHLÜSSEL-SET



**x7 1/2" 3/8" CrV CrMo SCM-440**

- The set includes 12-angle bits:
  - ⊗ ⊞ ⊕ 1/2" x 27 mm x 78 mm
- The set includes 6-angle bits:
  - ⊗ ⊞ ⊕ 1/2" x 29 mm x 90 mm
  - ⊗ ⊞ ⊕ 1/2" x 22 mm x 50 mm
  - ⊗ ⊞ ⊕ 3/8" x 22 mm x 90 mm
  - ⊗ ⊞ ⊕ 3/8" x 22 mm x 80 mm
  - ⊗ ⊞ ⊕ 3/8" x 27 mm x 74 mm
  - ⊗ ⊞ ⊕ 3/8" x 22 mm x 30 mm

Code	Quantity (pcs)	
46844	7	10

### 4 OXYGEN SENSOR SOCKET SET

- ТОРЦЕВЫЕ КЛЮЧИ ДЛЯ ЛЯМБДА-ЗОНДА – НАБОР • SAUERSTOFFSENSOR-STECKSCHLÜSSEL-SET



**x3 1/2" 3/8" CrV CrMo SCM-440**

- The set includes 6-angle bits:
  - ⊗ ⊞ ⊕ 3/8" x 22mm x 80 mm
  - ⊗ ⊞ ⊕ 1/2" x 22mm x 50 mm
  - ⊗ ⊞ ⊕ 3/8" x 22mm x 30 mm

Code	Quantity (pcs)	
46846	3	20

### 1 INJECTOR PULLER WITH SLIDE HAMMER

• СЪЕМНИК ИНЕРЦИОННЫЙ ДЛЯ ФОРСУНОК • EINSPRITZDÜSEN-ZIEHER MIT GLEITHAMMER

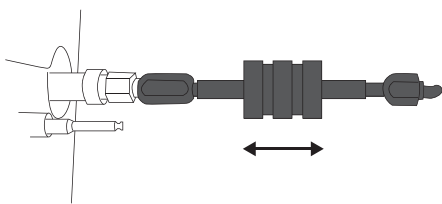

**M8 M12 M14 CrV**

• For installing injectors by BOSCH and LUCAS in Diesel engines • The set includes adapters M8, M12, M14

Code	Length (mm)	Box
46847	220	20

### 3 DEEP IMPACT SOCKET FOR ALLOY WHEELS

• УДАРНЫЕ ТОРЦЕВЫЕ ГОЛОВКИ ДЛЯ АЛЮМИНИЕВЫХ ДИСКОВ • SCHLAG-STECKSCHLÜSSEL FÜR LEICHTMETALLRÄDER



**1/2" CrMo SCM-440 PRO DRIVE**

• 17 - Ø ext. 26 mm • 19 - Ø ext. 28 mm  
• 21 - Ø ext. 30 mm • 22 - Ø ext. 32 mm

Code	Range (mm)	Square	Box
29095	17	1/2"	25/50
29096	19	1/2"	25/50
29097	21	1/2"	25/50
29098	22	1/2"	25/50

### 4 LEVER GREASE GUN

• ШПРИЦ - МАСЛЕНКА РУЧНАЯ • HANDFETTPRESSE MIT MUNDSTÜCKSATZ



**300 mm max 70MPa 500 cm³**

• Aluminium head • Structure enabling to load grease in two ways • Work pressure 31 MPa • Two dispensers: flexible (300 mm) and rigid (160 mm) • 4-jaw grease gun tips

Code	Capacity (cm³)	Box
42506	500	10

### 5 HAND GREASE GUN

• МАСЛЕНКА РУЧНАЯ • HANDFETTPRESSE



**220 mm 100 cm³**

• Useful for gardening, recreational equipment, cars, motorcycles etc.

Code	Capacity (cm³)	Box
42500	100	12/36

### 6 OIL SUCTION GUN

• ШПРИЦ - МАСЛЕНКА РУЧНАЯ • ÖLABSAUGER



**300 mm 500 cm³**

• Flexible dispenser Ø10 mm (260 mm)

Code	Capacity (cm³)	Box
42507	500	20

### 2 DEEP IMPACT SOCKET SET FOR ALLOY WHEELS

• НАБОР УДАРНЫХ ТОРЦЕВЫХ ГОЛОВОК ДЛЯ АЛЮМИНИЕВЫХ ДИСКОВ • SCHLAG-FELGENSTECKSCHLÜSSELSÄTZE

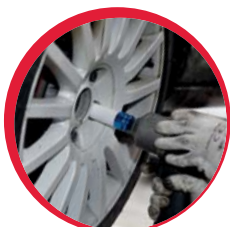

**x3 1/2" CrMo SCM-440 PRO DRIVE**

• 17 - Ø outer 26 mm • 19 - Ø outer 29 mm  
• 21 - Ø outer 31 mm • Delivered in plastic box

Code	Square	Range (mm)	Quantity (pcs)	Box
29080	1/2"	17 - 21	3	20



PROLINE

LAHTI PRO

MEGA

JUCO

OTHER BRANDS

ERDI

KUNGSFOR

EXPRESS

ACTION CAN

TRAYTON

VULCAN

**1 MAGNETIC BOWL**  
• ЛОТОК МАГНИТНЫЙ • MAGNETSCHÜSSEL



- Rubber bowl base protects the surface from scratching
- Can be used for storing metal objects, e.g. bolts, nails, rivets, staples

Code	Diameter (mm)		
46939	108		50

**2 MAGNETIC BOWL**  
• ЛОТОК МАГНИТНЫЙ • MAGNETSCHÜSSEL



- Rubber bowl base protects the surface from scratching
- Can be used for storing metal objects, e.g. bolts, nails, rivets, staples

Code	Diameter (mm)		
46949	150	x	12/36

**3 MAGNETIC BOWL**  
• ЛОТОК МАГНИТНЫЙ • MAGNETSCHÜSSEL



- Rubber bowl base protects the surface from scratching
- Can be used for storing metal objects, e.g. bolts, nails, rivets, staples

Code	Size (mm)		
46959	240 x 140	x	6/24

**4 TELESCOPIC MAGNETIC PICK UP TOOL**  
• МАГНИТНЫЙ ТЕЛЕСКОПИЧЕСКИЙ ДЕРЖАТЕЛЬ  
• MAGNETISCHES TELESKOP-AUFNAHMEWERKZEUG



max 22kg

Code	Length (mm)		
46971	590 - 990	x	12/24

**5 TELESCOPIC MAGNETIC PICK UP TOOL**  
• МАГНИТНЫЙ ТЕЛЕСКОПИЧЕСКИЙ ДЕРЖАТЕЛЬ  
• MAGNETISCHES TELESKOP-AUFNAHMEWERKZEUG

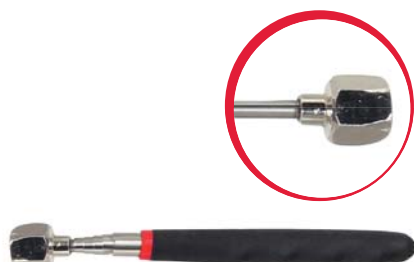

max 6.8kg

Code	Length (mm)		
46972	180 - 770	x	20/120

**6 LED TELESCOPIC MAGNETIC PICK UP TOOL**  
• МАГНИТНЫЙ ТЕЛЕСКОПИЧЕСКИЙ ДЕРЖАТЕЛЬ СО СВЕТОДИОДНОЙ ПОДСВЕТКОЙ  
• MAGNETISCHES LED-TELESKOP-AUFNAHMEWERKZEUG



max 3.6kg

LED



- Powered by three LR44 batteries

Code	Length (mm)		
46973	190 - 800	x	25/100

**7 TELESCOPIC INSPECTION MIRROR**  
• ТЕЛЕСКОПИЧЕСКОЕ ИНСПЕКЦИОННОЕ ЗЕРКАЛО  
• TELESKOP-INSPEKTIONSSPIEGEL



Ø 50mm

Code	Length (mm)		
46974	245 - 710	x	25/100

**8 LED TELESCOPIC INSPECTION MIRROR**  
• ТЕЛЕСКОПИЧЕСКОЕ ИНСПЕКЦИОННОЕ ЗЕРКАЛО СО СВЕТОДИОДНОЙ ПОДСВЕТКОЙ  
• LED-TELESKOP-INSPEKTIONS-SPIEGEL



50x80 mm

LED



- Powered by two LR44 batteries

Code	Length (mm)		
46975	285 - 875	x	10/100

**9 TELESCOPIC PICK UP TOOL AND MIRROR SET**  
• ИНСПЕКЦИОННЫЙ НАБОР: МАГНИТНЫЙ НАКОНЕЧНИК И ЗЕРКАЛО  
• TELESKOP-AUFNAHMEWERKZEUG UND SPIEGEL-SET



- Telescopic structure offers the adjustable length of devices: pick-up tool 160 - 645 mm; mirror 250 - 925 mm, diameter 57 mm
- Foldable plastic case

Code	Quantity (pcs)		
46979	4	x	10/40

**1 MAGNETIC TOOL HOLDER**

• МАГНИТНАЯ ПЛАНКА ДЛЯ ИНСТРУМЕНТА • MAGNETLEISTE FÜR WERKZEUG



Code	Length (mm)		
46969	500	x	12/24

**2 STRAIGHT TWEEZER**

• ПИЦЦЕТ • GERADE PINZETTE



• Anti-static and acid-resistant coating

Code	Length (mm)		
46981	140	x	40/800

**3 BENT TWEEZER**

• ПИЦЦЕТ • GEBUGENE PINZETTE



• Anti-static and acid-resistant coating

Code	Length (mm)		
46982	115	x	40/800

**4 SEAL PULLER**

• СЪЕМНИК УПЛОТНИТЕЛЬНЫХ КОЛЕЦ И СОЕДИНЕНИЙ • DICHTUNGSABZIEHER



• For dismounting inner rubber and metal seals Ø 65 mm

Code	Diameter (mm)		
46850	65	x	12/48

**5 OIL FILTER WRENCHES**

• КЛЮЧ ДЛЯ МАСЛЯНОГО ФИЛЬТРА • SCHLÜSSEL FÜR ÖLFILTER



• For oil filter replacement • Moveable handle

Code	Diameter (mm)		
46882	60 - 73	x	12/48
46883	73 - 85	x	12/48
46884	85 - 95	x	12/48
46885	95 - 111	x	12/48

**6 CUP TYPE OIL FILTER WRENCH SET**

• ТОРЦЕВЫЕ КЛЮЧИ ДЛЯ МАСЛЯНОГО ФИЛЬТРА – НАБОР • TASSENÖLFILTER-SCHLÜSSELSET

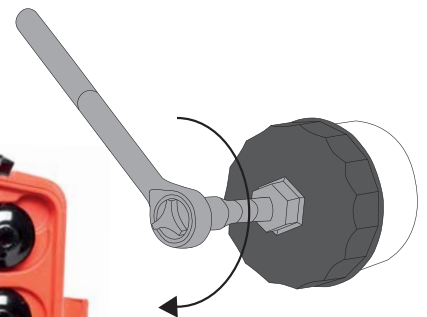

**x30 1/2" 3/8"**

• Set of spigot spanners made from Cr-Mb steel • Designed for replacement of metal oil filters in passenger and delivery vehicles • The set includes a three-branch spanner and an adapter 3/8"-1/2"

Code	Square	Quantity (pcs)	
46887	3/8"	30	3

PROLINE

LANITI PRO

MEGA

JUCO

OTHER BRANDS

ERDI

KLINGSPOR

EXPRESS

ACTION CAN

TRAYTON

VULCAN

**1 THREE JAW OIL FILTER WRENCH**

• Ключ для масляного фильтра • DREIACKEN-ÖLFILTERSCHLÜSSEL



1/2" 3/8" CrV

• A three-branch spanner for replacing oil filters

Code	Range (mm)	
46886	65 - 114	5/20

**4 BEARING SEPARATOR 30-50MM**

• СЪЕМНИК ПОДШИПНИКОВ СТЯЖНОЙ (СЕГМЕНТНЫЙ) 30-50 ММ • LAGERABSCHIEDER 30-50 MM



CrV

• For removing bearings, gears and other tight-fitting components

Code	Range (mm)	
46851	30 - 50	20

**5 DISC BREAK SPREADER**

• РАСПОРКА ТОРМОЗНЫХ ДИСКОВ • SCHEIBENBREMSVERTEILER

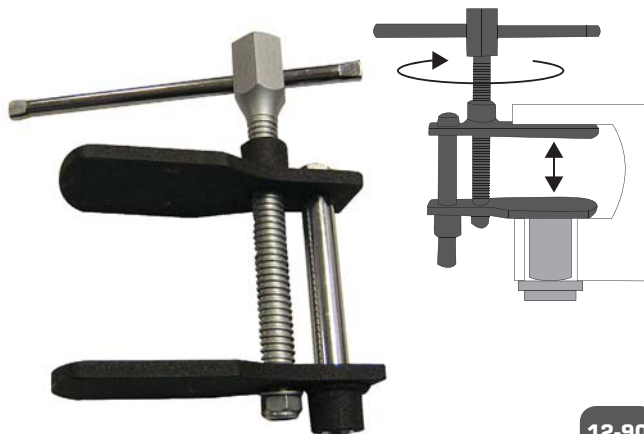

12-90 mm

Code	Range (mm)		
46874	12 - 90	x	20

**3 UPHOLSTERY PULLERS SET**

• НАБОР СЪЕМНИКОВ КРЕПЕЖА ОБИВКИ • POLSTERABZIEHER-SET

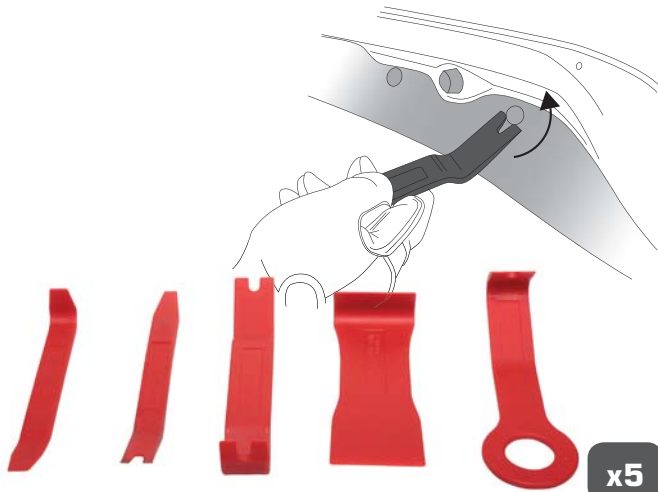

x5

• Tools facilitating installation of vehicle interior components • Designed for dismantling profiles, clips and upholstery in vehicles • Made from a hardened nylon, making them highly durable and flexible

Code	Quantity (pcs)	
46894	5	6/24

**6 SPEEDY BRAKE COMPRESSOR**

• УСТРОЙСТВО ДЛЯ ВЫДАВЛИВАНИЯ ДЛЯ ТОРМОЗНЫХ ПОРШНЕЙ • SCHNELLER BREMSKOMPRESSOR

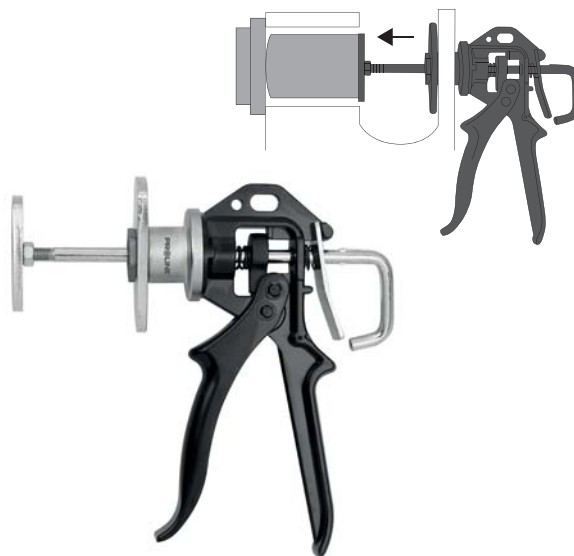

• Designed for quick pushing of brake pistons

Code	Range (mm)	
46879	15-90	16

**1 SPRING PULLER**

• СЪЕМНИКИ ПРУЖИН • FEDER-ZIEHER



**x2** **1/2"** **300 mm**

Code	Length (mm)	
46892	300	10

**2 INTERNAL GEAR PULLER**

• СЪЕМНИК ПОДШИПНИКОВ, ВНУТРЕННИЙ • INNENZAHNRADABZIEHER



Code	Range (mm)	
46866	14 - 38	20

**3 EXTERNAL GEAR PULLER**

• СЪЕМНИК ПОДШИПНИКОВ, ВНЕШНИЙ • AUSSERER ZAHNRADABZIEHER



Code	Range (mm)	
46867	24-55	6/24

**4 INTERNAL AND EXTERNAL BEARING PULLER SET**

• СЪЕМНИК ПОДШИПНИКОВ ИНЕРЦИОННЫЙ • INNEN- UND AUSSENLAGERABZIEHER-SET

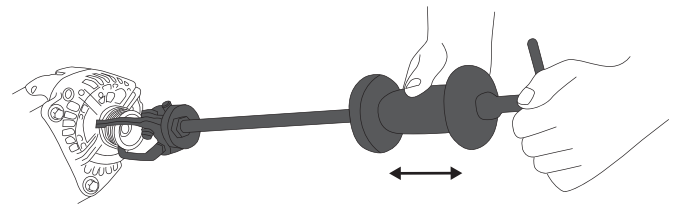

**x5**

- A specialist tool for dismounting bearings • The set includes an impact puller and four replaceable tips (2 inner removers, 2 outer removers) - inner; two-branched

Code	Quantity (pcs)	
46868	5	2

**5 WHEEL HUB SLIDE HAMMER PULLER SET**

• СЪЕМНИК ИНЕРЦИОННЫЙ ДЛЯ СТУПИЦ • RADNABEN-GLEITHAMMER-ABZIEHER-SET

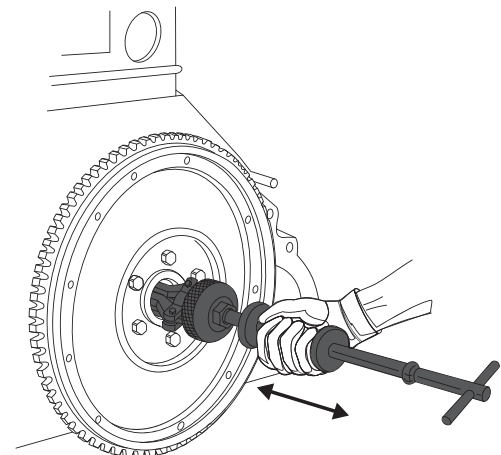

**x26**

- A specialist tool for dismounting hubs
- The set includes an impact puller and two changeable heads

Code	Quantity (pcs)	
46869	26	2

PROLINE

LAHTI PRO

MEGA

JUCO

OTHER BRANDS

ERDI

KUNGSFOR

EXPRESS

ACTION CAN

TRYTON

VULCAN

**1 BALL JOINT SEPARATOR**

• ДВУХПОЗИЦИОННЫЙ СЪЕМНИК ШАРОВЫХ ОПОР • KUGELGELENKTRENNER



• For disassembly of ball pins

Code	Diameter (mm)	
46876	17	20

**2 BALL JOINT SEPARATOR**

• СЪЕМНИК ШАРОВЫХ ОПОР • KUGELGELENKTRENNER



• For removing ball pins

Code	Diameter (mm)		
46871	19	x	20

**3 BALL JOINT SEPARATOR**

• ДВУХПОЗИЦИОННЫЙ СЪЕМНИК ШАРОВЫХ ОПОР • KUGELGELENKTRENNER



• For removal of ball pins

Code	Diameter (mm)	
46877	19	20

**4 TWO STAGE BALL JOINT SEPARATOR**

• ДВУХПОЗИЦИОННЫЙ СЪЕМНИК ШАРОВЫХ ОПОР • ZWEISTUFIGER KUGELGELENKTRENNER



• For removing ball pins

Code	Diameter (mm)		
46870	22	x	20

**5 BALL JOINT SEPARATOR**

• СЪЕМНИК ШАРНИРОВ • KUGELGELENKTRENNER

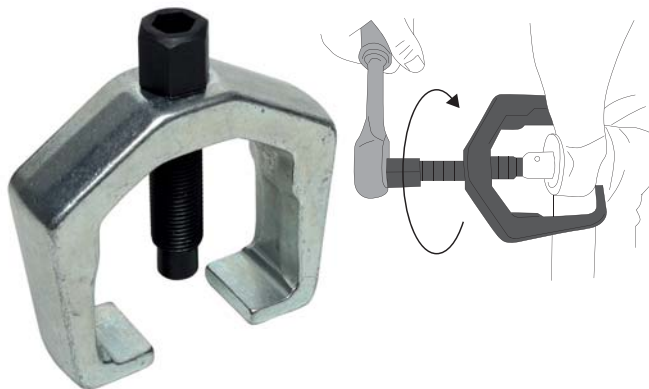

• For removal of joints

Code	Diameter (mm)	
46878	33	20

**6 PISTON RING COMPRESSOR**

• ЗАЖИМЫ ДЛЯ ПОРШНЕВЫХ КОЛЕЦ • KOLBENRINGSpanNER



• For removing pistons in the engine body

Code	Diameter (mm)	Height (mm)		
46863	53 - 125	75	x	30/60
46864	90 - 175	100	x	30/60
46865	90 - 175	150	x	20/40

**7 SMALL MOUTH PULL CLAMP**

• ЗАЖИМ ЖЕСТЯНЩИКА • KLEINE MUND-ZUG-ZANGE

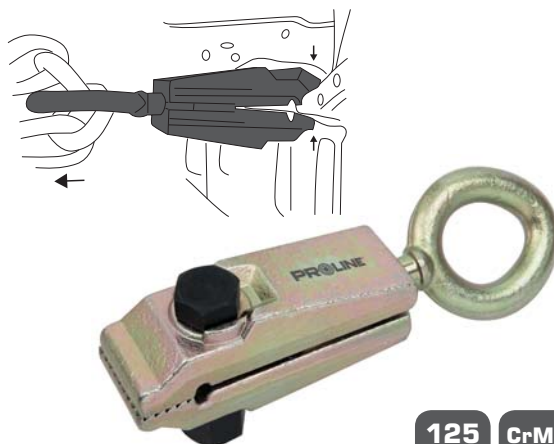

• Forged • Self-clamping • Clamping force 5 tonnes • Notched jaws ensuring stronger gripping force • Designation: specialist tinsmithing service

Code	Pressure value (t)	
46895	5	6



**1 EXHAUST CHAIN CUTTER**

• ПРИСОБОБЛЕНИЕ ДЛЯ РЕЗКИ ВЫХЛОПНЫХ ТРУБ 20-75 MM • AUSPUFFKETTENSCHNEIDER



• For cutting exhaust pipes in places difficult to reach

Code	Range (mm)	
46849	20-75	6/36

**2 4 PC STUD EXTRACTOR SET**

• НАБОР 4 ШТ. ШПИЛЬКОВЕРТОВ • 4 STK. BOLZEN AUSZIEHER SET



x4 1/2" CrV

• For unscrewing pins or broken bolts

Code	Size		
46888	M6, M8, M10, M12	x	20

**3 RADIO REMOVAL KIT**

• НАБОР ДЛЯ ДЕМОНТАЖА РАДИОПРИЁМНИКОВ • RADIO-AUSBAU-SET

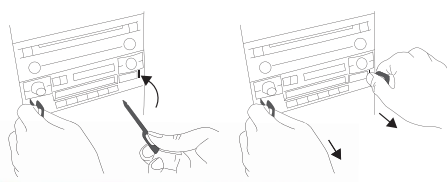

x52

• For removal of car radio receivers both OEM and universal (such as SONY, BLAUPUNKT, PANASONIC, KENWOOD) • Set in a case with the purpose of every element embossed on it

Code	Quantity (pcs)	
46854	52	5

**4 SPECIAL TWIN ARM PULLER AND SEPARATOR**

• УНИВЕРСАЛЬНЫЙ СЪЕМНИК С СЕПАРАТОРОМ • SPEZIELLER DOPPELARMABZIEHER UND ABSCHIEDER



x12

• For removing bearings, gears

Code	Separator (mm)	Puller (mm)	
46858	10 - 30	10 - 60	30

**5 3 PC. TWIN ARM PULLER SET**

• НАБОР 3 ШТ. УНИВЕРСАЛЬНЫХ ДВУХЗАХВАТНЫХ СЪЕМНИКОВ • 3-TEILIGES DOPPELARMABZIEHER-SET



98  
212  
261  
MM

35-135  
mm

CrV

• For removing bearings, gears

Code	Diameter (mm)	Length (mm)	
46859	35 - 135	120 - 280	4

**6 5 PC. BALL JOINT SEPARATOR SET**

• НАБОР ДЛЯ СНЯТИЯ ШАРОВЫХ ШАРНИРОВ, РУЛЕВЫХ ТЯГ И РУЛЕВЫХ СОШЕК 5 ШТ. • 5-TEILIGES KUGELGELENK-ABSCHIEDER-SET



x5

8mm

24mm

123mm

CrV

• For removing steering rods • Replaceable handles for slogging with a hammer or air wrenches

Code	Separator (mm)	
46860	11/16", 15/16", 1 1/8"	10

PROLINE

LANITI PRO

MEGA

JUCO

OTHER BRANDS

ERDI

KLINGSPOR

EXPRESS

ACTION CAN

TRYTON

VULCAN

**1 BRAKE PISTON WIND BACK TOOL SET**

• НАБОР ДЛЯ РАЗВОДА ПОРШНЕЙ ТОРМОЗНЫХ ЦИЛИНДРОВ • BREMSKOLBEN RÜCKDREH-WERKZEUGSET



x12

• Universal set for various vehicle types

Code	Quantity (pcs)	
46880	12	10

**2 BRAKE PISTON WIND BACK TOOL SET**

• НАБОР ДЛЯ РАЗВОДА ПОРШНЕЙ ТОРМОЗНЫХ ЦИЛИНДРОВ • BREMSKOLBEN RÜCKDREH-WERKZEUGSET



x18

• Universal set for various types of cars

Code	Quantity (pcs)	
46881	18	10

**3 OIL DRAIN PLUG SET**

• НАБОР КЛЮЧЕЙ ДЛЯ СЛИВНОЙ ПРОБКИ МАСЛЯНОГО ФИЛЬТРА • ÖLABLASSSCHRAUBEN-SET



x18 3/8" CrV

• 3/8" • 3/8" 8, 9, 10, 12, 14, 17 mm • 3/8" 7, 8, 10, 11, 12, 13, 14 mm, 5/16", 3/8" • 3/8" 10 mm

Code	Quantity (pcs)	
46875	18	15

**4 AUTO WINDSCREEN REMOVAL TOOL SET**

• НАБОР ДЛЯ ДЕМОНТАЖА АВТОСТЕКЛА • AUTO WINDSCHUTZSCHEIBEN-ENTFERNUNGSWERKZEUG-SET



x7

• For cutting damaged glued vehicle panes • The set includes: pane cutting rope, rope handles, tool for rope pulling, clip remover, pane knife, seal knife

Code	Quantity (pcs)	
46853	7	5/10

**5 OIL SUMP PLUG REPAIR SET**

• РЕМОНТНЫЙ НАБОР ПРОБОК ДЛЯ МАСЛЯНОГО КАРТЕРА • ÖLSUMPFSCRAUBE REPARATURSATZ



M13 x 1	M13 x 5	13 mm x 10	<b>M13</b>
M15 x 1	M15 x 5	15 mm x 10	<b>M15</b> <b>M17</b>
M17 x 1	M17 x 5	17 mm x 10	<b>M20</b> <b>x64</b>
M20 x 1	M20 x 5	20 mm x 10	

• For repairing leaky oil drains • Includes 4 sizes: M13, M15, M17, and M20 • For each size, there is 1 screw tap, 5 plugs, and 10 washers in the set

Code	Quantity (pcs)	
46889	64	5

### 1 ALTERNATOR PULLEY TOOL SET

• КЛЮЧИ ДЛЯ ГЕНЕРАТОРОВ ПЕРЕМЕННОГО ТОКА – НАБОР • GENERATOR-RIEMENRAD-WERKZEUGSATZ



**x13 CrV HRC 55±2**

- Spanners for dismounting alternators by Magnetti Marelli and Bosch in such vehicles as VAG, PSA, BMW, FIAT, MERCEDES, VOLVO and many others.
- 1/2" SPLINE M10
- 1/2" TORX T50
- HEX H10 TORX T40, T50
- HEX H10 SPLINE M8, M10
- HEX H10 HEX H8, H10
- HEX H15 33T
- HEX H22 33T
- HEX H22 HEX H22
- HEX H17 Ø 35
- 1/2" HEX H10

Code	Quantity (pcs)	
46848	13	10

### 2 DIESEL FLOW & ADAPTOR SET

• КОМПЛЕКТ ДЛЯ ДИАГНОСТИКИ ФОРСУНОК ВПРЫСКА ТОПЛИВА • DIESEL FLUSS- UND ADAPTER-SATZ

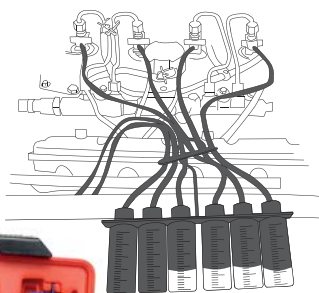

**x31**

- For Diesel engine injection diagnosis (COMMON RAIL) using the overflow method • Diagnose up to 6 injectors simultaneously • For the following brands of injectors: BOSCH, SIEMENS, DENSO, and DELPHI

Code	Quantity (pcs)	
46852	31	6

### 3 DIESEL ENGINE COMPRESSION TEST SET

• ИЗМЕРИТЕЛЬ ДАВЛЕНИЯ СЖАТИЯ ДЛЯ ДИЗЕЛЬНЫХ ДВИГАТЕЛЕЙ • DRUCKPRÜFGERÄT FÜR DIESELMOTOREN

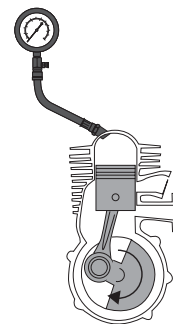

**x16 0-70 bar 0-1000 psi**

- For measuring Diesel engine compression • Includes adapters for glow plug or injector slots

Code	Pressure (bar)	
46897	0-70	5

### 4 OIL PRESSURE TEST SET

• ИЗМЕРИТЕЛЬ ДАВЛЕНИЯ МАСЛА • ÖLDRUCKPRÜFGERÄT



**x12 0-35 bar 0-500 psi**

- For most types of engines both in cars and light commercial vehicles
- Clear, double scale (0-35 bar / 0-500 psi) • 1650 mm hose

Code	Pressure (bar)	
46898	0-35	10

### 5 FUEL PRESSURE TEST SET

• ИЗМЕРИТЕЛЬ ДАВЛЕНИЯ ТОПЛИВА • KRAFTSTOFFDRUCK-PRÜFGERÄT



**x9 0-70 cmHg 0-0,7 bar 0-10 psig**

- For measuring positive and negative pressure in car and motorcycle engines • For diagnosing problems with fuel pumps, valves, and ignition
- Manometer 0-10 psig (0-0.7 bar) • Vacuum gauge 0-70 cmHg
- Includes a 14/ 18 mm adapter and a 600 mm hose

Code	Pressure (bar)	
46899	0-0,7	10

PROLINE

LAHTI PRO

MEGA

JUCO

OTHER BRANDS

ERDI

KUNGSFOR

EXPRESS

ACTION CAN

TRAYTON

VULCAN

**1 HYDRAULIC BOTTLE JACKS**

• ГИДРАВЛИЧЕСКИЙ БУТЫЛОЧНЫЙ ДОМКРАТ • HYDRAULISCHE SÄULEN-HEBEVÜHNE



Code	Load-carrying capacity (t)	Range (mm)	Weight netto (kg)	
46802	2	181 - 345	2.5	6
46803	3	194 - 374	3.2	6
46805	5	216 - 413	4.3	4
46808	8	230 - 457	5.5	4
46810	10	230 - 460	6.2	4
46812	12	230 - 465	7.2	3
46815	15	230 - 462	8.1	2
46820	20	242 - 452	10.5	2

**2 HYDRAULIC FLOOR JACK**

• ГИДРАВЛИЧЕСКИЙ ПОДКАТНОЙ ДОМКРАТ • HYDRAULISCHE HEBEVÜHNE



**2t** **9,8** max 350 mm min 130 mm 495 mm x 220 mm x 135 mm

Code	Size (mm)	Load-carrying capacity (t)	
46922	495 x 220 x 135	2	1

**3 LOW PROFILE HYDRAULIC FLOOR JACK**

• ГИДРАВЛИЧЕСКИЙ НИЗКОПРОФИЛЬНЫЙ ПОДКАТНОЙ ДОМКРАТ • HYDRAULISCHE HEBEVÜHNE MIT NIEDRIGEM PROFIL



**2t** **14,1** max 359 mm min 89 mm 556 mm x 234 mm x 153 mm 340°

• Its low profile makes it possible to lift also low-slung vehicles, sports cars etc.

Code	Size (mm)	Load-carrying capacity (t)	
46921	556 x 234 x 153	2	1

**4 QUICK-LIFT HYDRAULIC FLOOR JACK**

• ГИДРАВЛИЧЕСКИЙ ПОДКАТНОЙ ДОМКРАТ С ФУНКЦИЕЙ БЫСТРОГО ПОДЪЕМА • HYDRAULISCHE HEBEVÜHNE MIT SCHNELL-HEBE-FUNKTION



**2.5t** **19,6** max 435 mm min 150 mm max 530 mm min 245 mm 632 mm x 242 mm x 150 mm



- Lifting range: without extension: 157 - 427 mm, with extension: 250 - 520 mm
- Fast-lifting function

Code	Size (mm)	Load-carrying capacity (t)	
46923	632 x 242 x 150	2.5	1

**5 LOW PROFILE HYDRAULIC FLOOR JACK**

• ГИДРАВЛИЧЕСКИЙ НИЗКОПРОФИЛЬНЫЙ ПОДКАТНОЙ ДОМКРАТ • HYDRAULISCHE HEBEVÜHNE MIT NIEDRIGEM PROFIL



**2.5t** **34,8** max 497 mm min 89 mm 640 mm x 346 mm x 180 mm

• Its low profile makes it possible to lift also low-slung vehicles, sports cars etc.

Code	Size (mm)	Load-carrying capacity (t)	
46926	640 x 346 x 180	2.5	1

**1 QUICK-LIFT HYDRAULIC FLOOR JACK**

• ГИДРАВЛИЧЕСКИЙ ПОДКАТНОЙ ДОМКРАТ С ФУНКЦИЕЙ БЫСТРОГО ПОДЪЁМА • HYDRAULISCHE HEWEBÜHNE MIT SCHNELL-HEBE-FUNKTION



**3t** 37,2 max 500 mm min 145 mm 685 mm x 346 mm x 180 mm

• Fast-lifting function

Code	Size (mm)	Load-carrying capacity (t)	
46927	685 x 346 x 180	3	1

**2 HYDRAULIC FLOOR JACK**

• ГИДРАВЛИЧЕСКИЙ ПОДКАТНОЙ ДОМКРАТ • HYDRAULISCHE HEWEBÜHNE



**3t** 36,5 max 320 mm min 140 mm 675 mm x 346 mm x 185 mm

Code	Size (mm)	Load-carrying capacity (t)	
46925	675 x 346 x 185	3	1

**3 MOTORCYCLE HYDRAULIC JACK**

• ДОМКРАТ ПОДКАТНОЙ ДЛЯ МОТОЦИКЛОВ, КВАДРОЦИКЛОВ И МАЛОТОННАЖНОЙ ТЕХНИКИ • MOTORRADHEWEBÜHNE



**400kg** 34,2 max 420 mm min 140 mm 864 mm x 396 mm x 140 mm

Code	Size (mm)	Load-carrying capacity (kg)	
46950	864 x 396 x 140	400	1

**4 SCISSOR JACKS**

• ВИНТОВЫЕ РОМБИЧЕСКИЕ ДОМКРАТЫ • SCHERENHEBER



Code	Load-carrying capacity (t)	Range (mm)	Weight netto (kg)	
46911	1	88 - 370	2.3	5
46915	1.5	95 - 390	3.2	5

**5 PAIRS OF JACK STANDS**

• ПОДСТАВКИ ПОД АВТОМОБИЛЬ (ПАРЫ) • UNTERSTELLBÖCKE FÜR AUTOS (PAAREN)



• 10-step height adjustment

Code	Load-carrying capacity (t)	Range (mm)	Weight netto (kg)	
46912	2	265 - 418	5.5 (2szt.)	1
46913	3	280 - 420	7.8 (2szt.)	1
46914	6	382 - 600	13.1 (2szt.)	1



**6 HYDRAULIC BODY REPAIR SET**

• ГИДРАВЛИЧЕСКАЯ РАСПОРНАЯ СТОЙКА – НАБОР В ПЛАСТИКОВОМ КЕЙСЕ • HYDRAULISCHE STRECKER



Code	Expansion force (t)	Range (mm)	Net weight (kg)	
46928	4	270 - 390	16.5	1
46929	10	380 - 530	30.5	1

PROLINE  
LANITI PRO  
MEGA  
JUCO  
OTHER BRANDS  
ERDI  
KLINGSPOR  
EXPRESS  
ACTION CAN  
TRYTON  
VULCAN

**1 MECHANIC'S CREEPER**  
• РЕМОНТНЫЙ ПОДКАТНОЙ ЛЕЖАК • WERKSTATTROLLIEGE



6,0 kg  
930mm x 440mm x 105mm  
360° x 6

• Steel structure • Upholstered

Code	Size (mm)	Net weight (kg)	
46938	930 x 440 x 105	6	1

**2 MECHANIC'S CREEPER**  
• РЕМОНТНЫЙ ПОДКАТНОЙ ЛЕЖАК • WERKSTATTROLLIEGE



max 90kg  
5,8 kg  
1010mm x 475mm x 130mm  
360° x 6

• Upholstered head rest

Code	Size (mm)	Net weight (kg)	
46936	1010 x 475 x 130	5.8	1

**3 MECHANIC'S CREEPER WITH MAGNETIC PLATES**  
• РЕМОНТНЫЙ ПОДКАТНОЙ ЛЕЖАК С ДВУМЯ ВСТРОЕННЫМИ МАГНИТНЫМИ ЛОТКАМИ • WERKSTATTROLLIEGE MIT MAGNETTABLETTEN



max 90kg  
5,5 kg  
1010mm x 475mm x 130mm  
360° x 6

• Upholstered head rest • 2 magnetic trays

Code	Size (mm)	Weight netto (kg)	
46937	1010 x 475 x 130	5.5	1

**4 PNEUMATIC WORKSHOP SEAT**  
• РЕМОНТНОЕ КРУГЛОЕ СИДЕНЬЕ НА КОЛЕСАХ С МИКРОЛИФТОМ • ПНЕУМАТИЧЕСКИЙ WERKSTATTHOCKER



max 90kg  
380mm x 380mm x 575mm  
360° x 4

• Upholstered • Pneumatic height control

Code	Size (mm)	Net weight (kg)	
46940	380 x 380 x 575	5.7	1

**5 WORKSHOP SEAT**  
• РЕМОНТНОЕ ПРЯМОУГОЛЬНОЕ СИДЕНЬЕ С ПОЛКОЙ • WERKSTATTHOCKER



max 90kg  
360mm x 400mm x 340mm  
360° x 4

• Upholstered • Retractable drawer

Code	Size (mm)	Net weight (kg)	
46941	360 x 400 x 340	5	1

**6 BOOSTER CABLES**  
• КАБЕЛИ ДЛЯ ЗАПУСКА • BOOSTER-KABEL



Code	Wire cross-section (mm²)	Length (m)	Nominal start-up current (A)		
24750	8	2.5	200	x	10
24751	16	3.0	220	x	10
24752	25	3.5	350	x	6
24753	35	4.5	480	x	4

**7 CABLE PULLERS**  
• МОНТАЖНЫЙ РЫЧАЖНО-ТЯГОВЫЙ МЕХАНИЗМ (ЛЕБЕДКА РУЧНАЯ) • SEILWINDEN



Code	Load-carrying capacity (daN)	Rope length (m)	Rope diameter (mm)	Weight (kg)	
46710	1000	3	5	2.5	6
46713	1300	3	5	3.9	6
46715	1500	3	6	7.6	6



**1 INVERTER CHARGER**

• ИНВЕРТОРНОЕ ЗАРЯДНОЕ УСТРОЙСТВО • WECHSELRICHTER-LADEGERÄT



- Smart inverter-rectifier designed for charging all types of 12 V batteries with capacities from 2 to 60 AH, lead-acid, gel, MF (maintenance-free), CA (calcium), EFB and AGM • Charging current (A)
- Charging voltage (V)

Code	Charging current (A)	Charging voltage (V)	BOX	
46830	2A/1A	12V	x	16

**3 INVERTER CHARGER**

• ИНВЕРТОРНОЕ ЗАРЯДНОЕ УСТРОЙСТВО • WECHSELRICHTER-LADEGERÄT

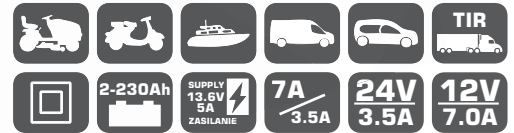

- Smart inverter-rectifier designed for charging all types of 12/24 V batteries with capacities from 2 to 230 AH, lead-acid, gel, MF (maintenance-free), CA (calcium), EFB and AGM • Charging current (A)
- Charging voltage (V)

Code	Charging current (A)	Charging voltage (V)	BOX	
46832	7A/3.5A	12/24V	x	8

**2 INVERTER CHARGER**

• ИНВЕРТОРНОЕ ЗАРЯДНОЕ УСТРОЙСТВО • WECHSELRICHTER-LADEGERÄT



- Smart inverter-rectifier designed for charging all types of 12 V batteries with capacities from 2 to 120 AH, lead-acid, gel, MF (maintenance-free), CA (calcium), EFB and AGM • Charging current (A)
- Charging voltage (V)

Code	Charging current (A)	Charging voltage (V)	BOX	
46831	3,5A/1A	12V	x	10

**4 INVERTER CHARGER WITH EMERGENCY START FUNCTION**

• ИНВЕРТОРНОЕ ЗАРЯДНОЕ УСТРОЙСТВО С ФУНКЦИЕЙ АВАРИЙНОГО ЗАПУСКА • WECHSELRICHTER-LADEGERÄT MIT NOTSTARTFUNKTION



- Smart inverter-rectifier with a Boost function, designed for charging all types of 12 V batteries with capacities from 2 to 60 AH, lead-acid, gel, MF (maintenance-free), CA (calcium), EFB and AGM • Additional 12 V DC power socket • Charging current (A) • Charging voltage (V)

Code	Charging current (A)	Charging voltage (V)	BOX	
46833	2A/6A/10A/15A	12V	x	8

**1 LED FLOODLIGHT**

• СВЕТОДИОДНЫЙ ПРОЖЕКТОР • LED-FLUTLICHT



- LED Floodlight 10W/ 30W/ 50W • Power supply: 220-240 V/AC
- IP65 • Modern look housing made of aluminium and PVC • Very effective heat dissipation in line with high efficiency • Compact size

Code	Power (W)	Light sources	Luminous flux (lm)	Box
66181	10	15 (SMD)	800	50
66183	30	45 (SMD)	2400	10
66185	50	75 (SMD)	4000	10

**3 PORTABLE LED LAMP**

• ПЕРЕНОСНАЯ СВЕТОДИОДНАЯ ЛАМПА • TRAGBARE LED-LAMPE



- Compact LED lamp with a stand and carrying handle • Power supply: 220-240 V • Power frequency: 50-60 Hz • Light source: SMD LEDs (45 pcs) • Light sources • Luminous flux

Code	Power (W)	Light sources	Luminous flux (lm)	Box
66188	30	45 (SMD)	2550	15

**2 LED FLOODLIGHT**

• СВЕТОДИОДНЫЙ ПРОЖЕКТОР • LED-FLUTLICHT

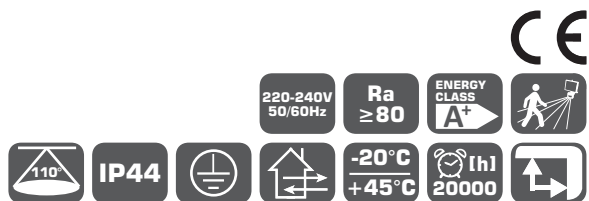

- LED Floodlight 10W/ 30W • IP44 • Power supply: 220-240 V/AC
- Modern look housing made of aluminium and PVC • Very effective heat dissipation in line with high efficiency • Compact size • Motion sensor (6m) • Adjustable working time after motion detection (3 to 300 sec.)

Code	Power (W)	Light sources	Luminous flux (lm)	Box
66182	10	15 (SMD)	800	40
66184	30	45 (SMD)	2400	10

**4 LED RECHARGEABLE LAMP**

• СВЕТОДИОДНЫЙ ПРОЖЕКТОР • WIEDERAUFLADBARE LED-LAMPE

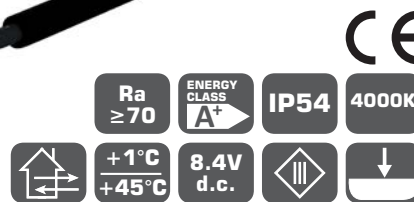

- LED rechargeable lamp 10W/ 20W • IP44 • Modern design housing
- Very compact - 360 degrees regulation • Two sets of light intensity (50% i 100%) • Charger included

Code	Power (W)	Light sources	Luminous flux (lm)	Battery (mAh)	Box
66186	10	20 (SMD)	600	2600	5
66187	20	36 (SMD)	1200	5200	5



### 1 DOUBLE HALOGEN LAMP STAND

• ЛАМПА ПЕРЕНОСНАЯ ГАЛОГЕННАЯ НА ШТАТИВЕ • EINSTELLBARE LAMPE AUF STATIV 2X500W PROLINE 2IN1



3 m  
 R7S J118 mm  
 IP44  
 230V 50Hz  
 MAX. 2x500W

- Double lamp with adjustable stand 2x500W
- Power supply: 220 ~ 240V/AC IP44 • Power frequency: 50-60Hz • High-pressure cast aluminium body • Powder-coated body and stand • High-quality aluminium reflector
- Tempered glass • Black / red • Halogen light source 2 x • Max: 500W 118 mm R7x • Stand adjustable in the range of: 85-182cm • Carrying handle • Can be mounted on the stand and directly on the ground • Adjustable light angle
- 3m electrical cord with a plug

Code	Power (W)	Box
66158	2 x 500	2

### 2 HIGH POWER LED TORCH

• ФОНАРЬ HIGH POWER LED • HOCHLEISTUNGS-LED-TASCHENLAMPE



HIGH POWER  
 LED 3W  
 AL  
 100% 50% FLASH  
 97g

- Designed for use in various weather conditions

Code	Length (mm)	Operating mode	Box
51019	120	100%, 50%, flash	x 20/60

### 3 LED USB RECHARGEABLE FLASHLIGHT

• АККУМУЛЯТОРНЫЙ СВЕТОДИОДНЫЙ ФОНАРИК USB • WIEDERAUFLADBARE USB-LED-TASCHENLAMPE



300 LUMEN  
 CREE XPG LED  
 3.7V d.c.  
 Li-Ion 2200 mAh  
 1x 18650  
 USB RECHARGEABLE LADOWANIE  
 100% 50% FLASH  
 ZOOM  
 AL AIRCRAFT GRADE  
 HIGH POWER

- Torch made of durable and resistant aerospace aluminum • Efficient CREE XPG high-power (300 lm) LED • ZOOM function
- Built-in USB port for charging
- LED indicating the battery's status during charging (red - charging, green - full battery)
- Replaceable battery, 18650 type (with a capacity of 2200 mAh) • Three operating modes (100%, 50%, FLASH) • Rubber seals for protection against water
- Included: USB cable, battery

Code	Operating mode	Box
51034	100%, 50%, FLASH	6/48

### 4 LED USB RECHARGEABLE FLASHLIGHT

• АККУМУЛЯТОРНЫЙ СВЕТОДИОДНЫЙ ФОНАРИК USB • WIEDERAUFLADBARE USB-LED-TASCHENLAMPE



800 LUMEN  
 CREE U2 LED  
 3.7V d.c.  
 Li-Ion 6000 mAh  
 2x 26650  
 USB RECHARGEABLE LADOWANIE  
 100% 50% FLASH  
 ZOOM  
 AL AIRCRAFT GRADE  
 HIGH POWER

- Torch made of durable and resistant aerospace aluminum • Efficient CREE U2 high-power (800 lm) LED • ZOOM function
- Built-in USB port for charging
- LED indicating the battery's status during charging (red - charging, green - full battery)
- Two replaceable batteries, 26650 type (each with a capacity of 3000 mAh) • Three operating modes (100%, 50%, FLASH) • Rubber seals for protection against water
- Included: USB cable, batteries

Code	Operating mode	Box
51035	100%, 50%, FLASH	6/36

### 5 LED USB RECHARGEABLE FLASHLIGHT

• АККУМУЛЯТОРНЫЙ СВЕТОДИОДНЫЙ ФОНАРИК USB • WIEDERAUFLADBARE USB-LED-TASCHENLAMPE



1500 LUMEN  
 3XCREE T6 LED  
 3.7V d.c.  
 Li-Ion 6000 mAh  
 2x 26650  
 USB RECHARGEABLE LADOWANIE  
 100% 50% 25% FLASH  
 SOS SIGNAL  
 AL AIRCRAFT GRADE  
 HIGH POWER

- Torch made of durable and resistant aerospace aluminum • Three efficient CREE T6 high-power (1500 lm) LEDs • Built-in USB port for charging • LED indicating the battery's status during charging (red - charging, green - full battery) • Two replaceable batteries, 26650 type (each with a capacity of 3000 mAh) • Five operating modes (100%, 50%, 25%, FLASH, SOS) • Rubber seals for protection against water
- Included: charger, USB cable, torch case, batteries

Code	Operating mode	Box
51036	100%, 50%, 25%, FLASH, SOS	24

### 6 LED USB RECHARGEABLE FLASHLIGHT

• АККУМУЛЯТОРНЫЙ СВЕТОДИОДНЫЙ ФОНАРИК USB • WIEDERAUFLADBARE USB-LED-TASCHENLAMPE



2700 LUMEN  
 3XCREE U2 LED  
 3.7V d.c.  
 Li-Ion 6600 mAh  
 3x 26650  
 USB RECHARGEABLE LADOWANIE  
 100% 50% 25% FLASH  
 SOS SIGNAL  
 AL AIRCRAFT GRADE  
 HIGH POWER

- Torch made of durable and resistant aerospace aluminum • Three efficient CREE U2 high-power (2700 lm) LEDs • Built-in USB port for charging • LED indicating the battery's status during charging (red - charging, green - full battery) • Three replaceable batteries, 26650 type (each with a capacity of 3000 mAh) • Five operating modes (100%, 50%, 25%, FLASH, SOS) • Rubber seals for protection against water
- Included: charger, USB cable, torch case, batteries

Code	Operating mode	Box
51037	100%, 50%, 25%, FLASH, SOS	24

PROLINE

LANTI PRO

MEGA

JUCO

OTHER BRANDS

ERDI

KLINGSPOR

EXPRESS

ACTION CAN

TRYTON

VULCAN

### 1 LED WORK LIGHT

• СВЕТОДИОДНЫЙ ИНСПЕКЦИОННЫЙ ФОНАРИК • LED-ARBEIT-SLEUCHE



**51029** **LED** **3W** **180 LUMEN** **3xAAA** **3x1.5V d.c.** **AL**

- Compact, pen-shaped torch • Made of aluminum • Equipped with a long-lasting COB LED with a luminous flux of 180 lm
- Has a hanging clip and built-in magnet.
- 3xAAA power supply (not included) • Sold in a display box with 12 pieces (51029 refers to one piece)

Code	Length (mm)	Operating mode	
51029	165	100%	24/48

### 2 LED USB RECHARGEABLE FLASHLIGHT

• АККУМУЛЯТОРНЫЙ СВЕТОДИОДНЫЙ ФОНАРИК USB  
• WIEDERAUFLADBARE USB-LED-TASCHENLAMPE



**LED** **3W** **XTE LED** **3.7V d.c.** **Li-Ion** **600 mAh** **160 LUMEN**  
**USB** **RECHARGEABLE** **LADUWANIE** **100%** **50%** **FLASH** **SOS SIGNAL** **ZOOM** **AL**

- Compact, aluminum torch • Equipped with a long-lasting XTE LED with a luminous flux of 160 lm • Has a Li-Ion battery with 600 mAh capacity with a fixed USB socket assuring access to numerous power supply sources equipped with a USB port (for example powerbanks and USB sockets in cars, laptops, phone chargers) • ZOOM function
- Operating modes: 100%, 50%, FLASH, SOS (button held) • Includes a convenient wrist strap

Code	Length (mm)	Operating mode		
51030	95	100%, 50%, FLASH, SOS	x	8/32

### 3 RECHARGEABLE HEADLAMP

• НАЛОБНЫЙ ФОНАРИК С АККУМУЛЯТОРОМ • WIEDERAUFLADBARE STIRNLAMPE



**CE** **150 LUMEN** **CREE XPE LED** **1x 18650** **RECHARGEABLE** **LADUWANIE** **100%** **50%** **FLASH** **ZOOM** **AL** **AIRCRAFT GRADE** **HIGH POWER**

- Battery-powered headlamp ideal for field work • Adjustable head (up-down) • ZOOM function
- High quality CREE XPE LED with a luminous flux of 150 lm • Equipped with additional red light in the back, which increased the user's visibility and safety • Built-in USB port for charging the torch
- Replaceable 18650 battery (with a capacity of 2200 mAh) • Three operating modes (100%, 50%, FLASH) • Included: USB cable, charger, battery

Code	Operating mode	
51032	100%, 50%, FLASH	36

### 4 HEADLAMP

• НАЛОБНЫЙ ФОНАРИК • STIRNLAMPE



**CE** **135 LUMEN** **3xAAA** **3x1.5V d.c.** **CREE XPE LED** **100%** **50%** **FLASH** **SOS SIGNAL** **ZOOM** **HIGH POWER** **2in1** **AL** **AIRCRAFT GRADE**

- Battery-powered headlamp ideal for field work • Adjustable head (up-down) • ZOOM function
- High quality CREE XPE LED with a luminous flux of 150 lm • Equipped with additional red light in the back, which increased the user's visibility and safety • Built-in USB port for charging the torch
- Replaceable 18650 battery (with a capacity of 2200 mAh) • Three operating modes (100%, 50%, FLASH) • Included: USB cable, charger, battery

Code	Operating mode	
51031	100%, 50%, FLASH	48

### 1 HEX KEYS WITH T HANDLE

• КЛЮЧИ ТИП Т HEX • SECHSKANTSCHLÜSSEL MIT T-GRIFF



Code	⌀ (mm)	⊠	⊞
48520	2.5	x	24/144
48521	3	x	24/144
48522	4	x	24/96
48523	5	x	24/96
48524	6	x	24/96
48525	8	x	12/72
48526	10	x	12/72

### 2 BALL END HEX KEYS WITH T HANDLE

• КЛЮЧИ ТИП Т HEX С ШАРОМ • SECHSKANTSCHLÜSSEL MIT KUGELKOPF UND T-GRIFF



Code	⌀ (mm)	⊠	⊞
48527	2.5	x	24/144
48528	3	x	24/144
48529	4	x	24/96
48530	5	x	24/96
48531	6	x	24/96
48532	8	x	12/72
48533	10	x	12/72

### 3 TORX KEYS WITH T HANDLE

• КЛЮЧИ ТИП Т TORX • TORXSCHLÜSSEL MIT T-GRIFF



Code	Type	⊠	⊞
48534	T6	x	24/144
48535	T7	x	24/144
48536	T8	x	24/144
48537	T9	x	24/144
48538	T10	x	24/144
48539	T15	x	24/96
48540	T20	x	24/96
48541	T25	x	24/96
48542	T27	x	24/96
48543	T30	x	12/72
48544	T40	x	12/72
48545	T45	x	12/72
48546	T50	x	12/72

### 4 TORX SECURITY KEYS WITH T HANDLE

• КЛЮЧИ ТИП Т TORX SECURITY • TORX-SICHERHEITSSCHLÜSSEL MIT T-GRIFF



Code	Type	⊠	⊞
48547	T6	x	24/144
48548	T7	x	24/144
48549	T8	x	24/144
48550	T9	x	24/144
48551	T10	x	24/144
48552	T15	x	24/96
48553	T20	x	24/96
48554	T25	x	24/96
48555	T27	x	24/96
48556	T30	x	12/72
48557	T40	x	12/72
48558	T45	x	12/72
48559	T50	x	12/72

### 5 HEXAGON KEYS

• КЛЮЧИ ШТИФОВЫЕ ШЕСТИГРАННЫЕ Г-ОБРАЗНЫЕ • SECHSKANTSCHLÜSSEL



• Quenched and tempered - polished chromium

Code	⌀ (mm)	L1 (mm)	L2 (mm)	⊞
WRENCHES WITH A STANDARD LENGTH				
48441	1.5	42	13	100/600
48442	2	60	20	60/360
48442P	2.5	64	20	60/360
48443	3	68	20	50/300
48444	4	75	25	50/300
48445	5	82	28	150/900
48446	6	95	32	100/600
48447	7	100	34	80/480
48448	8	105	36	60/360
48449	9	115	48	50/300
48450	10	120	40	40/240
48452	12	125	44	20/120
48454	14	140	50	10/60
48457	17	160	53	4/24
48459	19	180	56	3/18
LONG WRENCHES				
48402	2	84	20	60/360
48402P	2.5	92	20	50/300
48403	3	98	20	50/300
48404	4	109	25	50/300
48405	5	120	28	150/900
48406	6	134	32	100/600
48407	7	142	34	60/360
48408	8	149	36	50/300
48409	9	160	38	40/240
48410	10	170	40	25/150
48412	12	195	44	20/120
48414	14	220	49	10/60
48417	17	250	53	4/24
48419	19	300	56	3/18

### 6 HEX KEYS, EXTRA LONG

• КЛЮЧИ ШТИФОВЫЕ ШЕСТИГРАННЫЕ ДЛИННЫЕ • SECHSKANTSCHLÜSSEL EXTRA LANG



• Quenched and tempered - polished chromium

Code	⌀ (mm)	L1 (mm)	L2 (mm)	⊞
48460	2	102	18	10/1000/2000
48461	2.5	114.5	20.5	10/500
48462	3	129	23	10/1000/4000
48463	4	144	29	200/1200
48464	5	165	33	10/250
48465	6	186	38	10/200
48466	7	197	41	10/200
48467	8	208	44	10/100/200
48468	9	219	47	35/140
48469	10	234	50	25/100
48470	12	262	57	10/40
48471	14	294	70	30
48472	17	350	70	15/30
48473	19	390	77	2/20

### 7 EX KEYS WITH BALL END

• КЛЮЧИ ШТИФОВЫЕ ШЕСТИГРАННЫЕ С ШАРОВЫМ НАКОНЕЧНИКОМ • SECHSKANTSCHLÜSSEL MIT KUGEL



• Quenched and tempered - polished chromium

Code	⌀ (mm)	L1 (mm)	L2 (mm)	⊞
WRENCHES WITH A STANDARD LENGTH				
48474	2	52	18	300/1800
48475	2.5	58.5	20.5	300/1800
48476	3	66	23	300/1800
48477	4	74	29	200/1200
48478	5	85	33	150/900
48479	6	90	38	100/400
48480	7	102	41	10/500
48481	8	108	44	64/320
48482	9	114	47	10/250
48483	10	122	50	10/100
LONG WRENCHES				
48565	2	84	20	200/1200
48566	2.5	92	20	200/1200
48567	3	98	20	200/1200
48568	4	109	25	150/900
48569	5	120	28	150/900
48570	6	134	32	100/600
48571	7	142	34	60/360
48572	8	149	36	50/300
48573	9	160	38	30/180
48574	10	170	40	25/150
EXTRA LONG WRENCHES				
48484	2	102	18	10/120/240
48485	2.5	114.5	20.5	200/1200
48486	3	129	23	200/1200
48487	4	144	29	200/1200
48488	5	165	33	150/600
48489	6	186	38	100/400
48490	7	197	41	60/240
48491	8	208	44	50/200
48492	9	219	47	35/140
48493	10	234	50	50/100
48494	12	262	57	15/60
48495	14	294	70	12/48
48496	17	340	75	6/24

**1 TORX KEYS**

• КЛЮЧИ ШТИФТОВЫЕ TORX • TORX-SCHLÜSSEL



• Quenched and tempered - polished chromium

Code	Type	L1 [mm]	L2 [mm]	
WRENCHES WITH A STANDARD LENGTH				
48497	T6	42	15	10/500/1000
48498	T7	44	15	10/500/1000
48499	T8	46	15	20/200
48500	T9	48	15	10/500/1000
48501	T10	48	17	10/500/1000
48502	T15	53	18	200/1200
48503	T20	58	19	200/1200
48504	T25	65	20	200/1200
48505	T27	72	21	150/900
48506	T30	80	24	150/900
48507	T40	90	26	100/600
48508	T45	102	28	70/420
48509	T50	115	32	50/300

LONG WRENCHES				
48510	T9	80	15	10/500/2000
48511	T10	90	17	10/500/1000
48512	T15	100	18	200/1200
48513	T20	110	19	200/1200
48514	T25	126	20	150/900
48515	T27	140	24	100/600
48516	T30	160	28	125/500
48517	T40	176	32	10/200
48518	T45	195	36	10/100
48519	T50	217	40	10/150

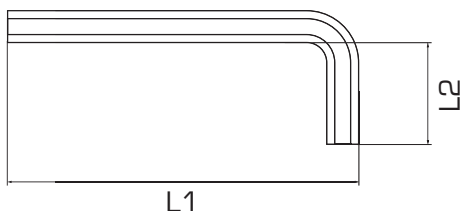

Quenched and tempered

Finish: polished chromium



**2 TORX SECURITY KEYS**

• КЛЮЧИ TORX SECURITY • TORX-SICHERHEITSSCHLÜSSEL



• Quenched and tempered - polished chromium

Code	Type	L1 [mm]	L2 [mm]	
WRENCHES WITH A STANDARD LENGTH				
48578	T9	48	15	300/1800
48579	T10	48	17	300/1800
48580	T15	53	18	200/1200
48581	T20	58	19	200/1200
48582	T25	65	20	200/1200
48583	T27	72	21	150/900
48584	T30	80	24	150/900
48585	T40	90	26	100/600
48586	T45	105	28	70/420
48587	T50	115	32	50/300

LONG WRENCHES				
48588	T9	80	15	200/1200
48589	T10	90	17	200/1200
48590	T15	100	18	200/1200
48591	T20	110	19	200/1200
48592	T25	126	20	150/900
48593	T27	140	24	100/600
48594	T30	160	28	100/600
48595	T40	176	32	60/360
48596	T45	195	36	40/240
48597	T50	217	40	30/180



**1 HEXAGON KEY SETS**

- НАБОР ШТИФОВЫХ ШЕСТИГРАННЫХ КЛЮЧЕЙ
- SECHSKANTSCHLÜSSELSÄTZE



**CrV HRC 58±2**

- Highly resistant to abrasion and twisting steel
- Metal ferrule covered with soft plastic
- **48367** - 2, 3, 4, 5, 6, 8, 10 mm • **48368** - 1.5, 2, 2.5, 3, 4, 5, 6, 8 mm

Code	Quantity (pcs)	Range (mm)	📦	📦
48367	7	2.0 - 10.0	x	12/48
48368	8	1.5 - 8.0	x	12/48

**2 BALL END HEXAGON KEY SET**

- НАБОР ШТИФОВЫХ ШЕСТИГРАННЫХ КЛЮЧЕЙ С ШАРОВОЙ ГОЛОВКОЙ
- SECHSKANTSCHLÜSSELSATZ MIT KUGEL



**x8 CrV HRC 58±2**

- Highly resistant to abrasion and twisting steel
- Metal ferrule covered with soft plastic
- Enable to use a wrench at the angle of up to 30° to the bolt axis
- **8 pcs.:** 1.5, 2, 2.5, 3, 4, 5, 6, 8 mm

Code	Range (mm)	📦	📦
48378	1.5 - 8.0	x	12/96

**3 TORX KEY SET**

- НАБОР ШТИФОВЫХ TORX КЛЮЧЕЙ
- TORX-SCHLÜSSELSATZ



**x8 CrV HRC 58±2**

- Highly resistant to abrasion and twisting steel
- Metal ferrule covered with soft plastic
- **8 pcs.:** T9, T10, T15, T20, T25, T27, T30, T40

Code	Range	📦	📦
48388	T9 - T40	x	12/96

**4 HEXAGON KEY SET**

- НАБОР ШТИФОВЫХ ШЕСТИГРАННЫХ Г-ОБРАЗНЫХ КЛЮЧЕЙ
- SECHSKANTSCHLÜSSELSATZ

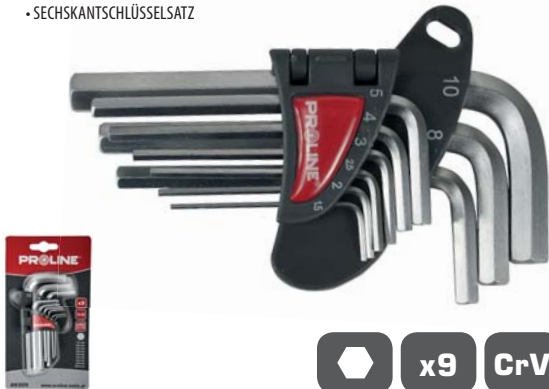

**x9 CrV HRC 58±2**

- Wrenches with a standard length
- **9 pcs.:** 1.5, 2, 2.5, 3, 4, 5, 6, 8, 10 mm

Code	Range (mm)	📦	📦
48309	1.5 - 10	x	6/36

**6 HEXAGON KEY SET, EXTRA LONG**

- НАБОР ШТИФОВЫХ ШЕСТИГРАННЫХ ДЛИННЫХ Г-ОБРАЗНЫХ КЛЮЧЕЙ
- SECHSKANTSCHLÜSSELSATZ LANG



**x9 CrV HRC 58±2**

- Long wrenches
- **9 pcs.:** 1.5, 2, 2.5, 3, 4, 5, 6, 8, 10 mm

Code	Range (mm)	📦	📦
48319	1.5 - 10	x	6/36

**5 BALL END HEXAGON KEY SET**

- НАБОР ШТИФОВЫХ ШЕСТИГРАННЫХ Г-ОБРАЗНЫХ КЛЮЧЕЙ С ШАРОВОЙ ГОЛОВКОЙ
- SECHSKANTSCHLÜSSELSATZ MIT KUGEL



**x9 CrV HRC 58±2**

- Long wrenches
- Ball ends enable to use a wrench at the angle of up to 30° to the bolt axis
- **9 pcs.:** 1.5, 2, 2.5, 3, 4, 5, 6, 8, 10 mm

Code	Range (mm)	📦	📦
48329	1.5 - 10	x	6/36

**7 TORX KEY SET**

- НАБОР ШТИФОВЫХ TORX Г-ОБРАЗНЫХ КЛЮЧЕЙ
- TORX-SCHLÜSSELSATZ

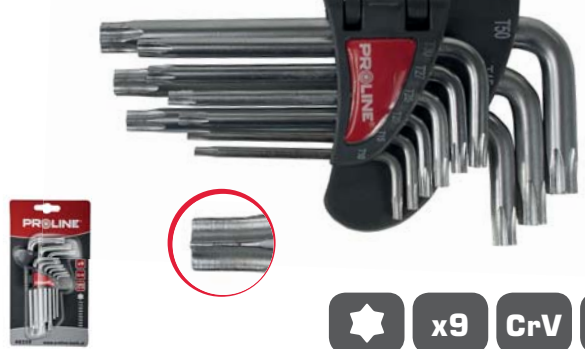

**x9 CrV HRC 58±2**

- Wrenches with a standard length
- **9 pcs.:** T10, T15, T20, T25, T27, T30, T40, T45, T50

Code	Range	📦	📦
48339	T10 - T50	x	6/36

PROLINE

LANITI PRO

MEGA

JUCO

OTHER BRANDS

ERDI

KUNGSFOR

EXPRESS

ACTION CAN

TRYTON

VULCAN

### 1 HEXAGON KEY SET

- НАБОР ШТИФТОВЫХ ШЕСТИГРАННЫХ Г-ОБРАЗНЫХ КЛЮЧЕЙ
- SECHSKANTSCHLÜSSELSATZ



- Standard length wrenches • 1.5, 2.0, 2.5, 3.0, 4.0, 5.0, 6.0, 8.0, 10.0 mm • Covered handle

Code	
<b>48310</b>	6/36

### 3 BALL END HEXAGON KEY SET

- НАБОР ШТИФТОВЫХ ШЕСТИГРАННЫХ Г-ОБРАЗНЫХ КЛЮЧЕЙ С ШАРОВОЙ ГОЛОВКОЙ
- KUGELKOPF SECHSKANTSCHLÜSSEL-SATZ



- Long wrenches • Ball ends enable to use wrenches at the angle of up to 30° to the bolt axis • 1.5, 2.0, 2.5, 3.0, 4.0, 5.0, 6.0, 8.0, 10.0 mm • Covered handle

Code	
<b>48330</b>	6/36

### 2 HEXAGON KEY SET, EXTRA LONG

- НАБОР ШТИФТОВЫХ ШЕСТИГРАННЫХ Г-ОБРАЗНЫХ КЛЮЧЕЙ
- SECHSKANTSCHLÜSSELSATZ, EXTRA LANG



- Long wrenches • 1.5, 2.0, 2.5, 3.0, 4.0, 5.0, 6.0, 8.0, 10.0 mm • Covered handle

Code	
<b>48320</b>	6/36

### 4 TORX KEY SET

- НАБОР ШТИФТОВЫХ TORX Г-ОБРАЗНЫХ КЛЮЧЕЙ • TORX-SCHLÜSSELSATZ



- Standard length wrenches • T10, T15, T20, T25, T27, T30, T40, T45, T50 • Covered handle

Code	
<b>48340</b>	6/36























# PROLINE SCREWDRIVER BITS

Screwdriver bits are tools that, combined with a 1/4 "hex socket, a screwdriver handle or a power tool holder, form one work-ready tool. Strength for screwing in various types of screws and bolts is obtained by using high-strength chrome-vanadium steel or molybdenum steel and heat treating to a hardness of 56-60 HRC.







For soft materials, such as wood, use very hard bits, while for metals, bits with a torsion zone. Using a tip with appropriate material properties has a significant impact on the way the bit tip behaves in the screw socket. Using the right tip eliminates the risk of breaking bits and grinding down screw sockets

Choosing the bit type begins with determining the type of socket in the screws that will be used. Next, the working conditions of the bit need to be established, i.e. with which tools or devices will it be used and in what material. Its purpose also needs to be determined – will it be used for batch or unit work.

## BIT TYPES DEPENDING ON THE SHAPE OF WORKING PART

Bits	Picture	Description
		Plain slot
		Phillips (PH)
		Pozidrive (PZ)
		TORX
		TORX security (security)
		Hexagon
		Spanner
		Tri-Wing
		Spline
		Ribe

## BIT TYPES DEPENDING ON LENGTH

Bits	Picture	Description	Length
		Standard bits	25 mm
		Long bits	50-150 mm
		Reversible bits	50 mm

## BIT TYPES DEPENDING ON MOUNT

1/4" = 6,35 mm	3/8" = 10 mm	5/16" = 8 mm
----------------	--------------	--------------



# БИТЫ ДЛЯ ОТВЕРТОК PROLINE

Биты для отверток - это инструменты, которые в сочетании с шестигранным гнездом, рукояткой отвертки или держателем электроинструмента образуют один готовый к работе инструмент.





















Прочность для ввинчивания различных типов шурупов и болтов достигается использованием высокопрочной хромованадиевой стали или молибденовой стали с термообработкой до твердости 56-60 HRC.

Выбор бит начинается с определения типа гнезда в винтах, которые будут использоваться. После этого необходимо определить рабочие условия работы, то есть с какими инструментами/устройствами и для какого материала они





будут использоваться. Также необходимо определить будут ли биты использоваться для многократной или единичной работы.

Для мягких материалов, таких как древесина, используйте биты повышенной твердости, а для металлов - биты с торсионной зоной. Использование наконечника с соответствующими свойствами материала оказывает значительное влияние на поведение биты в гнезде винта. Использование правильного наконечника исключает риск поломки бит и стачивания гнезд винтов

## ВИДЫ БИТ В ЗАВИСИМОСТИ ОТ ФОРМЫ РАБОЧЕГО ЭЛЕМЕНТА

Биты	Изображение	Описание
		Гладкая прорезь
		Phillips (PH)
		Pozidrive (PZ)
		TORX
		TORX security
		Шестиугольник
		Гайковерт
		Tri-Wing
		Шлицы
		Ребро

## ВИДЫ БИТ В ЗАВИСИМОСТИ ОТ ДЛИНЫ

Биты	Изображение	Описание	Длина
		Стандартные биты	25 мм
		Длинные биты	50-150 мм
		Двухсторонние биты	50 мм

## ВИДЫ БИТ В ЗАВИСИМОСТИ ОТ КРЕПЛЕНИЯ

1/4" = 6,35 мм	3/8" = 10 мм	5/16" = 8 мм
----------------	--------------	--------------





# PROLINE SCHRAUBENDREHER-BITS

Schraubendreher-Bits sind Werkzeuge, die zusammen mit einem 1/4" Innensechskantbithalter, einen Schraubendrehergriff oder einen Elektrowerkzeughalter ein einsatzbereites Werkzeug bilden.





















Die Festigkeit für das Einschrauben verschiedener Arten von Schrauben und Bolzen wird erzielt, indem hochfester Chrom-Vanadium-Stahl oder Molybdänstahl verwendet und eine Wärmebehandlung durchgeführt wird, sodass eine Härte von 56 - 60 HRC erzielt wird.

Die Auswahl des Bit-Typs beginnt mit der Bestimmung der Kopfart der verwendeten Schrauben. Als nächstes müssen die Arbeitsbedingungen für den Bit festgelegt werden, z. B. mit welchen Werkzeugen oder Geräten soll der Bit zusammen verwendet werden und in welchem Material. Sein Zweck muss ebenfalls bestimmt werden - soll er für





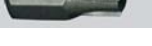

Serien oder Einzelarbeiten eingesetzt werden.

Für weiche Materialien, wie Holz, müssen Bits mit sehr hoher Härte verwendet werden, und für Metalle müssen Bits mit Torsionsbereich verwendet werden. Die Verwendung einer Spitze mit entsprechenden Materialeigenschaften hat einen erheblichen Einfluss auf das Verhalten der Bit-Spitze im Schraubendreherhalter. Durch die Verwendung der korrekten Spitze besteht die Gefahr behoben, dass Bits brechen und Schraubenköpfe heruntergeschliffen werden.

## BITARTEN NACH DER FORM DES ARBEITSPROFILS

Bits	Bild	Beschreibung
		Einfacher Schlitz
		Phillips (PH)
		Pozidriv (PZ)
		TORX
		TORX security (security)
		Innensechskant
		Spanner
		Tri-Wing
		Spline
		Ribe

## BITARTEN NACH LÄNGE

Bits	Bild	Beschreibung	Länge
		Standardbits	25 mm
		Lange Bits	50-150 mm
		Doppelseitige Bits	50 mm

## BITARTEN NACH BEFESTIGUNG

1/4" = 6,35 mm	3/8" = 10 mm	5/16" = 8 mm
----------------	--------------	--------------



PROLINE

LAHTI PRO

MEGA

JUCO

OTHER BRANDS

ERDI

KLINGSPOR

EXPRESS

ACTION CAN

TRYTON

VULCAN

**1 PLAIN SLOT BITS 1/4", 25 MM**

• ШЛИЦЕВЫЕ БИТЫ 1/4", 25 MM • BITS FLACH 1/4", 25 MM



Code	Size (mm)	Quantity (pcs)	BOX	
10614	4.5 x 0.5	10	x	50/100
10615	5.5 x 0.8	10	x	50/100
10616	6.5 x 1.2	10	x	50/100
10618	8.0 x 1.6	10	x	50/100

**4 HEXAGON BITS 1/4", 25 MM**

• ШЕСТИГРАННЫЕ БИТЫ 1/4", 25 MM  
• BITS IMBUS 1/4", 25 MM



Code	Size (mm)	Quantity (pcs)	BOX	
10603	3	10	x	30/60
10604	4	10	x	50/100
10605	5	10	x	50/100
10606	6	10	x	50/100

**7 PZ BITS 1/4", 25 MM**

• БИТЫ PZ 1/4", 25 MM • BITS POZIDRIVE 1/4", 25 MM



Code	Type	Quantity (pcs)	BOX	
10630	PZ 0	25	x	40/80
10631	PZ 1	25	x	40/80
10632	PZ 2	25	x	40/80
10633	PZ 3	25	x	40/80

**2 PH BITS 1/4", 25 MM**

• БИТЫ КРЕСТОВЫЕ PHILLIPS (PH) 1/4", 25 MM  
• BITS KREUZ 1/4", 25 MM



Code	Type	Quantity (pcs)	BOX	
10620	PH 0	25	x	40/80
10621	PH 1	25	x	40/80
10622	PH 2	25	x	40/80
10623	PH 3	25	x	40/80

**5 TORX BITS 1/4", 25 MM**

• БИТЫ TORX 1/4", 25 MM • BITS TORX SECURITY, 1/4", 25 MM



Code	Type	Quantity (pcs)	BOX	
10652	T6	10	x	30/60
10653	T7	10	x	30/60
10654	T8	10	x	30/60
10655	T9	10	x	30/60
10656	T10	10	x	30/60
10657	T15	10	x	50/100
10658	T20	10	x	50/100
10659	T25	10	x	50/100
10660	T27	10	x	30/60
10661	T30	10	x	30/60
10662	T40	10	x	30/60

**8 PZ BITS 1/4", 50 MM**

• БИТЫ PZ 1/4", 50 MM • BITS POZIDRIVE 1/4", 50 MM



Code	Type	Quantity (pcs)	BOX	
10636	PZ 1	10	x	50/100
10637	PZ 2	10	x	50/100
10638	PZ 3	10	x	50/100

**3 PH BITS 1/4", 50 MM**

• БИТЫ КРЕСТОВЫЕ PHILLIPS (PH), 1/4", 50 MM  
• BITS KREUZ 1/4", 50 MM



Code	Type	Quantity (pcs)	BOX	
10626	PH 1	10	x	50/100
10627	PH 2	10	x	50/100
10628	PH 3	10	x	50/100

**6 TORX SECURITY BITS 1/4", 25 MM**

• БИТЫ TORX С ОТВЕРСТИЕМ 1/4", 25 MM • BITS TORX SECURITY, 1/4", 25 MM



Code	Type	Quantity (pcs)	BOX	
10672	T6	10	x	30/60
10673	T7	10	x	30/60
10674	T8	10	x	30/60
10675	T9	10	x	30/60
10676	T10	10	x	30/60
10677	T15	10	x	30/60
10678	T20	10	x	30/60
10679	T25	10	x	30/60
10680	T27	10	x	30/60
10681	T30	10	x	30/60
10682	T40	10	x	30/60

**9 REVERSIBLE BITS 1/4", 50 MM**

• ДВУХСТОРОННИЕ БИТЫ 1/4", 50 MM • BITS DOPPELSEITIG 1/4", 50 MM



Code	Type	Quantity (pcs)	BOX	
10641	PH 1 x PH 2	10	x	50/100
10642	PH 2 x PZ 2	10	x	50/100
10643	PZ 1 x PZ 2	10	x	50/100

**1 HEXAGON BITS 1/4", 25 MM**  
 • ШЕСТИГРАННЫЕ БИТЫ 1/4", 25 MM • BIBITS IMBUS 1/4", 25 MM



		<b>1/4"</b>	<b>S2</b>	<b>HRC 58±2</b>
Code	(mm)	Quantity (pcs)		
10610	3	2	x	30/240
10611	4	2	x	30/240

**4 PLAIN SLOT BITS 1/4", 25 MM**  
 • ШЛИЦЕВЫЕ БИТЫ 1/4", 25 MM • GLATTE SCHLITZBITS 1/4", 25 MM



		<b>1/4"</b>	<b>S2</b>	<b>HRC 58±2</b>
Code	(mm)	Quantity (pcs)		
10669	4.5	2	x	30/240
10670	5.5	2	x	30/240
10671	6.5	2	x	30/240

**7 SPANNER BITS 1/4", 150 MM**  
 • БИТЫ SPANNER 1/4", 150 MM • SCHLÜSSEL-BITS 1/4", 150 MM



		<b>1/4"</b>	<b>S2</b>	<b>HRC 58±2</b>	
Code	Type	Length (mm)	Quantity (pcs)		
10874	4	150	2	x	25/200
10875	6	150	2	x	25/200
10876	8	150	2	x	25/200
10877	10	150	2	x	25/200

**2 PH BITS 1/4"**  
 • БИТЫ КРЕСТОВЫЕ PHILLIPS (PH) 1/4" • BIBITS KREUZ 1/4"



	<b>1/4"</b>	<b>S2</b>	<b>HRC 58±2</b>		
Code	Type	Length (mm)	Quantity (pcs)		
10644	PH1	25	2	x	30/240
10645	PH2	25	2	x	30/240
10646	PH3	25	2	x	30/240
10647	PH1	50	2	x	25/200
10648	PH2	50	2	x	25/200
10649	PH3	50	2	x	25/200

**5 DRY WALL BITS 1/4"**  
 • БИТЫ 1/4" ДЛЯ ШУРУПОВ ДЛЯ ГИПСОКАРТОНА • TROCKEN-MAUER-BITS 1/4"



	<b>1/4"</b>	<b>S2</b>	<b>HRC 58±2</b>	<b>GK</b>
Code	Type	Length (mm)	Quantity (pcs)	
10822	PH2	25	10	40/80
10823	PZ2	25	10	40/80

**8 TRI-WING BITS 1/4", 25 MM**  
 • БИТЫ TRI-WING 1/4", 25 MM • TRI-WING-BITS 1/4", 25 MM



		<b>1/4"</b>	<b>S2</b>	<b>HRC 58±2</b>	
Code	Type	Length (mm)	Quantity (pcs)		
10878	1	25	2	x	30/240
10879	2	25	2	x	30/240
10880	3	25	2	x	30/240

**3 PZ BITS 1/4"**  
 • БИТЫ PZ 1/4" • BIBITS POZIDRIVE 1/4"



	<b>1/4"</b>	<b>S2</b>	<b>HRC 58±2</b>		
Code	Type	Length (mm)	Quantity (pcs)		
10663	PZ1	25	2	x	30/240
10664	PZ2	25	2	x	30/240
10665	PZ3	25	2	x	30/240
10666	PZ1	50	2	x	25/200
10667	PZ2	50	2	x	25/200
10668	PZ3	50	2	x	25/200

**6 SPANNER BITS 1/4", 25 MM**  
 • БИТЫ SPANNER 1/4", 25 MM • SCHLÜSSEL-BITS 1/4", 25 MM



		<b>1/4"</b>	<b>S2</b>	<b>HRC 58±2</b>	
Code	Type	Length (mm)	Quantity (pcs)		
10870	4	25	2	x	30/240
10871	6	25	2	x	30/240
10872	8	25	2	x	30/240
10873	10	25	2	x	30/240

**9 TRI-WING BITS 1/4", 150 MM**  
 • БИТЫ TRI-WING 1/4", 150 MM • TRI-WING-BITS 1/4", 150 MM



		<b>1/4"</b>	<b>S2</b>	<b>HRC 58±2</b>	
Code	Type	Length (mm)	Quantity (pcs)		
10881	1	150	2	x	25/200
10882	2	150	2	x	25/200
10883	3	150	2	x	25/200

PROLINE

LAHTI PRO

MEGA

JUCO

OTHER BRANDS

ERDI

KLINGSPOR

EXPRESS

ACTION CAN

TRAYTON

VULCAN

**1 PH BITS 1/4", 100 MM**

• БИТЫ PHILIPS 1/4", 100 MM • PH-BITS 1/4", 100 MM



Code	Type	Length (mm)	Quantity (pcs)	Box	Case
10800	PH 0	100	2	x	25/200
10801	PH 1	100	2	x	25/200
10802	PH 2	100	2	x	25/200
10803	PH 3	100	2	x	25/200

**2 PZ BITS 1/4", 100MM**

• БИТЫ POZIDRIVE 1/4", 100 MM • PZ-BITS 1/4", 100 MM



Code	Type	Length (mm)	Quantity (pcs)	Box	Case
10804	PZ1	100	2	x	25/200
10805	PZ2	100	2	x	25/200
10806	PZ3	100	2	x	25/200

**3 TORX BITS 1/4", 100 MM**

• БИТЫ TORX 1/4", 100 MM • TORX-BITS 1/4", 100 MM



Code	Type	Length (mm)	Quantity (pcs)	Box	Case
10807	T6	100	2	x	25/200
10808	T7	100	2	x	25/200
10809	T8	100	2	x	25/200
10810	T10	100	2	x	25/200
10811	T15	100	2	x	25/200
10812	T20	100	2	x	25/200
10813	T25	100	2	x	25/200
10814	T27	100	2	x	25/200
10815	T30	100	2	x	25/200
10816	T40	100	2	x	25/200

**4 HEXAGON BITS 1/4", 100MM**

• БИТЫ HEX 1/4", 100 MM • SECHSKANT-BITS 1/4", 100 MM



Code	Length (mm)	Quantity (pcs)	Box	Case	
10817	H2	100	2	x	25/200
10818	H3	100	2	x	25/200
10819	H4	100	2	x	25/200
10820	H5	100	2	x	25/200
10821	H6	100	2	x	25/200

**5 TORX BITS 3/8" (10 MM), 30 MM**

• БИТЫ TORX 3/8" (10 MM), 30 MM • TORX-BITS 3/8" (10 MM), 30 MM



Code	Type	Length (mm)	Quantity (pcs)	Box	Case
10847	T20	30	2	x	36/216
10848	T25	30	2	x	36/216
10849	T27	30	2	x	36/216
10850	T30	30	2	x	36/216
10851	T40	30	2	x	36/216
10852	T45	30	2	x	36/216
10853	T50	30	2	x	36/216
10854	T55	30	2	x	36/216

**6 TORX BITS 3/8" (10 MM), 75 MM**

• БИТЫ TORX 3/8" (10 MM), 75 MM • TORX-BITS 3/8" (10 MM), 75 MM



Code	Type	Length (mm)	Quantity (pcs)	Box	Case
10824	T20	75	2	x	24/144
10825	T25	75	2	x	24/144
10826	T27	75	2	x	24/144
10827	T30	75	2	x	24/144
10828	T40	75	2	x	24/144
10829	T45	75	2	x	24/144
10830	T50	75	2	x	24/144
10831	T55	75	2	x	24/144

**7 HEXAGON BITS 3/8" (10 MM), 30 MM**

• БИТЫ HEX 3/8" (10 MM), 30 MM • SECHSKANT-BITS 3/8" (10 MM), 30 MM



Code	Length (mm)	Quantity (pcs)	Box	Case	
10855	H4	30	2	x	36/216
10856	H5	30	2	x	36/216
10857	H6	30	2	x	36/216
10858	H7	30	2	x	36/216
10859	H8	30	2	x	36/216
10860	H9	30	2	x	36/216
10861	H10	30	2	x	36/216
10862	H12	30	2	x	36/216

**8 HEXAGON BITS 3/8" (10 MM), 75 MM**

• БИТЫ HEX 3/8" (10 MM), 75 MM • SECHSKANT-BITS 3/8" (10 MM), 75 MM



Code	Length (mm)	Quantity (pcs)	Box	Case	
10832	H4	75	2	x	24/144
10833	H5	75	2	x	24/144
10834	H6	75	2	x	24/144
10835	H7	75	2	x	24/144
10836	H8	75	2	x	24/144
10837	H9	75	2	x	24/144
10838	H10	75	2	x	24/144
10839	H12	75	2	x	24/144

**9 SPLINE BITS 3/8" (10 MM), 30 MM**

• БИТЫ SPLINE 3/8" (10 MM), 30 MM • KEILBITS 3/8" (10 MM), 30 MM



Code	Type	Length (mm)	Quantity (pcs)	Box	Case
10863	M5	30	2	x	36/216
10864	M6	30	2	x	36/216
10865	M7	30	2	x	36/216
10866	M8	30	2	x	36/216
10867	M9	30	2	x	36/216
10868	M10	30	2	x	36/216
10869	M12	30	2	x	36/216

**10 SPLINE BITS 3/8" (10 MM), 75 MM**

• БИТЫ SPLINE 3/8" (10 MM), 75 MM • KEILBITS 3/8" (10 MM), 75 MM



Code	Type	Length (mm)	Quantity (pcs)	Box	Case
10840	M5	75	2	x	24/144
10841	M6	75	2	x	24/144
10842	M7	75	2	x	24/144
10843	M8	75	2	x	24/144
10844	M9	75	2	x	24/144
10845	M10	75	2	x	24/144
10846	M12	75	2	x	24/144

**1 BIT HOLDER 1/4"**

• ДЕРЖАТЕЛЬ ДЛЯ БИТ 1/4" • BITHALTER 1/4"



• Two-component handle made from hard and soft non-slip material

Code	End (Type x Length mm)	Quantity	Box
10900	1/4" x 75	x	12/120

**2 MAGNETIC BIT HOLDER 1/4"**

• МАГНИТНЫЙ ПЕРЕХОДНИК (АДАПТЕР) ДЛЯ БИТ 1/4" • MAGNET-BITHALTER, 1/4"



Code	Length (mm)	Quantity (pcs)	Box
10601	60	5	x 50/100

**3 MAGNETIC BIT HOLDER 1/4"**

• ДЕРЖАТЕЛЬ ДЛЯ БИТ 1/4" • MAGNETISCHER BITHALTER 1/4"



Code	End (Type x Length mm)	Quantity	Box
10708	1/4" x 75	x	24/288
10709	1/4" x 100	x	24/288
10710	1/4" x 150	x	24/288

**4 QUICK RELEASE BIT HOLDER 1/4"**

• ДЕРЖАТЕЛЬ ДЛЯ БИТ 1/4" • BITHALTER MIT SCHNELLSPANNER 1/4"



Code	End (Type x Length mm)	Quantity	Box
10712	1/4" x 100	x	18/216
10713	1/4" x 150	x	18/216

**5 SOCKET BITS 1/4"**

• БИТЫ 1/4" С ТОРЦЕВОЙ ШЕСТИГРАННОЙ (ВНЕШНЕЙ) ГОЛОВКОЙ • BITS MIT SECHSKANTEINSÄTZEN 1/4"



Code	Size (mm)	Box	Quantity
10690	6	x	30/60
10691	8	x	30/60
10692	10	x	30/60
10693	12	x	30/60
10694	13	x	30/60

**6 1/4" ADAPTOR**

• ПЕРЕХОДНИК (АДАПТЕР) ДЛЯ БИТ С КВАДРАТОМ 1/4" • ITHALTER, QUADRAT 1/4"



Code	Quantity (pcs)	Box	Quantity
10602	5	x	30/60

**7 1/4" HEX SOCKET ADAPTOR SET, 1/4", 3/8", 1/2"**

• ПЕРЕХОДНИК (АДАПТЕР) ДЛЯ БИТ С КВАДРАТОМ 1/4", 3/8", 1/2", HEX 1/4", 3/8", 1/2", HEX 1/4"



• Handle length 65 mm for 1/4" and 3/8" and 72 mm for 1/2" respectively enabling problem-free work

Code	Quantity (pcs)	Box	Quantity
31395	3	x	30/60

PROLINE

LAHTI PRO

MEGA

JUCO

OTHER BRANDS

ERDI

KLINGSPOR

EXPRESS

ACTION CAN

TRAYTON

VULCAN

**1 7 PC. HEX BIT SET H4-H12**

• НАБОР 7 ШТ. БИТ 10 MM HEX H4-H12 • 7 ШТК. HEX-BITSATZ H4-H12



x7 10 mm 1/2" S2

• The set includes: • HEX H4, H5, H6, H8, H10, H12 L=30 mm • 10 mm 1/2"

Code	Quantity (pcs)	
10750	7	24/48

**4 15 PC. TORX „SECURITY“ BIT SET T20-T55**

• НАБОР 15 ШТ. БИТ 10 MM TORX "SECURITY" T20-T55 • 15 ШТК. TORX "SICHERHEITS"-BITSATZ T20-T55



x15 10 mm 1/2" S2 HRC 60±2

• The set includes: • 10 mm 1/2" • T20, T25, T30, T40, T45, T50, T55, 30 mm and 75 mm one item each

Code	Quantity (pcs)	
10745	15	25

**7 8 PC. RIBE BIT SET M5-M14**

• НАБОР 8 ШТ. БИТ 10 MM RIBE M5-M14 • 8 ШТК. RIBE-BIT-SATZ M5-M14



x8 10 mm 1/2" S2

• The set includes: • RIBE M5, M6, M7, M8, M10, M12, M14 L=30 mm • 10 mm 1/2"

Code	Quantity (pcs)	
10753	8	24/48

**2 15 PC. HEX BIT SET H4-H12**

• НАБОР 15 ШТ. БИТ 10 MM HEX H4-H12 • 15 ШТК. HEX-BITSATZ H4-H12



x15 10 mm 1/2" S2 HRC 60±2

• The set includes: • 10 mm 1/2" • H4, H5, H6, H7, H8, H10, H12 30 mm and 75 mm one item each

Code	Quantity (pcs)	
10743	15	25

**5 7 PC. TORX BIT SET T25-T55**

• НАБОР 7 ШТ. БИТ 10 MM TORX T25-T55 • 7 ШТК. TORX BITSATZ T25-T55



x7 10 mm 1/2" S2

• The set includes: • TORX T25, T30, T40, T45, T50, T55 L=30 mm • 10 mm 1/2"

Code	Quantity (pcs)	
10749	7	24/48

**8 15 PC. RIBE BIT SET M6-M14**

• 15 PC. RIBE BIT SET M6-M14 • 15 ШТК. RIBE-BIT-SATZ M6-M14



x15 10 mm 1/2" S2 HRC 60±2

• The set includes: • 10 mm 1/2" • M6, M7, M8, M9, M10, M12, M14, 30 mm and 75 mm one item each

Code	Quantity (pcs)	
10746	15	25

**3 7 PC. TORX „SECURITY“ BIT SET T20-T55**

• НАБОР 7 ШТ. БИТ TORX "SECURITY" T20-T55 • 7 ШТК. TORX "SICHERHEITS"-BITSATZ T20-T55



x7 10 mm 1/2" S2

• The set includes: • TORX SECURITY T20, T30, T40, T45, T50, T55 L=30 mm • 10 mm 1/2"

Code	Quantity (pcs)	
10752	7	24/48

**6 15 PC. TORX BIT SET 10MM T20-T55**

• НАБОР 15 ШТ. БИТ 10 MM TORX T20-T55 • 15 ШТК. TORX-BITSATZ 10MM T20-T55



x15 10 mm 1/2" S2 HRC 60±2

• The set includes: • 10 mm 1/2" • T20, T25, T30, T40, T45, T50, T55, 30 mm and 75 mm one item each

Code	Quantity (pcs)	
10741	15	25

**9 6 PC. SPLINE BIT SET M5-M12**

• НАБОР 6 ШТ. БИТ 10 MM SPLINE M5-M12 • 6 ШТК. KEILBIT-SATZ M5-M12



x6 10 mm 1/2" S2

• The set includes: • SPLINE M5, M6, M8, M10, M12 L=30 mm • 10 mm 1/2"

Code	Quantity (pcs)	
10751	6	24/48

**1 11 PC. SPLINE BIT SET M5-M12**  
 • НАБОР 11 ШТ. БИТ 10 MM SPLINE M5-M12 • 11 STK. KEIL-BIT-SATZ M5-M12



x11 10 mm 1/2" S2 HRC 60±2

- The set includes: • 10 mm 1/2"
- M5, M6, M8, M10, M12, 30 mm and 75 mm one item each

Code	Quantity (pcs)	
10744	11	25

**2 30 PC PRECISION BIT SET**  
 • НАБОР 30 ШТ. БИТ ДЛЯ ТОЧНЫХ РАБОТ, С ДЕРЖАТЕЛЕМ  
 • 30 STÜCK PRÄZISIONSBITSATZ



x30 5/32" CrMo HRC 58±2

- The set includes: 1.0, 1.5, 2.0, 2.5, 3.0, 3.5, 4.0, PH000, PH00, PH0, PH1, PZ0, PZ1, T4, T5, T6, T7, T8, T9, T10, T15, T20, H0.7, H0.9, H1.3, H1.5, H2.0, H2.5, H3.0, H4.0
- Made of S2 high quality steel

Code	Quantity (pcs)		
10228	30	X	12/72

**3 42 PC. RIBE/ TORX BIT SET M4-M14, T20-T70**  
 • НАБОР 42 ШТ. БИТ 10 MM RIBE M4-M14, TORX T20-T70  
 • 42 STK. RIBE/TORX-BIT-SATZ M4-M14, T20-T70



x42 10 mm 1/2" S2 HRC 60±2

- The set includes: • 10 mm 1/2", 10 mm
- M4, M5, M6, M7, M8, M9, M10, M11, M12, M13, M14, T20, T25, T30, T40, T45, T50, T55, T60, T70, 30 mm and 75 mm one item each

Code	Quantity (pcs)	
10747	42	10

**4 27 PC BIT AND SOCKET SET 1/4"**  
 • НАБОР 27 ШТ. БИТ С ТРЕЩОТОЧНЫМ КЛЮЧОМ И ДЕРЖАТЕЛЕМ 1/4" • 27 STK. BIT- UND STECKSCHLÜSSEL-SATZ 1/4"



x27 1/4" 60 S2 CrV HRC 58±2

- The set includes: 4.0, 5.0, 6.0, PH1, PH2, PH3, PZ1, PZ2, PZ3, T10, T15, T20, T25, T30, H3, H4, H5, H6, 1/4", 1/4" 60T. • Made of S2 high quality steel

Code	Quantity (pcs)		
10701	27	X	20

**5 40 PC XZN, TORX, HEX BIT SET**  
 • НАБОР 40 ШТ. БИТ XZN, TORX, HEX • 40 STK. XZN, TO RX, HEX BIT-SATZ



x40 3/8" 1/2" S2 HRC 60±2

- The set includes: • 3/8" 10 mm • 1/2" 10 mm • 10 mm TORX T20, T25, T30, T40, T45, T50, T55 po 1 pcs. 30 and 75 mm XZN M5, M6, M8, M10, M12, 30 and 75 mm HEX 4, 5, 6, 7, 8, 10, 12 mm, 30 and 75 mm one item each

Code	Quantity (pcs)	
10748	40	10

**6 27 PC BIT AND SOCKET SET 1/4"**  
 • НАБОР 27 ШТ. БИТ И ГОЛОВОК С ТРЕЩОТОЧНЫМ КЛЮЧОМ И ДЕРЖАТЕЛЕМ 1/4" • 27 STK. BIT- UND STECKSCHLÜSSEL-SATZ 1/4"



x27 1/4" 60 S2 CrV HRC 58±2

- The set includes: 4.0, 5.0, 6.0, PH2, PH3, PZ2, PZ3, T10, T15, T20, T25, T30, H3, H4, H5, H6, 5, 6, 7, 8, 9, 10, 11, 13mm, 1/4", 1/4" 60T. • Made of S2 high quality steel

Code	Quantity (pcs)		
10702	27	X	20

**1 32 PC BIT SET 1/4"**

• НАБОР 32 ШТ. БИТ, 1/4" • 32-STK. BIT-SATZ 1/4"



**1/4" S2 CrV HRC 58±2** **x32**

• The set includes: SL 3, 4, 5, 6 PH 1, 2, 3 PZ 1, 2, 3 O 1, 2, 3 H 3, 4, 5, 6 TS 10, 15, 20, 25, 27, 30, 40 SPLINE 4, 5, 6, 8 1/4" 60 mm • Made of S2 high quality steel

Code	Quantity (pcs)		
10705	32	X	20

**3 71 PC BIT SET 1/4"**

• НАБОР 71 ШТ. БИТ, 1/4" • 71 STK. BIT-SATZ 1/4"



**1/4" S2 CrV HRC 58±2** **x71**

• The set includes: 4, 5, 6 PH 1, 2, 3 PZ 1, 2, 3 O 1, 2, 3 H 4, 5, 6 T 10, 15, 20, 25, 27, 30 SPANNER 4, 6, 8, 10 TORX 6, 8, 10 CLUTCH 1, 2, 3 RIBE 4, 5, 6, 7 SPLINE 4, 5, 6, 8 TRIMING 1, 2, 3, 4 1/4" 60 mm 1/4" 60 mm • Made of S2 high quality steel

Code	Quantity (pcs)		
10703	71	X	20

**4 22 PC BIT AND SOCKET SCREWDRIVER SET**

• НАБОР 22 ШТ. С ОТВЕРТЧОЧНЫМИ БИТАМИ И БИТАМИ С ТОРЦЕВЫМИ ШЕСТИУГОЛЬНЫМИ ГОЛОВКАМИ • SCHRAUBENDREHER MIT BITS UND EINSÄTZEN – 22 STK.



**x22** **CrV** **HRC 52±2**

• The set includes: • 1/4" • 1/4" • 1/4" 6, 8, 10, 13 mm • 1/4" PH 1, 2, 3 PZ 1, 2, 3 O 4, 5, 6 mm • TORX T10, T15 HEX 3, 4, 5, 6 mm • 1/4"

Code	Quantity (pcs)	
10022	22	6/24

**5 ANGLE ADAPTER**

• ОТВЕРТКА УГЛОВАЯ УНИВЕРСАЛЬНАЯ (ГНЕЗДА ДЛЯ БИТОВ 1/4") • WINKELSCHRAUBENDREHER UNIVERSAL 1/4"

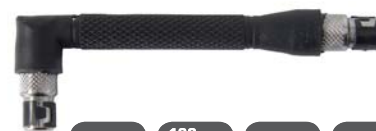

**100mm** **1/4"** **90°**

• Made from high quality materials • The handle has snaps to attach the bits securely • Reinforced (quenched) handles and arm • Protected with a plastic housing, ensuring reliable screwdriver grip

Code	Length (mm)		
31384	100	x	20/120

**2 15 PC BIT SET 1/4"**

• НАБОР 15 ШТ. БИТ, 1/4" • 15 STK. BIT-SATZ 1/4"



**1/4" S2 CrV HRC 58±2** **x15**

• The set includes: 4, 5, 6 PH 1, 2, 3 PZ 1, 2, 3 T 10, 15, 20, 25, 30 1/4" • Made of S2 high quality steel

Code	Quantity (pcs)		
10704	15	X	12/24





**1 10 PC BIT SETS 1/4"**

• НАБОРЫ 10 ШТ. БИТ 1/4" С МАГНИТНЫМ ПЕРЕХОДНИКОМ (АДАПТЕРОМ) • BITS-SET 1/4" - 10 STK.



x10 1/4" CrV HRC 58±2

• The set includes: 10699: ⊕ PH1 - 1 pcs., PH2 - 3 pcs. ⊕ PZ1 - 1 pcs., PZ2 - 3 pcs. ⊙ 6 mm - 1 pcs., 1/4" ⚭ 10700: ⊕ PH1, PH2, PH3 ⊕ PZ1, PZ2, PZ3 ⊕ 5, 6 mm ⊙ 4 mm, 1/4" ⚭

Code	Quantity (pcs)		
10699	10	x	12/72
10700	10	x	12/72

**2 23 PC SCREWDRIVER / SOCKET SET**

• НАБОР 23 ШТ. С УНИВЕРСАЛЬНОЙ ОТВЕРТКОЙ - ТРЕЩОТЧНЫМ КЛЮЧОМ • 23 ШТ. SCHRAUBENDREHER-/STECKSCHLÜSEL-SATZ



x23 CrV

• The set includes: • 1/4" ⚭ • ⊙ 60 mm • 1/4" ⊕ 3, 4, 5, 6 mm ⊕ PH0, 1, 2, 3 • 1/4" ⊕ 5, 6, 7, 8, 9, 10, 11, 12, 13 mm • Packed in a plastic box and cardboard packaging

Code	Quantity (pcs)	
10008	23	20

**3 KEYLESS CHUCK 1/4"**

• СВЕРЛИЛЬНЫЙ ПАТРОН САМОЗАЖИМНОЙ С ШЕСТИУГОЛЬНЫМ ХВОСТОВИКОМ 1/4" • SCHNELLSPANNBOHRFUTTER MIT SECHSKANTAUFNAHME 1/4"



max 1500 RPM 0,5-6,0mm 1/4"

• Made from high quality materials • Hex socket handle 1/4"

Code	Size (mm)		
31394	0.5-6.0	x	12/48

**4 7 PC BIT SET 1/4"**

• НАБОР 7 ШТ. БИТ 1/4" С МАГНИТНЫМ ПЕРЕХОДНИКОМ (АДАПТЕРОМ) • 7-TLG. SET BITS, 1/4"



x7 1/4" CrV HRC 58±2

• The set includes: ⊕ PH1, PH2 ⊕ PZ1, PZ2 ⊕ 5.5, 6.5 mm ⚭ 1/4" • Can be used as a screwdriver

Code	Quantity (pcs)	
10697	7	24/144

**5 RATCHET SCREWDRIVER WITH 12 BITS**

• ОТВЕРТКА С ТРЕЩОТЧНЫМ КЛЮЧОМ 12 ШТ. • SCHRAUBENDREHER MIT RATSCHKE - 12-TLG. SET



x12 CrV S2

• Handle with a 3-position ratchet, 6 double blades hidden in the handle: PH1 - flat 4 mm, PH2 - flat 5 mm, PZ1 - H 4 mm, PZ2 - H 5 mm, T10 - T15, T20 - T25

Code	Quantity (pcs)		
10028	6 x 2	x	24/96

**6 90° ANGLE ADAPTER WITH BEARINGS**

• АДАПТЕР УГЛОВОЙ ДЛЯ АККУМУЛЯТОРНЫХ ШУРУПОВЕРТОВ • WINKELADAPTER FÜR AKKUSCHRAUBER



max 13Nm 1/4" max 400 RPM

Code	Length (mm)		
31380	158	x	6/36

**7 COUPLERS FOR BITS 1/4"**

• АДАПТЕРЫ ДЛЯ БИТ - BIT-ADAPTER



1/2" 3/8" 1/4" CrV

Code	Square	Length (mm)	
10607	1/4"	25	50/600
10608	3/8"	30	25/400
10609	1/2"	38	25/200

**8 IMPACT SCREWDRIVER**

• ОТВЕРТКА УДАРНО-ПОВОРОТНАЯ • SCHLAGSCHRAUBER



5/16" 1/2" CrV S2

• Works in both directions: counterclockwise and clockwise • Screwdriver made from high quality CrV steel, bits made from S2 steel • PH1, 2, 3, Pz 5, 6, 8, 10, 12, 14 • Stored in a plastic box with a foam insert

Code	Quantity (pcs)	
10016	9	15



**1 "SOFT - TOUCH" SCREWDRIVERS**

• ОТВЕРТКИ С ПОКРЫТИЕМ "SOFT-TOUCH" • SCHRAUBENDREHER „SOFT-TOUCH“



- Two-component handle made from hard and soft, non-slip material
- Colour-coded handle:



Slot

- Bits 5 mm wide only in parallel



Code	Code on the suspension	Tip width (mm)	Length (mm)	
10151	ZR10151	2.5	63	12/600
10152	ZR10152	3.2	75	12/600
10158	ZR10158	3.2	100	12/600
10100	ZR10100	3.2	150	12/300
10153	ZR10153	5.0	100	12/240
10154	ZR10154	5.0	150	12/240
10103	ZR10103	5.0	200	12/240
10104	ZR10104	5.0	250	12/240
10150	ZR10150	6.0	38	12/300
10106	ZR10106	6.0	100	12/240
10155	ZR10155	6.0	150	12/240
10108	ZR10108	6.0	200	12/96
10109	ZR10109	6.0	250	12/96
10156	ZR10156	8.0	150	6/120
10112	ZR10112	9.5	200	6/96

Phillips (PH)



Code	Code on the suspension	Tip type	Length (mm)	
10080	ZR10080	PH 000	63	12/600
10081	ZR10081	PH 00	63	12/600
10161	ZR10161	PH 0	75	12/600
10083	ZR10083	PH 0	100	12/600
10084	ZR10084	PH 0	150	12/300
10162	ZR10162	PH 1	100	12/240
10086	ZR10086	PH 1	150	12/240
10087	ZR10087	PH 1	200	12/240
10088	ZR10088	PH 1	250	12/240
10168	ZR10168	PH 2	38	12/300
10163	ZR10163	PH 2	100	12/240
10164	ZR10164	PH 2	150	12/240
10092	ZR10092	PH 2	200	12/96
10093	ZR10093	PH 2	250	12/96
10165	ZR10165	PH 3	150	6/120
10167	ZR10167	PH 4	200	6/120

Pozidrive (PZ)



Code	Code on the suspension	Tip type	Length (mm)	
10171	ZR10171	PZ 0	75	12/600
10172	ZR10172	PZ 1	100	12/240
10173	ZR10173	PZ 2	38	12/300
10176	ZR10176	PZ 2	100	12/240
10174	ZR10174	PZ 2	150	12/240
10175	ZR10175	PZ 3	150	6/120

TORX T6-T9

TORX - Security T10-T40 - with an opening



Code	Code on the suspension	Tip type	Length (mm)	
10182	ZR10182	T6	75	12/240
10183	ZR10183	T7	75	12/240
10184	ZR10184	T8	75	12/300
10185	ZR10185	T9	75	12/300

SECURITY

10190	ZR10190	T10	100	12/240
10191	ZR10191	T15	100	12/300
10192	ZR10192	T20	100	12/300
10193	ZR10193	T25	100	12/144
10194	ZR10194	T27	100	12/144
10195	ZR10195	T30	100	12/144
10196	ZR10196	T40	100	12/144

**2 5 PC. "SOFT - TOUCH" SCREWDRIVER SET**

• НАБОР 5 ШТ. ОТВЕРТОК С ПОКРЫТИЕМ "SOFT-TOUCH" • SCHRAUBENDREHER „SOFT-TOUCH“ - 5-TLG. SET



- Two-component handle made from hard and soft, non-slip material
- The set includes:
  - $\ominus$  3.2 x 75, 5 x 100, 6 x 150 mm
  - $\oplus$  PH 1 x 75, 2 x 100 mm

Code	Quantity (pcs)		
10208	5	x	6/36



**3 68 PC. „SOFT-TOUCH“ SCREWDRIVER SET**

• НАБОР 68 ШТ. ОТВЕРТОК С ПОКРЫТИЕМ "SOFT-TOUCH" • SCHRAUBENDREHER - 68-TLG. SET



- Display set • Stand with 68 screwdrivers, with two-component handle made from hard and soft, non-slip material • The set includes:

- $\ominus$  2.5 x 63 - 6 pcs., 3.2 x 75 - 6 pcs., 5 x 100 - 4 pcs., 5 x 150 - 4 pcs., 6 x 150 - 4 pcs., 8 x 150 - 4 pcs.
- $\oplus$  PH 0 x 75 - 6 pcs., 1 x 100 - 4 pcs., 2 x 100 - 4 pcs., 2 x 150 - 4 pcs., 3 x 150 - 4 pcs.
- $\oplus$  PZ 0 x 75 - 6 pcs., 1 x 100 - 4 pcs., 2 x 100 - 4 pcs., 3 x 150 - 4 pcs.

Code	Quantity (pcs)	
10211	68	2

**4 6 PC. "SOFT - TOUCH" SCREWDRIVER SET**

• НАБОР 6 ШТ. ОТВЕРТОК С ПОКРЫТИЕМ "SOFT-TOUCH" • SCHRAUBENDREHER „SOFT-TOUCH“ - 6-TLG. SET



- Two-component handle made from hard and soft, non-slip material • Shelf hung on the wall
- The set includes:

- $\ominus$  3.2 x 75, 5 x 100, 6 x 150 mm
- $\oplus$  PH 0 x 75, 1 x 75, 2 x 100 mm

Code	Quantity (pcs)		
10207	6	x	6/36

**1 SCREWDRIVERS**

• ОТВЕРТКИ • SCHRAUBENDREHER



**SOFT TOUCH** **S2** **HRC 58±2**

- Works in both directions: counterclockwise and clockwise • Screwdriver made from quality CrV steel, bits made from S2 steel • PH1, 2, 3, PL 5, 6, 8, 10, 12, 14 • Stored in a plastic box with a foam insert



Slot 

Code on the suspension	Tip width (mm)	Length (mm)	
10901	2.5	65	12/240
10902	3.0	75	12/240
10903	5.0	100	12/240
10904	6.0	38	12/120
10905	6.0	100	12/120
10906	8.0	150	6/60



Phillips (PH) 

Code on the suspension	Tip type	Length (mm)	
10915	PH0	75	12/240
10916	PH1	100	12/120
10917	PH2	38	12/240
10918	PH2	100	12/120
10919	PH3	150	6/60



Pozidrive (PZ) 







Code on the suspension	Tip type	Length (mm)	
10925	PZ0	75	12/240
10926	PZ1	100	12/120
10927	PZ2	38	12/240
10928	PZ2	100	12/120
10929	PZ3	150	6/60

**2 SET OF SCREWDRIVERS AND BITS**

• НАБОР ОТВЕРТКИ И БИТ • SCHRAUBENDREHER- UND BITSATZ



**x37** **SOFT TOUCH** **S2** **HRC 58±2**

-   $\varnothing$  6x38, 5x75, 6x100, 8x150  $\varnothing$  PH1x75, 2x38, 2x100, 3x150
-  Bit Holder 1/4"x75 mm •   $\varnothing$  2.5x50, 3.0x50  $\varnothing$  PH0x50, PH0x50
-  T5x50, 6x50, 7x50, 8x50 •   $\varnothing$  T10, 15, 20, 25, 30, 40
-  H3, 4, 5, 6  $\varnothing$  4, 5, 6  $\varnothing$  PH1, 2, 3  $\varnothing$  PZ0, 1, 2, 3
- Two-component handle made of hard and soft anti-slip plastic • Magnetic, high-quality S2 steel bits • Wall mounting holes

Code	Quantity (pcs)	
10937	37	6/12

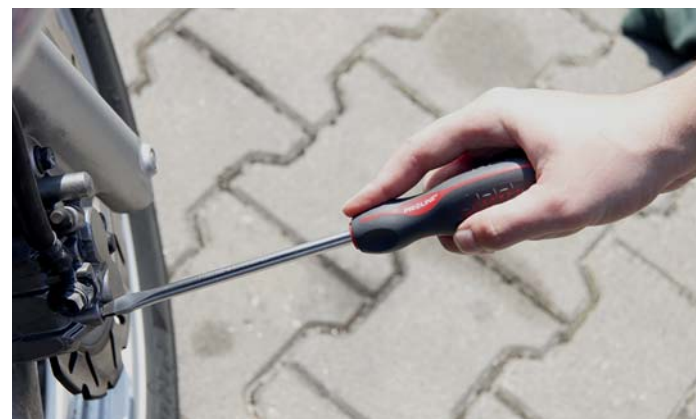

PROLINE  
LAHTI PRO  
MEGA  
JUCO  
OTHER BRANDS  
EMDI  
KLINGSPOR  
EXPRESS  
ACTION CAN  
TRYTON  
VALCAN

PROLINE

LAHTI PRO

MEGA

JUCO

OTHER BRANDS

ERDI

KUNGSFOR

EXPRESS

ACTION CAN

TRAYTON

VULCAN

**1 GO THROUGH SCREWDRIVERS**

• УДАРНЫЕ ОТВЕРТКИ • SCHLAGSCHRAUBENDREHE



• Two-component handle

Code	Tip width (mm)	Length (mm)		
10114	6	100	x	6/120
10115	6	150	x	6/120
10116	6	200	x	6/120
10117	6	250	x	6/120

Code	Tip width (mm)	Length (mm)		
10144	PH2	100	x	6/120
10145	PH2	150	x	6/120
10146	PH3	150	x	6/60
10147	PH3	200	x	6/60
10148	PH3	250	x	6/60

**2 ELECTRICIAN SCREWDRIVERS 1000 V**

• ЭЛЕКТРОТЕХНИЧЕСКИЕ ИЗОЛИРОВАННЫЕ ОТВЕРТКИ 1000В • ELEKTROSCHRAUBENDREHER 1000 V



• Handle made from non-slip material, ensuring safe grip

Code	Code on the suspension	Tip width (mm)	L (mm)	
10511	ZR10511	3.0	100	30/120
10513	ZR10513	4.0	100	25/100
10514	ZR10514	5.5	125	20/80
10515	ZR10515	6.5	150	15/60

Code	Code on the suspension	Tip type	L (mm)	
10516	ZR10516	PZ 0	100	30/120
10517	ZR10517	PZ 1	80	25/100
10518	ZR10518	PZ 2	100	20/80

**3 6 PC. ELECTRICIAN SCREWDRIVER 1000 V SET**

• НАБОР ЭЛЕКТРОТЕХНИЧЕСКИХ ИЗОЛИРОВАННЫХ ОТВЕРТОК 1000В ЧИСЛО ПРЕДМЕТОВ - 6 ШТ.



- Handle made from non-slip material, ensuring safe grip
- The set includes:
  - Ø 5.5 x 125, 4 x 100, 3 x 100 mm
  - Ø PH 1 x 80, 2 x 100 mm
- Voltage indicator 200 - 250 V, 140 mm
- Delivered in plastic box

Code	Quantity (pcs)		
10510	6	x	10

**4 ELECTRICIAN SCREWDRIVERS 1000 V**

• ЭЛЕКТРОТЕХНИЧЕСКИЕ ИЗОЛИРОВАННЫЕ ОТВЕРТКИ 1000В • ELEKTROSCHRAUBENDREHER 1000V - 6-TLG. SET

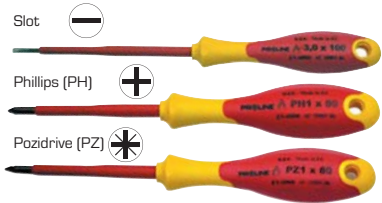

• Two-component non-slip handle

Code	Tip width (mm)/ Type	L (mm)	
10573	2.5	75	80/320
10574	3.0	100	60/240
10575	3.5	100	50/200
10576	4.0	100	50/200
10577	4.5	125	40/160
10578	5.5	125	30/120
10579	6.5	150	25/100

Code	Tip width (mm)/ Type	L (mm)	
10592	PH 0	60	80/320
10593	PH 1	80	40/160
10594	PH 2	100	30/120
10595	PZ 0	60	80/320
10596	PZ 1	80	40/160
10597	PZ 2	100	30/120

**5 DIGITAL VOLTAGE TESTER**

• ИНДИКАТОР НАПЯЖЕНИЯ • SPANNUNGSPRÜFER



- Metering range 12-250V, 50-60Hz • Contact test - to check direct and alternating current voltage in the display range of 12-36-55-110-220V • Induction test - voltage detection through insulation • Batteries not required

Code	Metering range (V)	Full length (mm)		
10542	12-250	125	x	20/500

**6 DIGITAL VOLTAGE TESTER**

• ИНДИКАТОР НАПЯЖЕНИЯ • SPANNUNGSPRÜFER



- Metering range 12-250V, 50-60Hz • Contact test - to check direct and alternating current voltage in the display range of 12-36-55-110-220V • Induction test - voltage detection through insulation • Batteries not required

Code	Metering range (V)	Full length (mm)		
10543	12-250	125	x	20/500

**7 DIGITAL VOLTAGE TESTER**

• ИНДИКАТОР НАПЯЖЕНИЯ • SPANNUNGSPRÜFER



- Metering range 12-250V, 50-60Hz • Contact test - to check direct and alternating current voltage in the display range of 12-36-55-110-220V • Induction test - voltage detection through insulation • Batteries not required

Code	Metering range (V)	Full length (mm)		
10544	12-250	160	x	6/120

**8 PRECISION SCREWDRIVER SET**

• НАБОР ОТВЕРТОК ДЛЯ ТОЧНОЙ МЕХАНИКИ И ЭЛЕКТРОНИКИ (ОТВЕРТКИ ЧАСОВЩИКА) • UHRMACHERSCHRAUBENDREHER

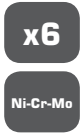

- Handle made from soft plastic, non-slip, ensuring additional rotational torque when screwing • Box structure ensures easy and convenient access to screwdrivers
- Perfect set for watchmakers, jewellers, electronic engineers and other specialists dealing with precision components and structures
- The set includes:
  - 10226 - Ø 1.4, 2.0, 2.4 mm - ⊕ PH00, PH0, PH1
  - 10225 - ⊕ TORX T4, T5, T6, T7, T9, T10

Code	Quantity (pcs)		
10225	6	x	25/100
10226	6	x	25/100

**9 PRECISION SCREWDRIVER SET**

• НАБОР ОТВЕРТОК ДЛЯ ТОЧНОЙ МЕХАНИКИ И ЭЛЕКТРОНИКИ (ОТВЕРТКИ ЧАСОВЩИКА) • UHRMACHERSCHRAUBENDREHER

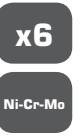

- Bits: special Ni-Cr-Mo steel, quenched
- Handy and non-slip handle • Perfect set for watchmakers, jewellers, electronic engineers and other specialists dealing with precision components and structures
- The set includes: 10226 - Ø 1.4, 2.0, 2.4 mm - ⊕ PH00, PH0, PH1

Code	Quantity (pcs)		
10229	6	x	20/100

**1 COMBINATION PLIERS**

• ПЛОСКОГУБЦЫ КОМБИНИРОВАННЫЕ • КОМБИЗАНГЕ

**CrV** **HRC**  
54±2

- Forged, quenched, made from high-grade tool steel
- Jaws for conductor cutting and shaping
- Two-composite, non-slip TPR handle

Code	Size (mm)		
28703	160	x	6/36
28704	180	x	6/36
28705	200	x	6/36

**4 LONG NOSE PLIERS**• ПЛОСКОГУБЦЫ ПРЯМЫЕ ПЛОСКО-КРУГЛЫЕ ГУБКИ  
• HALBRUNZANGE GRAD**CrV** **HRC**  
54±2

- Forged, quenched, made from high-grade tool steel
- Semi-circular jaws, with furrows, for shaping conductors, with lateral cutting edge
- Two-composite, non-slip TPR handle

Code	Size (mm)		
28706	160	x	6/36
28707	200	x	6/36

**7 COMBINATION PLIERS**

• ПЛОСКОГУБЦЫ КОМБИНИРОВАННЫЕ • КОМБИЗАНГЕ

**CrV** **HRC**  
54±2

- Forged, quenched, made from high-grade tool steel
- Flat jaws, with furrows, for shaping conductors
- Two-composite, non-slip TPR handle

Code	Size (mm)		
28470	160	x	12/72
28471	180	x	12/72
28472	200	x	12/72

**2 DIAGONAL SIDE CUTTERS**

• КУСАЧКИ БОКОВЫЕ • SEITENSCHNEIDER

**CrV** **HRC**  
54±2

- Forged, quenched, made from high-grade tool steel
- Jaws with high cutting power
- Two-composite, non-slip TPR handle

Code	Size (mm)		
28708	160	x	6/36
28709	180	x	6/36

**5 BENT NOSE PLIERS**

• ПЛОСКОГУБЦЫ ГНУТЫЕ ПЛОСКО-КРУГЛЫЕ ГУБКИ • HALBRUNZANGE ABGEWINKELT

**CrV** **HRC**  
54±2

- Forged, quenched, made from high-grade tool steel
- Semi-circular jaws, with furrows, curved for shaping conductors, with lateral cutting edge
- Two-composite, non-slip TPR handle

Code	Size (mm)		
28714	160	x	6/36
28715	200	x	6/36

**8 DIAGONAL SIDE CUTTERS**

• КУСАЧКИ БОКОВЫЕ • SEITENSCHNEIDER

**CrV** **HRC**  
54±2

- Forged, from high-grade chromium and vanadium steel, guaranteeing improved durability of the pliers, higher resistance to abrasion and offering improved technical parameters
- Two-composite, non-slip TPR handle

Code	Size (mm)		
28480	160	x	12/72
28481	180	x	12/72

**3 END CUTTING PLIERS**

• КУСАЧКИ ТОРЦЕВЫЕ • FRONTSCHNEIDER

**CrV** **HRC**  
54±2

- Forged, quenched, made from high-grade tool steel
- Jaws with high cutting power and strength
- Two-composite, non-slip TPR handle

Code	Size (mm)		
28713	160	x	6/36

**6 FLAT NOSE PLIERS**

• ПЛОСКОГУБЦЫ ПРЯМЫЕ ПЛОСКИЕ ГУБКИ • FLACHZANGE

**CrV** **HRC**  
54±2

- Forged, quenched, made from high-grade tool steel
- Flat jaws, with furrows, for shaping conductors
- Two-composite, non-slip TPR handle

Code	Size (mm)		
28716	160	x	6/36

**9 SNIPE NOSE PLIERS**• ПЛОСКОГУБЦЫ ПРЯМЫЕ ПЛОСКО-КРУГЛЫЕ ГУБКИ  
• HALBRUNZANGE GRADE**CrV** **HRC**  
54±2

- Forged, from high-grade chromium and vanadium steel, guaranteeing improved durability of the pliers, higher resistance to abrasion and offering improved technical parameters
- Two-composite, non-slip TPR handle

Code	Size (mm)		
28473	160	x	12/72
28475	200	x	12/72

PROLINE

LAHTI PRO

MEGA

JUCO

OTHER BRANDS

ERDI

KUNGSFOR

EXPRESS

ACTION CAN

TRYTON

VULCAN

**1 SNIPE NOSE PLIERS, BENT**

- ПЛОСКОГУБЦЫ ГНУТЫЕ С ПЛОСКО-КРУГЛЫМИ ГУБКАМИ
- HALBRUNDZANGE ABGEWINKELT



CrV HRC 54±2

- Forged, from high-grade chromium and vanadium steel, guaranteeing improved durability of the pliers, higher resistance to abrasion and offering improved technical parameters
- Two-composite, non-slip TPR handle

Code	Size (mm)		
28477	160	x	12/72
28479	200	x	12/72

**4 DIAGONAL SIDE CUTTERS - 1000 V**

- КУСАЧКИ БОКОВЫЕ (БОКОРЕЗЫ) 1000V
- SEITENSCHNEIDER 1000V



1000V CrV HRC 54±2

- Forged, from high-grade chromium and vanadium steel, guaranteeing improved durability of the pliers, higher resistance to abrasion and offering improved technical parameters
- Two-composite, non-slip TPR handle

Code	Size (mm)		
28526	160	x	12/72
28528	180	x	12/72

**7 WIRE STRIPING PLIERS 1000V**

- КЛЕЩИ (КУСАЧКИ) ДЛЯ СНЯТИЯ ИЗОЛЯЦИИ 1000V
- ABISOLIERZANGE



160 mm 1000V 0,5-5 mm² CrV HRC 40±2

- From chromium and vanadium steel
- Two-composite, non-slip TPR handle

Code	Wire cross-section (mm²)		
28519	0.5 - 5	x	12/72

**2 WIRE STRIPPING PLIERS**

- КЛЕЩИ (КУСАЧКИ) ДЛЯ СНЯТИЯ ИЗОЛЯЦИИ
- ABISOLIERZANGE



160 mm 0,5-5 mm² CrV HRC 40±2

- From chromium and vanadium steel
- Two-composite, non-slip TPR handle

Code	Wire cross-section (mm²)		
28486	0.5 - 5	x	12/72

**5 SNIPE NOSE PLIERS - 1000 V**

- ПЛОСКОГУБЦЫ ПРЯМЫЕ ПЛОСКО - КРУГЛЫЕ ГУБКИ 1000V
- HALBRUNDZANGE GRADE



1000V CrV HRC 54±2

- Forged, from high-grade chromium and vanadium steel, guaranteeing improved durability of the pliers, higher resistance to abrasion and offering improved technical parameters
- Two-composite, non-slip TPR handle

Code	Size (mm)		
28513	160	x	12/72
28515	200	x	12/72

**8 COMBINATION PLIERS**

- ПЛОСКОГУБЦЫ КОМБИНИРОВАННЫЕ - KOMBIZANGE



- Forged, made from high-grade tool steel
- Satin
- Ergonomic handles from high-grade material

Code	Size (mm)		
28750	160	x	6/60
28751	180	x	6/60
28752	200	x	6/60

**3 COMBINATION PLIERS - 1000 V**

- ПЛОСКОГУБЦЫ КОМБИНИРОВАННЫЕ 1000V
- KOMBIZANGE 1000V



1000V CrV HRC 54±2

- Forged, from high-grade chromium and vanadium steel, guaranteeing improved durability of the pliers, higher resistance to abrasion and offering improved technical parameters
- Two-composite, non-slip TPR handle

Code	Size (mm)		
28521	160	x	12/72
28522	180	x	12/72
28523	200	x	12/72

**6 SNIPE NOSE PLIERS, BENT - 1000 V**

- ПЛОСКОГУБЦЫ ГНУТЫЕ ПЛОСКО - КРУГЛЫЕ ГУБКИ 1000V
- HALBRUNDZANGE ABGEWINKELT 1000 V



1000V CrV HRC 54±2

- Forged, from high-grade chromium and vanadium steel, guaranteeing improved durability of the pliers, higher resistance to abrasion and offering improved technical parameters
- Two-composite, non-slip TPR handle

Code	Size (mm)		
28516	160	x	12/72
28518	200	x	12/72

**9 DIAGONAL SIDE CUTTERS**

- КУСАЧКИ БОКОВЫЕ (БОКОРЕЗЫ) • SEITENSCHNEIDER



- Forged, made from high-grade tool steel
- Satin
- Ergonomic handles from high-grade material

Code	Size (mm)		
28760	160	x	6/60

**1 END CUTTING PLIERS**

• КУСАЧКИ ТОРЦЕВЫЕ • FRONTSCHNEIDER



- Forged, made from high-grade tool steel
- High cutting power • Strong blades • Satin
- Ergonomic handles from high-grade material

Code	Size (mm)		
28765	160	x	6/60

**2 SNIPE NOSE PLIERS**

• ПЛОСКОГУБЦЫ ПРЯМЫЕ ПЛОСКО-КРУГЛЫЕ ГУБКИ (ДЛИННОГУБЦЫ) • HALBRUNDZANGE GRADE



- Semi-circular jaws with furrows • Side cutting edge • Satin • Ergonomic handles from high-grade material

Code	Size (mm)		
28770	160	x	6/60

**3 SNIPE NOSE PLIERS, BENT**

• ПЛОСКОГУБЦЫ ГНУТЫЕ ПЛОСКО-КРУГЛЫЕ ГУБКИ (ДЛИННОГУБЦЫ) • HALBRUNDZANGE ABGEWINKELT



- Forged, made from high-grade tool steel
- Semi-circular jaws with furrows • Side cutting edge • Satin • Ergonomic handles from high-grade material

Code	Size (mm)		
28771	160	x	6/60

**4 FLAT NOSE PLIERS**

• ПЛОСКОГУБЦЫ ПРЯМЫЕ ПЛОСКИЕ ГУБКИ • FLACHZANGE



- Forged, made from high-grade tool steel
- Short, flat jaws with furrows • Satin
- Ergonomic handles from high-grade material

Code	Size (mm)		
28772	160	x	6/60

**5 ROUND NOSE PLIERS**

• КРУЛЛОГУБЦЫ • RUNDZANGE



- Forged, made from high-grade tool steel
- Satin • Ergonomic handles from high-grade material

Code	Size (mm)		
28773	160	x	6/60

**6 COMBINATION PLIERS**

• ПЛОСКОГУБЦЫ КОМБИНИРОВАННЫЕ • КОМБИZANGE



- Forged, made from high-grade tool steel
- Satin • Two-composite, non-slip TPR handle

Code	Size (mm)		
28700	160	x	6/60
28701	180	x	6/60
28702	200	x	6/60

**7 DIAGONAL SIDE CUTTERS**

• КУСАЧКИ БОКОВЫЕ (БОКОРЕЗЫ) • SEITENSCHNEIDER



- Forged, made from high-grade tool steel
- Satin • Two-composite, non-slip TPR handle

Code	Size (mm)		
28710	160	x	6/60
28711	180	x	6/60
28712	200	x	6/60

**8 SNIPE NOSE PLIERS**

• ПЛОСКОГУБЦЫ ПРЯМЫЕ ПЛОСКО-КРУГЛЫЕ ГУБКИ (ДЛИННОГУБЦЫ) • HALBRUNDZANGE GRADE



- Forged, made from high-grade tool steel
- Semi-circular, elongated jaws with furrows
- Side cutting edge • Satin • Two-composite, non-slip TPR handle

Code	Size (mm)		
28720	160	x	6/60

**9 SNIPE NOSE PLIERS, BENT**

• ПЛОСКОГУБЦЫ ГНУТЫЕ ПЛОСКО-КРУГЛЫЕ ГУБКИ (ДЛИННОГУБЦЫ) • HALBRUNDZANGE GRADE



- Forged, made from high-grade tool steel
- Semi-circular, elongated jaws with furrows
- Side cutting edge • Satin • Two-composite, non-slip TPR handle

Code	Size (mm)		
28721	160	x	6/60

**10 FLAT NOSE PLIERS**

• ПЛОСКОГУБЦЫ ПРЯМЫЕ ПЛОСКИЕ ГУБКИ • FLACHZANGE



- Forged, made from high-grade tool steel
- Short, flat jaws with furrows • Satin • Two-composite, non-slip TPR handle

Code	Size (mm)		
28722	160	x	6/60

**1 MINI PLIERS**

• ПРЕЦИЗИОННЫЕ ПЛОСКОГУБЦЫ • ZANGE MICRO

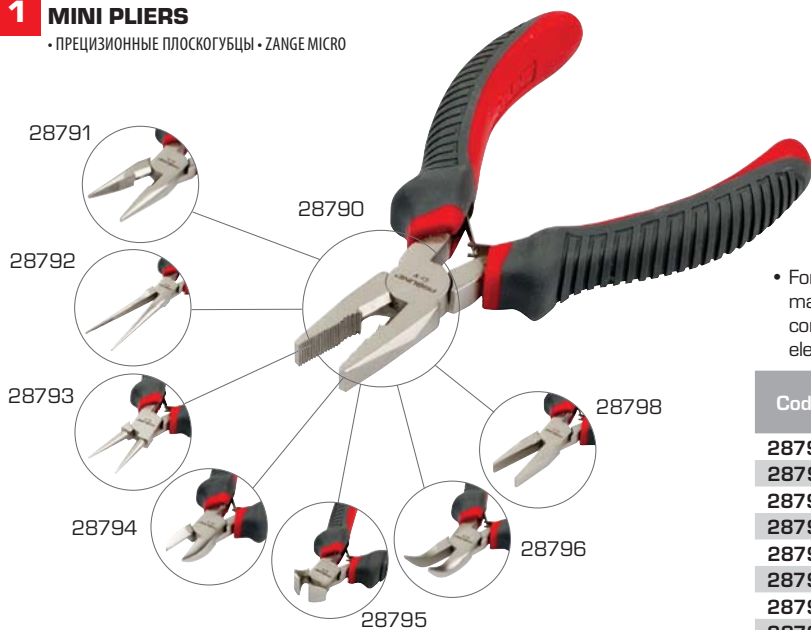

**HRC**  
60±5

**MICRO**

**CrV**

- Forged, quenched, made from high-grade tool steel
- Precise machining of jaws and edges
- Opened by return spring
- Two-composite, non-slip TPR handle
- Designed for precision works in electronic engineering, watchmaking, modelling, micromechanics etc.

Code	Type	Size (mm)		
<b>28790</b>	combination	120	x	6/36
<b>28791</b>	snipe nose	125	x	6/36
<b>28792</b>	elongated nose	150	x	6/36
<b>28793</b>	round nose	125	x	6/36
<b>28794</b>	diagonal side	115	x	6/36
<b>28795</b>	end cutting	105	x	6/36
<b>28796</b>	snipe nos, bent	125	x	6/36
<b>28798</b>	flat nose	125	x	6/36

**2 MINI PLIERS**

• ПРЕЦИЗИОННЫЕ ПЛОСКОГУБЦЫ • ZANGE MICRO

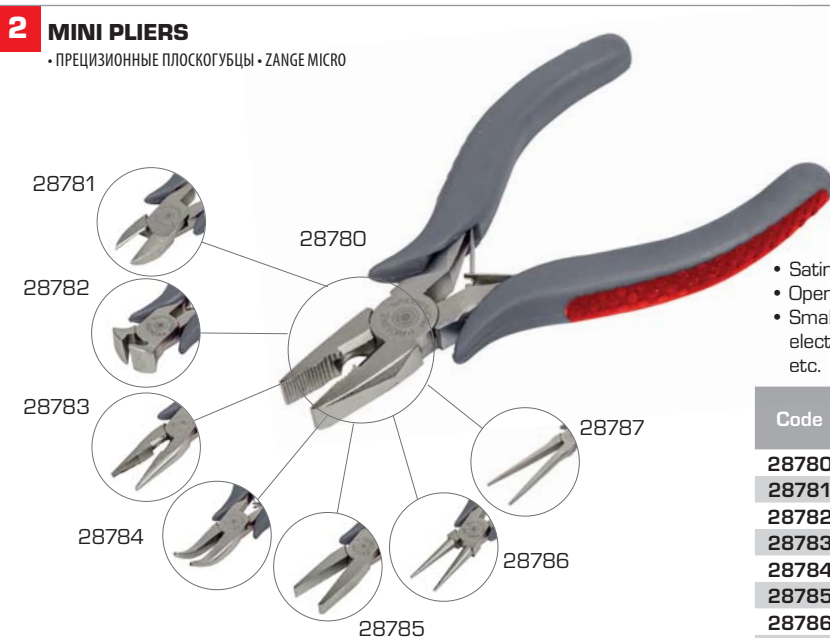

**MICRO**

- Satin
- Delivered on a card
- Precise machining of jaws and edges
- Opened by return spring
- Two-composite, non-slip TPR handle
- Small pliers from high-grade steel, designed for precision works in electronic engineering, watchmaking, modelling, micromechanics etc.

Code	Type	Size (mm)		
<b>28780</b>	combination	120	x	12/144
<b>28781</b>	diagonal side	110	x	12/144
<b>28782</b>	end cutting	110	x	12/144
<b>28783</b>	needle nose	120	x	12/144
<b>28784</b>	snipe nos, bent	120	x	12/144
<b>28785</b>	flat nose	120	x	12/144
<b>28786</b>	round nose	120	x	12/144
<b>28787</b>	elongated nose	120	x	12/144

**3 MINI PLIERS**

• ПРЕЦИЗИОННЫЕ ПЛОСКОГУБЦЫ • ZANGE MICRO

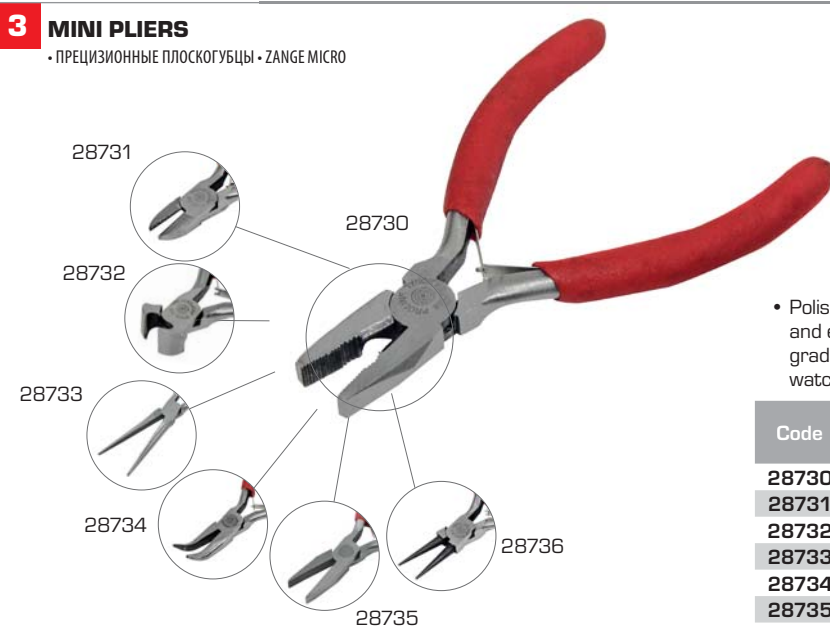

**MICRO**

- Polished
- Handles with flexible lining
- Precise machining of jaws and edges
- Opened by return spring
- Small pliers from high-grade steel, designed for precision works in electronic engineering, watchmaking, modelling, micromechanics etc.

Code	Type	Size (mm)		
<b>28730</b>	combination	120	x	12/144
<b>28731</b>	diagonal side	110	x	12/144
<b>28732</b>	end cutting	110	x	12/144
<b>28733</b>	needle nose	120	x	12/144
<b>28734</b>	snipe nos, bent	120	x	12/144
<b>28735</b>	flat nose	120	x	12/144
<b>28736</b>	round nose	120	x	12/144



**1 5 PC. MINI PLIERS SET**

• НАБОР 5 ШТ. ПРЕЦИЗИОННЫХ ПЛОСКОГУБЦЕВ • 5 STK. MINI-ZANGENSET

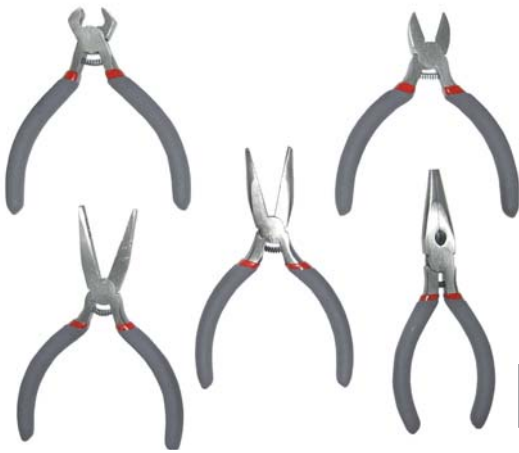
**x5** **120 mm** **HRC 50±2**

- Polished jaws
- Expanding springs
- Handles with flexible lining

Code	Size (mm)		
28745	120	x	6/24

**2 CABLE INSULATION SHEARS**• УНИВЕРСАЛЬНЫЕ НОЖИЦЫ ДЛЯ КАБЕЛЕЙ И ИЗОЛЯЦИИ  
• UNIVERSAL KABELSCHNEIDER UND ABISOLIERZANGE

- For cutting thin and soft wires, rubber, leather, plastic and thin metal sheet
- Serrated blade

Code	Size (mm)		
28370	140	x	12/72

**3 END CUTTING PLIERS**

• КУСАЧКИ ТОРЦЕВЫЕ • FRONTSCHNEIDER

**CrV**

- Forged
- Non-slip handle with rubber lining

Code	Size (mm)	
28556	160	6/60

**4 RABBIT PINCERS**

• КЛЕЩИ ШТУКАТУРНЫЕ • MONIERZANGE

**CrV**

- Non-slip handle with rubber lining

Code	Size (mm)	
28510	220	10/60
28512	250	10/60

**5 PINCERS**

• КЛЕЩИ ПЛОТНИЦКИЕ • KNEIFZANGE

**CrV**

- Forged
- Ground head
- Non-slip handle with rubber lining

Code	Size (mm)	
28568	200	10/60

**6 UNIVERSAL "TURBO" PLIERS**

• УНИВЕРСАЛЬНЫЕ ЩИПЦЫ TURBO • KOMBIZANGE TURBO



- Forged
- Satin
- Ground jaws
- Handle with rubber-covered lining

Code	Size (mm)		
28797	190	x	6/72

**7 CABLE CUTTER**

• НОЖИЦЫ ДЛЯ РЕЗКИ КАБЕЛЯ • KABELSCHNEIDER



Code	Size (mm)	Ø max (mm)		
28360	185	13	x	12/72

**8 CABLE CUTTING PLIERS**

• НОЖИЦЫ ДЛЯ РЕЗКИ КАБЕЛЯ • KABELSCHNEIDER



- Three-layer, non-slip handle

Code	Size (mm)	Ø max (mm)		
28316	160	6	x	6/60
28321	210	7	x	6/60

**9 HEAVY DUTY CABLE CUTTER**

• УСИЛЕННЫЕ НОЖИЦЫ ДЛЯ РЕЗКИ КАБЕЛЯ • KABELSCHNEIDER, VERSTÄRKT



- Three-layer, non-slip handle

Code	Size (mm)	Ø max (mm)		
28334	240	9	x	6/48

PROLINE

LAHTI PRO

MEGA

JUCO

OTHER BRANDS

ERDI

KLINGSPOR

EXPRESS

ACTION CAN

TRYTON

VULCAN

**1 CABLE CUTTER**

• НОЖИЦЫ РЫЧАЖНЫЕ ДЛЯ РЕЗКИ КАБЕЛЯ (КАБЕЛЕРЕЗ) • KABELSCHNEIDER



Code	Size (mm)	Max. wire cross-section (mm <sup>2</sup> )	
<b>28310</b>	380	125	20
<b>28311</b>	590	250	10
<b>28312</b>	780	500	5

**2 RATCHET CABLE CUTTER**

• НОЖИЦЫ СЕКТОРНЫЕ ДЛЯ РЕЗКИ КАБЕЛЯ • KNARREN-KABELSCHNEIDER



Code	Size (mm)	Max. wire cross-section (mm <sup>2</sup> )		
<b>28313</b>	245	300	x	20
<b>28314</b>	310	500	x	20



**1 CIRCLIP PLIERS - EXTERNAL STRAIGHT** PROLINE HD®

- ШИПЦЫ ДЛЯ СТОПОРНЫХ КОЛЕЦ НАРУЖНЫЕ - ПРЯМЫЕ • SICHERUNGSRINGZANGE FÜR AUSSENRINGE - GERADE



- Progressive, oxidized jaws
- Expanding spring
- Two-layer, non-slip handle

CrV HRC 44±2

Code	Size (mm)		
28619	180	x	6/60

**5 CIRCLIP PLIERS - EXTERNAL STRAIGHT**

- ШИПЦЫ ДЛЯ СТОПОРНЫХ КОЛЕЦ НАРУЖНЫЕ - ПРЯМЫЕ • SICHERUNGSRINGZANGE FÜR AUSSENRINGE - GERADE



- Nickel-plated jaws
- Expanding spring
- Two-layer, non-slip handle

CrV HRC 44±2

Code	Size (mm)		
28615	150	x	6/60
28617	175	x	6/60
28610	200	x	6/60

**2 CIRCLIP PLIERS - INTERNAL STRAIGHT** PROLINE HD®

- ШИПЦЫ ДЛЯ СТОПОРНЫХ КОЛЕЦ ВНУТРЕННИЕ-ПРЯМЫЕ • SICHERUNGSRINGZANGE FÜR INNENRINGE - GERADE



- Progressive, oxidized jaws
- Expanding spring
- Two-layer, non-slip handle

CrV HRC 44±2

Code	Size (mm)		
28629	180	x	6/60

**6 CIRCLIP PLIERS - INTERNAL STRAIGHT**

- ШИПЦЫ ДЛЯ СТОПОРНЫХ КОЛЕЦ ВНУТРЕННИЕ-ПРЯМЫЕ • SICHERUNGSRINGZANGE FÜR INNENRINGE - GERADE



- Nickel-plated jaws
- Expanding spring
- Two-layer, non-slip handle

CrV HRC 44±2

Code	Size (mm)		
28625	150	x	6/60
28627	175	x	6/60
28620	200	x	6/60

**3 CIRCLIP PLIERS - EXTERNAL BENT** PROLINE HD®

- ШИПЦЫ ДЛЯ СТОПОРНЫХ КОЛЕЦ НАРУЖНЫЕ-ВЫГНУТЫЕ • SICHERUNGSRINGZANGE FÜR AUSSENRINGE - GEBOGEN



- Progressive, oxidized jaws
- Expanding spring
- Two-layer, non-slip handle

CrV HRC 44±2

Code	Size (mm)		
28639	180	x	6/60

**7 CIRCLIP PLIERS - EXTERNAL BENT**

- ШИПЦЫ ДЛЯ СТОПОРНЫХ КОЛЕЦ НАРУЖНЫЕ-ВЫГНУТЫЕ • SICHERUNGSRINGZANGE FÜR AUSSENRINGE - GEBOGEN



- Nickel-plated jaws
- Expanding spring
- Two-layer, non-slip handle

CrV HRC 44±2

Code	Size (mm)		
28635	150	x	6/60
28637	175	x	6/60
28630	200	x	6/60

**4 CIRCLIP PLIERS - INTERNAL BENT** PROLINE HD®

- ШИПЦЫ ДЛЯ СТОПОРНЫХ КОЛЕЦ ВНУТРЕННИЕ-ВЫГНУТЫЕ • SICHERUNGSRINGZANGE FÜR INNENRINGE - GEBOGEN



- Progressive, oxidized jaws
- Expanding spring
- Two-layer, non-slip handle

CrV HRC 44±2

Code	Size (mm)		
28649	180	x	6/60

**8 CIRCLIP PLIERS - INTERNAL BENT**

- ШИПЦЫ ДЛЯ СТОПОРНЫХ КОЛЕЦ ВНУТРЕННИЕ-ВЫГНУТЫЕ • SICHERUNGSRINGZANGE FÜR INNENRINGE - GEBOGEN



- Nickel-plated jaws
- Expanding spring
- Two-layer, non-slip handle

CrV HRC 44±2

Code	Size (mm)		
28645	150	x	6/60
28647	175	x	6/60
28640	200	x	6/60

PROLINE  
LAHTI PRO  
MEGA  
JUNCO  
OTHER BRANDS  
ENDI  
KILINGSPOR  
EXPRESS  
ACTION CAN  
TRYTON  
VALDAN

PROLINE  
LAHTI PRO  
MEGA  
JUCO  
OTHER BRANDS  
ERDI  
KLINGSPOR  
EXPRESS  
ACTION CAN  
TRYTON  
VULCAN

**1 AUTOMATIC WIRE STRIPPER**  
 • КЛЕЩИ ДЛЯ УДАЛЕНИЯ ИЗОЛЯЦИИ САМОНАСТРАИВАЮЩИЕСЯ  
 • AUTOMATIK-ABISOLIERZANGE



**0,5-4 mm<sup>2</sup>**

• Cutting blade

Code	Wire cross-section (mm <sup>2</sup> )		
28404	8-28	x	10/50

**2 CABLE AND WIRE STRIPPER**  
 • СЪЕМНИК ИЗОЛЯЦИИ • ABISOLIERZANGE



**8-28 mm<sup>2</sup>**

• Handle with rubber inserts, ensuring improved grip • Spring cover

Code	Wire cross-section (mm <sup>2</sup> )		
28416	8 - 28	x	10/50

**3 CRIMPING PLIERS**  
 • ЩИПЦЫ ДЛЯ ЗАЖИМА НАКОНЕЧНИКОВ  
 • CRIMPZANGE



**20-10 AWG**  
0,5-5,0 mm<sup>2</sup> (10N)

**22-10 AWG**  
0,5-5,0 mm<sup>2</sup> (21N)

**HRC 67 ± 2**

Code	Wire cross-section (mm <sup>2</sup> )		
28493	0.5 - 6	x	50

**4 CRIMPING PLIERS**  
 • ЩИПЦЫ ДЛЯ ОПРЕССОВКИ ТЕЛЕФОННОГО КАБЕЛЯ  
 • CRIMPZANGE FÜR TELEFONSTECKER



**8P**

**4P 6P 8P**

**Sk5**

**HRC 63 ± 2**

Code	Wire cross-section		
28490	8P	x	8/48

**5 CRIMPING PLIERS**  
 • ЩИПЦЫ ДЛЯ ОПРЕССОВКИ ТЕЛЕФОННОГО КАБЕЛЯ  
 • CRIMPZANGE FÜR TELEFONSTECKER



**4P 6P 8P**

**4P 6P 8P**

**Sk5**

**HRC 63 ± 2**

• Replaceable jaws

Code	Wire cross-section		
28489	4P, 6P, 8P	x	8/48

**6 CRIMPING PLIERS**  
 • ЩИПЦЫ ДЛЯ ОПРЕССОВКИ ЭЛЕКТРИЧЕСКИХ КОНТАКТОВ  
 • CRIMPZANGE FÜR ISOLIERTE KABELSCHUHE



**22-10AWG**  
0,5-5,0 mm<sup>2</sup> (21N)

**HRC 45 ± 2**

• For end crimping 22-10 AWG • Rattle lever guarantees easy and repeatable end crimping

Code	Wire cross-section (mm <sup>2</sup> )		
28492	0.5 - 6	x	6/36

**7 CRIMPING PLIERS**  
 • ЩИПЦЫ ДЛЯ СНЯТИЯ ИЗОЛЯЦИИ И ОПРЕССОВКИ ТЕЛЕКОММУНИКАЦИОННОГО КАБЕЛЯ  
 • ABISOLIER- UND CRIMPZANGE FÜR STECKVERBINDER



**22-10 AWG**  
0,2-6 mm<sup>2</sup>

**HRC 55 ± 2**

• For removing wire insulation cross-section 0.2-6 mm<sup>2</sup> • Jaws for end crimping 22-10 AWG, 7-8mm

Code	Wire cross-section (mm <sup>2</sup> )		
28412	0.2 - 6	x	6/36



**8 AUTOMATIC WIRE STRIPPER**  
 • КЛЕЩИ ДЛЯ УДАЛЕНИЯ ИЗОЛЯЦИИ САМОНАСТРАИВАЮЩИЕСЯ  
 • AUTOMATIK-ABISOLIERZANGE



**0,5-6 mm<sup>2</sup>**

**175 mm**

• Adjustable force value of the cutting valve  
 • Adjustable insulation cutting depth

Code	Wire cross-section (mm <sup>2</sup> )		
28408	0.5 - 6	x	6/60

**1 ADJUSTABLE SPANNERS**

• РОЛИКОВЫЕ ТОРЦЕВЫЕ РАЗВОДНЫЕ КЛЮЧИ • VERSTELLSCHLÜSSEL

PROLINE HD®

CrV  
6140

- Forged, quenched
- Work range greater than the work range of standard spanners
- Special jaw structure ensuring reliable grip and adjustment to the nut shape
- Accurate worm wheel mechanism
- TPR handle covered with material resistant to grease and oil

Code	Size (mm)	Range (mm)		
29326	150	0 - 24	x	6/120
29328	200	0 - 29	x	6/60
29330	250	0 - 33	x	6/48
29332	300	0 - 38	x	6/24

**2 ADJUSTABLE SPANNERS**

• РОЛИКОВЫЕ ТОРЦЕВЫЕ РАЗВОДНЫЕ КЛЮЧИ • VERSTELLSCHLÜSSEL



CrV

- Forged, quenched
- Accurate worm wheel mechanism
- Metric scale
- Nut sockets: two hexagonal and one ring one
- Two-composite, non-slip TPR handle

Code	Size (mm)	Range (mm)		
29319	150	0 - 25	x	6/48
29320	200	0 - 30	x	6/36
29321	250	0 - 35	x	6/24
29322	300	0 - 40	x	6/24

**3 ADJUSTABLE SPANNERS**

• РОЛИКОВЫЕ ТОРЦЕВЫЕ РАЗВОДНЫЕ КЛЮЧИ • VERSTELLSCHLÜSSEL



- Forged
- Satin
- Metric scale
- Ground jaws
- Handle with rubber-covered lining

Code	Size (mm)	Range (mm)	
29306	150	0 - 19	6/120
29308	200	0 - 24	6/72
29310	250	0 - 28	6/48
29312	300	0 - 34	6/24
29315	375	0 - 43	6/12
29318	450	0 - 52	4/8
29324	600	0 - 62	1/4

**4 LOCKING PLIERS**

• КЛЕЩИ САНТЕХНИЧЕСКИЕ MORSE'A • GRIPZANGE

PROLINE HD®



CrMo

HRC  
42±2

- Rounded, quenched jaws
- Screw controlling jaw opening
- Release lever
- Non-slip, two-colour handle

Code	Size (mm)		
28217	180	x	6/36
28227	240	x	6/36

**5 LOCKING PLIERS**

• КЛЕЩИ САНТЕХНИЧЕСКИЕ MORSE'A • GRIPZANGE

PROLINE HD®



CrMo

HRC  
42±2

- Elongated, quenched jaws
- Screw controlling jaw opening
- Release lever
- Non-slip, two-colour handle

Code	Size (mm)		
28220	220	x	6/36

PROLINE

LANITI PRO

MEGA

JUCO

OTHER BRANDS

ERDI

KUNGSFOR

EXPRESS

ACTION CAN

TRAYTON

VULCAN

**1 LOCKING PLIERS**

- КЛЕЩИ САНТЕХНИЧЕСКИЕ MORSE'A
- GRIPZANGE



**CrMo**

**HRC**  
42±2

- Elongated, quenched jaws
- Screw controlling jaw opening
- Release lever

Code	Size (mm)		
28222	225	x	6/36

**2 LOCKING PLIERS**

- КЛЕЩИ САНТЕХНИЧЕСКИЕ MORSE'A - GRIPZANGE



**CrMo**

**HRC**  
55±2

- Rounded, quenched jaws
- Screw controlling jaw opening
- Release lever

Code	Size (mm)		
28214	180	x	6/36

**3 LOCKING PLIERS**

- КЛЕЩИ САНТЕХНИЧЕСКИЕ MORSE'A
- GRIPZANGE



**CrV**

- Rounded, machined locking jaws
- Screw controlling jaw opening
- Chromium-plated

Code	Size (mm)		
28215	250	x	6/60

**4 LOCKING PLIERS**

- КЛЕЩИ САНТЕХНИЧЕСКИЕ MORSE'A
- GRIPZANGE



**CrMo**

**HRC**  
42±2

- Flat, quenched jaws
- Screw controlling jaw opening
- Release lever

Code	Size (mm)		
28240	180	x	6/36
28245	250	x	6/36

**5 LOCKING PLIERS**

- КЛЕЩИ САНТЕХНИЧЕСКИЕ MORSE'A - GRIPZANGE



- Rounded, machined locking jaws
- Screw controlling jaw opening
- Release lever
- Blackened

Code	Size (mm)		
28219	180	x	6/60
28226	250	x	6/24

**6 WATERPUMP PLIERS**

- КЛЕЩИ САНТЕХНИЧЕСКИЕ
- ROHRZANGE



Ø max.  
2"

250mm

**CrV**

**DIN**  
5743

- Polished

Code	Size (mm)	Pipes diameter	
28581	250	2"	6/60

**7 WATERPUMP PLIERS**

- КЛЕЩИ САНТЕХНИЧЕСКИЕ - ROHRZANGE



Ø max.  
1 1/2"

250mm

**CrV**

- Blackened

Code	Size (mm)	Pipes diameter	
28580	250	1 1/2"	10/50

**8 PROFILE FORMING PLIERS**

- ЩИПЦЫ ДЛЯ ФОРМОВКИ ПРОФИЛЕЙ - ПРЯМЫЕ
- PROFILZANGE - GERADE



**210 mm**

- Designed for manual section forming
- Flat jaws, knurled inside

Code	Jaw dimensions (mm)		
28381	80 x 35	x	2/12
28382	150 x 35	x	2/12

**9 PROFILE FORMING PLIERS - BENT**

- ЩИПЦЫ ДЛЯ ФОРМИРОВАНИЯ ПРОФИЛЕЙ - ВЫГНУТЫЕ
- PROFILZANGE - GEBOGEN



**205 mm**

- Designed for manual section forming
- Flat jaws, knurled inside

Code	Jaw dimensions (mm)		
28380	80 x 35	x	2/12

**10 PROFILE CONNECTION PLIERS**

- ЩИПЦЫ ДЛЯ СОЕДИНЕНИЯ ПРОФИЛЕЙ
- PROFIL-VERBINDUNGSZANGE



**GR15**

**Al-Ti**  
A380

max  
2x0,8mm

**HRC**  
57±2

- For joining steel sections with the thickness up to 0.8 mm
- Helpful when joining sections for gypsumboard
- Punch and matrix made from GR15 steel
- Head made from AlTi A380 alloy

Code	Size (mm)		
28390	275	x	6/24

**1 WATERPUMP PLIERS**

• ТРУБНЫЕ КЛЕЩИ • ROHRZANGE



• Forged

Code	Size (mm)	Pipes diameter	
29720	320	1"	24
29721	420	1 1/2"	12
29722	550	2"	6

**2 WATERPUMP PLIERS**

• ТРУБНЫЕ КЛЕЩИ • ROHRZANGE



• Forged

Code	Size (mm)	Pipes diameter	
29710	320	1"	24
29711	420	1 1/2"	12
29712	550	2"	6

**3 WATERPUMP PLIERS**

• ТРУБНЫЕ КЛЕЩИ • ROHRZANGE



• Forged

Code	Size (mm)	Pipes diameter	
29701	320	1"	24
29705	420	1 1/2"	12
29706	550	2"	6

**4 STILLSON WRENCHES**

• КЛЮЧИ РАЗВОДНЫЕ ТИПА STILLSON • STILLSON-ROHRZANGEN



• Forged • Increased wrench cross-section, offering very high durability  
• Handle covered with non-slip rubber-coated material

Code	Size (cal/mm)	Pipes diameter	
29008	8"/200	1"	6/48
29010	10"/250	1 1/2"	6/24
29012	12"/300	2"	6/18
29014	14"/350	2"	6/12
29018	18"/450	2 1/2"	2/8
29024	24"/600	3"	2/4
29036	36"/900	3 1/2"	2

**5 PIPE BENDER**

• ТРУБОГИБ  
• ROHRBIEGER



• Bender for copper, aluminum pipes, bending range 180°

Code	Diameter (mm)		
67215	6/8/10	x	20

**6 PEX-AL-PEX PIPE CONNECTION CRIMPING TOOL**

• ТРУБНЫЙ ЗАЖИМ PEX-AL-PEX  
• PEX-AL-PEX ROHRVERBINDUNGS-CRIMPZANGE



• Crimping tool for PEX-AL-PEX connections, 4 dies included • 360° swivel head • Dies available for purchase separately (PROLINE 67241-16 mm, 16242-20 mm, 16243-26 mm, 16244-32 mm)

Code	Diameter (mm)		
67240	16/20/26/32	x	2

**7 ADDITIONAL FORM FOR THE PEX-AL-PEX CRIMPING TOOL**

• ЗАПАСНАЯ МАТРИЦА ДЛЯ ЗАЖИМА PEX-AL-PEX • ZUSÄTZLICHE FORM FÜR DIE PEX-AL-PEX CRIMPZANGE



• For the 67240 crimping tool

Code	Diameter (mm)	
67241	16	25/100
67242	20	25/100
67243	26	25/100
67244	32	25/100

PROLINE

LAHTI PRO

MEGA

JUCO

OTHER BRANDS

ERDI

KUNGSFOR

EXPRESS

ACTION CAN

TRYTON

VULCAN

**1 STEP WRENCH WITH RATCHET**  
 • СТУПЕНЧАТЫЙ КЛЮЧ ДЛЯ РЕЗЬБОВЫХ СОЕДИНЕНИЙ С ХРАПОВЫМ МЕХАНИЗМОМ • STUFENSCHLÜSSEL MIT KNARRE



**1/2" CrV 36T**

- Inside ratchet

Code	Size (mm)	Box	Box
18187	3/8" (9,6mm), 7/16" (11,6mm), 1/2" (12,5mm), 5/8" (16,4mm), 13/16" (21mm)	x	5/20

**2 STEP WRENCH**  
 • СТУПЕНЧАТЫЙ КЛЮЧ ДЛЯ РЕЗЬБОВЫХ СОЕДИНЕНИЙ • STUFENSCHLÜSSEL



**1/2" CrV**

Code	Size (mm)	Box	Box
18188	3/8" (9,6mm), 7/16" (11,6mm), 1/2" (12,5mm), 5/8" (16,4mm), 13/16" (21mm)	x	20/100



**3 FLARING TOOL SET**  
 • НАБОР ДЛЯ РУЧНОГО РАСШИРЕНИЯ ТРУБ • SATZ FÜR ERWEITERUNG VON ROHREN



**3-19 mm**

- For installation works and in automotive sector

Code	Diameter (mm)	Box
67208	3 - 19	10

**4 FLARING TOOL SETS**  
 • НАБОРЫ ДЛЯ РУЧНОГО РАСШИРЕНИЯ ТРУБ • SATZ FÜR ERWEITERUNG VON ROHREN



**1/2" CrV**

- For installation works and in automotive sector

Code	Diameter (mm)	BOX	Box
67209	19 - 25	x	18
67210	22 - 28	x	18

**5 PIPE VICES**  
 • ЗАЖИМНЫЕ ТИСКИ ДЛЯ ТРУБ • ROHRSCHRAUBSTÖCKE



- Designed for plumbing works

Code	Ø max (mm)	BOX	Box
67211	76	x	4
67212	90	x	2

**6 TELESCOPIC PIPE CUTTER - QUICK ADJUSTMENT**  
 • ТРУБОРЕЗ БЫСТРОРЕГУЛИРУЕМЫЙ • TELESKOP-ROHRABSCHNEIDER MIT SCHNELLVERSTELLUNG





**6-67 mm**

- Designed for copper, aluminium and brass pipes • Four steel guide rollers
- Ratchet gear enabling quick adjustment to the pipe diameter • High-quality tempered cutting disc

Code	Pipes diameter (mm)	Box	Box
17214	6 - 67	x	5/20

**7 PIPE CUTTER**  
 • ТРУБОРЕЗ • ROHRABSCHNEIDER

**3-30 mm**

- For copper and aluminium pipes
- Foldable, steel deburring tool • High-quality tempered cutting disc

Code	Pipes diameter (mm)	Box	Box
17211	3 - 30	x	10/50



**1 TELESCOPIC PIPE CUTTERS**

- ТРУБОРЕЗЫ ТЕЛЕКОПИЧЕСКИЕ
- TELESKOP-ROHRABSCHNEIDER



- Designed for copper, aluminium and brass pipes
- Retractable, steel deburring tool
- High-quality tempered cutting disc

Code	Pipes diameter (mm)		
17212	6 - 35	x	10/50
17213	6 - 42	x	5/50

**2 MINI PIPE CUTTER**

- ТРУБОРЕЗ МИНИ • MINI-ROHRABSCHNEIDER



- For thin-walled copper and aluminium pipes
- High-quality tempered cutting disc

Code	Pipes diameter (mm)		
17210	3 - 22	x	10/50

**3 PIPE CUTTER**

- ТРУБОРЕЗ • ROHRABSCHNEIDER



- Designed for copper, aluminium and plastic pipes
- Ideal for cutting pipes hard to be reached

Code	Diameter (mm)		
17215	15	x	12/72
17216	22	x	12/72
17217	28	x	6/48

**4 PVC PIPE CUTTER**

- ТРУБОРЕЗ ДЛЯ ПЛАСТМАССОВЫХ ТРУБ
- ROHRABSCHNEIDER



- Ratchet gear increasing blade pressure
- Blade made from stainless steel
- Body made from aluminium alloy

Code	Ø max (mm)		
17201	42	x	10/50

**5 PIPE CUTTER**

- ТРУБОРЕЗ ДЛЯ ПЛАСТМАССОВЫХ ТРУБ
- ROHRABSCHNEIDER FÜR KUNSTSTOFFROHRE



- Ratchet gear facilitating cutting
- Body made from aluminium cast

Code	Ø max (mm)		
17200	42	x	10/30

**6 MULTILAYER PIPE SHEARS**

- НОЖИЦЫ ДЛЯ МНОГОСЛОЙНЫХ ТРУБ
- ROHRABSCHNEIDER FÜR VERBUNDROHRE



- For multi-layered pipes of PE-X/Al/PE-RT Typee
- Blade made from stainless steel
- Body made from aluminium alloy

Code	Ø max (mm)		
17202	36	x	10/50

**7 RATCHET PIPE THREADING SETS**

- НАБОРЫ ВИНТОНАРЕЗНЫХ ГОЛОВОК
- ROHRGEWINDESCHNEIDER MIT RATSCH



- Two-way ratchet (16 teeth)
- Aluminium ratchet casing
- Two-part handle

Code	Quantity (pcs)	Heads		
67206	6	1/2", 3/4", 1", 1 1/4"	x	4
67207	7	3/8", 1/2", 3/4", 1", 1 1/4"	x	4

**8 DEBURRER**

- ГРАТОСНИМАТЕЛЬ • ROHRABSCHNEIDER



Code	Blade diameter (mm)		
67201	3,2	x	50/150

**9 BLADES FOR DEBURRER**

- ЛЕЗВИЯ ДЛЯ ГРАТОСНИМАТЕЛЯ • ENTGRATER-KLINGEN



- Universal size fits deburrer Proline 67201

Code	Diameter (mm)		
67202	3,2	x	12/144

# PNEUMATIC TOOLS AND ACCESSORIES

filters

guns:

- blowing
- for pumping
- painting
- washing

impact wrenches

oilers

pneumatic hoses

reducers

quick-release nozzles

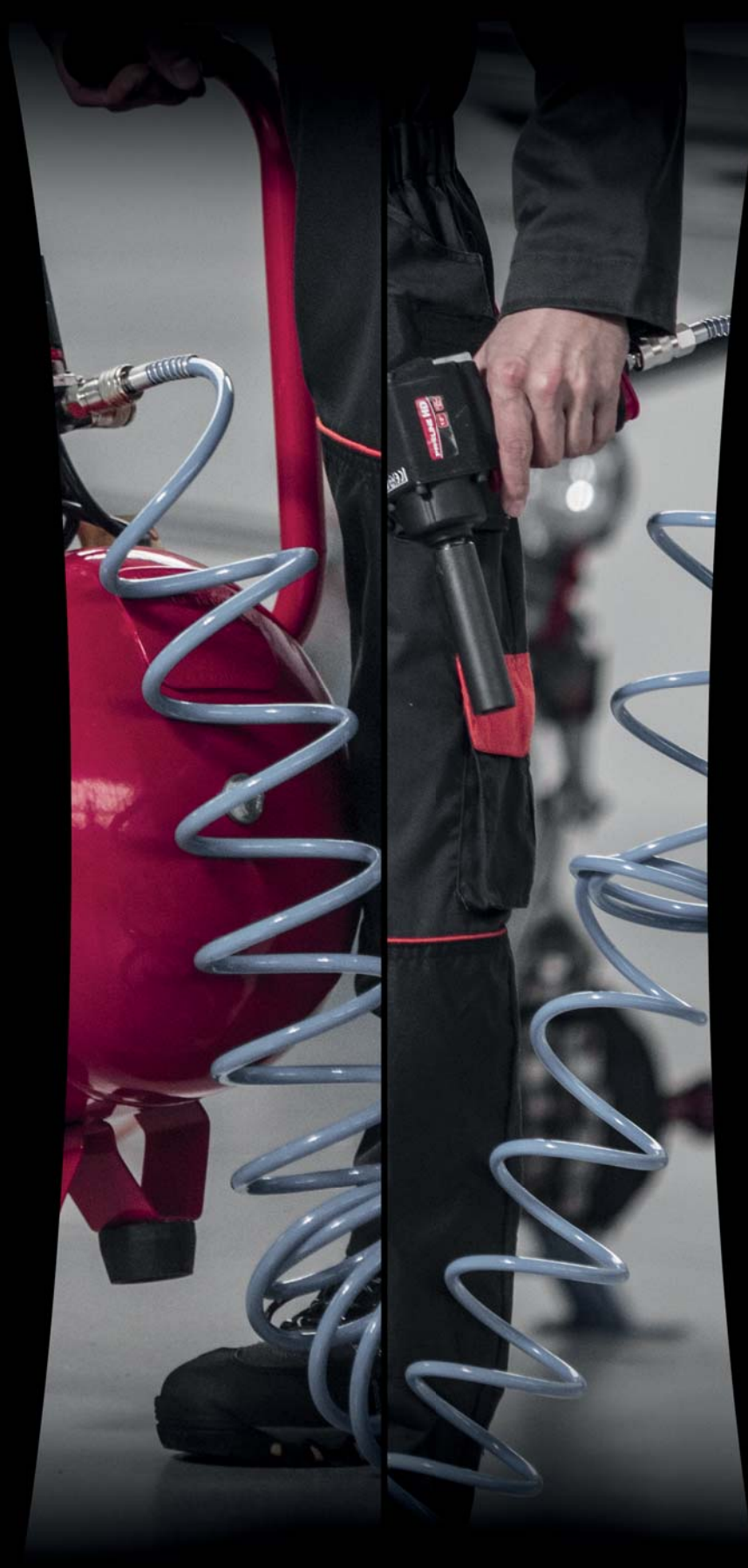

# PNEUMATIC TOOLS AND ACCESSORIES

**Pneumatic tools** are a great alternative to their electric counterparts, but they are also much more effective: **they offer more power and weigh less.**

## How to choose a spray painting gun?

The basic division of spray guns on a functional level includes the following:

An HP (high-pressure) spray painting gun – the oldest available pressure painting technology. A small amount of paint is ejected under high pressure through a small opening, forming what is called a pattern. HP guns cause significant paint spraying, which causes a significant amount of the paint to be used.

HVLP (low pressure) spray paint gun – has more openings in the nozzle than an HP gun, which means the pressure is lower, but the amount of paint sprayed increases. An HVLP gun has the advantage in that it uses less paint, but such a gun requires a stronger compressor. An LVLP spray painting gun (low pressure with low material consumption) – A type of gun that combines the advantages of HP and HVLP guns, i.e. it works at a low pressure, with low compressed air consumption, guaranteeing low paint loss.

An LVLP spray painting gun is the most modern tool for painting. The gun needs to be selected, so that it allows efficient work with the compressor-tank combination you have. A high-pressure gun can be used with smaller tanks combined with efficient compressors, while an HVLP gun requires a very large tank, first and foremost.

The gun needs to be selected, so that it allows efficient working with the compressor-tank combination you have. Smaller tanks combined with powerful compressors allow the use of a high-pressure gun, while an HVLP gun requires a very capacious tank, above all.



## PNEUMATIC TOOL INSTALLATION DIAGRAM

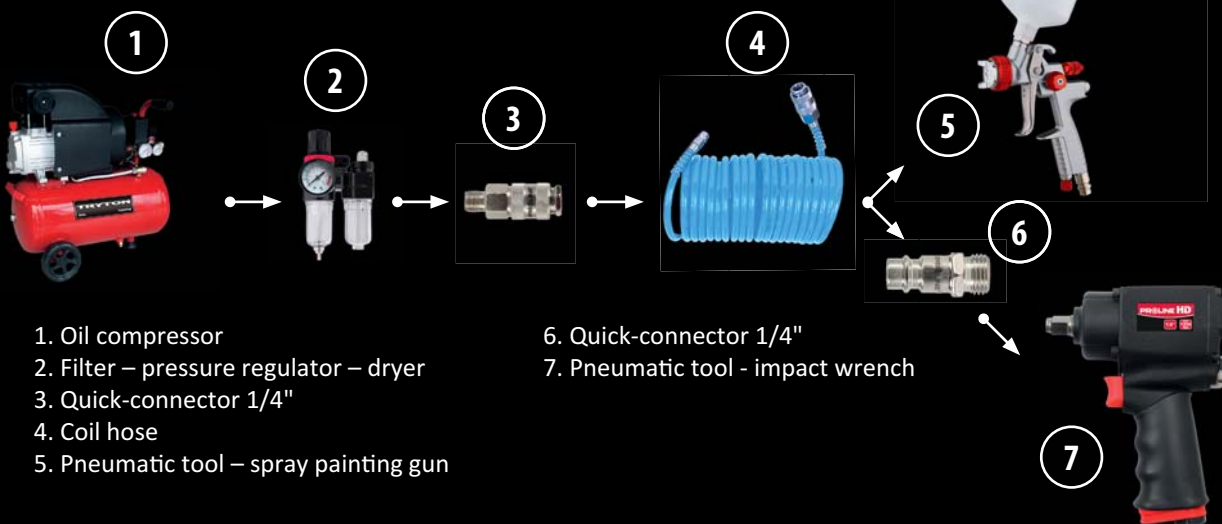

# ПНЕВМАТИЧЕСКИЕ ИНСТРУМЕНТЫ И ПРИНАДЛЕЖНОСТИ

**Пневматические инструменты** являются не только отличной альтернативой электрическим аналогам, но также намного эффективнее: **они более мощные и весят меньше.**

## Как выбрать пистолет-краскораспылитель?

По функциональному уровню основной ассортимент краскораспылителей включает:

Пистолет-краскораспылитель высокого давления (HP) - наиболее старая из доступных технологий для покраски под давлением. Небольшое количество краски выбрасывается под высоким давлением через небольшое отверстие, образуя "узор". В пистолетах высокого давления используется сильное распыление, что приводит к высокому расходу краски.

Пистолет-краскораспылитель низкого давления (HVLP) имеет большее количество отверстий в форсунке, чем в пистолете HP, что означает, что давление ниже, но количество распыляемой краски увеличивается. Преимущество пистолета HVLP состоит в том, что он использует меньше краски, но для такого пистолета требуется более мощный компрессор. Пистолет-краскораспылитель низкого давления с низким расходом материала (LVLP) - это пистолет, в котором сочетаются преимущества пистолетов HP и HVLP, т.е. он работает при низком давлении, с низким расходом сжатого воздуха, гарантируя малые небольшие краски.

Пистолет-краскораспылитель LVLP - наиболее современный инструмент для покраски. Пистолет выбирают таким образом, чтобы он позволял эффективно работать с имеющейся комбинацией компрессор-бак. Пистолет высокого давления может использоваться с небольшими резервуарами в сочетании с мощными компрессорами, в то время как для пистолета HVLP прежде всего требуется очень большой бак.

Пистолет выбирают таким образом, чтобы он позволял эффективно работать с имеющейся комбинацией компрессор-бак. Пистолет высокого давления может использоваться с небольшими резервуарами в сочетании с мощными компрессорами, в то время как для пистолета HVLP прежде всего требуется очень большой бак.



## СХЕМА УСТАНОВКИ ПНЕВМАТИЧЕСКОГО ИНСТРУМЕНТА



# PNEUMATISCHE WERKZEUGE UND ZUBEHÖR

**Pneumatische Werkzeuge** stellen eine hervorragende alternative zu ihren elektrischen Gegenstücken dar, aber Sie sind auch viel effizienter als diese: **sie bieten mehr Leistung und weniger Gewicht.**

## Wie wählt man eine Lackierpistole aus?

Die grundlegende Aufteilung der Lackierpistolen auf funktionaler Ebene umfasst Folgendes:



Eine HP (Hochdruck) Lackierpistole – die älteste verfügbare Technologie des Drucklackierens. Eine kleine Farbmenge wird unter hohem Druck durch eine kleine Öffnung ausgestoßen, wodurch ein sogenanntes Muster entsteht. Hochdruckpistolen verursachen ein erhebliches Sprühen der Farbe, was dazu führt, dass eine erhebliche Menge der Farbe verwendet wird.

Eine HVLP (reduzierter Druck) Lackierpistole – verfügt über mehr Öffnungen in der Düse als eine HP-Lackierpistole, was einen reduzierten Druck zur Folge hat, aber die versprühte Farbmenge wird gesteigert. Eine HVLP-Lackierpistole hat den Vorteil, dass sie weniger Farbe verwendet, aber sie benötigt einen stärkeren Kompressor. Eine LVLP-Lackierpistole (niedrigerer Druck und niedrigerer Materialverbrauch) – diese Art der Lackierpistolen kombiniert die zwei Vorteile der HP- und HVLP-Lackierpistolen, d. h. sie wird mit einem reduzierten Druck betrieben, mit einem niedrigen Druckluftverbrauch und sie generiert niedrige Farbverluste.

Die LVLP-Lackierpistole ist das modernste Werkzeug für Lackierarbeiten. Die Lackierpistole muss so ausgewählt werden, dass sie zusammen mit dem Kompressor und Tank eine effizient Arbeit ermöglicht. Eine Hochdruckpistole kann zusammen mit mit kleineren Tanks und effizienteren Kompressoren verwendet werden, während eine HVLP-Lackierpistole vor allem einen sehr großen Tank benötigt.

Die Lackierpistole muss so ausgewählt werden, dass sie zusammen mit dem Kompressor und Tank eine möglichst effiziente Arbeit sicherstellt. Kleinere Tanks ermöglichen zusammen mit einem effizienten Kompressor die Verwendung einer Hochdruckpistole, während eine Pistole des Typs HVLP einen sehr großen Tank erfordert.



## INSTALLATIONS DIAGRAMM FÜR PNEUMATISCHE WERKZEUGE

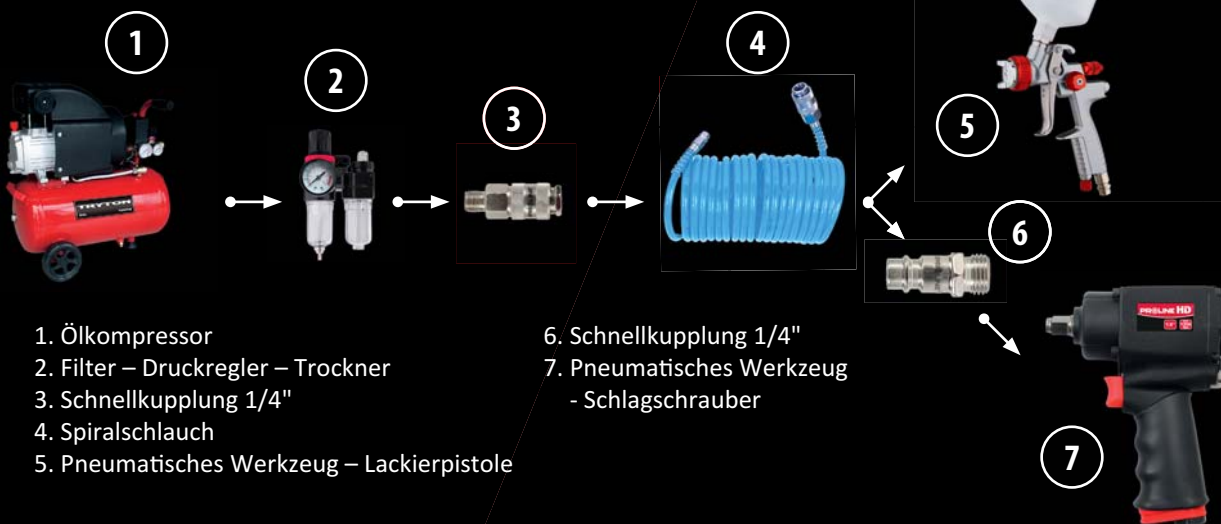

PROLINE

LAHTI PRO

MEGA

JUCCO

OTHER BRANDS

ERDI

KLINGSPOR

EXPRESS

ACTION CAN

TRYTON

VULCAN

**1 AIR IMPACT WRENCH**

• УДАРНЫЙ КЛЮЧ ПНЕВМАТИЧЕСКИЙ • DRUCKLUFT-SCHLAGSCHRAUBER

PROLINE HD®

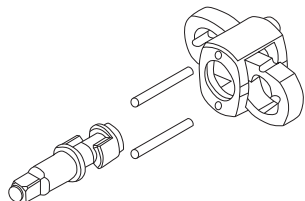

**6,3 bar**

**135 l/min**

**TWIN HAMMER**



**1,42kg LIGHT WEIGHT**

**108mm COMPACT SIZE**



**1/2"**

**max 678 Nm**

- Designed for professional use • Compact size and low weight • Impact mechanism with a double hammer clutch • Left / right direction switch
- 3 tightening torque values and 3 loosening ones • Downward air inlet in the handle • Aluminium body, rubber-coated handle • All-purpose quick coupling 1/4"

Code	Square	Max. torque [Nm]	
66471	1/2"	678	10

**2 AIR IMPACT WRENCH**

• УДАРНЫЙ КЛЮЧ ПНЕВМАТИЧЕСКИЙ • DRUCKLUFT-SCHLAGSCHRAUBER

PROLINE HD®

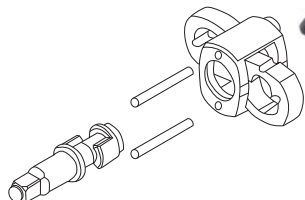

**6,3 bar**

**144 l/min**

**TWIN HAMMER**



**1,80kg LIGHT WEIGHT**

**141mm COMPACT SIZE**



**1/2"**

**max 1356 Nm**

- Designed for professional use • Very high torque with a small-size spanner • Impact mechanism with a double hammer clutch • Rotation change-over switch (leftwards / rightwards) • 3 tightening torque values and 3 loosening ones • Downward air inlet in the handle
- Aluminium body, rubber-coated handle

Code	Square	Max. torque [Nm]	
66472	1/2"	1356	10



**1 AIR IMPACT WRENCH**

• УДАРНЫЙ КЛЮЧ ПНЕВМАТИЧЕСКИЙ • DRUCKLUFT-SCHLAGSCHRAUBER



**1/2"** **max 610 Nm**  
**6,2 bar** **169 l/min** **TWIN HAMMER** **(R/L)** **1,50kg LIGHT WEIGHT** **125mm COMPACT SIZE** **CE**  
**n.:10000/min**

- Compact size and low weight
- All-purpose quick coupling 1/4"
- Aluminium body, rubber-coated handle
- Downward air inlet in the handle
- 3 tightening torque values and 3 loosening ones
- Left / right direction switch
- Impact mechanism with a double hammer clutch

Code	Square	Max. torque (Nm)	
66370	1/2"	610	10

**3 AIR IMPACT WRENCH**

• УДАРНЫЙ КЛЮЧ ПНЕВМАТИЧЕСКИЙ • DRUCKLUFT-SCHLAGSCHRAUBER



**1/2"** **max 1145 Nm**  
**6,2 bar** **198 l/min** **TWIN HAMMER** **(R/L)** **CE**  
**n.:7000/min**

- Impact mechanism with a double hammer clutch
- All-purpose quick coupling 1/4"
- Composite body, rubber-coated handle
- Downward air inlet in the handle
- 3 tightening torque values and 1 loosening ones
- Left / right direction switch

Code	Square	Max. torque (Nm)	
66372	1/2"	1145	10

**2 AIR IMPACT WRENCH**

• УДАРНЫЙ КЛЮЧ ПНЕВМАТИЧЕСКИЙ • DRUCKLUFT-SCHLAGSCHRAUBER



**1/2"** **max 810 Nm**  
**6,3 bar** **133 l/min** **TWIN HAMMER** **(R/L)** **CE**  
**n.:7000/min**

- Designed for basic workshop works
- Impact mechanism with a double hammer clutch
- Rotation change-over switch (leftwards / rightwards)
- 3 tightening torque values and 1 loosening ones
- Downward air inlet in the handle
- Composite body, rubber-coated handle
- All-purpose quick coupling 1/4"

Code	Square	Max. torque (Nm)	
66371	1/2"	810	10

**4 INFLATING GUN**

• ПИСТОЛЕТ ДЛЯ НАКАЧКИ КОЛЕС • AUFBLASPISTOLE



**max 8 BAR** **440 mm** **AL** **1/4"** **CE**

- Designed for professional use
- Manometer with a diameter of 80 mm

Code	Max. air pressure (bar)		
66349	8	x	10/20

PROLINE

LAHTI PRO

MEGA

JUCO

OTHER BRANDS

ERDI

KLINGSPOR

EXPRESS

ACTION CAN

TRAYTON

VULCAN

**1 AIR KIT**

• ПНЕВМОКОМПЛЕКТ • LUFTKIT



x5 CE

- Includes:
- Gravity feed paint gun (66345)
- Inflating gun (66346)
- Washing gun (66347)
- Blowgun (66348)
- PU recoil air hose (66350)

Code	Quantity of items		
66343	5	x	5/10

**3 WASHING GUN**

• МОЕЧНЫЙ ПИСТОЛЕТ • WASCHPISTOLE



max 8 BAR 0,9l AL 1/4" CE

Code	Max. air pressure (bar)		
66347	8	x	10/20

**2 INFLATING GUN**

• ПИСТОЛЕТ ДЛЯ НАКАЧКИ КОЛЕС • AUFBLASPISTOLE



max 8 BAR 440 mm AL 1/4" CE

- Manometer with a diameter of 60 mm

Code	Max. air pressure (bar)		
66346	8	x	10/40

**4 AIR BLOW GUN**

• ПРОДУВОЧНЫЙ ПИСТОЛЕТ • DRUCKLUFT-BLASPISTOLE



max 8 BAR AL 1/4" CE

- Additional 215 mm nozzle

Code	Max. air pressure (bar)		
66348	8	x	20/40



**1 SUCTION SPRAY GUN**

• КРАСКОРАСПЫЛИТЕЛЬНЫЙ ПИСТОЛЕТ С НИЖНИМ БАЧКОМ • SAUGSPRITZPISTOLE



HP max 4 BAR 1,5mm 0,85l AL 1/4" CE

Code	Max. air pressure (bar)		
66344	4	x	5/10

**3 GRAVITY SPRAY GUN**

• КРАСКОРАСПЫЛИТЕЛЬНЫЙ ПИСТОЛЕТ С ВЕРХНИМ БАЧКОМ • SCHWERKRAFTSPRITZPISTOLE



HVLP max 4 BAR 1,5mm 410 l/min 0,6l 1/4" CE

• Low-pressure gun for advanced users

Code	Max. air pressure (bar)	BOX	
66361	4	x	20

**2 GRAVITY SPRAY GUN**

• КРАСКОРАСПЫЛИТЕЛЬНЫЙ ПИСТОЛЕТ С ВЕРХНИМ БАЧКОМ • SCHWERKRAFTSPRITZPISTOLE



HP max 4 BAR 1,5mm 0,6l AL 1/4" CE

Code	Max. air pressure (bar)		
66345	4	x	5/10

**4 GRAVITY SPRAY GUN**

• КРАСКОРАСПЫЛИТЕЛЬНЫЙ ПИСТОЛЕТ С ВЕРХНИМ БАЧКОМ • SCHWERKRAFTSPRITZPISTOLE



LVMP max 3 BAR 1,3mm 250 l/min 0,6l 1/4" CE

• Low-pressure gun with low material consumption for professional use

Code	Max. air pressure (bar)	BOX	
66362	3	x	20

PROLINE

LAHTI PRO

MEGA

JUCCO

OTHER BRANDS

ENDI

KLINGSPOR

EXPRESS

ACTION CAN

TRITON

VULCAN

PROLINE

LAHTI PRO

MEGA

JUCCO

OTHER BRANDS

ERDI

KLINGSPOR

EXPRESS

ACTION CAN

TRYTON

VULCAN

### 1 SPIRAL AIR HOSE

• ПНЕВМАТИЧЕСКИЙ СПИРАЛЬНЫЙ ШЛАНГ  
• SPIRALLUFTSCHLAUCH



• Made of polyurethane (PU), which is much more flexible than polyethylene (PE)

Code	Diameter (mm)	Length (m)	Kolor	Box
66350	5 x 8	5	■	4 / 16
66351	5 x 8	10	■	4 / 16
66352	5 x 8	15	■	4 / 16
66353	6.5 x 10	5	■	4 / 16
66354	6.5 x 10	10	■	4 / 16
66355	6.5 x 10	15	■	4 / 16
66356	8 x 12	5	■	4 / 16
66357	8 x 12	10	■	4 / 16
66358	8 x 12	15	■	4 / 16

### 3 FILTER - WATER TRAP

• ФИЛЬТР – УДАЛИТЕЛЬ ВЛАГИ • FILTER - WASSERABSCHIEDER



• Designed for spray guns to ensure clean and dry air

Code	Max. air pressure (bar)	Box	Box
66381	12	x	10/50

### 2 LUBRICATOR

• СМАЗЫВАЮЩЕЕ УСТРОЙСТВО • SCHMIERVORRICHTUNG



• Designed for impact wrenches and other pneumatic tools to ensure proper lubrication

Code	Max. air pressure (bar)	Box	Box
66382	8	x	10/50

### 4 REDUCER

• РЕДУКТОР • REDUZIERSTÜCK



• Designed for regulating the working pressure supplied to pneumatic tools

Code	Max. air pressure (bar)	Box	Box
66383	12	x	50

**1 REDUCER - FILTER UNITS**

• РЕДУКТОР С ФИЛЬТРОМ • REDUZIERSTÜCK - FILTEREINHEITEN



66384



66386

max 9.3 BAR +60°C -10°C 1/4"

• Designed for regulating the working pressure, and providing clean and dry air for pneumatic tools

Code	Max. air pressure (bar)	Filter capacity (cm³)	BOX	▢
66384	9,3	15	x	50
66386	9,3	60	x	50

**2 REDUCER - FILTER - LUBRICATOR UNITS**

• РЕДУКТОР С ФИЛЬТРОМ И СМАЗЫВАЮЩИМ УСТРОЙСТВОМ • REDUZIERSTÜCK - FILTER - SCHMIEREINHEITEN



66385



66387

max 9.3 BAR +60°C -10°C 1/4"

• Designed for regulating the working pressure, and ensuring clean and dry air, as well as proper lubrication of pneumatic tools

Code	Max. air pressure (bar)	Filter capacity (cm³)	Lubricator capacity (cm³)	BOX	▢
66385	9,3	15	25	x	50
66387	9,3	60	30	x	25



PROLINE

LAHTI PRO

MEGA

JUCO

OTHER BRANDS

ERDI

KLINGSPOR

EXPRESS

ACTION CAN

TRYTON

VULCAM

**1 AIR QUICK-COUPERS (FEMALE - EXTERNAL THREAD)**

- ПНЕВМАТИЧЕСКИЙ БЫСТРОРАЗЪЕМНЫЙ ШТУЦЕР (ТИПА «МАМА» - С ВНЕШНЕЙ РЕЗЬБОЙ)
- LUFTSCHNELLKUPPLUNGEN (WEIBLICH - AUSSENGEWINDE)



Code	External thread		
66300	1/4"	x	50 / 100
66301	3/8"	x	50 / 100
66302	1/2"	x	50 / 100

**3 AIR QUICK-COUPERS (FEMALE - FOR AIR HOSE)**

- ПНЕВМАТИЧЕСКИЙ БЫСТРОРАЗЪЕМНЫЙ ШТУЦЕР (ТИПА «МАМА» - ДЛЯ ШЛАНГА)
- LUFTSCHNELLKUPPLUNGEN (WEIBLICH - FÜR LUFTSCHLAUCH)



Code	Hose diameter [mm]		
66306	6	x	50 / 100
66307	8	x	50 / 100
66308	10	x	50 / 100
66309	12	x	50 / 100

**2 AIR QUICK-COUPERS (FEMALE - INTERNAL THREAD)**

- ПНЕВМАТИЧЕСКИЙ БЫСТРОРАЗЪЕМНЫЙ ШТУЦЕР (ТИПА «МАМА» - С ВНУТРЕННЕЙ РЕЗЬБОЙ)
- LUFTSCHNELLKUPPLUNGEN (WEIBLICH - INNENGEWINDE)



Code	External thread		
66303	1/4"	x	50 / 100
66304	3/8"	x	50 / 100
66305	1/2"	x	50 / 100

**4 AIR QUICK-COUPERS (FEMALE - FOR AIR HOSE)**

- ПНЕВМАТИЧЕСКИЙ БЫСТРОРАЗЪЕМНЫЙ ШТУЦЕР (ТИПА «МАМА» - ДЛЯ ШЛАНГА)
- LUFTSCHNELLKUPPLUNGEN (WEIBLICH - FÜR LUFTSCHLAUCH)



Code	Hose diameter [mm]		
66320	5 x 8	x	10 / 60
66321	6.5 x 10	x	10 / 60
66322	8 x 12	x	10 / 60

**1 AIR QUICK-COUPERS (MALE - EXTERNAL THREAD)**

- ПНЕВМАТИЧЕСКИЙ БЫСТРОРАЗЪЕМНЫЙ ШТУЦЕР (ТИПА «ПАПА» - С ВНЕШНЕЙ РЕЗЬБОЙ)
- LUFTSCHNELLKUPPLUNGEN (MÄNNLICH - AUSSENGEWINDE)



Code	External thread		
66310	1/4"	x	50 / 100
66311	3/8"	x	50 / 100
66312	1/2"	x	50 / 100

**3 AIR QUICK-COUPERS (MALE - FOR AIR HOSE)**

- ПНЕВМАТИЧЕСКИЙ БЫСТРОРАЗЪЕМНЫЙ ШТУЦЕР (ТИПА «ПАПА» - ДЛЯ ШЛАНГА)
- LUFTSCHNELLKUPPLUNGEN (MÄNNLICH - FÜR LUFTSCHLAUCH)



Code	Hose diameter (mm)		
66316	6	x	50 / 100
66317	8	x	50 / 100
66318	10	x	50 / 100
66319	12	x	50 / 100

**2 AIR QUICK-COUPERS (MALE - INTERNAL THREAD)**

- ПНЕВМАТИЧЕСКИЙ БЫСТРОРАЗЪЕМНЫЙ ШТУЦЕР (ТИПА «ПАПА» - С ВНУТРЕННЕЙ РЕЗЬБОЙ)
- LUFTSCHNELLKUPPLUNGEN (MÄNNLICH - INNENGEWINDE)



Code	External thread		
66313	1/4"	x	50 / 100
66314	3/8"	x	50 / 100
66315	1/2"	x	50 / 100

**4 AIR QUICK-COUPERS (MALE - FOR AIR HOSE)**

- ПНЕВМАТИЧЕСКИЙ БЫСТРОРАЗЪЕМНЫЙ ШТУЦЕР (ТИПА «ПАПА» - ДЛЯ ШЛАНГА)
- LUFTSCHNELLKUPPLUNGEN (MÄNNLICH - FÜR LUFTSCHLAUCH)



Code	Hose diameter (mm)		
66330	5 x 8	x	10 / 60
66331	6.5 x 10	x	10 / 60
66332	8 x 12	x	10 / 60

PROLINE

LAHTI PRO

MEGA

JUNO

OTHER BRANDS

ENDI

KLINGSPOR

EXPRESS

ACTION CAN

TRAYTON

VILDAN

# CONSTRUCTION, DECORATING, IRONWORKING TOOLS



axes  
clamps  
files  
foam and caulking guns  
hammers  
knives  
measuring tools  
painting accessories  
saws  
shovels  
spades  
taps  
trowels  
vices  
and many others

**1 QUICK-CHANGE RETRACTABLE TRIMMING KNIFE**

- УНИВЕРСАЛЬНЫЙ НОЖ С ТРАПЕЦИЕВИДНЫМ ВЫДВИЖНЫМ ЛЕЗВИЕМ
- UNIVERSALMESSER MIT KLAPPBARER TRAPEZKLINGE



- Automatic blade replacement without knife opening
- Blade drum

Code	Blade (mm)		
30310	62	x	6/72

**2 RETRACTABLE TRIMMING KNIFE**

- УНИВЕРСАЛЬНЫЙ НОЖ С ТРАПЕЦИЕВИДНЫМ ВЫДВИЖНЫМ ЛЕЗВИЕМ
- UNIVERSALMESSER MIT KLAPPBARER TRAPEZKLINGE

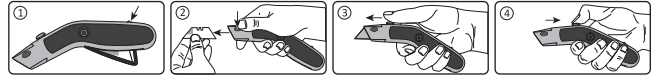

- Fast blade replacement
- Metal body
- Blade drum

Code	Blade (mm)		
30311	62	x	6/72

**3 FIX BLADE TRIMMING KNIFE**

- УНИВЕРСАЛЬНЫЙ НОЖ С ТРАПЕЦИЕВИДНЫМ ЛЕЗВИЕМ
- UNIVERSALMESSER MIT TRAPEZKLINGE



- Trapezoidal, permanent blade
- Metal body with blade lock
- Blade drum

Code	Blade (mm)		
30307	62	x	6/72

**5 AUTO RETRACTING TRIMMING KNIFE**

- УНИВЕРСАЛЬНЫЙ БЕЗОПАСНЫЙ НОЖ С ТРАПЕЦИЕВИДНЫМ ЛЕЗВИЕМ
- UNIVERSAL SICHERHEITSMESSER MIT TRAPEZKLINGE



- Trapezoidal blade automatically hiding once the button is released
- Metal body

Code	Blade (mm)		
30315	62	x	6/72

**7 RETRACTABLE TRIMMING KNIFE**

- УНИВЕРСАЛЬНЫЙ НОЖ С ТРАПЕЦИЕВИДНЫМ ВЫДВИЖНЫМ ЛЕЗВИЕМ
- UNIVERSALMESSER MIT KLAPPBARER TRAPEZKLINGE



- Metal body with non-slip, soft, rubber inserts
- Drum for spare blades with a snap

Code	Blade (mm)		
30301	62	x	12/96

**8 RETRACTABLE KNIVES**

- УНИВЕРСАЛЬНЫЙ НОЖ С СЕГМЕНТИРОВАННЫМ ЛЕЗВИЕМ
- UNIVERSALMESSER MIT ABBRECKKLINGE



- Retractable, broken blade
- Metal body with blade lock

Code	Blade (mm)		
30028	18	x	12/96
30029	9	x	12/288

**4 RETRACTABLE TRIMMING KNIFE**

- УНИВЕРСАЛЬНЫЙ НОЖ С ТРАПЕЦИЕВИДНЫМ ВЫДВИЖНЫМ ЛЕЗВИЕМ
- UNIVERSALMESSER MIT KLAPPBARER TRAPEZKLINGE



- Fast blade replacement
- Metal body with non-slip rubber inserts
- Drum for spare blades

Code	Blade (mm)		
30300	62	x	12/96

**6 RETRACTABLE TRIMMING KNIFE**

- УНИВЕРСАЛЬНЫЙ НОЖ С ТРАПЕЦИЕВИДНЫМ ВЫДВИЖНЫМ ЛЕЗВИЕМ
- UNIVERSALMESSER MIT KLAPPBARER TRAPEZKLINGE



- Metal body with blade lock

Code	Blade (mm)		
30305	62	x	12/96

**9 RETRACTABLE KNIFE**

- УНИВЕРСАЛЬНЫЙ НОЖ С СЕГМЕНТНЫМ ЛЕЗВИЕМ
- UNIVERSALMESSER MIT ABBRECKKLINGE



- Retractable, broken blade
- Metal body with blade lock

Code	Blade (mm)		
30078	18	x	12/96

PROLINE

LAHTI PRO

MEGA

JUCO

OTHER BRANDS

ERDI

KLINGSPOR

EXPRESS

ACTION CAN

TRYTON

VULCAN

**1 RETRACTABLE KNIFE**

- УНИВЕРСАЛЬНЫЙ НОЖ С СЕГМЕНТНЫМ ЛЕЗВИЕМ
- UNIVERSALMESSER MIT ABBRECKKLINGE



- Retractable, broken blade • Metal body with blade lock

Code	Blade (mm)		
30079	9	x	12/144

**2 RETRACTABLE KNIFE**

- УНИВЕРСАЛЬНЫЙ НОЖ С СЕГМЕНТНЫМ ЛЕЗВИЕМ
- UNIVERSALMESSER MIT ABBRECKKLINGE



- Retractable, broken blade • Plastic body with non-slip rubber insert and precise blade lock
- Automatic loading of the next blade

Code	Blade (mm)		
30033	18	x	12/144

**3 RETRACTABLE KNIFE**

- УНИВЕРСАЛЬНЫЙ НОЖ С СЕГМЕНТНЫМ ЛЕЗВИЕМ
- UNIVERSALMESSER MIT ABBRECKKLINGE



- Retractable, broken blade • Plastic body with non-slip rubber insert and blade lock

Code	Blade (mm)		
30039	9	x	12/288

**4 RETRACTABLE KNIFE**

- УНИВЕРСАЛЬНЫЙ НОЖ С СЕГМЕНТНЫМ ЛЕЗВИЕМ
- UNIVERSALMESSER MIT ABBRECKKLINGE



- Retractable, broken blade • Plastic body with non-slip rubber insert and precise blade lock

Code	Blade (mm)		
30038	18	x	12/144

**5 FOLDING TRIMMING KNIFE**

- НОЖ СО СКЛАДЫВАЕМЫМ ТРАПЕЦЕИДАЛЬНЫМ ЛЕЗВИЕМ
- UNUNIVERSALMESSER MIT KLAPPBARER TRAPEZKLINGE



- Quick blade replacement • Aluminium body
- „Back-lock” blade lock • Belt hook • Nylon casing with velcro

Code	Blade (mm)		
30030	62	x	12/48

**6 FOLDING KNIFE**

- НОЖ УНИВЕРСАЛЬНЫЙ СКЛАДНОЙ • UNUNIVERSALKLAPPMESSER



- Stainless steel • Aluminium body • „Liner-lock” • Belt hook • Nylon casing with velcro

Code	Blade (mm)		
30040	80	x	12/48

**7 FOLDING KNIFE**

- УНИВЕРСАЛЬНЫЙ СКЛАДНОЙ НОЖ • UNIVERSALMESSER



- Stainless steel • Mahogany covers
- Polished handle

Code	Blade (mm)		
30090	80	x	12/96

**8 FOLDING KNIVES**

- УНИВЕРСАЛЬНЫЕ СКЛАДНЫЕ НОЖИ • UNIVERSALMESSER



- Stainless steel • Polished handle

Code	Blade (mm)		
30092	50	x	10/100
30093	60	x	10/100
30094	70	x	10/100

**9 ELECTRICIAN'S KNIVES**

- МОНТЁРСКИЕ НОЖИ • ELEKTRIKERMESSER



30095



30096



Code	Blade (mm)		
30095	70	x	10/100
30096	65	x	10/100

**10 INSULATION KNIFE**

- НОЖ ДЛЯ РЕЗКИ СТРОИТЕЛЬНОЙ ИЗОЛЯЦИИ
- ISOLATIONSMESSER



Code	Blade (mm)		
31400	335	x	10/60

**11 SCISSORS**

- НОЖИЦЫ • SCHERE



- Two-component ergonomic handle

Code	Length (mm)		
30082	140	x	30/60
30084	220	x	30/60



### 1 RETRACTABLE KNIFE BLADES

• СЕГМЕНТНЫЕ ЛЕЗВИЯ • AUSWECHSELBARE ABBRECHKLING



x10 Sk5

- 10 blades in a box with a dispenser
- Thickness: 18 mm - 0.5 mm, 9 mm - 0.4 mm

Code	Blade (mm)		
31003	9	-	20/800
31004	9	x	12/576
31005	18	-	10/300
31006	18	x	12/240

### 2 HOOK UTILITY BLADES

• СЕГМЕНТНЫЕ КРЮЧКОВЫЕ ЛЕЗВИЯ  
• USWECHSELBARE ABBRECH-HAKENKLINGE



x10 Sk5

- 10 blades in a box

Code	Blade (mm)		
31307	18	x	24/288

### 3 UTILITY BLADES

• ТРАПЕЦИДАЛЬНЫЕ ЛЕЗВИЯ • AUSWECHSELBARE TRAPEZ-KLINGE



x10 0,6mm 61mm Sk5

- 10 blades in a box with a dispenser

Code	Blade (mm)		
31302	61	-	50/400
31303	61	x	12/288

### 4 HOOK UTILITY BLADES

• ТРАПЕЦИДАЛЬНЫЕ КРЮЧКОВЫЕ ЛЕЗВИЯ • AUSWECHSELBARE ABBRECH-HAKENKLINGE



x5 0,6mm 48mm Sk5

- 5 blades in a box with a dispenser

Code	Blade (mm)		
31304	48	-	50/400
31305	48	x	16/288

### 5 POCKET MULTI-TOOL

• МУЛЬТИТУЛ • MUMULTIFUNKTIONSZANGE

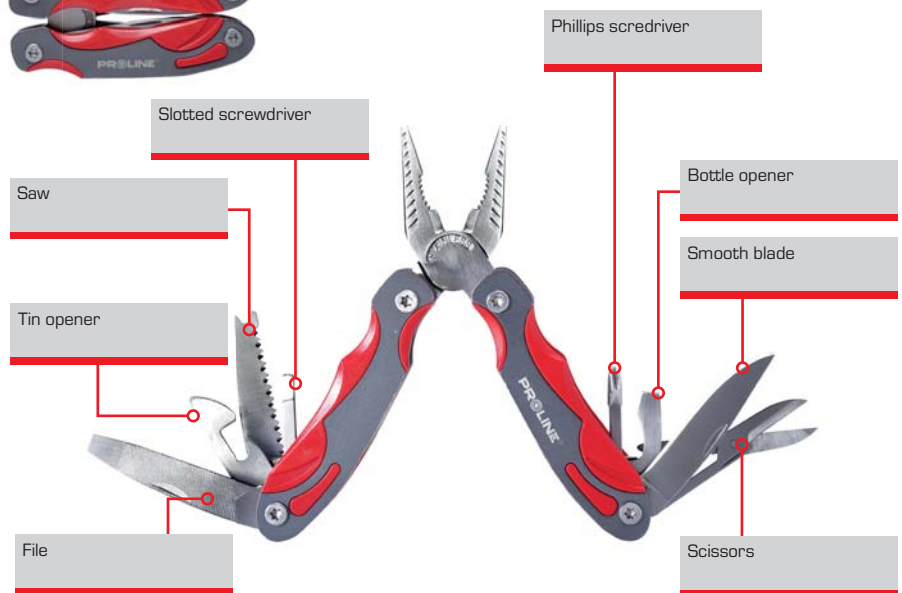

150 mm STAINLESS AL HRC 45±3

- Stainless steel • Aluminium body • The set includes: pliers, smooth blade, saw, file, Phillips screwdriver, slotted screwdriver, bottle opener, tin opener, scissors • Nylon case with velcro

Code	Length (mm)		
30050	150	x	12/48

### 6 POCKET MULTI-TOOL AND FOLDING KNIFE SET

• НАБОР: МУЛЬТИТУЛ И НОЖ УНИВЕРСАЛЬНЫЙ СКЛАДНОЙ • SET: MULTIFUNKTIONSZANGE UND UNIVERSALKLAPPMESSER

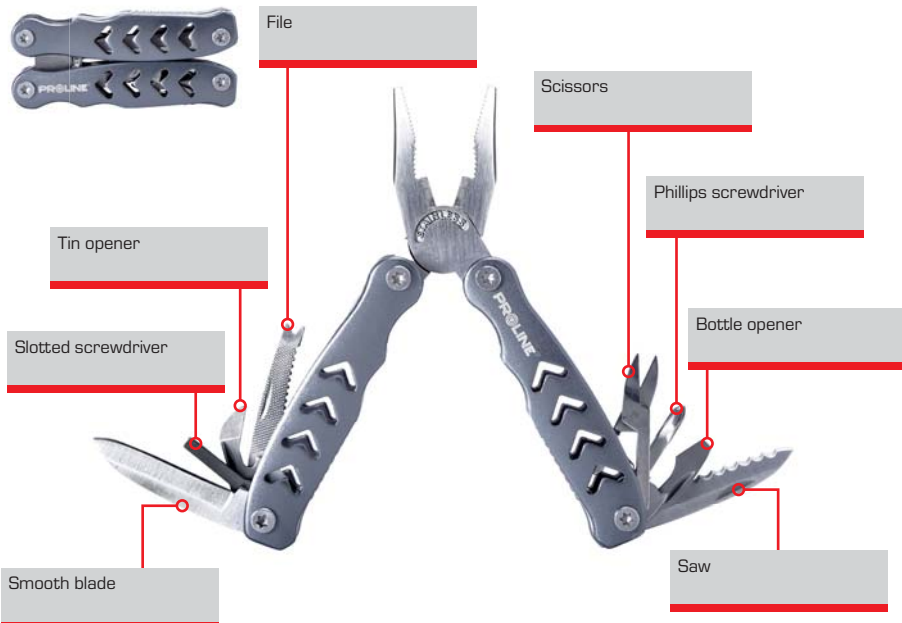

190 mm 148 mm STAINLESS AL HRC 45±3

- Stainless steel • Aluminium body • The set includes: pliers, flat blade, saw, file, Phillips screwdriver, slotted screwdriver, bottle opener, tin opener, scissors • „Liner-lock” blade lock • Belt hook • Nylon casing with velcro

Code	Blade of the knife (mm)	Length (mm)		
30060	80	148	x	9/36

**1 MEASURING TAPES**

• PУЛЕТКИ • ROLLMASSBÄNDER

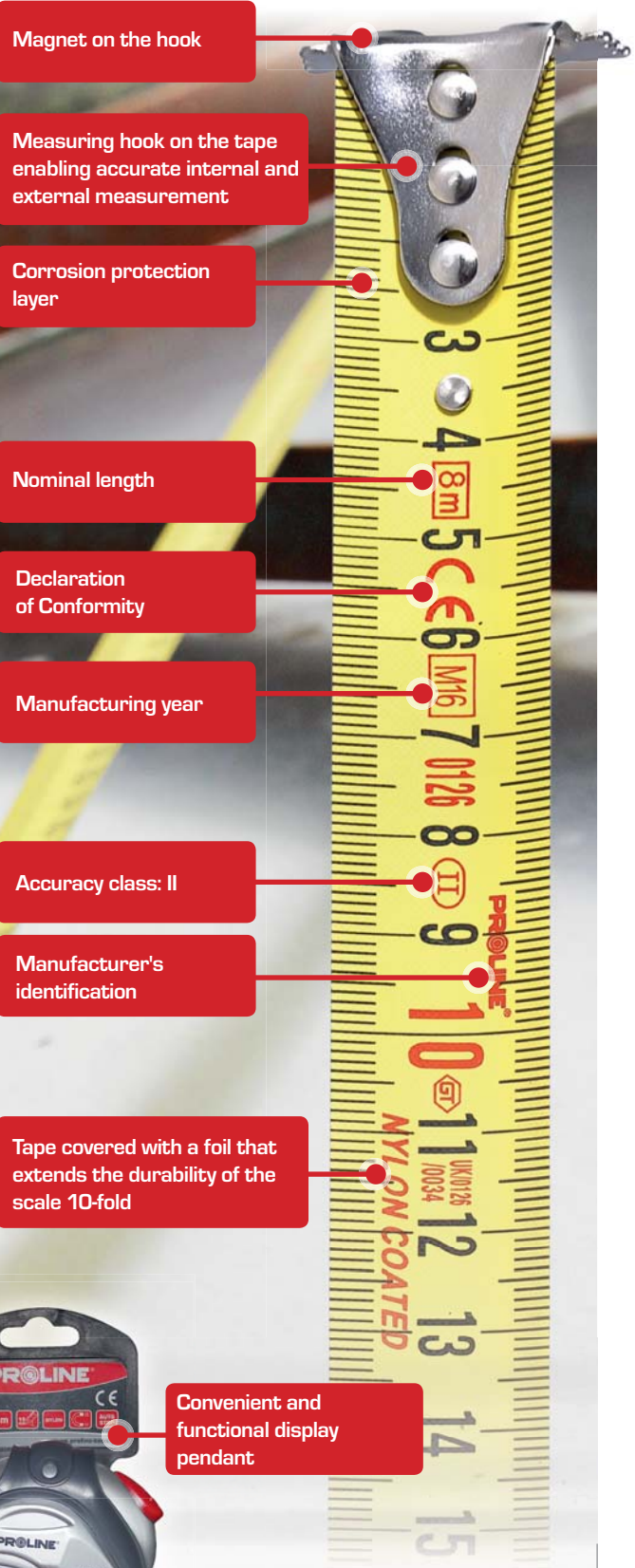
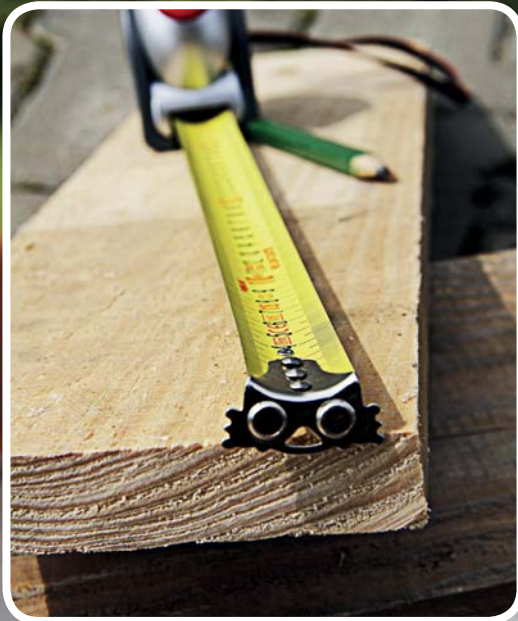

Magnet on the hook

Measuring hook on the tape enabling accurate internal and external measurement

Corrosion protection layer

Nominal length

Declaration of Conformity

Manufacturing year

Accuracy class: II

Manufacturer's identification

Tape covered with a foil that extends the durability of the scale 10-fold



Convenient and functional display pendant

Durable case with tape lock and belt clip



- 2nd precision class • CE MID Certificate • Tape cover - nylon (protection against abrasion) • Magnet on a catch • Automatic tape lock when advanced (lock released by button pressing) • Clip for a belt • Casing with rubber-coated overlay

Code	Length (m)	Tape (mm)		
20283	3	16	x	12/120
20285	5	19	x	12/72
20288	8	25	x	6/36

PROLINE  
LAHTI PRO  
MEGA  
JUCO  
OTHER BRANDS  
ERDI  
KLINGSPOR  
EXPRESS  
ACTION CAN  
TRYTON  
VULCAN

**1 TWO-SIDED MEASURING TAPES, WHITE TAPE**

- РУЛЕТКИ ДВУХСТОРОННИЕ, ЛЕНТА БЕЛОГО ЦВЕТА
- ZWEISEITIGE MASSBÄNDER, WEISSES BAND



- 2nd precision class • CE MID Certificate
- Tape cover - nylon (protection against abrasion) • Magnet on a catch • Automatic tape lock when advanced (lock released by button pressing) • Clip for a belt • Casing with rubber-coated overlay • double-sided print to enable vertical and horizontal reading • White tape

Code	Length (m)	Tape (mm)		
20363	3	16	x	12/120
20365	5	19	x	12/72
20368	8	25	x	6/36

**4 MEASURING TAPES**

- РУЛЕТКИ С МАГНИТНЫМ ЗАХВАТОМ • ROLLMASSBÄNDER



- 2nd precision class • Magnetic catch • 3 additional non-step brakes, including one from below • Casing from non-slip material • Clip for a belt • Tape covered with nylon protecting against abrasion

Code	Length (m)	Tape (mm)		
20132	2	16	-	12/120
20133	3	16	-	12/120
20135	5	19	-	12/96
20137	7.5	25	-	6/60
20132K	2	16	x	12/120
20133K	3	16	x	12/120
20135K	5	19	x	12/96
20137K	7.5	25	x	6/48

**7 FIBREGLASS MEASURING TAPES**

- ДЛИННЫЕ РУЛЕТКИ ИЗ СТЕКЛОВОЛОКНА • MASSBÄNDER LANG AUS GLASFASER



- Fibre glass tape
- Delivered in cardboard box

Code	Length (m)		
20323	30	x	24
20325	50	x	24
20329	100	x	12

**2 MEASURING TAPES**

- РУЛЕТКИ • ROLLMASSBÄNDER



- 2nd precision class • CE MID Certificate
- Tape cover - nylon (protection against abrasion) • Automatic tape lock when advanced (lock released by button pressing) • Clip for a belt • Casing with rubber-coated overlay

Code	Length (m)	Tape (mm)		
20293	3	16	x	12/120
20295	5	19	x	12/96
20298	8	25	x	6/48

**5 MEASURING TAPES**

- РУЛЕТКИ • ROLLMASSBÄNDER



- 2nd precision class • Tape self-lock when advancing • Lock released by pressing a button • Ergonomic, two-component casing from non-slip material

Code	Length (m)	Tape (mm)		
20142	2	16	-	12/120
20143	3	16	-	12/120
20145	5	19	-	12/96
20147	7.5	25	-	6/48
20142K	2	16	x	12/120
20143K	3	16	x	12/120
20145K	5	19	x	12/96
20147K	7.5	25	x	6/48

**3 MEASURING TAPES**

- РУЛЕТКИ • ROLLMASSBÄNDER



- 2nd precision class • CE MID Certificate
- Tape cover - nylon (protection against abrasion) • Automatic tape lock when advanced (lock released by button pressing) • Clip for a belt • Ergonomic shape

Code	Length (m)	Tape (mm)		
20123	3	16	x	12/120
20125	5	19	x	12/96
20128	8	25	x	6/48

**6 STEEL MEASURING TAPES**

- ДЛИННЫЕ СТАЛЬНЫЕ РУЛЕТКИ • MASSBÄNDER LANG AUS STAHL



- 2nd precision class • Steel tape covered with nylon to increase its lifecycle • Fast winding mechanism • Two-component casing from non-slip material

Code	Length (m)		
20351	10	x	50
20352	20	x	30
20353	30	x	30

**8 FIBREGLASS MEASURING TAPES**

- ДЛИННЫЕ РУЛЕТКИ ИЗ СТЕКЛОВОЛОКНА
- MASSBÄNDER LANG AUS GLASFASER



- Tape made from reinforced fibre glass
- Tensile strength up to 200 kg

Code	Length (m)		
20301	10	x	50
20302	20	x	50
20303	30	x	40
20305	50	x	24

PROLINE

LANITI PRO

MEGA

JUCO

OTHER BRANDS

ERDI

KLINGSPOR

EXPRESS

ACTION CAN

TRYTON

VULCAN

**1 HARDWOOD FOLDING RULES**

**- HIDDEN RIVETS**

- ДЕРЕВЯННЫЕ СКЛАДНЫЕ ЛИНЕЙКИ - СКРЫТЫЕ ЗАКЛЁПКИ
- HOLZ-ZOLLSTOCK - VERSTECKTE NIETEN



- 3rd precision class (EU certificate) • Beech wood 3 mm thickness • Concealed rivets
- Rivet-free union ensures easy readout
- Lasting, resilient unions made from steel and brass • Multi-layer varnish coating, resistant to UV, abrasion and peels • FSC certificate

Code	Length (m)	Type		
13012	1	5-piece	x	20/200
13013	2	10-piece	x	10/100

**2 HARDWOOD FOLDING RULES**

- ДЕРЕВЯННЫЕ СКЛАДНЫЕ ЛИНЕЙКИ
- HOLZ-ZOLLSTOCK - VERSTECKTE NIETEN



- 3rd precision class (EU certificate)
- High quality • Beech wood 3 mm thickness

Code	Length (m)	Type		
13010	1	5-piece	x	20/200
13011	2	10-piece	x	10/100

**3 COMBINATION SQUARE**

- УНИВЕРСАЛЬНЫЙ УГОЛЬНИК - UNIVERSALWINKEL

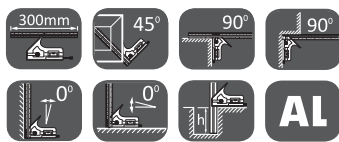

- Steel base with a level, stylus and adjustment bolt • Aluminium measure with two-side scale on both edges

Code	Size (mm)		
21230	300	x	12/72

**4 TRY SQUARES**

- АЛЮМИНИЕВЫЕ УГОЛЬНИКИ - WINKEL



- Rigid • Metric and inch scale, two-side

Code	Size (mm)		
21330	300 x 175	x	12/48
21335	350 x 190	x	12/48
21350	500 x 235	x	12/36

**5 UNIVERSAL RULER**

- УНИВЕРСАЛЬНАЯ ЛИНЕЙКА С ПЕРЕДВИЖНЫМИ ИНДИКАТОРАМИ - UNIVERSALLINEAL



- Aluminium ruler with two sliding level vials: horizontal and vertical • Offers easy fixing of objects, centering, copying distance etc.
- Additionally, openings Ø 4-12 mm and a box for screws etc.

Code	Length (mm)	
15166	600	20

**6 CALIPER**

- ШТАНГЕНЦИРКУЛЬ - MESSSCHIEBER



- Stainless steel



Code	Range (mm)	
20515	0-150	6/24

**7 DIGITAL CALIPER**

- ЭЛЕКТРОННЫЙ ШТАНГЕНЦИРКУЛЬ
- DIGITALMESSSCHIEBER



- Stainless steel



Code	Range (mm)	
20516	0-150	6/24

**8 MICROMETER**

- МИКРОМЕТР
- MIKROMETER



- Sintered carbide anvil



Code	Range (mm)	
20518	0-25	6/24

**1 FEELERS**

• ЩУПЫ • FÜHLER

21210



21220



17 GAUGES LISTKÓW

• Stainless steel

Code	Length (mm)	Width (mm)	Range (mm)		
21210	100	10	0.02, 0.03, 0.04, 0.05, 0.06, 0.07, 0.08, 0.09, 0.10, 0.15, 0.20, 0.25, 0.30, 0.40, 0.50, 0.75, 1.00	x	10/200
21220	200	10	0.02, 0.03, 0.04, 0.05, 0.06, 0.07, 0.08, 0.09, 0.10, 0.15, 0.20, 0.25, 0.30, 0.40, 0.50, 0.75, 1.00	x	10/200

**2 SPIRIT LEVELS - TWO AIR BUBBLES**

• СПИРТОВЫЕ УРОВНИ - 2 ГЛАЗКА • WASSERWAAGEN – 2 LIBELLEN



AL

• Accuracy 1 mm / 1 m • Aluminium box body  
• 2 level vials: horizontal and vertical • 5-year guarantee for the level vials

Code	Length (mm)	
15804	400	5
15806	600	5
15808	800	5
15810	1000	5
15812	1200	5
15815	1500	5
15820	2000	5

**3 SPIRIT LEVELS - 2 AIR BUBBLES**

• УРОВНИ АЛЮМИНИЕВЫЕ - 2 ГЛАЗКА • WASSERWAAGE – 2 LIBELLEN

PROLINE HD®



- Measurement accuracy 0.5 mm / 1 m
- High-quality aluminium body, powder coated
- Milled measuring edge - sizes 40, 60, 80, 100, 120, 150, 180, 200 cm
- Two high quality level vials with lifelong guarantee
- Holder to hang the level



Code	Length (mm)	
15922	400	10/60
15923	600	10/60
15924	800	10/40
15925	1000	10/40
15926	1200	10/20
15927	1500	10
15929	1800	10
15928	2000	10

**4 ALUMINIUM LEVELS - 3 AIR BUBBLES**

• УРОВНИ АЛЮМИНИЕВЫЕ - 3 ГЛАЗКА • WASSERWAAGEN – 3 LIBELLEN

PROLINE HD®



- Measurement accuracy 0.5 mm / 1 m • Three high quality level vials with lifelong guarantee
- High-quality aluminium body, powder coated
- Milled from 40 to 120 cm • Holder to hang the level



Code	Length (mm)	
15932	400	10/60
15933	600	10/60
15934	800	10/40
15935	1000	10/40
15936	1200	10/20
15937	1500	10
15938	2000	10
15939	1800	10

**1 SPIRIT LEVELS - 2 AIR BUBBLES**

• СПИРТОВЫЕ АЛЮМИНИЕВЫЕ УРОВНИ - 2 ГЛАЗКА • WASSERWAAGE – 2 LIBELLEN



**AL**

- Accuracy 0.029°=0.5 mm/m • Aluminium box body • 2 level vials - horizontal and vertical indicator • Shockresistant, glued indicators
- Two magnets • Profile made from anodized aluminium offers resistance to corrosion

Code	Length (mm)	☐
15821	400	5
15822	600	5
15823	800	5
15824	1000	5
15825	1200	5
15826	1500	5
15827	2000	5

**2 SPIRIT LEVELS - 2 AIR BUBBLES**

• СПИРТОВЫЕ УРОВНИ - 2 ГЛАЗКА • WASSERWAAGEN – 2 LIBELLEN



**AL**

- Accuracy 1 mm / 1 m • Aluminium box body • Wall thickness at least 1.5 mm • 2 level vials: horizontal and vertical • 5-year guarantee for the level vials

Code	Length (mm)	☐
15234	400	40
15236	600	40
15238	800	40
15240	1000	20
15242	1200	20
15245	1500	10

**3 SPIRIT LEVELS - 2 AIR BUBBLES**

• СПИРТОВЫЕ МАГНИТНЫЕ УРОВНИ 2 МАГНИТА 2 ГЛАЗКА • WASSERWAAGEN – 2 LIBELLEN, 2 MAGNETE



**AL**

- Accuracy 0.029°=0.5 mm/m • Aluminium box body • 2 level vials - horizontal and vertical indicator • Shockresistant, glued indicators
- Two magnets • Profile made from anodized aluminium offers resistance to corrosion

Code	Length (mm)	☐
15828	400	5
15829	600	5
15830	800	5
15831	1000	5



**4 TRAPEZOIDAL SPIRIT LEVEL - 2 AIR BUBBLES**

• СПИРТОВОЙ ТРАПЕЦЕИДАЛЬНЫЙ УРОВЕНЬ - 2 ГЛАЗКА • WASSERWAAGE IN TRAPEZFORM – 2 LIBELLEN



**AL**

- Aluminium body • 2 level vials: horizontal and vertical
- Measuring plane with additional machining

Code	Length (mm)	☐
15194	400	40

**1 MINI SPIRIT LEVEL**

• УРОВЕНЬ АЛЮМИНИЕВЫЙ МИНИ • MINIWASSERWAAGE

PROLINE HD®



- Accuracy of measurement 0.5 mm/1 m • Quality powder coated aluminium body • Compact, pocket size (10 cm) • One high-quality level resistant to shock and UV • Sold in a 10 pcs display box with a hanger (15940 is one piece)

Code	Length (mm)	
15940	100	10/100

**2 SPIRIT LEVELS - 3 AIR BUBBLES**

• СПИРТОВЫЕ УРОВНИ - 3 ГЛАЗКА  
• WASSERWAAGEN - 3 LIBELLEN



- Accuracy 1 mm / 1 m • Aluminium box body • 3 level vials: horizontal, vertical and angular; with angle setting every 1° to 90° • 5-year guarantee for the level vials • Scale on the casing

Code	Length (mm)	
15054	400	30
15056	600	30
15058	800	30
15060	1000	20
15062	1200	20
15065	1500	20
15070	2000	20

**3 SPIRIT LEVELS - 3 AIR BUBBLES**

• СПИРТОВЫЕ УРОВНИ - 3 ГЛАЗКА • WASSERWAAGEN - 3 LIBELLEN



- Accuracy 0.5 mm / 1 m (up to 1 m in length) and 1 mm / 1 m (other lengths) • Aluminium box body, wall thickness at least 1.5 mm • 3 level vials: horizontal, vertical and angular 45° • 5-year guarantee for the level vials • Measuring plane with additional machining

Code	Length (mm)	
15076	600	25
15078	800	25
15080	1000	20
15082	1200	20
15085	1500	10
15090	2000	10

**4 STRAIGHT EDGES**

• СТРОИТЕЛЬНЫЕ ПРАВИЛА • MAURER-WASSERWAAGE RECHTECKIG



- Accuracy 1 mm / 1 m • Aluminium • Smooth

Code	Length (m)	
15520	2.0	5
15525	2.5	5
15530	3.0	5
15540	4.0	5

**5 STRAIGHT EDGES - 1 OR 2 AIR BUBBLES**

• СТРОИТЕЛЬНЫЕ ПРАВИЛА - 1 ИЛИ 2 ГЛАЗКА  
• MAURER-WASSERWAAGE RECHTECKIG - 1 ODER 2 LIBELLEN



- Accuracy 1 mm / 1 m • Aluminium • Shock-resistant level vial with 5-year guarantee • Straightedges with horizontal or horizontal&vertical indicator

Code	Length (m)	Quantity of levels	
15615	1.5	1	5
15620	2.0	1	5
15625	2.5	1	5
15630	3.0	1	5
15640	4.0	1	5
15720	2.0	2	5
15725	2.5	2	5
15730	3.0	2	5

**6 STRAIGHT EDGES - 2 AIR BUBBLES**

• СТРОИТЕЛЬНЫЕ ПРАВИЛА - 2 ГЛАЗКА  
• MAURER-WASSERWAAGE RECHTECKIG - 2 LIBELLEN



- Accuracy 1 mm / 1 m • Aluminium • Rectangular with two level vials

Code	Length (m)	Quantity of levels	
15721	2.0	2	5
15726	2.5	2	5
15731	3.0	2	5

**7 FEATHER EDGES**

• СТРОИТЕЛЬНЫЕ ТРАПЕЦИЕВИДНЫЕ ПРАВИЛА  
• MAURER-WASSERWAAGE TRAPEZ



- Accuracy 1 mm / 1 m • Aluminium
- For gypsum plaster

Code	Length (m)	
15410	1.0	5
15412	1.2	5
15415	1.5	5
15418	1.8	5
15420	2.0	5
15424	2.4	5
15430	3.0	5

PROLINE

LAHTI PRO

MEGA

JUCO

OTHER BRANDS

ERDI

KLINGSPOR

EXPRESS

ACTION CAN

TRYTON

VULCAN

**1 LASER LEVEL**

- ЛАЗЕРНЫЙ УРОВЕНЬ
- LASER-WASSERWAAGE



- Accuracy 0.5 mm / 1m • Laser power ≤ 1mW • Laser wavelength 635nm
- Work range 5 ~ 10m • Range of automatic levelling 4° - self-levelling
- Power supply 2xAA 3V • Easy measurement and ability to switch on a horizontal and/or vertical laser beam • Wide applicability inside and outside
- Separate vertical and horizontal line control • Revolving base can be installed on a stand • Magnetic, automatic stabilisation • Easy and reliable device locking system • The set includes a stand improving measuring abilities, glasses improving laser beam visibility • Packed in a case

Code	Measuring range (m)	Stand adjustment (mm)	
15170	10	55-125	4



**2 GRADIENT LEVELS**

- СПИРТОВЫЕ УРОВНИ ДЛЯ НАКЛОННЫХ ПОВЕРХНОСТЕЙ
- NEIGUNGSWINKEL-WASSERWAAGEN



**AL**

- For accurate gradient making • Aluminium box body • Groove in the pipe base • Measuring plane with additional machining • Each level has 5 vials: horizontal, vertical, 45° and two gradient ones, 1.5° and 3.5°

Code	Length (mm)	
15396	600	50
15398	800	50

**3 POST LEVEL**

- СПИРТОВОЙ УРОВЕНЬ ДЛЯ СТОЛБОВ И КОСЯКОВ • PFOSTEN-WASSERWAAGE



- Any angle of application, with toothed scale every 15° • Magnetic • 3 vials: • 2 horizontal and vertical • Ability to measure the horizontal aspect of flat surfaces • Foldable, for easy storage

Code	Length (mm)		
15300	135	x	50



**1 CROSS LASER**

• ЛАЗЕРНЫЙ НИВЕЛИР • KREUZLASER



- Accuracy 0.5 mm / 1m • Laser power ≤ 1mW • Laser wavelength 635nm • Work range 15m indoor (up to 20m with the detector)
- Range of automatic levelling 4 ° (± 1°)- self-levelling • Power supply 2xAA 1,5V • Easy measurement and ability to switch on a horizontal and/or vertical laser beam • Wide applicability inside and outside
- Can be installed on a stand ( 1/4") • Easy and reliable device locking system enabling oblique lines determination • Include: cross laser, clamping buckle with moving head, case

Code	Range (m)	
15175	15	20

**2 MULTIMETER**

• МУЛЬТИМЕТР • MULTIMETER



- Backlit LCD screen • Hold system for maintaining the lit measurement

Code	
15186	40

**3 CLAMP MULTIMETER**

• КЛЕЩИ-МУЛЬТИМЕТР • KLEMMMULTIMETER



- Non-contact inductive measurement of alternating current (A)
- Backlit LCD screen • Hold system for maintaining the lit measurement
- Automatic (10 min.) turn-off function.

Code	
15187	60



**1 LASER DISTANCE METER**

• ЛАЗЕРНЫЙ ДАЛЬНОМЕР • LASER-ENTFERNUNGSMESSE

**MIN. 0,05m** Minimum distance measured

**UP TO 5000 TIMES** Number of measurements on one battery set

**Pythagorean function** (direct and indirect)

**Screen backlight**

**Device with a laser measuring beam**

**Storage of the last 20 measurements**

**x 2 AAA** Power source 2 AAA batteries

**d.c. 3 V** Supply voltage 3V



Keyboard

**1** Switching on the device / Distance measurement / Continuous measurement

**2** Function button

**3** Add button

**4** Selection button for the measurement reference plane

**5** Memory button

**6** Subtraction button

**7** Button for resetting /deactivating the device



Foot



- Measurement time 0.5 sec. • Class II laser • Type of laser 635 nm, <1 mW • Diameter of the laser spot (at lengths) 6 mm at 10 m, 30 mm at 40 m • Automatic switch-off after 180 s • Backlit screen • Storage for 20 measurements • 3 starting points: the rangefinder's front, back or foot in the case of measurements in a corner • Three types of measurements: single measurement, continuous measurement, Pythagorean theorem - direct and indirect, surface area and volume calculation • Measurement of a plane inclination angle (only in the 15174 model) • Possibility to add and subtract measurements • Battery lifetime (AAA, 2 x 1.5 V) for 5000 measurements • Dimensions and weight: 120 mm x 48 mm x 24 mm, 109 g
- Temperature range: storage from -20 °C to + 65 °C, work from 0 °C up to + 40 °C • Packed in a box with an instruction manual

Code	Measurement range (m)	Measurement accuracy	Measurement of the surface inclination angle	
15173	0.05-20	+/-3mm (max +/-5mm)	-	20
15174	0.05-40	+/-2mm (max +/-3mm)	do 90°	20

PROLINE

LAHTI PRO

MEGA

JUCO

OTHER BRANDS

ERDI

KLINGSPOR

EXPRESS

ACTION CAN

TRYTON

VULCAN

**1 MACHINIST HAMMERS**

• Слесарные молотки • Schlosserhämmer



**STAL IC45** **DIN 1041** **HRC 55±2**

- Forged and quenched head
- Handle made from ashen wood with plastic cover preventing hammer base damage (the cover not installed in 2000g hammer)

Code	Weight (g)	☐
12581	100	10
12582	200	10
12583	300	10
12585	500	10
12587	700	10
12588	800	10
12590	1000	10
12591	1500	6
12592	2000	6

**2 MACHINIST HAMMERS**

• Слесарные молотки • Schlosserhämmer



**DIN 1041** **HRC 54±2**

- Forged and quenched head
- Wooden handle, varnished with plastic cover
- Reinforced head seating by means of an expandable bushing and resin

Code	Weight (g)	☐
12601	100	10
12602	200	10
12603	300	10
12604	400	10
12605	500	10
12608	800	10
12610	1000	10
12615	1500	6
12620	2000	6

**3 MACHINIST HAMMERS - FIBREGLASS SHAFT**

• Слесарные молотки • Ручьятка из стекловолокна • Schlosserhämmer - Glasfaserstiel



**75% GRP** **DIN 1041** **HRC 54±2**

- Forged and quenched head
- Two-composite, non-slip TPR handle

Code	Weight (g)	☐
12511	100	6/96
12512	200	6/60
12513	300	6/48
12514	400	6/36
12515	500	6/36
12518	800	6/24
12520	1000	6/18
12521	1500	6/12
12522	2000	4/8

**4 MACHINIST HAMMERS - FIBREGLASS SHAFT**

• Слесарные молотки • Ручьятка из стекловолокна • Schlosserhämmer - Glasfaserstiel



**GRP** **DIN 1041** **HRC 54±2**

- Forged and quenched head
- Non-slip handle

Code	Weight (g)	☐
12502	200	12/60
12503	300	6/48
12504	400	6/36
12505	500	6/36
12508	800	6/24
12510	1000	6/12

**5 STEEL TUBE MACHINIST HAMMERS**

• Слесарные молотки, ручьятка из стальной трубки • Schlosserhämmer - Rohrstiel



**DIN 1041** **HRC 55±2**

- Forged, quenched and polished head
- Two-composite, non-slip TPR handle
- Additional protection of the head and handle with rivets

Code	Weight (g)	☐
12547	300	6/24
12546	500	6/24

**6 MONOBLOCK CLAW HAMMER**

• Молоток столярный, моноблок • Schreinerhammer - Monoblock



**ASME** **C1**

- Handle and head made from a single steel component ensure hammer durability
- Forged, quenched and polished head
- Two-composite, non-slip TPR handle
- Additional handle protection with a rivet

Code	Weight (g)	☐
12220	450	4/24

PROLINE

LAHTI PRO

MEGA

JUCO

OTHER BRANDS

ERDI

KLINGSPOR

EXPRESS

ACTION CAN

TRYTON

VULCAN

**1 CLAW HAMMER - FIBREGLASS SHAFT**

- МОЛОТОК СТОЛЯРНЫЙ - РУКОЯТКА ИЗ СТЕКЛОВОЛОКНА
- SCHREINERHAMMER - GLASFASERSTIEL



**GRP** **HRC**  
54±2

- Forged, quenched and polished head
- Two-composite, non-slip TPR handle

Code	Weight (g)	
12523	450	6/24

**4 MASONRY HAMMER - B TYPE - FIBREGLASS SHAFT**

- МОЛОТОК КАМЕНЩИКА - БЕРЛИНСКИЙ - РУКОЯТКА ИЗ СТЕКЛОВОЛОКНА • MAURERHAMMER BERLINER FORM - GLASFASERSTIEL



**GRP** **DIN**  
5108 **HRC**  
54±2

- Forged, quenched and polished head • Two-composite, non-slip TPR handle

Code	Weight (g)	
12527	600	6/24

**2 ROOFING HAMMER - FIBREGLASS SHAFT**

- МОЛОТОК КРОВЕЛЬЩИКА - РУКОЯТКА ИЗ СТЕКЛОВОЛОКНА
- ZIMMERMANNHAMMER - GLASFASERSTIEL



**GRP** **DIN**  
7239 **HRC**  
54±2

- Forged, quenched and polished head
- Two-composite, non-slip TPR handle

Code	Weight (g)	
12524	600	6/24

**5 STONE HAMMERS**

- МОЛОТКИ КАМЕНЩИКА • STEINMETZHAMMER



**DIN**  
6475 **75%**  
**GRP**

- Forged and quenched head
- Two-composite, non-slip TPR handle

Code	Weight (g)	
12561	1000	6/18
12565	1500	6/12
12572	2000	4/8

**3 MASONRY HAMMER - R TYPE - FIBREGLASS SHAFT**

- МОЛОТОК КАМЕНЩИКА - РЕЙНСКИЙ - РУКОЯТКА ИЗ СТЕКЛОВОЛОКНА
- MAURERHAMMER RHEINISCHE FORM - GLASFASERSTIEL



**GRP** **DIN**  
5108 **HRC**  
54±2

- Forged, quenched and polished head • Two-composite, non-slip TPR handle

Code	Weight (g)	
12526	600	6/24

**6 RUBBER MALLETS**

- РЕЗИНОВЫЕ МОЛОТКИ • GUMMINHAMMER



- Head made from two-colour rubber
- Additional reinforcement of head base with a nail
- Handle varnished, made from high-quality hard wood

Code	Weight (g)	Head diameter (mm)	
12021	230	44	12/48
12022	340	49	12/48
12023	370	50	6/36
12024	580	58	6/36
12025	780	63	6/24
12026	980	72	6/12

**1 DEAD-BLOW HAMMERS**

• МОЛОТОК БЕЗ ОТСКОКА • KUNSTSTOFFHAMMER



- Head filled with metal shot reduces rebound after the strike
- Monolithic rubber plastic structure does not damage material during work
- Non-slip handle

Code	Weight (g)	Head diameter (mm)	
12611	840	48	6/24
12612	940	53	6/24
12613	1360	60	6/12

**2 DUAL-HEAD HAMMERS**

• МОЛОТКИ ЖЕСТЯНЩИКА • DOPPELKOPFHAMMER



**PU** **NYLON**

- Hammers with 2 interchangeable heads: soft (gray PU) and hard (red NYLON) available separately (12631-12635)

Code	Weight (g)	Head diameter (mm)	
12621	135	22	6/48
12622	230	28	6/48
12623	350	35	6/36
12624	645	45	6/24
12625	1520	60	6/12

**3 HEADS FOR DUAL-HEAD HAMMERS**

• НАКОНЕЧНИКИ ДЛЯ МОЛОТКОВ ЖЕСТЯНЩИКА • KÖPFE FÜR DOPPELKOPFHAMMER



**PU** **NYLON**

- Soft PU (gray) and hard NYLON (red) • Suitable for Proline 12621-12625 dual-head hammers and other models on the market with the same mounting

Code	Head diameter (mm)	
12631	22	100
12632	28	100
12633	35	100
12634	45	100
12635	60	100

**4 AUTO-BODY REPAIR HAMMER SET**

• НАБОР МОЛОТКОВ ЖЕСТЯНЩИКА • KAROSSERIE-REPARATURHAMMER-SET



**x7** **HRC 54±2** **GENUINE HICKORY**

- The set includes: 3 hammers with different heads, 4 steel anvils for shaping steel sheet and a carrying case

Code	Weight (g)	
12670	5000	4

PROLINE

LAHTI PRO

MEGA

JUCCO

OTHER BRANDS

ERDI

KLINGSPOR

EXPRESS

ACTION CAN

TRYTON

VILCANA

PROLINE

LANITI PRO

MEGA

JUCO

OTHER BRANDS

ERDI

KLINGSPOR

EXPRESS

ACTION CAN

TRYTON

VULCAN

**1 SMOOTH STAINLESS PLASTERING TROWELS**

- ШТУКАТУРНЫЕ НЕРЖАВЕЮЩИЕ ГЛАДИЛКИ
- EDELSTAHL-GLÄTTKELLE



61530



61536-61539

STAINLESS

- Wooden handle • Aluminium foot

Code	Dimension (mm)	☐
61530	270 x 130	40
61536	380 x 130	25
61537	480 x 130	25
61538	580 x 130	30
61539	680 x 130	30

**2 SMOOTH STAINLESS PLASTERING TROWEL**

- ШТУКАТУРНАЯ НЕРЖАВЕЮЩАЯ ГЛАДИЛКА
- EDELSTAHL-GLÄTTKELLE



STAINLESS

- Two-component plastic handle

Code	Dimension (mm)	☐
61520	270 x 130	30

**3 SMOOTH STAINLESS PLASTERING TROWEL**

- ШТУКАТУРНАЯ НЕРЖАВЕЮЩАЯ ГЛАДИЛКА
- EDELSTAHL-GLÄTTKELLE



STAINLESS

- Two-component plastic handle • Aluminium foot

Code	Dimension (mm)	☐
61510	270 x 130	40

**4 SMOOTH STAINLESS PLASTERING TROWEL**

- ШТУКАТУРНАЯ НЕРЖАВЕЮЩАЯ ГЛАДИЛКА
- EDELSTAHL-GLÄTTKELLE



STAINLESS

- Two-component plastic handle
- Aluminium foot

Code	Dimension (mm)	☐
61640	280 x 130	30

**5 STAINLESS ADHESIVE SPREADING TROWELS**

- ГЛАДИЛКИ ВЫРАВНИВАЮЩИЕ С ЗУБЦАМИ
- EDELSTAHL-GLÄTTKELLE MIT ZÄHNE

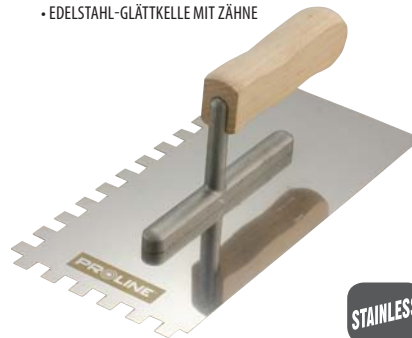

STAINLESS

- Wooden handle • Aluminium foot

Code	Dimension (mm)	Tooth (mm)	☐
61531	270 x 130	4 x 4	40
61532	270 x 130	6 x 6	40
61533	270 x 130	8 x 8	40
61534	270 x 130	10 x 10	40
61535	270 x 130	12 x 12	40

**6 STAINLESS ADHESIVE SPREADING TROWELS**

- ГЛАДИЛКИ ВЫРАВНИВАЮЩИЕ С ЗУБЦАМИ
- EDELSTAHL-GLÄTTKELLE MIT ZÄHNE



STAINLESS

- Two-component plastic handle

Code	Dimension (mm)	Tooth (mm)	☐
61521	270 x 130	4 x 4	30
61522	270 x 130	6 x 6	30
61523	270 x 130	8 x 8	30
61524	270 x 130	10 x 10	30
61525	270 x 130	12 x 12	30

**7 STAINLESS ADHESIVE SPREADING TROWELS**

- ГЛАДИЛКИ ВЫРАВНИВАЮЩИЕ С ЗУБЦАМИ
- EDELSTAHL-GLÄTTKELLE MIT ZÄHNE

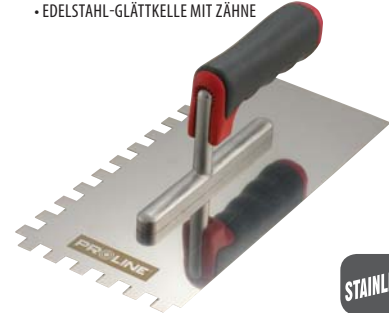

STAINLESS

- Two-component plastic handle • Aluminium foot

Code	Dimension (mm)	Tooth (mm)	☐
61511	270 x 130	4 x 4	40
61512	270 x 130	6 x 6	40
61513	270 x 130	8 x 8	40
61514	270 x 130	10 x 10	40
61515	270 x 130	12 x 12	40

**8 STAINLESS ADHESIVE SPREADING TROWELS**

- ГЛАДИЛКИ ВЫРАВНИВАЮЩИЕ С ЗУБЦАМИ
- EDELSTAHL-GLÄTTKELLE MIT ZÄHNE



STAINLESS

- Two-component plastic handle
- Aluminium foot

Code	Dimension (mm)	Tooth (mm)	☐
61644	280 x 130	4 x 4	30
61646	280 x 130	6 x 6	30
61648	280 x 130	8 x 8	30
61649	280 x 130	10 x 10	30

**9 CARBON BRICK TROWELS**

- КЕЛЬМЫ КАМЕНЩИКА ТРЕУГОЛЬНЫЕ
- STAHL-MAURERKELLEN DREIECKIG



CARBON

- Two-component plastic handle

Code	Size (mm)	☐
61581	160	30
61582	180	20
61583	200	20

**1 STAINLESS BRICK TROWELS**

- НЕРЖАВЕЮЩИЕ КЕЛЬМЫ КАМЕНЩИКА ТРЕУГОЛЬНЫЕ
- EDELSTAHL-MAURERKELLEN DREIECKIG



STAINLESS

- Two-component plastic handle

Code	Size (mm)	☐
61571	160	30
61572	180	20
61573	200	20

**2 STAINLESS BRICK TROWEL**

- НЕРЖАВЕЮЩАЯ КЕЛЬМА ШТУКАТУРНАЯ
- EDELSTAHL-STUCKATEURKELLE



STAINLESS

- Two-component plastic handle

Code	Blade length (mm)	☐
61579	132	12

**3 CARBON GAUGING TROWEL**

- КЕЛЬМА ШТУКАТУРНАЯ
- STAHL-STUCKATEURKELLE



CARBON

- Two-component plastic handle

Code	Blade length (mm)	☐
61589	140	12

**4 STAINLESS BUCKET TROWELS**

- НЕРЖАВЕЮЩИЕ КЕЛЬМЫ КАМЕНЩИКА ТРАПЕЦЕИДАЛЬНЫЕ
- EDELSTAHL-TRAPEZKELLEN



STAINLESS

- Two-component plastic handle

Code	Dimension (mm)	☐
61575	140 x 90 x 60	12
61576	160 x 90 x 60	30
61577	180 x 120 x 90	30

**5 STAINLESS STRIPPING KNIVES**

- НЕРЖАВЕЮЩИЕ ШПАТЕЛЯ • EDELSTAHL-SPACHTEL



STAINLESS

- Wide blade seating in the handle
- Two-component plastic handle

Code	Width (mm)	☐
61562	40	20
61563	60	20
61564	80	20
61565	100	20
61566	120	20
61567	150	20

**6 WALL SCRAPERS**

- НЕРЖАВЕЮЩИЕ ШПАТЕЛЯ
- EDELSTAHL-SPACHTEL



STAINLESS

- Polished • High blade resilience
- Two-component non-slip TPR handle

Code	Width (mm)	☐
31180	30	6/48
31181	40	6/48
31182	50	6/48
31183	60	6/48
31184	80	6/48
31185	100	6/48
31186	125	6/48
31187	150	6/48

**7 WALL SCRAPERS**

- СТАЛЬНЫЕ ШПАТЕЛЯ
- STAHL-SPACHTEL



- Polished • Two-component non-slip handle

Code	Width (mm)	☐
31170	30	12/240
31171	40	12/240
31172	50	12/240
31173	60	12/240
31174	80	12/240
31175	100	12/240
31176	125	12/240
31177	150	12/240

**8 WALL SCRAPERS**

- СТАЛЬНЫЕ ШПАТЕЛЯ
- STAHL-SPACHTEL



- Polished • Two-component non-slip handle

Code	Width (mm)	☐
31031	30	12/240
31041	40	12/240
31051	50	12/240
31061	60	12/240
31081	80	12/240
31101	100	12/240
31121	125	12/240

**9 STAINLESS STRIPPING KNIVES**

- НЕРЖАВЕЮЩИЕ ШПАТЕЛЯ
- EDELSTAHL-SPACHTEL FÜR FEINPUTZ



STAINLESS

- Plastic handle

Code	Width (mm)	Blade height (mm)	☐
61552	335	75	20
61553	340	95	20

**10 PLASTER SMOOTHERS**

- АБРАЗИВНЫЕ ЗАТИРОЧНЫЕ СЕТКИ • SCHLEIFNETZE



- Double adhesive layer, offering high efficiency and resistance • Perfect for gypsum, wooden, stone surfaces

Code	Dimension (mm)	Granulation	☐
61804	275 x 105	P40	50/1200
61806	275 x 105	P60	50/1500
61808	275 x 105	P80	50/1750
61810	275 x 105	P100	50/2250
61812	275 x 105	P120	50/2250
61815	275 x 105	P150	50/2500
61818	275 x 105	P180	50/2750
61822	275 x 105	P220	50/2750
61824	275 x 105	P240	50/3000
61832	275 x 105	P320	50/3000
61840	275 x 105	P400	50/3000

**1 PAINT STIRRERS**

• НАСАДКИ ДЛЯ СТРОИТЕЛЬНЫХ МИКСЕРОВ • RÜHRSTÄBE

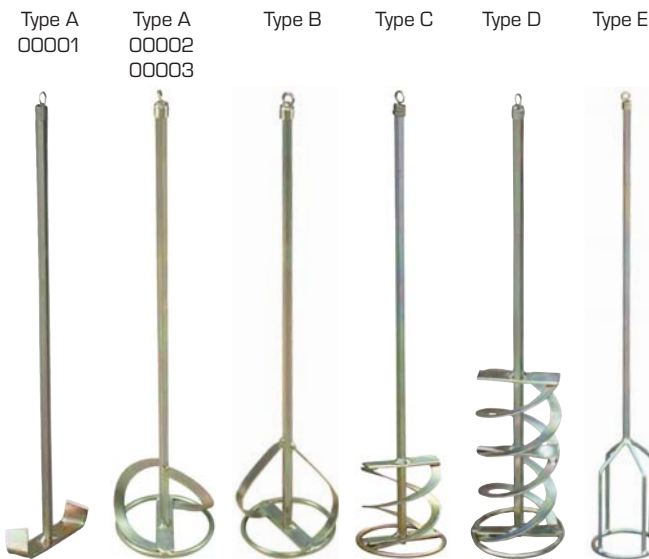

- PROFESSIONAL QUALITY
- GALVANISED STEEL WITH VARIOUS ENDINGS: HEXAGONAL (TYPE A, B, C, D, E) OR SDS PLUS (TYPE C) OR WITH M14 THREAD (TYPE C, E) SUSPENSION

**TYPE A – FOR PAINTS** (emulsion, acrylic, dispersion paints, varnishes, wood stains and all-purpose paints), recommended mixing speed 300-500 rpm

Code	Diameter x Length (mm)	Weight of mixed material (kg)	Rod ending	
00001	60 x 300	0.8 - 2	hexagonal - 6mm	10
00002	80 x 400	5 - 15	hexagonal - 8mm	10
00003	100 x 500	5 - 20	hexagonal - 8mm	10

**TYPE B – FOR SEMI-LIQUID MATERIALS** (jointless floors, self-levelling compound, bituminous compounds: binders, abizol, dysperbit), recommended mixing speed 300-600 rpm

Code	Diameter x Length (mm)	Weight of mixed material (kg)	Rod ending	
00004	80 x 400	5 - 15	hexagonal - 8mm	10
00005	100 x 500	5 - 25	hexagonal - 8mm	10

**TYPE C – FOR THICK MATERIALS** (thinset mortar; glues for thermal insulation, structural plaster; plaster; masonry mortar and concrete), recommended mixing speed 200-500 rpm

Code	Diameter x Length (mm)	Weight of mixed material (kg)	Rod ending	
00006	80 x 400	10 - 20	hexagonal - 8mm	10
00007	100 x 500	10 - 20	hexagonal - 8mm	10
00008	120 x 600	16 - 35	hexagonal - 10mm	10
00013	120 x 600	16 - 35	SDS PLUS	10
00014	120 x 600	16 - 35	M14	10

**TYPE D – FOR HEAVY MORTARS** (thinset mortar; glues for thermal insulation, structural plaster; plaster; masonry mortar and concrete), recommended mixing speed 200-500 rpm. The work part is twice longer than for C type.

Code	Diameter x Length (mm)	Weight of mixed material (kg)	Rod ending	
00009	80 x 400	10 - 30	hexagonal - 8mm	10
00010	100 x 500	10 - 40	hexagonal - 8mm	10

**TYPE E – FOR GYPSUM** (gypsum, gypsum plaster, putty coat), recommended mixing speed 200-500 rpm.

Code	Diameter x Length (mm)	Weight of mixed material (kg)	Rod ending	
00011	80 x 530	10 - 15	hexagonal - 8mm	10
00012	100 x 540	12 - 30	hexagonal - 8mm	10
00015	120 x 540	15 - 35	M14	10

**2 PAINT STIRRERS**

• НАСАДКИ ДЛЯ СТРОИТЕЛЬНЫХ МИКСЕРОВ • RÜHRSTÄBE

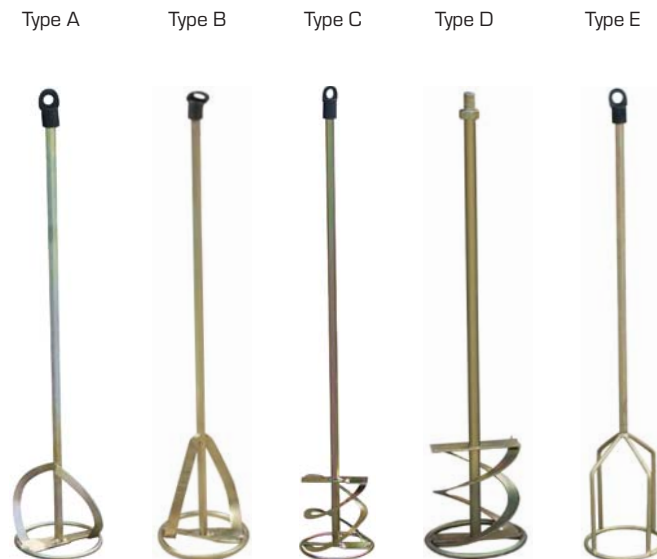

- PROFESSIONAL QUALITY
- GALVANISED STEEL WITH VARIOUS ENDINGS: HEXAGONAL (TYPE A, B, C, E) OR WITH M14 THREAD (TYPE D, E) SUSPENSION

**TYPE A – FOR PAINTS** (emulsion, acrylic, dispersion paints, varnishes, wood stains and all-purpose paints), recommended mixing speed 300-500 rpm

Code	Diameter x Length (mm)	Weight of mixed material (kg)	Rod ending	
41022	80 x 400	5 - 15	hexagonal - 8mm	50
41023	100 x 500	5 - 20	hexagonal - 10mm	50

**TYPE B – FOR SEMI-LIQUID MATERIALS** (jointless floors, self-levelling compound, bituminous compounds: binders, abizol, dysperbit), recommended mixing speed 300-600 rpm

Code	Diameter x Length (mm)	Weight of mixed material (kg)	Rod ending	
41024	80 x 400	5 - 15	hexagonal - 8mm	50
41025	100 x 500	5 - 25	hexagonal - 10mm	50

**TYPE C – FOR THICK MATERIALS** (thinset mortar; glues for thermal insulation, structural plaster; plaster; masonry mortar and concrete), recommended mixing speed 200-500 rpm

Code	Diameter x Length (mm)	Weight of mixed material (kg)	Rod ending	
41003	80 x 400	10 - 20	hexagonal - 8mm	10/60
41004	100 x 600	10 - 40	hexagonal - 10mm	10/40

**TYPE D – FOR HEAVY MORTARS** (thinset mortar; glues for thermal insulation, structural plaster; plaster; masonry mortar and concrete), recommended mixing speed 200-500 rpm. The work part is twice longer

Code	Diameter x Length (mm)	Weight of mixed material (kg)	Rod ending	
41014	120 x 540	16 - 35	M14	24

**TYPE E – FOR GYPSUM** (gypsum, gypsum plaster, putty coat), recommended mixing speed 200-500 rpm.

Code	Diameter x Length (mm)	Weight of mixed material (kg)	Rod ending	
41011	80 x 530	5 - 15	hexagonal - 8mm	50
41012	100 x 540	12 - 30	hexagonal - 10mm	24
41015	120 x 600	16 - 35	M14	24



**1 TILE CUTTING MACHINES**

• ПЛИТКОРЕЗЫ • GERÄTE ZUM SCHNEIDEN VON FLIESEN



model 75900\*

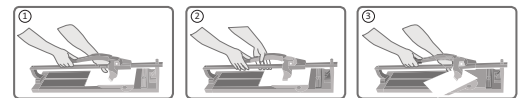

- Special, heavy-duty guide section • Adjustable guide clamp • Gauge for angular cutting • Maximum thickness of cut tile 20 mm • Aluminium base • Replacement disc available - 75725 code • Fixing set for under cutting discs available - code PKT001UW • Two side supports for stable arrangement of big tiles

Code	Cutting length (mm)	Base width (mm)	BOX	Cube
75850	500	200	x	2
75860	600	200	x	2
75870	700	200	x	2
75880	800	200	x	2
75900	1000	200 (+150+150)*	x	2

**2 TILE CUTTING MACHINES**

• ПЛИТКОРЕЗЫ • GERÄTE ZUM SCHNEIDEN VON FLIESEN

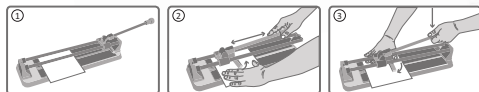

- Aluminium base • Special base reinforcement preventing deflection when cutting and breaking a tile • Maximum thickness of cut tile 14 mm • Replacement disc code 75722

Code	Cutting length (mm)	Base width (mm)	BOX	Cube
75340	400	180	x	2
75350	500	180	x	2
75360	600	180	x	2

**3 TILE CUTTING MACHINES**

• ПЛИТКОРЕЗЫ • GERÄTE ZUM SCHNEIDEN VON FLIESEN

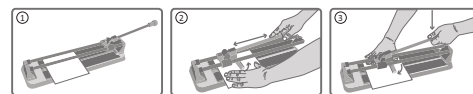

- Steel base • Special base reinforcement preventing deflection when cutting and breaking a tile Maximum thickness of cut tile 14 mm • Replacement disc - code 75722

Code	Cutting length (mm)	Base width (mm)	BOX	Cube
75540	400	180	x	2
75550	500	180	x	2
75560	600	180	x	2

**4 TILE CUTTING WHEEL**

• ЗАПАСНЫЕ РЕЖУЩИЕ РОЛИКИ • PAPILDOMAS RATUKAS PLYTELIŲ PLOVIMO ĮRANKIAMS



- Disc for tile-cutting tools - code 75850, 75860, 75870, 75880, 75900

Code	Dimension (mm)	BOX	Cube
75725	22 x 10.5 x 2	x	200

**5 SUPPORT RINGS FOR CUTTING WHEELS**

• НАБОР ПОДКЛАДОК ПОД РЕЖУЩЕЕ КОЛЕСО ДЛЯ ПЛИТКОРЕЗА • STÜTZRINGE FÜR TRENNSCHEIBEN



- Glaze cutter inserts - code 75850, 75860, 75870, 75880, 75900

Code	BOX	Cube
PKT001UW	x	250

Precisely made, PROLINE's durable brushes and rollers are irreplaceable when painting both large and smaller surfaces, for professionals and ambitious amateurs. With them you will achieve the intended effect easily and quickly. When choosing painting tools, pay attention to the three basic factors that determine the product to be used - the size of the painted surface, the type of paint and the type (structure) of the substrate.

**Surface area:**

Rollers 180 mm to 250 mm in length are recommended for painting large surfaces, such as walls or ceilings, as they allow you to collect a large quantity of paint at once, and make it possible to quickly and evenly cover the painted surface. In the case of smaller, flat surfaces, rolls with a length of 100 mm will work much better, making it easier to paint, for example, window recesses without using

too much paint, as well as allowing precise painting in hard-to-reach places. Brushes are definitely better for painting small surfaces, nooks and crannies or irregular surfaces and shapes.

ROLLER MODEL	AVAILABLE DIMENSIONS OF INSERTS (mm)							
	10x100	30x100	50x180	50x250	35x50	35x70	35x100	mini set*
WESTAN			x	x				
SYNTEX	x			x				x
NYLON	x	x	x	x				x
ELIKATOR	x			x				x
REX OLIWKA	x	x	x	x				x
MOLTOPREN					x	x	x	
WELUR	x	x						x
GIRPAINT	x							x

\* Two 10 x 100 mm covers, paint tray, and handle

ROLLER MODEL	PURPOSE									
	emulsion paints	latex paints	silicone paints	silicate paints	thixotropic paints	solvent-based varnishes	water-based varnishes	thick varnishes	two-component paints (epoxy polyester)	stains
WESTAN	x									
SYNTEX	x			x	x					
NYLON	x	x				x	x	x	x	x
ELIKATOR	x			x	x					
REX OLIWKA	x		x	x	x					
MOLTOPREN						x	x	x	x	x
WELUR	x	x				x	x	x	x	x
GIRPAINT	x			x	x					

**Substrate and paint type:**

The paint or varnish needs to be selected appropriately for the type of surface and the effect you want to achieve. Paint and varnish manufacturers provide detailed information on their packaging regarding their products, purpose, use and recommended painting tools. If such information is absent, knowing how to choose the right tool is very useful.

**Brushes** - when choosing a brush for painting pay special attention to the key part - the bristles. Brushes with natural bristles are made for solvent-based varnishes and paints, brushes with synthetic bristles for water-borne paints, while brushes with mixed bristles for both water-borne and oil-based paints or varnishes.

**Rollers** - The height of the nap should be matched to the painted surface's structure. A short nap is decidedly

better for painting very smooth surfaces, such as a gypsum-based finish. The more structural and porous the surface, the larger the nap on the roller should be, so rollers with a large nap are recommended for painting façades. The material from which the roller is made is also important. The uses of all PROLINE rollers are shown in the table above



Before starting, consider purchasing painting accessories that will simplify and speed up your work, so that painting becomes a pleasure, not a chore. It is a good idea to equip yourself with an appropriate size tray and grille, an extending pole for rollers that increase the range of movement, as well as a masking tape and film, which help you avoid drips during work or save time needed for cleaning afterwards.



Выполненные с высокой точностью, надежные кисти и валики PROLINE незаменимы при покраске больших и малых поверхностей профессионалами и любителями. С ними вы легко и быстро достигнете желаемого эффекта. При выборе инструментов для покраски обращайтесь внимание на три основных фактора, которые определяют используемый продукт - размер окрашиваемой поверхности, тип краски и тип (структура) подложки.

**Площадь поверхности:**

Валики длиной от 180 до 250 мм рекомендуется использовать для покраски больших поверхностей, таких как стены или потолки, поскольку они позволяют собирать за раз большое количество краски, а также быстро и равномерно покрыть окрашенную поверхность. Для небольших плоских поверхностей намного лучше подойдут валики длиной 100 мм, которыми будет более просто покрасить например

оконные ниши без использования слишком большого количества краски, а также выполнить покраску в труднодоступных местах. Для покраски небольших поверхностей, углов и закоулков или неправильных поверхностей и форм, безусловно, лучше подойдут кисти.

МОДЕЛЬ ВАЛИКА	ДОСТУПНЫ РАЗМЕРЫ ВКЛАДЫШЕЙ (мм)							
	10x100	30x100	50x180	50x250	35x50	35x70	35x100	zestaw mini*
WESTAN			x	x				
SYNTEX	x			x				x
НЕЙЛОН	x	x	x	x				x
ELIKATOR	x			x				x
REX OLIWKA	x	x	x	x				x
MOLTOPREN					x	x	x	
WELUR	x	x						x
GIRPAINT	x							x

\* Два вкладыша 10 x 100 мм, кювет и ручка

МОДЕЛЬ ВАЛИКА	ПРЕДНАЗНАЧЕНИЕ									
	эмульсионные краски	краски латексные	краски силиконовые	краски силикатные	краски тиксотропные	лаки на основе растворителя	лаки на базе воды	лаки густые	двухкомпонентные краски (эпоксидные, полиэфирные), морилки	
WESTAN	x									
SYNTEX	x			x	x					
НЕЙЛОН	x	x				x	x	x	x	x
ELIKATOR	x			x	x					
REX OLIWKA	x		x	x	x					
MOLTOPREN						x	x	x	x	x
WELUR	x	x				x	x	x	x	x
GIRPAINT	x			x	x					

**Тип подложки и краски:**

Краску или лак выбирают в соответствии с типом поверхности и желаемым эффектом. Производители красок и лаков предоставляют на упаковке подробную информацию по продуктам, назначению, использованию и рекомендуемым инструментам. Если такая информация отсутствует, полезно будет знать, как правильно выбрать инструмент.

**Кисти** - при выборе кисти особое внимание обращают на основную часть - щетину. Кисти с натуральной щетиной предназначены для лаков и красок на основе растворителей, кисти с синтетической щетиной используются для красок на водной основе, а кисти со смешанной щетиной - для красок и лаков на водной и масляной основе.

**Валики** - высота ворса должна соответствовать структуре окрашиваемой поверхности. Короткий ворс лучше подходит для покраски очень гладких

поверхностей, например, с гипсовой основой. Чем более структурная и пористая поверхность, тем больше должен быть ворс на валике, поэтому для покраски фасадов рекомендуются валики с большим ворсом. Также важен материал, из которого сделан валик. В предыдущей таблице показаны типы использования всех валиков PROLINE



Прежде чем приступить к покраске, необходимо приобрести соответствующие принадлежности, которые упростят и ускорят работу, чтобы покраска стала удовольствием, а не рутинной. Рекомендуется подготовить лоток и решетку подходящего размера, длинную рукоять для валиков, которая увеличивает диапазон перемещения, а также малярную ленту и пленку, которые защитят от капель во время работы или сэкономят время, необходимое для последующей уборки.



Präzise gefertigt sind die langlebigen Bürsten und Rollen von PROLINE sowohl beim Malen großer als auch kleiner Flächen unersetzlich und sowohl für Profis als auch ambitionierte Amateure geeignet. Mit ihnen erzielen Sie einfach und schnell die gewünschte Wirkung. Achten Sie bei der Auswahl der Malwerkzeuge auf die drei grundlegenden Faktoren, die bestimmen, welches Produkt verwendet werden muss - die Größe der bemalten

Oberfläche, die Art der Farbe und die Art (Struktur) des Untergrunds.

**Oberfläche:**

Für Malarbeiten auf großen Flächen wie Wänden oder Decken werden Rollen mit einer Länge von 180 mm bis 250 mm empfohlen, da damit eine große Farbmenge auf einmal aufgenommen werden kann und die bemalte Oberfläche schnell und gleichmäßig abdecken werden kann. Bei

kleineren, ebenen Flächen sind Rollen mit einer Länge von 100 mm wesentlich besser geeignet. Mit diesen können beispielsweise Fensteröffnungen ohne Verwendung von zu viel Farbe bemalt werden. Außerdem sind mit diesen Rollen Malarbeiten an schwer zugänglichen Stellen möglich. Pinsel eignen sich auf jeden Fall besser zum Bemalen von kleinen Flächen, Ecken und Winkeln oder unregelmäßigen Flächen und Formen.

ROLLENART	VERFÜGBARE GRÖSSEN DER EINSÄTZE (mm)							
	10x100	30x100	50x180	50x250	35x50	35x70	35x100	Satz Mini*
WESTAN			x	x				
SYNTEX	x			x				x
NYLON	x	x	x	x				x
ELIKATOR	x			x				x
REX OLIWKA	x	x	x	x				x
MOLTOPREN					x	x	x	
WELUR	x	x						x
GIRPAINT	x							x

\* Zwei Einsätze 10 x 100 mm, Farbwanne und Bügel

ROLLENART	BESTIMMUNG									
	Dispersionsfarben	Farbe, Latex	Farbe, Silikon	Farbe, Silikat	Farbe, thixotrop	Lacke auf Basis eines Lösungsmittels	Lacke auf Basis von Wasser	Lacke, zähflüssig	Zweikomponentenfarben (Epoxid-, Polyesterfarben)	Beizen
WESTAN	x									
SYNTEX	x			x	x					
NYLON	x	x				x	x	x	x	x
ELIKATOR	x			x	x					
REX OLIWKA	x		x	x	x					
MOLTOPREN						x	x	x	x	x
WELUR	x	x				x	x	x	x	x
GIRPAINT	x			x	x					

**Untergrund und Farbart:**

Sie müssen die Farbe oder den Lack entsprechend der Art der Oberflächen und entsprechend zu dem gewünschten Effekte auswählen. Hersteller von Farben und Lacken geben auf ihrer Verpackung detaillierte Informationen zu ihren Produkten, ihrem Verwendungszweck, ihrer Verwendung und den empfohlenen Malwerkzeugen. Falls solche Informationen nicht vorhanden sind, ist es sehr nützlich zu wissen, wie man das richtige Werkzeug auswählt.

**Pinsel** - bei der Auswahl eines Malpinsels muss besonders auf den Schlüsselteil geachtet werden - die Borsten. Pinsel mit Naturborsten sind für lösemittelhaltige Lacke und Farben bestimmt, Pinsel mit synthetischen Borsten für Wasserlacke und Pinsel mit gemischten Borsten sind sowohl für Wasser- als auch für Ölfarben oder Lacke bestimmt.

**Rollen** - Die Höhe des Flors muss an die Struktur der zu bemalenden Oberfläche angepasst werden. Ein kurzes Flor ist zweifelsohne besser geeignet für

das Bemalen von sehr glatten Oberflächen wie z. B. Oberflächen auf Gipsbasis. Je struktureller und poröser die Oberfläche ist, desto größer sollte der Flor auf der Walze sein. Daher empfehlen sich Walzen mit großem Flor für Fassadenanstriche. Das Material, aus dem die Walze hergestellt ist, ist ebenfalls wichtig. Die Verwendungsmöglichkeiten aller PROLINE-Rollen sind in der obigen Tabelle aufgeführt.



Bevor Sie mit der Arbeit beginnen, erwägen Sie doch den Kauf von Malzubehör, das Ihre Arbeit einfacher gestalten wird und so das Malen zum Vergnügen und nicht zur lästigen Pflicht macht. Es ist eine gute Idee, sich mit einer Farbwanne und einem Gitter mit entsprechender Größe auszustatten sowie mit einer ausziehbaren Stange für die Malerrollen, die den Bewegungsbereich vergrößert. Außerdem ist es sinnvoll, sich mit einem Abdeckband und einem Film auszurüsten, um das Tropfen der Farbe während der Arbeit zu vermeiden oder sich die Zeit für Aufräumarbeiten nach der Arbeit zu sparen.



**1 PAINT BRUSHES**

• ПЛОСКИЕ КИСТИ (ФЛЕЙЦЕВЫЕ) • ENGLISCHE PINSEL



- Quality natural hair TOPS 90 • Wooden, lacquered handle • Brushes recommended to oil-based paints and varnishes

Code	Width (mm)	Box
41100	1"	12/240
41101	1 1/2"	12/240
41102	2"	12/240
41103	2 1/2"	12/120
41104	3"	12/120

**2 PAINT BRUSHES**

• ПЛОСКИЕ КИСТИ (ФЛЕЙЦЕВЫЕ) • ENGLISCHE PINSEL



- 50%-50% blend of natural bristles and OREL® • Lacquered wooden handle
- Brushes recommended for water-based paints

Code	Width (mm)	Box
41106	1"	12/240
41107	1 1/2"	12/240
41108	2"	12/240
41109	2 1/2"	12/120
41110	3"	12/120

**3 PAINT BRUSHES**

• ПЛОСКИЕ КИСТИ (ФЛЕЙЦЕВЫЕ) • ENGLISCHE PINSEL



- High-quality natural bristle TOPS 90 • Two-component handle • Brushes designed for oil-based paints and varnishes

Code	Width (mm)	Box
41113	1"	12/240
41114	1 1/2"	12/240
41115	2"	12/240
41116	2 1/2"	12/120
41117	3"	12/120

**4 PAINT BRUSHES**

• ПЛОСКИЕ КИСТИ (ФЛЕЙЦЕВЫЕ) • ENGLISCHE PINSEL



- 50%-50% blend of natural bristle with polyester one • Two-component handle
- Brushes recommended for water-based paints

Code	Width (mm)	Box
41118	1"	12/240
41119	1 1/2"	12/240
41120	2"	12/240
41121	2 1/2"	12/120
41122	3"	12/120

**5 ANGLE PAINT BRUSHES**

• КИСТИ МАЛЯРНЫЕ УГЛОВЫЕ • WINKELPINSEL



- High-quality natural bristle TOPS 90
- Lacquered wooden handle • Brushes designed for oil-based paints and varnishes

Code	Width (mm)	Box
41111	2"	12/120
41112	2 1/2"	12/120

**6 ROLLERS WITH FRAME**

• РУЧКИ И ВАЛИКИ МАЛЯРНЫЕ WESTAN • GRIFFE MIT WESTAN-ROLLE



- Sleeve made from shaggy polyester yarn
- Recommended for easy painting works
- Recommended for emulsion and latex paints
- Handle with steel wire Ø 8 mm

Code	Dimension (mm)	Diameter (mm)	Quantity in the pack	Box
41142	50 x 180	8	1	40
41143	50 x 250	8	1	35

**7 ROLLERS WITH FRAME**

• РУЧКИ И ВАЛИКИ МАЛЯРНЫЕ NYLON • ROLLEN MIT RAHMEN



- Short 7 mm nap • Resistant to solvents
- Recommended for painting with oil nitro, chlorinated rubber, polyvinyl, corrosion protection, undercoat, two-component paints, as well as sticky substances such as polyester and epoxy resins • Handle with Ø 8 mm steel rod

Code	Dimension (mm)	Diameter (mm)	Quantity in the pack	Box
41150	50 x 180	8	1	40
41151	50 x 250	8	1	35

**8 ROLLERS WITH FRAME**

• РУЧКИ И ВАЛИКИ МАЛЯРНЫЕ ELIKATOR • ROLLEN MIT RAHMEN

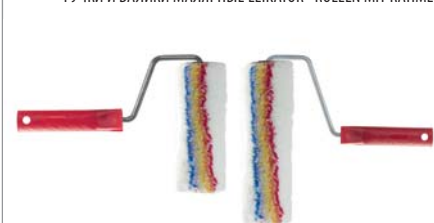

- Professional roller for painting porous and uneven façades • Nap made of densely woven fabric, highly resistant to abrasion • Nap 15 mm high • Recommended for painting with emulsion, acrylic, silicone and silicate paints
- For interior and exterior painting • Handle with Ø 8 mm steel rod

Code	Dimension (mm)	Diameter (mm)	Quantity in the pack	Box
41154	50 x 180	8	1	40
41155	50 x 250	8	1	35

**9 ROLLERS WITH FRAME**

• РУЧКИ И ВАЛИКИ МАЛЯРНЫЕ REX OLIWKA • ROLLEN MIT RAHMEN



- Roller designed for cost-efficient painting of large surfaces with emulsion and latex paints
- Façade roller padded with PP foam 6 mm thick, covered with a polyamide-acrylic fabric
- Recommended for painting internal and external walls with façade paints • Handle with Ø 8 mm steel rod

Code	Dimension (mm)	Diameter (mm)	Quantity in the pack	Box
41158	70 x 180	8	1	30
41159	70 x 250	8	1	25

PROLINE  
LANT PRO  
MEGA  
JUSO  
OTHER BRANDS  
ENDI  
KILNIGSPOR  
EXPRESS  
ACTION CAN  
TRYTON  
VALDAN

PROLINE

LANITI PRO

MEGA

JUCO

OTHER BRANDS

ERDI

KUNGSFOR

EXPRESS

ACTION CAN

TRAYTON

VULCAN

**1 ROLLERS WITH FRAME**

• РУЧКИ И ВАЛИКИ МАЛЯРНЫЕ SYNTAX • GRIFFE MIT SYNTAX-ROLLE



- All-purpose roller for professionals and ambitious amateurs
- Recommended for emulsion and latex paints
- Designed for economic coating of large areas
- Handle with steel wire Ø 8 mm

Code	Dimension (mm)	Diameter (mm)	Quantity in the pack	
41146	50 x 180	8	1	40
41147	50 x 250	8	1	35

**4 ROLLER WITH FRAME**

• РУЧКА И ВАЛИК МАЛЯРНЫЙ REX OLIWKA • GRIFF MIT REX OLIWKA ROLLE



- The roller is recommended for economic emulsion and latex paints
- Facade roller lined with PP foam 6 mm thick, covered with polyamide-acrylic textile
- Recommended for coating inner and outer walls with facade paints
- Long and lightweight handle with steel wire Ø 6 mm

Code	Dimension (mm)	Diameter (mm)	Quantity in the pack	
41253	30 x 100	6	1	50

**7 ROLLER WITH FRAME**

• РУЧКА И ВАЛИК МАЛЯРНЫЙ WELUR • GRIFF MIT WELUR-ROLLE



- The roller is designed for any varnishing works, is resistant to solvents
- Can be used with solvent-based varnishes, water-based ones, thick varnishes and two-ingredient paints - e.g. epoxy or polyester paints
- Long and lightweight handle with steel wire Ø 6 mm

Code	Dimension (mm)	Diameter (mm)	Quantity in the pack	
41248	30 x 100	6	1	50

**2 ROLLER WITH FRAME**

• РУЧКА И ВАЛИК МАЛЯРНЫЙ NYLON • GRIFF MIT NYLON-ROLLE



- Short pile 7mm
- Resistant to solvents
- Recommended for nitro oil paints, chlorinated rubber based paints, polyvinyl paints, anti-corrosion paints, primers, two-ingredient paints, as well as sticky paints e.g. polyester and epoxy resins
- Long and lightweight handle with steel wire Ø 6 mm

Code	Dimension (mm)	Diameter (mm)	Quantity in the pack	
41243	30 x 100	6	1	50

**5 ROLLER WITH FRAME**

• РУЧКА И ВАЛИК МАЛЯРНЫЙ SYNTAX • GRIFF MIT SYNTAX-ROLLE



- All-purpose roller for professionals and ambitious amateurs
- Recommended for emulsion and latex paints
- Long and lightweight handle with steel wire Ø 6 mm

Code	Dimension (mm)	Diameter (mm)	Quantity in the pack	
41268	30 x 100	6	1	50

**8 ROLLER WITH FRAME**

• РУЧКА И ВАЛИКИ МАЛЯРНЫЕ NYLON • GRIFF MIT NYLON-ROLLEN



- Short pile 7mm
- Resistant to solvents
- Recommended for nitro oil paints, chlorinated rubber based paints, polyvinyl paints, anti-corrosion paints, primers, two-ingredient paints, as well as sticky paints e.g. polyester and epoxy resins
- Short and lightweight handle with steel wire Ø 6 mm

Code	Dimension (mm)	Diameter (mm)	Quantity in the pack	
41242	10 x 100	6	2	75

**3 ROLLER WITH FRAME**

• РУЧКА И ВАЛИК МАЛЯРНЫЙ ELIKATOR • GRIFF MIT ELIKATOR-ROLLE



- Professional roller for coating porous and uneven facades
- The sleeve made from thick-woven textile, highly resistant to abrasion
- The pile 15mm high
- Recommended for emulsion, acrylic, silicon and silicate paints
- Long and lightweight handle with steel wire Ø 6 mm

Code	Dimension (mm)	Diameter (mm)	Quantity in the pack	
41258	30 x 100	6	1	50

**6 ROLLER WITH FRAME**

• РУЧКА И ВАЛИК МАЛЯРНЫЙ GIRPAINT • GRIFF MIT GIRPAINT-ROLLE



- Polyamide & acrylic roller with pile 9 mm
- Designed for smooth surfaces, i.e. gypsum, gypsuboard
- Recommended for coating with emulsion, latex, thixotropic and silicate paints
- Long and lightweight handle with steel wire Ø 6 mm

Code	Dimension (mm)	Diameter (mm)	Quantity in the pack	
41263	30 x 100	6	1	50

**9 ROLLER WITH FRAME**

• РУЧКА И ВАЛИКИ МАЛЯРНЫЕ ELIKATOR • GRIFF MIT ELIKATOR-ROLLEN



- Professional roller for coating porous and uneven facades
- The sleeve made from thick-woven textile, highly resistant to abrasion
- The pile 15mm high
- Recommended for emulsion, acrylic, silicon and silicate paints
- Short and lightweight handle with steel wire Ø 6 mm

Code	Dimension (mm)	Diameter (mm)	Quantity in the pack	
41257	10 x 100	6	2	75

**1 ROLLER WITH FRAME**

- РУЧКА И ВАЛИКИ МАЛЯРНЫЕ REX OLIWKA
- GRGRIFF MIT REX OLIWKA ROLLEN



- The roller is recommended for economic emulsion and latex paints • Facade roller covered with polyamide-acrylic textile
- Recommended for coating inner and outer walls with facade paints • Short and lightweight handle with steel wire Ø 6 mm

Code	Dimension (mm)	Diameter (mm)	Quantity in the pack	
41252	10 x 100	6	2	75

**2 ROLLER WITH FRAME**

- РУЧКА И ВАЛИКИ МАЛЯРНЫЕ SYNTAX • GRGRIFF MIT SYNTAX-ROLLEN



- All-purpose roller for professionals and ambitious amateurs • Recommended for emulsion and latex paints • Short and lightweight handle with steel wire Ø 6 mm

Code	Dimension (mm)	Diameter (mm)	Quantity in the pack	
41267	10 x 100	6	2	75

**3 ROLLER WITH FRAME**

- РУЧКА И ВАЛИКИ МАЛЯРНЫЕ GIRPAINT • GRGRIFF MIT GIRPAINT-ROLLEN



- Polyamide & acrylic roller with pile 9 mm
- Designed for smooth surfaces, i.e. gypsum, gypsuboard • Recommended for coating with emulsion, latex, thixotropic and silicate paints
- Short and lightweight handle with steel wire Ø 6 mm

Code	Dimension (mm)	Diameter (mm)	Quantity in the pack	
41262	10 x 100	6	2	75

**4 ROLLER WITH FRAME**

- РУЧКА И ВАЛИКИ МАЛЯРНЫЕ WELUR • GRGRIFF MIT WELUR-ROLLEN



- The roller is designed for any varnishing works, is resistant to solvents • Can be used with solvent-based varnishes, water-based ones, thick varnishes and two-ingredient paints - e.g. epoxy or polyester paints • Short and lightweight handle with steel wire Ø 6 mm

Code	Dimension (mm)	Diameter (mm)	Quantity in the pack	
41247	10 x 100	6	2	75

**5 HANDLE AND ROLLERS SLEEVE**

- ДЕРЖАТЕЛЬ И ВКЛАДЫШИ MOLTOPREN
- GRGRIFF UND MOLTOPREN-EINLAGEN



- The set includes one handle and 4 roller sleeves • The roller made from modified polyester foam designed for emulsion and oil paints, varnishes and joint compounds
- Thanks to its small size, designed for precision finishing works

Code	Dimension (mm)	Diameter (mm)	
41160	35 x 50	6	75
41161	35 x 70	6	75
41162	35 x 100	6	45

**6 MINI ROLLER KIT**

- МАЛЯРНЫЙ КОМПЛЕКТ МИНИ, ВКЛАДЫШИ NYLON
- MAMALERSET MINI, NYLON-EINLAGEN



- Short pile 7 mm • Resistant to solvents
- Recommended for nitro oil paints, chlorinated rubber based paints, polyvinyl paints, anti-corrosion paints, primers, two-ingredient paints, as well as sticky paints e.g. polyester and epoxy resins • The set includes short and lightweight handle with steel wire Ø 6 mm, 2 sleeves sized 100 x 10 mm and paint tray sized 140 x 190 mm

Code	Diameter (mm)	Quantity in the pack	
41244	6	2	25

**7 MINI ROLLER KIT**

- МАЛЯРНЫЙ КОМПЛЕКТ МИНИ, ВКЛАДЫШИ ELIKATOR
- MAMALERSET MINI, ELIKATOR-EINLAGEN



- Professional roller for coating porous and uneven facades • The sleeve made from thickwoven textile, highly resistant to abrasion
- The pile 15mm high • Recommended for emulsion, acrylic, silicon and silicate paints • The set includes: short and lightweight handle with steel wire Ø 6 mm, 2 sleeves sized 100 x 10 mm and a paint tray sized 140 x 190 mm

Code	Diameter (mm)	Quantity in the pack	
41259	6	2	25

**8 MINI ROLLER KIT**

- МАЛЯРНЫЙ КОМПЛЕКТ МИНИ, ВКЛАДЫШИ REX OLIWKA
- MAMALERSET MINI, REX OLIWKA EINLAGEN



- The roller is recommended for economic emulsion and latex paints • Facade roller, lined with PP foam 6 mm thick, covered with polyamide-acrylic textile • Recommended for coating inner and outer walls with facade paints • The set includes: short and lightweight handle with steel wire Ø 6 mm, 2 sleeves sized 100 x 10 mm and paint tray sized 140 x 190 mm

Code	Diameter (mm)	Quantity in the pack	
41254	6	2	25

**9 MINI ROLLER KIT**

- МАЛЯРНЫЙ КОМПЛЕКТ МИНИ, ВКЛАДЫШИ SYNTAX
- MAMALERSET MINI, SYNTAX-EINLAGEN



- All-purpose roller for professionals and ambitious amateurs • Recommended for emulsion and latex paints • The set includes: short and lightweight handle with steel wire Ø 6 mm, 2 sleeves sized 100 x 10 mm and paint tray sized 140 x 190 mm

Code	Diameter (mm)	Quantity in the pack	
41269	6	2	25

PROLINE

**1 MINI ROLLER KIT**

- МАЛЯРНЫЙ КОМПЛЕКТ МИНИ, ВКЛАДЫШИ GIRPAINT
- MALERSET MINI, GIRPAINT-EINLAGEN



- Polyamide & acrylic roller with pile 9mm
- Designed for smooth surfaces, i.e. gypsum, gypsuboard
- Recommended for coating with emulsion, latex, thixotropic and silicate paints
- The set includes short and lightweight handle with steel wire Ø 6 mm, 2 sleeves sized 100 x 10 mm and paint tray sized 140 x 190 mm

Code	Diameter (mm)	Quantity in the pack	
41264	6	2	25

LANITI PRO

MEGA

JUCO

**2 MINI ROLLER KIT**

- МАЛЯРНЫЙ КОМПЛЕКТ МИНИ, ВКЛАДЫШИ WELUR
- MALERSET MINI, WELUR-EINLAGEN



- The roller is designed for any varnishing works, is resistant to solvents
- Can be used with solvent-based varnishes, water-based ones, thick varnishes and two-ingredient paints - e.g. epoxy or polyester paints
- The set includes: short and lightweight handle with steel wire Ø 6 mm, 2 sleeves sized 100 x 10 mm and paint tray sized 140 x 190 mm

Code	Diameter (mm)	Quantity in the pack	
41249	6	2	25

OTHER BRANDS

ERDI

KUNGSFOR

EXPRESS

**3 ROLLER SLEEVES**

- ВАЛИКИ WESTAN • WESTAN-EINLAGEN



- The roller is recommended for emulsion and latex paints.
- The roller is made from shaggy polyester yarn knitwear
- Dedicated for simple painting works

Code	Dimension (mm)	Diameter (mm)	Quantity in the pack	
41140	50 x 180	8	1	50
41141	50 x 250	8	1	40

ACTION CAN

TRAYTON

VULCAN

**4 ROLLER SLEEVES**

- ВАЛИКИ NYLON • NYLON-EINLAGEN

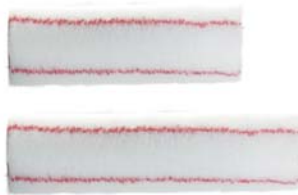

- Short pile 7mm
- Resistant to solvents
- For nitro oil paints, chlorinated rubber based paints, polyvinyl paints, anti-corrosion paints, primers, two-ingredient paints, as well as sticky paints e.g. polyester and epoxy resins

Code	Dimension (mm)	Diameter (mm)	Quantity in the pack	
41240	10 x 100	6	2	200
41241	30 x 100	6	1	200
41148	50 x 180	8	1	50
41149	50 x 250	8	1	40

**5 ROLLER SLEEVES**

- ВАЛИКИ ELIKATOR • ELIKATOR-EINLAGEN

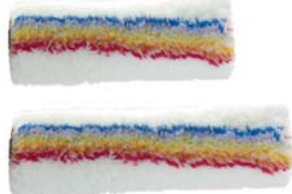

- Professional roller for coating porous and uneven facades
- The sleeve made from thickwoven textile, highly resistant to abrasion
- The pile 15mm high
- Recommended for emulsion, acrylic, silicon and silicate paints
- Recommended for inner and outer painting works

Code	Dimension (mm)	Diameter (mm)	Quantity in the pack	
41255	10 x 100	6	2	200
41256	30 x 100	6	1	200
41152	50 x 180	8	1	50
41153	50 x 250	8	1	40

**6 ROLLER SLEEVES**

- ВАЛИКИ REX OLIWKA • REX OLIWKA EINLAGEN

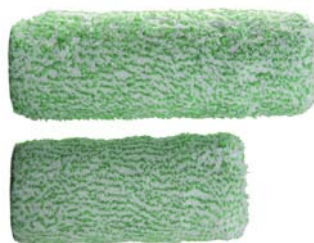

- Designed for coating large areas with emulsion and latex paints
- Facade roller with PP foam lining, 6mm thick, covered with polyamide and acrylic textile
- Designed for ambitious amateurs, recommended for coating inner and outer walls with facade paints

Code	Dimension (mm)	Diameter (mm)	Quantity in the pack	
41250	10 x 100	6	2	200
41251	30 x 100	6	1	200
41156	70 x 180	8	1	30
41157	70 x 250	8	1	25

**7 ROLLER SLEEVES**

- ВАЛИКИ SYNTAX • SYNTAX-EINLAGEN



- All-purpose roller for professionals and ambitious amateurs
- Recommended for emulsion and latex paints
- Dedicated for effective painting of large surfaces

Code	Dimension (mm)	Diameter (mm)	Quantity in the pack	
41265	10 x 100	6	2	200
41266	30 x 100	6	1	200
41144	50 x 180	8	1	50
41145	50 x 250	8	1	40

**8 ROLLER SLEEVES**

- ВАЛИКИ GIRPAINT • GIRPAINT-EINLAGEN

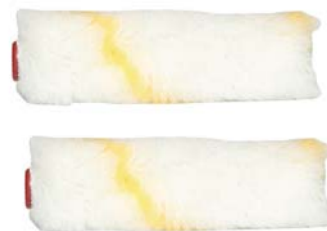

- Polyamide & acrylic roller 9mm
- Designed for smooth surfaces, i.e. gypsum, gypsuboard
- Recommended for coating with emulsion, latex, thixotropic and silicate paints

Code	Dimension (mm)	Diameter (mm)	Quantity in the pack	
41260	10 x 100	6	2	200
41261	30 x 100	6	1	200

**9 ROLLER SLEEVES**

- ВАЛИКИ WELUR • WELUR-EINLAGEN



- The roller is designed for any varnishing works
- Resistant to solvents
- Recommended for water-based varnishes, two-ingredient paints, epoxy and polyester paints

Code	Dimension (mm)	Diameter (mm)	Quantity in the pack	
41245	10 x 100	6	2	200
41246	30 x 100	6	1	200



**1 ROLLER SLEEVES**

• ВАЛИКИ МОЛТОПРЕН • MOLTOPREN-EINLAGEN

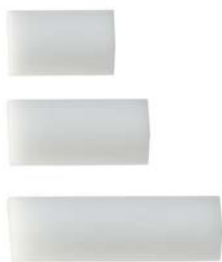

- Roller made from modified polyester foam, recommended for emulsion and oil paints, varnishes and joint compounds
- Thanks to its small size, designed for precision finishing works
- Sold in sets of 10 pcs.

Code	Dimension (mm)	Diameter (mm)	
41163	35 x 50	6	600
41164	35 x 70	6	500
41165	35 x 100	6	350

**2 HANDLES**

• РУЧКИ • GRIFF MIT NYLON-ROLLEN



- Lightweight plastic handle
- Steel wire Ø 6 mm

Code	Size (mm)	Diameter (mm)	
41168	50	6	140
41169	70	6	140
41170	100	6	120

**3 HANDLES**

• РУЧКИ • GRGRIFF



- Lightweight plastic handle
- Steel wire Ø 8 mm

Code	Size (mm)	Diameter (mm)	
41166	180	8	80
41167	250	8	50

**4 PAINT TRAYS**

• ВАННОЧКИ МАЛЯРНЫЕ • FARBWANNEN



- Plastic paint tray

Code	Dimension (mm)	
41171	120 x 190	500
41172	140 x 300	150
41173	240 x 320	50
41174	310 x 350	50

**5 PAINT CRATES**

• РЕШЁТКИ МАЛЯРНЫЕ • MALERGITTER

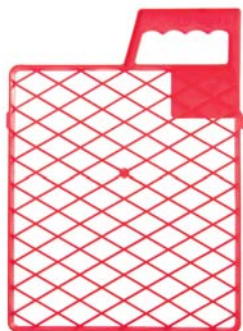

- Plastic paint mesh

Code	Dimension (mm)	
41175	180 x 210	350
41176	225 x 260	150
41177	260 x 310	100

**6 PLASTIC PAINT MESH**

• ВЁДРА МАЛЯРНЫЕ • MALEREIMER



- Rectangular plastic bucket
- Wire handle
- Dedicated to inner works
- The spout shaped in one of the corners

Code	Volume (l)	
41178	8	40
41179	12	20

**7 TELESCOPIC PAINT POLE**

• РУЧКА ТЕЛЕСКОПИЧЕСКАЯ МАЛЯРНАЯ • TELESKOPMALERS-TANGE



- For extending painter's tools

Code	Adjustment range (mm)	
41180	1000-2000	20

**8 PAINTER'S DUST SHEETS**

• ПЛЁНКИ МАЛЯРНЫЕ • MALERFOLIEN



- Painter's dust sheet sized 4 x 5 m

Code	Sheet type	Strength	Thickness (+/-10%) (µm)	
41136	HDPE	standard	0.7	40
41137	LDPE	strong	20	25
41138	LDPE	extra strong	40	10

**9 MASKING PAPER TAPES**

• ЛЕНТЫ МАЛЯРНЫЕ • MALERBAND



- Yellow paper tapes
- Roll length 35 m

Code	Diameter (mm)	
41131	19	12/48
41132	25	6/36
41133	30	10/40
41134	38	6/24
41135	48	6/24

PROLINE

LANITI PRO

MEGA

JUCO

OTHER BRANDS

ERDI

KLINGSPOR

EXPRESS

ACTION CAN

TRYTON

VULCAN

**1 TILE SPACERS**

• КРЕСТИКИ ДИСТАНЦИОННЫЕ • FUGENKREUZE



• Made from high quality materials

Code	Quantity in the packaging (pcs.)	Width (mm)	
61320	150	1,5	50
61321	150	2	50
61322	150	2,5	50
61323	100	3	50
61324	75	4	50
61325	75	5	50
61326	50	6	50
61327	30	8	50
61328	30	10	50

**2 TILE SPACERS WITH HOLDER**

• КРЕСТИКИ ДИСТАНЦИОННЫЕ С ДЕРЖАТЕЛЕМ  
• FUGENKREUZE MIT GRIFF



• Made from high quality materials • Small dimensional tolerance • Handle facilitating removal from the slot

Code	Quantity in the packaging (pcs.)	Width (mm)	
61329	100	1.5	50
61330	70	2	50
61331	70	2.5	50
61332	70	3	50
61333	70	4	50
61334	70	5	50
61335	50	6	50
61336	50	8	50
61337	40	10	50

**3 TILE WEDGES**

• КЛИНЬЯ МАЛЫЕ • KEKEILE, KLEIN



• Designed for tile levelling  
• Made from high quality materials

Code	Quantity in the packaging (pcs.)	Height/Width (mm)	
61344	100	23 x 5.3	200
61345	40	32.3 x 8	200

**4 TILE CUTTER**

• ЩИПЦЫ ДЛЯ РЕЗКИ ПЛИТКИ • FLIESENSCHNEIDZANGE



TIN COATED YG-6X 1x

• Designed for tile breaking and cutting  
• Cutting discs made from tungsten carbide YG-6X, coated with titanium • Coated handle to increase grip • The set includes • An allen wrench

Code	Length (mm)		
61661	200	x	6/48

**5 JOINT SCRUBBER**

• СКРЕБОК ДЛЯ ПЛИТОЧНЫХ ШВОВ • FUGENSCHABER



SOFT TOUCH

• Two-component handle ensures reliable grip  
• Efficient blades with tungsten grit for joint scrubbing

Code	Length blade (mm)		
61662	50	x	10/60



**6 JOINT SCRUBBER BLADES**

• СМЕННЫЕ ЛЕЗВИЯ ДЛЯ СКРЕБКА ДЛЯ ПЛИТОЧНЫХ ШВОВ  
• ERSATZKLINGEN FÜR FUGENSCHABER 61662



• Two effective tungsten-coated blades for grout removal • For scrubber 61662

Code	Length blade (mm)		
61663	50	x	50/400

**7 PROFILE SAMPLERS**

• ШАБЛОНЫ ГЕОМЕТРИЧЕСКИХ ФОРМ  
• FORMSCHABLONEN



24mm SCALE inch/cm

• Designed for mapping shapes in places difficult to reach • Graduation in inches and cm facilitating shape mapping

Code	Width (mm)		
61664	125	x	10/60
61665	250	x	10/40

**8 SPONGE**

• ГУБКА ДЛЯ ГЛАЗУРОВАНИЯ • FLIESENLEGERSCHWAMM



• The sponge is designed primarily for cleaning ceramic tiles after grouting, can be used also for washing and cleaning other surfaces

Code	Dimension (mm)	
61666	60 x 120 x 230	80

**1 REINFORCED CAULKING GUN**

- ПИСТОЛЕТ ДЛЯ ВЫДАВЛИВАНИЯ МАСС УСИЛЕННЫЙ
- KARTUSCHENPISTOLE VERSTÄRKT



225ml 225mm

- Designed for extrusion of silicone, glue and mass with increased density in tubes 225 mm long
- Double guide ensuring precise piston guiding

Code	Size (mm)	
18008	225	6/12

**2 CAULKING GUN**

- ПИСТОЛЕТ ДЛЯ ВЫДАВЛИВАНИЯ ГЕРМЕТИЧЕСКОЙ МАССЫ
- KARTUSCHENPISTOLE HALBSCHALE



300ml 225mm

- Steel
- Ratchet gear
- Handle covered with non-slip material

Code	Size (mm)	
18004	225	24

**3 CAULKING GUN**

- ПИСТОЛЕТ ДЛЯ ВЫДАВЛИВАНИЯ ГЕРМЕТИЧЕСКОЙ МАССЫ
- SKELETTKARTUSCHENPISTOLE



300ml 225mm

- Steel and aluminium
- Revolving tube holder

Code	Size (mm)	
18007	225	24

**4 CAULKING GUN**

- ПИСТОЛЕТ ДЛЯ ВЫДАВЛИВАНИЯ ГЕРМЕТИЧЕСКОЙ МАССЫ
- SKELETTKARTUSCHENPISTOLE



300ml 225mm

- Designed for extrusion of silicone and glue in tubes 225 mm long
- Frame made from steel flat section 2.5 mm thick

Code	Size (mm)	
18003	225	24

**5 ALUMINIUM CAULKING GUN**

- ПИСТОЛЕТ ДЛЯ ВЫДАВЛИВАНИЯ ГЕРМЕТИЧЕСКОЙ МАССЫ АЛЮМИНИЕВЫЙ
- ALALU-KARTUSCHENPISTOLE



600ml 370mm AL

- Aluminium and steel caulking gun for sealing compound 600 ml
- Designed for dispensing glue and sealants in plastic packages, up to 600ml and cartouches 290-310ml
- Durable and lightweight
- Rotating tube holder
- Strong ratchet mechanism
- Screwed-on tip
- Pusher 10mm thick
- Aluminium container

Code	Size (mm)	
18010	370	20

**6 ALUMINIUM CAULKING GUN**

- ПИСТОЛЕТ ДЛЯ ВЫДАВЛИВАНИЯ ГЕРМЕТИЧЕСКОЙ МАССЫ АЛЮМИНИЕВЫЙ
- ALU-KARTUSCHENPISTOLE



300ml 225mm AL

- Aluminium container
- Ratchet mechanism

Code	Size (mm)	
18009	225	24

**7 FOAM GUN**

- ПИСТОЛЕТ ДЛЯ МОНТАЖНОЙ ПЕНЫ
- SCHAUMPISTOLE



PTFE

- Aluminium head
- Ring and ball inside the head, made from PTFE, used as a check valve
- Knob facilitating accurate control of foam stream
- Brass nozzle
- Stainless steel needle
- Lightweight body made from zinc alloy - galvanised
- Two tips for application in places difficult to reach

Code	Size (mm)	
18016	340	20

**8 FOAM GUN**

- ПИСТОЛЕТ ДЛЯ МОНТАЖНОЙ ПЕНЫ
- SCHAUMPISTOLE



PTFE

- Brass head and nozzle
- Brass knob facilitating accurate control of foam stream
- Stainless steel needle
- Two tips for application in places difficult to reach

Code	Size (mm)	
18015	330	10/20

PROLINE

LAHTI PRO

MEGA

JUCO

OTHER BRANDS

ERDI

KLINGSPOR

EXPRESS

ACTION CAN

TRYTON

VULCAN

**1 FOAM GUN**

• ПИСТОЛЕТ ДЛЯ МОНТАЖНОЙ ПЕНЫ • SCHAUMPISTOLE

PROLINE HD



PTFE



- Body and handle made from nickel-coated aluminium alloy - satin coating
- Two tips for application in places difficult to reach

Code	Size (mm)	
18017	340	20

**2 FOAM GUN**

• ПИСТОЛЕТ ДЛЯ МОНТАЖНОЙ ПЕНЫ • SCHAUMPISTOLE



METAL



- Metal body • Knob for foam stream control

Code	Size (mm)	
18013	340	20

**3 FOAM GUN**

• ПИСТОЛЕТ ДЛЯ МОНТАЖНОЙ ПЕНЫ • SCHAUMPISTOLE



PTFE



- Metal body • Knob for foam stream control
- Head and applicator covered with PTFE - to facilitate gun cleaning

Code	Size (mm)	
18014	340	20



**1 F-TYPE CLAMPS WITH RATCHET**

- СТОЛЯРНЫЕ СТРУБЦИНЫ, ТИП F С ХРАПОВЫМ МЕХАНИЗМОМ
- ZWINGE MIT RATSCHKE

PROLINE HD®



AL HRC 45±2

- Ratchet drive enabling to clamp the item quickly
- Guide and arm - moving, forged
- Handle made from aluminium alloy

Code	Dimension (mm)	☐
11420	200 x 140	2/8
11430	300 x 140	2/8
11440	400 x 140	2/6
11450	500 x 140	2/6
11460	600 x 140	2/6

**2 F-TYPE CLAMPS WITH LOCK**

- СТОЛЯРНЫЕ СТРУБЦИНЫ, ТИП F, С БЛОКИРОВКОЙ
- ZWINGE TYP F MIT VERRIEGELUNG



HRC 25±2

- Lock minimising jaw falling risk
- Clamping screw with trapezoidal thread
- Plastic overlays protecting the material clamped

Code	Dimension (mm)	☐
11515	150 x 50	25/50
11525	250 x 50	25/50
11530	300 x 80	10/20
11531	300 x 120	5/10
11550	500 x 120	5/10
11580	800 x 120	6
11581	1000 x 120	6
11582	1500 x 120	4
11583	2000 x 120	4

**3 F-TYPE CLAMPS**

- СТОЛЯРНЫЕ СТРУБЦИНЫ, ТИП F - ZWINGE TYP F



- Quick action
- Cast iron arms
- Wooden handle
- Strip - steel, toothed, ensuring reliable sliding and locking
- Plastic jaw overlays protecting clamped material against damage

Code	Dimension (mm)	☐
11215	150 x 50	50
11230	300 x 50	50
11232	300 x 80	25
11231	300 x 120	10
11251	500 x 120	10
11281	800 x 120	6
11282	1000 x 120	6
11283	1500 x 120	5
11284	2000 x 120	5

**4 QUICK ACTION CLAMPS**

- СТОЛЯРНЫЕ СТРУБЦИНЫ, ОДНОРУЧНЫЕ - EINHANDZWINGEN



- Plastic
- Quick action
- After jaw resetting, can be used as a distancing tool

Code	Dimension (mm)	☐
11315	150 x 60	6/24
11320	200 x 60	6/24
11330	300 x 60	6/24
11345	450 x 60	6/24
11360	600 x 60	6/24
11375	750 x 60	6/12
11390	900 x 60	6/12



PROLINE  
LAHTI PRO  
MEGA  
JUCO  
OTHER BRANDS  
ERDI  
KLINGSPOR  
EXPRESS  
ACTION CAN  
TRYTON  
VULCAN

**1 „TURBO” HAND SAWS**

• НОЖОВКИ TURBO • FUCHSSCHWANZSÄGEN - TURBO



**TURBO CUT**

**HRC 52±2**

- Aggressive teeth with 3 ground cutting edges for quick cutting
- Two-component handle made from plastic with non-slip insert
- For rough cutting of wood and chipboard

Code	Size (mm)	Qty of teeth/ inch	Box
64340	400	7	12/48
64345	450	7	12/48
64350	500	7	12/24

**2 „TURBO” HAND SAWS**

• НОЖОВКИ TURBO • FUCHSSCHWANZSÄGEN - TURBO



**TURBO CUT**

**HRC 52±2**

- Aggressive teeth with 3 ground cutting edges for quick cutting
- Two-component handle made from plastic with non-slip insert
- For quick finishing cutting, for wood, chipboard, plywood, laminate and plastic

Code	Size (mm)	Qty of teeth/ inch	Box
64440	400	10	12/48
64445	450	10	12/48
64450	500	10	12/24

**3 „TURBO” HAND SAWS**

• НОЖОВКИ TURBO • FUCHSSCHWANZSÄGEN - TURBO



**TURBO CUT**

**PTFE**

**HRC 52±2**

- Aggressive teeth with 3 ground cutting edges for quick cutting
- Two-component handle made from plastic with non-slip insert
- PTFE-coated, offering small resistance in the process of cutting
- For quick, rough cutting of wood and chipboard

Code	Size (mm)	Qty of teeth/ inch	Box
64360	400	7	12/48
64365	450	7	12/48
64370	500	7	12/24

**4 HAND SAWS**

• НОЖОВКИ • RANKINIAI PŪKLAI

**HRC 52±2**



- Two-component handle made from plastic with non-slip insert
- For rough cutting of wood and chipboard

Code	Size (mm)	Qty of teeth/ inch	Box
64740	400	7	12/48
64745	450	7	12/48
64750	500	7	12/24

**5 HAND SAWS**

• НОЖОВКИ • FUCHSSCHWANZSÄGEN

**HRC 52±2**



- Two-component handle made from plastic with non-slip insert
- For finishing cutting, for wood, chipboard, plywood, laminate and plastic

Code	Size (mm)	Qty of teeth/ inch	Box
64840	400	10	12/48
64845	450	10	12/48
64850	500	10	12/24

**6 „TURBO” HAND SAWS**

• НОЖОВКИ TURBO • FUCHSSCHWANZSÄGEN - TURBO



**TURBO CUT**

**HRC 52±2**



- Wooden handle with rubber overlay
- For quick finishing cutting, for wood, chipboard, plywood, laminate and plastic

Code	Size (mm)	Qty of teeth/ inch	Box
64390	400	10	12/24
64391	450	10	12/24
64392	500	10	12/24

**7 BACK SAWS**

• ШЛИЦОВКИ • FEINSÄGE



**HRC 52±2**

- Two-component handle made from plastic with non-slip insert
- For finishing cutting, for wood, chipboard, plywood, laminate and plastic

Code	Size (mm)	Qty of teeth/ inch	Box
64400	300	10	12/48
64405	350	12	12/48

**8 SAWS FOR CELLULAR CONCRETE**

• НОЖОВКИ ДЛЯ ГАЗОБЕТОНА • SÄGEN FÜR LEICHTBETONSTEINE

**HRC 52±2**



- Large teeth
- Every second tooth made from sintered carbide

Code	Size (mm)	Total number of teeth	Number of carbide teeth	Box
64560	600	35	17	5/20
64570	700	39	19	5/20

**9 WALL BOARD SAW**

• НОЖОВКА ДЛЯ ГИПСОКАРТОННЫХ ПЛИТ • GIPSKARTONSÄGEN



**HRC 52±2**

- Two-component handle made from non-slip material
- Replaceable blade

Code	Size (mm)	Qty of teeth/ inch	Box
64460	150	7	10/60

**10 WALL BOARD SAW**

• НОЖОВКА ДЛЯ ГИПСОКАРТОННЫХ ПЛИТ • GIPSKARTONSÄGEN



**HRC 52±2**

- Two-sided teeth sharpening
- Teeth induction quenching
- Blade for easy cutting of a hole

Code	Size (mm)	Qty of teeth/ inch	Box
64465	150	10	10/60

**11 COMPASS SAW**

• УЗКАЯ НОЖОВКА • HAND-STICHSÄGE



**HRC 52±2**

- Two-component handle made from plastic with non-slip insert

Code	Size (mm)	Qty of teeth/ inch	Box
64420	300	7	10/60

**12 UNIVERSAL SAW**

• САДОВАЯ СКЛАДНАЯ НОЖОВКА • UNIVERSAL SÄGE



**HRC 52±2**

- Aggressive teeth with 3 ground cutting edges for quick cutting
- Two-component handle made from plastic with non-slip insert
- Replaceable blade

Code	Size (mm)	Qty of teeth/ inch	Box
64470	180	7	12/48

**1 BOW SAWS**

• ЛУЧКОВЫЕ ПИЛЫ • BÜGELSÄGE



**HRC**  
52±2

- Flattened frame • American teeth, quenched

Code	Size (mm)	
64053	530	24
64061	610	24
64076	760	24

**2 BLADES FOR BOW SAW**

• ПОЛОТНА ДЛЯ ЛУЧКОВОЙ ПИЛЫ  
• SÄGEBLÄTTER FÜR BÜGELSÄGEN



- American, induction-quenched teeth
- For saws: 64053, 64061, 64076

Code	Size (mm)	
64105	530	50/200
64106	610	50/200
64107	760	50/200

**3 BOW SAW**

• БУГЕЛЬНАЯ ЛУЧКОВАЯ ПИЛА • BÜGELSÄGE



**HRC**  
52±2

- The set includes 3 blades: for wood, metal and PVC

Code	Size (mm)	
64433	300	24

**4 BOW SAW**

• БУГЕЛЬНАЯ ЛУЧКОВАЯ ПИЛА  
• BÜGELSÄGE



- Supplied with 2 blades: for wood - with American, induction-quenched teeth and for metal and PVC, made from carbon steel
- Hand cover

Code	Size (mm)	
64132	300	12/24

**5 HACKSAW FRAME WITH ADJUSTABLE BOW**

• БУГЕЛЬНАЯ ЛУЧКОВАЯ ПИЛА ПО МЕТАЛЛУ • METALLBÜGELSÄGE MIT VERSTELLBAREM BÜGEL



- Structure enables to turn the bow and cut in places difficult to reach • Two methods of bow fixing

Code	Size (mm)	Qty of teeth/ inch	
23121	300	24	6/36

**6 HACKSAW FRAME**

• НОЖОВКА ПО МЕТАЛЛУ • METALLBÜGELSÄGE



**AL**

- Two blade positions • Aluminium handle
- Compartment for spare blades

Code	Size (mm)	
23120	300	6/48

**7 HACKSAW FRAME**

• БУГЕЛЬНАЯ ЛУЧКОВАЯ ПИЛА ПО МЕТАЛЛУ  
• METALLBÜGELSÄGE



**BI-METAL**

- Frame made from steel flat section 7 mm thick • Wooden, varnished handle • Two methods of blade fixing

Code	Size (mm)	Qty of teeth /inch	
23123	300	24	12



PROLINE

LAHTI PRO

MEGA

JUCO

OTHER BRANDS

ERDI

KUNGSFOR

EXPRESS

ACTION CAN

TRAYTON

VULCAN

**1 STRAIGHT SPADE, METAL SHAFT**

• Штыковая прямоугольная лопата, стальная рукоятка • GERADER SPATEN, METALLSTIEL



- Plastic-coated shaft
- Coated with hammer-effect varnish
- Ergonomic two-composite handle

**HRC**  
45±2

Code	Dimension (mm)	Box
14371	1150 x 195 x 290	6

**6 STRAIGHT SPADE, FIBREGLASS SHAFT**

• Штыковая прямоугольная лопата, ручка из стекловолокна • GERADER SPATEN, GLASFASERSTIEL



- Improved shaft resistance

**HRC**  
45±2

Code	Dimension (mm)	Box
12377	1150 x 180 x 280	6

**2 SHARP SPADE, METAL SHAFT**

• Штыковая лопата, металлическая ручка, премиум • SPITZER SPATEN, METALLSTIEL

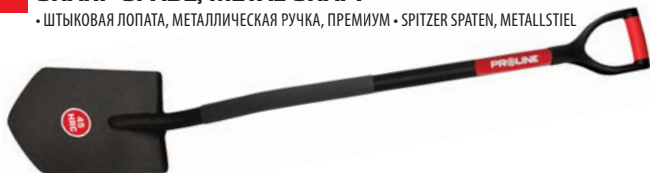

- Plastic-coated shaft
- Coated with hammer-effect varnish
- Ergonomic two-composite handle

**HRC**  
45±2

Code	Dimension (mm)	Box
14372	1150 x 190 x 290	6

**7 SHARP SPADE, WOODEN SHAFT**

• Штыковая лопата, деревянная ручка • SPITZER SPATEN, HOLZSTIEL



**HRC**  
45±2

Code	Dimension (mm)	Box
12375	1150 x 180 x 280	6

**3 SAND SHOVEL, METAL SHAFT**

• Лопата для песка с металлическим черенком, премиум • SANDSCHAUFEL, METALLSTIEL



- Shaft coated with plastic
- Coated with hammer-effect varnish
- Ergonomic two-composite handle

**HRC**  
45±2

Code	Dimension (mm)	Box
14373	1250 x 230 x 320	6

**8 SHARP SPADE, METAL SHAFT**

• Штыковая лопата, металлическая ручка • SPITZER SPATEN, METALLSTIEL



- Shaft coated with plastic

**HRC**  
45±2

Code	Dimension (mm)	Box
12372	1150 x 190 x 290	6

**4 STRAIGHT SPADE, WOODEN SHAFT**

• Штыковая прямоугольная лопата, деревянная ручка • GERADER SPATEN, HOLZSTIEL

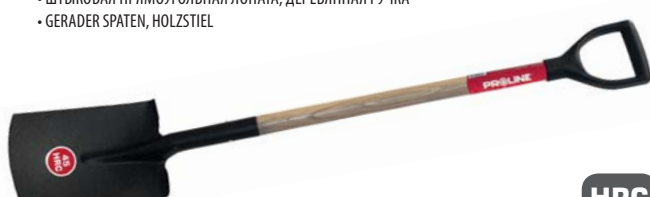

**HRC**  
45±2

Code	Dimension (mm)	Box
12374	1150 x 180 x 280	6

**9 SHARP SPADE, FIBREGLASS SHAFT**

• Штыковая лопата, ручка из стекловолокна • SPITZER SPATEN, GLASFASERSTIEL



- Improved shaft resistance

**HRC**  
45±2

Code	Dimension (mm)	Box
12378	1150 x 180 x 280	6

**5 STRAIGHT SPADE, METAL SHAFT**

• Штыковая прямоугольная лопата, металлическая ручка • GERADER SPATEN, METALLSTIEL

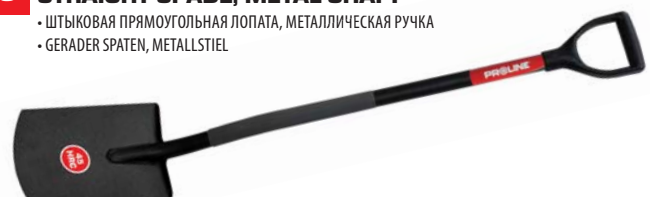

- Shaft coated with plastic

**HRC**  
45±2

Code	Dimension (mm)	Box
12371	1150 x 190 x 290	6

**10 SAND SHOVEL, WOODEN SHAFT**

• Совковая лопата, деревянная ручка • SANDSCHAUFEL, HOLZSTIEL

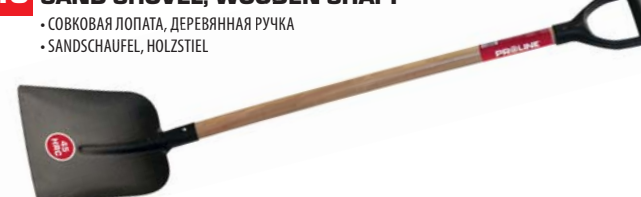

- Improved shaft resistance

**HRC**  
45±2

Code	Dimension (mm)	Box
12376	1250 x 250 x 280	6



**1 SAND SHOVEL, METAL SHAFT**

- СОВКОВАЯ ЛОПАТА, МЕТАЛЛИЧЕСКАЯ РУЧКА
- SANDSCHAUFEL, METALLSTIEL



- Shaft coated with plastic

**HRC**  
45±2

Code	Dimension (mm)	
12373	1250 x 230 x 320	6

**2 SAND SHOVEL, FIBREGLASS SHAFT**

- СОВКОВАЯ ЛОПАТА, РУЧКА ИЗ СТЕКЛОВОЛОННА
- SANDSCHAUFEL, GLASFASERSTIEL



- Improved shaft resistance

**HRC**  
45±2

Code	Dimension (mm)	
12379	1250 x 250 x 280	6

**3 ALUMINIUM SAND SHOVEL, EXTRA LIGHT**

- АЛЮМИНИЕВАЯ СОВКОВАЯ ЛОПАТА, СУПЕР ЛЁГКАЯ
- ALU-SCHAUFEL, EXTRA LEICHT



- Excellent ergonomics

1,0 **AL**

Code	Dimension (mm)	
12391	1230 x 250 x 320	12



**4 AXES**

- ТОПОРЫ • ÄXTE

PROLINE HD®



- Forged and quenched head, covered with non-stick Teflon coat
- Shaft made from composite reinforced with glass fiber
- Non-slip TPR handle • Model 12840-12854 - special blade shape facilitating trunk cleaving • Model 12836 - universal blade for preparing small wood pieces • Practical case for storage and transport

Code	Weight (g)	Length (mm)	
12836	640	360	12/24
12840	1000	455	6/12
12843	1300	605	6/12
12846	1600	725	4/8
12854	2400	775	2/4

**5 AXES**

- ТОПОРЫ • ÄXTE

PROLINE HD®



GENUINE HICKORY **DIN 5131** **DIN 7294**

- Forged and quenched head • Shaft and head connection by a wooden wedge and steel bushing • Rubber blade protection • Varnished shaft, made from American hickory hardwood • Rough, non-slip handle

Code	Weight (g)	Length (mm)	
12726	600	360	24
12728	800	380	24
12731	1000	430	16
12732	1250	700	10
12734	1400	700	10
12736	1600	800	10

**6 SPLITTING AXES**

- ТОПОРЫ • КОЛУНЫ • SPALTÄXTE

PROLINE HD®



GENUINE HICKORY

- Forged and quenched head • Special blade shape facilitating trunk cleaving
- Shaft and head connection by a wooden wedge and steel bushing • Rubber blade protection • Varnished shaft, made from American hickory hardwood
- Rough, non-slip handle

Code	Weight (g)	Length (mm)	
12741	1000	430	12
12742	2000	800	6

PROLINE

**1 AXES**  
• ТОПОРЫ • ÄXTE



**DIN 7287** **HRC 52±2**

- Forged and quenched head • Rubber blade guard

Code	Weight (g)	Length (mm)	☐
12706	600	360	24
12708	800	380	24
12710	1000	430	16
12712	1250	700	10
12716	1600	800	10

LAHTI PRO

MEGA

**2 AXES**  
• ТОПОРЫ • ÄXTE



**75% GRP** **DIN 7287** **HRC 52±2**

- Forged and quenched head • Rubber blade protection • Two-composite, non-slip TPR handle

Code	Weight (g)	Length (mm)	☐
12866	600	360	24
12868	800	380	24
12870	1000	430	24
12872	1250	700	12
12876	1600	800	12

JUCO

OTHER BRANDS

**3 AXES**  
• ТОПОРЫ • ÄXTE



**GRP** **DIN 7287** **HRC 52±2**

- Rubber blade guard • Non-slip TPR handle

Code	Weight (g)	Length (mm)	☐
12806	600	360	20
12808	800	380	20
12810	1000	430	16
12812	1250	700	8
12816	1600	800	6
12820	2000	900	6

ERDI

KUNGSFOR

EXPRESS

**4 SPLITTING AXE**  
• КОЛУН • SPALTAXT



**GRP** **HRC 52±2**

- Special blade shape facilitating trunk cleaving • Forged and quenched head • Non-slip TPR handle • Rubber blade protection

Code	Weight (g)	Length (mm)	☐
12821	2000	800	6

TRAYTON

VULCAN



**5 SPLITTING MAUL**  
• ТОПОР - КОЛУН • SPALTHAMMER



**2,7 kg** **70% GRP**

- Forged and quenched heat treated • Rubber collar protecting the handle against damage • Rubber blade protection
- Shaft made of high quality fiberglass • Cone-shaped shaft
- Two-composite, non-slip TPR handle

Code	Weight (g)	Length (mm)	☐
12825	2700	900	6

**6 SPLITTING MAUL**  
• ТОПОР - КОЛУН • SPALTHAMMER

PROLINE HD



**3,0 kg** **GENUINE HICKORY** **DIN 5129**

- Forged and quenched head • Shaft and head connection by a wooden wedge and two steel bushings • Protection cover for the blade made from artificial leather • Varnished shaft, made from American hickory hardwood • Rough, non-slip handle

Code	Weight (g)	Length (mm)	☐
12803	3000	900	6

**1 FLAT COLD CHISELS**

• ЗУБИЛА С ПРОТЕКТОРОМ  
• MAURERMEISSEL MIT SCHUTZ



**HRC**  
48±2

- Quenched • High-quality tool steel
- PVC cover

Code	Length (mm)	Width (mm)	
31325	250	16	5/50
31330	300	16	5/50
31339	300	19	5/20
31340	400	19	5/20

**2 POINT COLD CHISELS**

• КЕРНЫ С ПРОТЕКТОРОМ  
• LOCHWEISEN MIT SCHUTZ



**HRC**  
48±2

- Quenched • High-quality tool steel
- PVC cover

Code	Length (mm)	
31350	250	5/50
31353	300	5/20
31355	400	5/20

**3 WRECKING BARS**

• ГВОЗДОДЕРЫ • NAGELWEISEN



**HRC**  
49±3

Code	Length (mm)	Width (mm)	
31364	400	17	5
31365	500	17	5
31366	600	17	5
31367	700	17	5
31368	800	19	5
31370	1000	19	5

**4 POINT CROWBARS**

• СТРОИТЕЛЬНЫЕ ЛОМЫ • BAUBRECHSTANGEN



**HRC**  
49±3

Code	Length (mm)	Width (mm)	
31372	1200	25	4
31373	1500	25	4
31374	1600	25	3

**5 CHISEL AND PUNCH SET**

• НАБОР ПРОБОЙНИКОВ, ЗУБИЛ И КЕРНЕРОВ • AUSTREIBDORNE-, MEISSEL- UND KÖRNERSAETZE



**CrV** **HRC**  
55±2

- Plastic tool organizer
- The set contains:
  - Center punch: 100 mm x 6 mm, 115 mm x 8 mm
  - taper pin punch 140 mm x 2 mm
  - Chisels: 140 mm x 10 mm, 150 mm x 12 mm, 170 mm x 16 mm
  - Parallel punches: 150 mm x 8 mm, 150 mm x 6 mm, 150 mm x 5 mm, 150 mm x 4 mm, 150 mm x 3 mm, 150 mm x 1.5 mm

Code	Quantity (pcs.)		
31361	12	x	3/12

**6 CHISEL AND PUNCH SET**

• НАБОР ПРОБОЙНИКОВ, ЗУБИЛ И КЕРНЕРОВ • AUSTREIBDORNE-, MEISSEL- UND KÖRNERSAETZE



**CrV** **HRC**  
55±2

- Plastic tool organizer
- The set contains:
  - center punch 115 mm x 8 mm
  - taper pin punch 140 mm x 2 mm
  - Chisels: 140 mm x 10 mm, 150 mm x 12 mm
  - Parallel punches: 150 mm x 6 mm, 150 mm x 3 mm

Code	Quantity (pcs.)		
31362	6	x	3/24

**7 CHISEL AND PUNCH SET**

• НАБОР ПРОБОЙНИКОВ, ЗУБИЛ И КЕРНЕРОВ • AUSTREIBDORNE-, MEISSEL- UND KÖRNERSAETZE



**CrV** **HRC**  
52±2

- Chromium-plated • Polished • Plastic tool organizer
- The set contains:
  - center punch 120 mm x 4mm
  - taper pin punch 120 mm x 3 mm
  - Star-pointed chisel 130 mm x 5 mm
  - Flat chisel 130 mm x 12 mm
  - Parallel punches 150 mm x 4 mm

Code	Quantity (pcs.)		
31360	5	x	5/40

**8 CHISEL SET**

• НАБОР ЗУБИЛ • MEISSEL-SATZ



**CrV** **HRC**  
55±2

- Plastic tool organizer • The set contains:
  - center punches: 140mm x 10mm, 150mm x 12mm, 170mm x 16mm

Code	Quantity (pcs.)		
31363	3	x	3/24

**9 COLD CHISEL**

• ЗУБИЛО • MEISSEL



**CrV** **HRC**  
55±2

Code	Dimensions (mm)		
31358	150 x 12	x	3/24

PROLINE

LAHTI PRO

MEGA

JUCO

OTHER BRANDS

ERDI

KLINGSPOR

EXPRESS

ACTION CAN

TRYTON

VULCAN

**1 PIN PUNCH**

• ПРОБОЙНИК • AUSTREIBDORN



**CrV** **HRC**  
55±2

Code	Dimensions (mm)	Box	Box
31352	150 x 4	x	3/24

**2 TAPER PUNCH**

• ДОБОЙНИК • DURCHTREIBER



**CrV** **HRC**  
55±2

Code	Dimensions (mm)	Box	Box
31354	140 x 2	x	3/24

**3 CENTER PUNCH**

• КЕРНЕР • KÖRNER



**CrV** **HRC**  
55±2

Code	Dimensions (mm)	Box	Box
31356	100 x 6	x	3/24

**4 CENTER PUNCH**

• КЕРНЕР • KÖRNER



**CrV** **HRC**  
44±2

- Made from high quality materials, CrV steel
- Clip handle enabling to hang on a garment pocket • Diameter 8 mm • Packed in a blister • For marking stone, metal, metal sheets

Code	Dimensions (mm)	Box	Box
31385	125 x 8	x	12/96

**5 MARKING TOOL**

• ЧЕРТИЛКА РАЗМЕТОЧНАЯ • REISSNADEL CARBONSTAHL



- Made from high-quality HM steel, blade from TCT sintered carbide • Rubber blade protection preventing accidental cutting or damage
- Clip handle enabling to hang on a garment pocket • Hexagonal quenched 20HRC handle
- Blade protected with plastic casing
- For marking tiles, stone, glass, steel

Code	Length (mm)	Box	Box
31382	145	x	24/144

**6 PUNCH SETS**

• НАБОР ПРОБОЙНИКОВ ДЛЯ КОЖИ • LOCHSEISÄTZE FÜR LEDER



- For cutting holes in various materials
- Sets available in the following sizes: **32020**: 2.5, 3.0, 4.0, 5.0, 6.0, 7.0, 8.0, 9.0, 10.0 mm
- **32021**: 2.0, 2.5, 3.2, 4.0, 4.8, 5.5, 6.4, 8.0, 9.5, 11.1, 12.7, 14.0, 15.8, 19.0, 22.0 mm

Code	Quantity (pcs.)	Diameter (mm)	Box	Box
32020	9	2.5 - 10.0	x	50
32021	15	2.0 - 22.0	x	16

**7 BUILDERS LINE**

• ШНУР МАЛЯРНЫЙ • SCHLAGSchnUR



- Plastic housing • Quick string winding

Code	Length (m)	Box	Box
38003	30	x	10/100

**8 CHALK LINE REFILLS**

• КРАСКИ ДЛЯ МАЛЯРНОГО ШНУРА • SCHLAGSchnURKREIDE



- Plastic dispenser

Code	Volume (ml)	Colour	Box
42005	115	Blue	10/60
42006	115	Red	10/60
42007	225	Blue	10/60
42008	225	Red	10/60

**9 SUCTION LIFTER**

• ДЕРЖАТЕЛЬ-ПРИСОСКА ДЛЯ СТЕКЛА • SAUGNEBER



**Ø** 120mm **max** 80kg

Code	Holder diameter (mm)	Loading (kg)	Box	Box
32203	2 x 120	80	x	20

**10 SUCTION LIFTER**

• ДЕРЖАТЕЛЬ-ПРИСОСКА ДЛЯ СТЕКЛА • SAUGNEBER



**Ø** 120mm **max** 40kg

Code	Holder diameter (mm)	Loading (kg)	Box	Box
32202	120	40	x	12/48

**11 GLASS CUTTER**

• СТЕКЛОРЕЗ • UNIVERSAL GLASSSCHNEIDER



- 6 sintered carbide discs
- Wooden handle

**x6**

Code	Number of wheels	Box	Box
32206	6	x	12/480

**12 WINDOW SCRAPER**

• СКРЕБОК ДЛЯ СТЕКЛА • SCHEIBENKRATZER



**300mm** **100mm**

- Replaceable blade

Code	Length (mm)	Box	Box
31160	300	x	10/100

**13 SPARE BLADES FOR WINDOW SCRAPER**

• ЗАПАСНЫЕ ЛЕЗВИЯ ДЛЯ СКРЕБКА • ERSATZKLINGEN FÜR SCHEIBENKRATZER



**x10** **14x100mm**

- 10 blades in a box with a dispenser
- For 31160 scraper

Code	Blade (mm)	Box	Box
31163	100	x	20/200

**14 CENTERING POINTS**

• РАЗМЕТЧИКИ ДЛЯ НАГЕЛЬНЫХ СОЕДИНЕНИЙ • ÜBELHILFE



**x4** **Ø** 8mm **CENTRE**

- Made from high quality materials • Sharp cones for marking • Designed for mapping openings on the fixing surface

Code	Diameter (mm)	Box	Box
31392	8	x	50/100

**1 "MINI" PERMANENT MARKERS**

• МАРКЕРЫ НЕСТИРАЕМЫЕ "MINI" • „MINI“ PERMANENTMARKER



- Marker pens for writing on various surfaces such as metal, plastics, wood, and concrete
- Round tip with a small head for a narrow, clean, and permanent line
- Cap with a pendant
- Shelf life: 2 years from the date of manufacture
- Sold in an 80 pcs jar (38049 and 38043 is one piece)

Code	Colour	Quantity (pcs.)	Box
38049	black	80	160/960
38043	black, blue, red, green	80	160/960

**2 "BULLET" PERMANENT MARKERS**

• МАРКЕРЫ НЕСТИРАЕМЫЕ С КРУГЛЫМ КОНЦОМ • „BULLET“ PERMANENTMARKER



- Permanent markers designed for drawing on various surfaces, such as: metal, plastic, wood, concrete
- Round tip with a small head for a narrow, clean, and permanent line
- Shelf life: 2 years from the date of manufacture
- Sold in a 45 pcs jar (38039 and 38033 is one piece)

Code	Colour	Quantity (pcs.)	Box
38039	black	45	90/720
38033	black, blue, red, green	45	90/720

**3 "MINI" PERMANENT MARKERS**

• МАРКЕРЫ НЕСТИРАЕМЫЕ "MINI" • „MINI“ PERMANENTMARKER



- Marker pens for writing on various surfaces such as metal, plastics, wood, and concrete
- Round tip with a small head for a narrow, clean, and permanent line
- Cap with a pendant
- Shelf life: 2 years from the date of manufacture

Code	Colour	Quantity (pcs.)	Box
38041	black, blue, red, green	4	24/144

**4 "BULLET" PERMANENT MARKERS**

• МАРКЕРЫ НЕСТИРАЕМЫЕ С КРУГЛЫМ КОНЦОМ • „BULLET“ PERMANENTMARKER



- Marker pens for writing on various surfaces such as metal, plastics, wood, and concrete
- Round tip with a small head for a narrow, clean, and permanent line
- Cap with a pendant
- Shelf life: 2 years from the date of manufacture

Code	Colour	Quantity (pcs.)	Box
38031	black, blue, red	3	72/144

**5 "BULLET" PERMANENT MARKERS**

• МАРКЕРЫ НЕСТИРАЕМЫЕ С КРУГЛЫМ КОНЦОМ • „BULLET“ PERMANENTMARKER



- Marker pens for writing on various surfaces such as metal, plastics, wood, and concrete
- Round tip with a small head for a narrow, clean, and permanent line
- Shelf life: 2 years from the date of manufacture

Code	Colour	Quantity (pcs.)	Box
38032	black	2	24/192

**6 PENCILS**

• СТРОИТЕЛЬНЫЕ КАРАНДАШИ • BLEISTIFTE



240 mm

- Length 24 cm
- For various applications: woodworking - white, bricklaying - green, for glass - yellow, for wet surfaces - navy blue

Code	Type	Colour	Box
38020	bricklaying	Green	144/1008
38021	woodworking	White	144/1008
38022	for glass	Yellow	144/1008
38023	for wet surfaces	Navy Blue	144/1008

**7 PENCIL SHARPENER**

• ТОЧИЛКА ДЛЯ КАРАНДАШЕЙ • BLEISTIFTSPITZER



- Plastic body
- Blade can be sharpened

Code	Box	Box
38000	x	12/72

**8 CARPENTER'S PENCILS**

• КАРАНДАШИ ДЛЯ СТОЛЯРНЫХ РАБОТ • SCHREINERBLEISTIFTE



HB 245 mm

Code	Quantity (pcs.)	Box	Box
38202	2	x	24/480

**9 CARPENTER'S PENCILS**

• КАРАНДАШИ ДЛЯ СТОЛЯРНЫХ РАБОТ • SCHREINERBLEISTIFTE



HB 245 mm

Code	Quantity (pcs.)	Box	Box
38212	12	x	10/120

**10 CARPENTER'S PENCILS**

• КАРАНДАШИ ДЛЯ СТОЛЯРНЫХ РАБОТ • SCHREINERBLEISTIFTE



HB 245 mm

Code	Quantity (pcs.)	Box	Box
38244	144	x	10

**11 MASONRY PENCILS**

• КАРАНДАШИ ДЛЯ КАМНЯ • MAURERBLEISTIFTE



4H 245 mm

Code	Quantity (pcs.)	Box	Box
38102	2	x	24/480

**12 MASONRY PENCILS**

• КАРАНДАШИ ДЛЯ КАМНЯ • MAURERBLEISTIFTE



4H 245 mm

Code	Quantity (pcs.)	Box	Box
38112	12	x	10/120

**13 MASONRY PENCILS**

• КАРАНДАШИ ДЛЯ КАМНЯ • MAURERBLEISTIFTE



4H 245 mm

Code	Quantity (pcs.)	Box	Box
38144	144	x	10

**1 BOLT CUTTERS**

• БОЛТОРЕЗЫ • BOLZENSCHNEIDER



CrMo

Code	Size (mm)	Max cutting diameter (mm)	
17414	350	6	24
17418	450	7	2/8
17424	600	10	6
17430	750	12	4
17436	900	14	4
17442	1050	16	2

- Quenched • Jaws made from CrMo steel
- Jaw pressure adjustment • Ergonomic handles

**2 AVIATION SNIPS**

• РЫЧАЖНЫЕ НОЖНИЦЫ ПО МЕТАЛЛУ • BLECHSCHERE



CrMo

- For cutting standard metal sheet, up to 1.5 mm thick • Ergonomic handles from two-component material

Code	Size (mm)	Type		
17381	250	straight line	x	12/36
17382	250	right	x	12/36
17383	250	left	x	12/36

**3 OFFSET SNIPS**

• РЫЧАЖНЫЕ НОЖНИЦЫ ПО МЕТАЛЛУ  
• MASCHINENSCHRAUBSTOCK GEBOGEN



CrMo

- Offset jaw • For cutting standard metal sheet, up to 1.2 mm thick • Ergonomic handles

Code	Size (mm)	Type		
17370	240	right/straight line	x	12/36
17371	240	left/straight line	x	12/36

**4 AVIATION SNIPS**

• РЫЧАЖНЫЕ НОЖНИЦЫ ПО МЕТАЛЛУ • BLECHSCHERE



CrV

- For cutting standard metal sheet, up to 1.5 mm thick • Ergonomic handles

Code	Size (mm)	Type		
17375	250	right	x	12/48
17376	250	left	x	12/48
17377	250	straight line	x	12/48

**5 AVIATION SNIPS**

• НОЖНИЦЫ ПО МЕТАЛЛУ • DURCHLAUFBLECHSCHEREN



17384

17385

CrMo

Code	Size (mm)	Type		
17384	235	short straight line	x	6/48
17385	290	long straight line	x	6/36

**6 VERTICAL TIN SNIPS**

• НОЖНИЦЫ ПО МЕТАЛЛУ • ВЕРТИКАЛЕ BLECHSCHERE



17386

17387

CrMo

90°

Code	Size (mm)	Type		
17386	220	right	x	6/36
17387	220	left	x	6/36

**1 METAL-SHEET BENDING PLIERS**

• КЛЕЩИ ДЛЯ РЕЗКИ ЛИСТОВОГО МЕТАЛЛА • METALLBLECHBIEGEZANGE



• Jaw opening 60 mm

Code	Size (mm)	
17391	280	10 / 20
17392	280	10 / 20
17393	260	10 / 20

**2 CORNER VICE**

• ТИСКИ МАШИННЫЕ УГЛОВЫЕ • MASCHINENSCHRAUBSTOCK, WINKEL

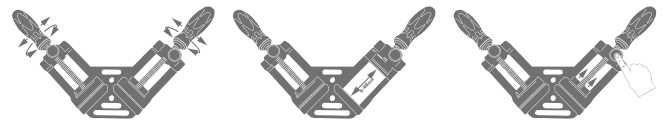

• Made from high quality aluminium alloy • Foldable, two-component handles increasing the torque • Buttons in the casing for quick clamp release • Trapezoid thread • Installation aid when bonding bevel joints 90°

Code	Size (mm)		
31383	68	x	12

**3 FIXED BENCH VICES**

• СЛЕСАРНЫЕ ТИСКИ НЕПОВОРОТНЫЕ • MASCHINENSCHRAUBSTOCK FEST



• With an anvil • Fixed base

Code	Jaw opening (mm)	Weight (kg)		
25507	75	4.0	x	4
25510	100	6.0	x	2
25512	125	8.5	x	2
25515	150	14.5	x	1

**4 SWIVEL BENCH VICES**

• СЛЕСАРНЫЕ ТИСКИ ПОВОРОТНЫЕ • MASCHINENSCHRAUBSTOCK DREHBAR



• With an anvil • Revolving base

Code	Jaw opening (mm)	Weight (kg)		
25610	100	6.5	x	2
25612	125	9.0	x	2
25615	150	16.5	x	1

PROLINE

LAHTI PRO

MEGA

JUCO

OTHER BRANDS

ERDI

KLINGSPOR

EXPRESS

ACTION CAN

TRYTON

VULCAN

### 1 FLAT ENGINEERING FILES

• НАПИЛЬНИКИ СЛЕСАРНЫЕ ПЛОСКИЕ • FLACHFEILEN



- High-quality tool steel • Cut no. 2
- Two-composite, non-slip TPR handle

Code	Size (mm)	Box	Case
32134	150	x	6/36
32135	200	x	6/36
32136	250	x	6/36

### 2 HALF ROUND ENGINEERING FILES

• НАПИЛЬНИКИ СЛЕСАРНЫЕ ПОЛУКРУГЛЫЕ • HALBRUNDFEILEN



- High-quality tool steel • Cut no. 2
- Two-composite, non-slip TPR handle

Code	Size (mm)	Box	Case
32234	150	x	6/36
32235	200	x	6/36
32236	250	x	6/36

### 3 THREE SQUARE ENGINEERING FILES

• НАПИЛЬНИКИ СЛЕСАРНЫЕ ТРЕУГОЛЬНЫЕ • DREIECKSFEILEN



- High-quality tool steel • Cut no. 2
- Two-composite, non-slip TPR handle

Code	Size (mm)	Box	Case
32244	150	x	6/36
32245	200	x	6/36
32246	250	x	6/36

### 4 ROUND ENGINEERING FILES

• НАПИЛЬНИКИ СЛЕСАРНЫЕ КРУГЛЫЕ • RUNDFEILEN



- High-quality tool steel • Cut no. 2
- Two-composite, non-slip TPR handle

Code	Size (mm)	Box	Case
32354	150	x	6/36
32355	200	x	6/36
32356	250	x	6/36

### 5 SQUARE ENGINEERING FILES

• НАПИЛЬНИКИ СЛЕСАРНЫЕ КВАДРАТНЫЕ • VIERKANTFEILEN



- High-quality tool steel • Cut no. 2
- Two-composite, non-slip TPR handle

Code	Size (mm)	Box	Case
32364	150	x	6/36
32365	200	x	6/36
32366	250	x	6/36

### 6 ENGINEERING FILE SET

• НАБОР СЛЕСАРНЫХ НАПИЛЬНИКОВ • FEILEN-SATZ



- High-quality tool steel • Cut no. 2
- Two-composite, non-slip TPR handle

Code	Quantity (pcs.)	Box	Case
32255	3	x	8

### 7 ENGINEERING FILE SET

• НАБОР СЛЕСАРНЫХ НАПИЛЬНИКОВ • FEILEN-SATZ



- High-quality tool steel • Cut no. 2
- Two-composite, non-slip TPR handle

Code	Quantity (pcs.)	Box	Case
32265	5	x	8

### 8 FLAT RASP

• РАШПИЛЬ ПЛОСКИЙ • HOLZRASPEL FLACH



- High-quality tool steel • Cut no. 2
- Two-composite, non-slip TPR handle

Code	Size (mm)	Box	Case
32932	200	x	6/36

### 9 HALF ROUND RASP

• РАШПИЛЬ ПОЛУКРУГЛЫЙ • HOLZRASPEL HALBRUND



- High-quality tool steel • Cut no. 2
- Two-composite, non-slip TPR handle

Code	Size (mm)	Box	Case
32922	200	x	6/36

### 10 HOLZRASPEL RUND

• РАШПИЛЬ КРУГЛЫЙ • HOLZRASPEL RUND



- High-quality tool steel • Cut no. 2
- Two-composite, non-slip TPR handle

Code	Size (mm)	Box	Case
32962	200	x	6/36

### 11 RASP SET

• НАБОР РАШПИЛЕЙ • HOLZRASPEL-SATZ



- High-quality tool steel • Cut no. 2
- Two-composite, non-slip TPR handle

Code	Quantity (pcs.)	Box	Case
32942	3	x	8



**1 DIAMOND FILE SET**

• НАБОР АЛМАЗНЫХ НАДФИЛЕЙ • DIAMANTFEILEN-SATZ



140 mm



• Plastic handle • In a case

Code	Quantity (pcs.)	Diameter (mm)		
32015	5	4	x	50/100

**2 WOOD CHISELS**

• СТАМЕЦКИ • HOLZMEISSEL



CrV HRC 60±2

• Steel reinforcement for slogging  
• Two-composite, non-slip TPR handle

Code	Blade width (mm)		
19106	6	x	6/24
19108	8	x	6/24
19110	10	x	6/24
19112	12	x	6/24
19114	14	x	6/24
19116	16	x	6/24
19118	18	x	6/24
19120	20	x	6/24
19122	22	x	6/24
19125	25	x	6/24
19132	32	x	6/24
19138	38	x	6/24

**3 WOOD CHISEL SET**

• НАБОР СТАМЕЦОВ • HOLZMEISSEL-SATZ



CrV HRC 60±2

• Steel reinforcement for slogging  
• Two-composite, non-slip TPR handle

Code	Width (mm)		
19142	6, 12, 20, 25	x	8

**4 SCRAPER**

• РУБАНОК-СКРЕБОК • ABSTREIFER



140x40 mm

Code	Length (mm)		
31601	140	x	6 / 60

**5 SCRAPER**

• РУБАНОК-СКРЕБОК • ABSTREIFER



250x40 mm

Code	Length (mm)		
31602	250	x	6 / 60

**6 SCRAPER**

• РУБАНОК-СКРЕБОК • ABSTREIFER



AL 140x40 mm

Code	Length (mm)		
31611	140	x	10/60

**7 SCRAPER**

• РУБАНОК-СКРЕБОК • ABSTREIFER



AL 250x40 mm

• The handle may be blocked in two positions

Code	Length (mm)		
31612	250	x	10/40

**8 BLADE FOR SCRAPER**

• ЛЕЗВИЕ ДЛЯ РУБАНКА-СКРЕБКА • MESSER FÜR ABSTREIFER



140x40 mm

• Universal dimension fits Proline 31601, 31611 and other scrapers on the market

Code	Weight (g)		
31621	140	x	10/200

**9 BLADE FOR SCRAPER**

• ЛЕЗВИЕ ДЛЯ РУБАНКА-СКРЕБКА • MESSER FÜR ABSTREIFER



250x40 mm

• Universal dimension fits Proline 31602, 31612 and other scrapers on the market

Code	Length (mm)		
31622	250	x	10/200

PROLINE

LANIT PRO

MEGA

JUCO

OTHER BRANDS

ERDI

KLINGSPOR

EXPRESS

ACTION CAN

TRAYTON

VULCAN

**1 STEEL WIRE BRUSHES**

• ШЁТКИ МЕТАЛЛИЧЕСКИЕ • STAHLDRANTBÜRSTEN



32613 with scraper



32614



32615

STEEL

• Steel wire bristles

Code	Number of rows	Length (mm)		
32613	3 x 19	340	x	6/36
32614	4 x 16	260	x	6/36
32615	5 x 11	180	x	12/72

**2 STAINLESS STEEL WIRE BRUSHES**

• ШЁТКИ МЕТАЛЛИЧЕСКИЕ • EDELSTAHLDRANTBÜRSTEN



32623 with scraper



32624



32625

STAINLESS STEEL

• Stainless steel bristles

Code	Number of rows	Length (mm)		
32623	3 x 19	340	x	6/36
32624	4 x 16	260	x	6/36
32625	5 x 11	180	x	12/72

**3 BRASS WIRE BRUSHES**

• ШЁТКИ МЕТАЛЛИЧЕСКИЕ • MESSINGDRANTBÜRSTEN



32633 with scraper



32634



32635

BRASS

• Brass wire bristles

Code	Number of rows	Length (mm)		
32633	3 x 19	340	x	6/36
32634	4 x 16	260	x	6/36
32635	5 x 11	180	x	12/72

**4 NYLON WIRE BRUSHES**

• ШЁТКИ МЕТАЛЛИЧЕСКИЕ • NYLON-DRANTBÜRSTEN



32643 with scraper



32644



32645

NYLON

• Brass wire bristles

Code	Number of rows	Length (mm)		
32643	3 x 19	340	x	6/36
32644	4 x 16	260	x	6/36
32645	5 x 11	180	x	12/72

**5 WIRE BRUSH SET**

• НАБОР ЩЁТОК МЕТАЛЛИЧЕСКИХ • DRANTBÜRSTEN-SET



x3

STAINLESS STEEL

BRASS

NYLON

• Stainless steel, brass and nylon bristles

Code	Number of rows	Length (mm)		
32603	3 x 7	180	x	12/72

**1 HSS HAND TAPS**

• МЕТЧИКИ ИЗ СТАЛИ HSS • HANDGEWINDEBOHRER HSS



**DIN 352 HSS**

- DIN 352 HSS SW7M, professional quality
- Delivered in sets of 2, no. 1, 2
- Metric standard and fine thread
- Supplied in a plastic box

Code	Thread	
67043	M3	50
67044	M4	80
67045	M5	80
67046	M6	50
67048	M8	25
67049	M8 X 1	25
67050	M10	25
67051	M10 X 1	25
67052	M12	25

**2 HSS HAND TAPS**

• МЕТЧИКИ ИЗ СТАЛИ HSS • HANDGEWINDEBOHRER HSS



**DIN 352 HSS**

- DIN 352 HSS SW7M, professional quality
- Delivered in sets of 3, no. 1, 2, 3
- Metric standard thread
- Supplied in a plastic box

Code	Thread	
67023	M3	40
67024	M4	50
67025	M5	50
67026	M6	40
67028	M8	25
67030	M10	15
67032	M12	25

**3 HSS DIES**

• ПЛАШКИ ИЗ СТАЛИ HSS • SCHNEIDEISEN HSS



**DIN EN 352 HSS**

- DIN EN 22568 HSS SW7M, professional quality
- Metric standard and fine thread
- Supplied in a round plastic box

Code	Thread	Diameter (mm)	
67123	M3	25	150
67124	M4	25	150
67125	M5	25	150
67126	M6	25	150
67128	M8	25	150
67129	M8 x 1	25	150
67130	M10	25	150
67131	M10 x 1	25	150
67132	M12	25	150

**4 21 PC. TAP SET**

• НАБОР МЕТЧИКОВ 21 ШТ. • 21-TLG. SET GEWINDEBOHRER



**x21 HSS**

- M3, M4, M5, M6, M8, M10, M12
- Each size x3

Code	Quantity (pcs.)	
67221	21	20

**5 32 PC. TAP AND DIE SET**

• НАБОР МЕТЧИКОВ И ПЛАШЕК 32 ШТ. • 32-TLG. SET GEWINDEBOHRER UND SCHNEIDEISEN



**x32 HSS**

- M3, M4, M5, M6, M8, M10, M12
- Taps, each size x 3 pcs
- Tap wrench, die, screwdriver

Code	Quantity (pcs.)	
67232	32	10

**6 TAP WRENCHES**

• ВОРОТКИ ДЛЯ МЕТЧИКОВ • KNEBELGRIFF FÜR GEWINDEBOHRER



- Supplied in a plastic case with a suspension

Code	Typ	For taps	L (mm)	
67095	NR 0	M1 - M4	125	50
67096	NR 1	M3 - M11	205	50
67097	NR 1.5	M3 - M12	205	40
67098	NR 2	M4,5 - M16	305	40
67099	NR 4	M11 - M27	395	25

**7 DIE HOLDER**

• ВОРОТОК ДЛЯ ПЛАШЕК • SCHNEIDEISENHALTER



- For notches with external dia. 25 mm
- Supplied in a plastic case with a suspension

Code	For notches	
67198	M7 - M9	65

PROLINE

LAHTI PRO

MEGA

JUCO

OTHER BRANDS

ERDI

KLINGSPOR

EXPRESS

ACTION CAN

TRYTON

VULCAN

**1 SEMI-LIQUID GREASE**

• МАШИННАЯ СМАЗКА • MASCHINENFETT



- For greasing rolling bearings, slide bearings, joints and guides • Works with heavy load
- Resistant to cold water washing • Offers protection from corrosion • Plastic syringe-type dispenser

Code	Volume (ml)	
42231	70	12

**3 LUBRICATING OIL**

• МАШИННОЕ МАСЛО • MASCHINENÖL



- For lubricating low-load parts of industrial machines - bearings, guides, mechanical gears, spindles and auxiliary friction nodes, as well as locks, hinges, household appliances
- Plastic syringe-type dispenser

Code	Volume (ml)	
42234	70	12

**2 MACHINERY VASELINE**

• ТЕХНИЧЕСКИЙ ВАЗЕЛИН • TECHNISCHE VASELINE



- Designed for lubricating low-load friction nodes, greasing rubber and leather gaskets, protecting metal parts from corrosion, and as an agent protecting from rubber gasket adhesion and freezing • Plastic syringe-type dispenser

Code	Volume (ml)	
42233	70	12

**4 GRAPHITE GREASE**

• ГРАФИТОВАЯ СМАЗКА • GRAPHITFETT



- For lubricating slow-rotating mechanisms and heavily-loaded friction surfaces, drive chains, worm gears, screw threads and as an assembly grease • Resistant to cold water washing • Plastic syringe-type dispenser

Code	Volume (ml)	
42232	70	12

**5 COMPRESSED AIR**

• СЖАТЫЙ ВОЗДУХ • SUSĖGĒTAS ORAS



- For blowing: office equipment, small household appliances and similar; whenever we wish to remove dust, volatile dirt and waste, especially in places difficult to reach • Substance: mixture of n-Butane and Propane (%w/w: 40-60) • Class: F+, R12

Code	Volume (ml)	
42304	400	4/24

**6 SHACKLE PADLOCKS**

• ЗАМКИ НАБЕЧНЫЕ • BÜGELSCHLÖSSER



- Material: nickel-reinforced cast iron resistant to damage • Quenched bow
- Double locking • 4 keys with unique code
- Lock cylinder made from brass • Resistant to lock drilling

Code	Length (mm)		
24840	40	x	12/96
24850	50	x	12/96
24860	60	x	12/72

**7 CLOSE SHACKLE TYPE PADLOCKS**

• ЗАМКИ НАБЕЧНЫЕ • BOLZENSCHLÖSSER



- Material: nickel-reinforced cast iron resistant to damage • Quenched bow
- Double locking • 4 keys with unique code

Code	Length (mm)		
24261	60	x	6/72
24271	70	x	6/72
24281	80	x	6/48
24291	90	x	6/48

**8 SHACKLE TYPE PADLOCKS**

• ЗАМКИ НАБЕЧНЫЕ • BÜGELSCHLÖSSER



- Material: nickel-reinforced cast iron resistant to damage • Quenched bow
- Double locking • 4 keys with unique code • Lock cylinder made from brass
- Resistant to lock drilling

Code	Length (mm)		
24940	40	x	12/96
24950	50	x	12/96
24960	60	x	12/72

## JOINING TOOLS



- burners**
- cable ties**
- electrodes**
- glue guns**
- glues**
- riveters**
- rivets**
- staple guns**
- staples**
- welders**
- and many others**

**1 MULTI-FUNCTION ALUMINUM STAPLE GUN**

• УНИВЕРСАЛЬНЫЙ АЛЮМИНИЕВЫЙ РУЧНОЙ СКОБОЗАБИВАТЕЛЬ • MULTIFUNKTIONALE ALUMINIUM-HEFTPISTOLE



**6in1 AL NO SWITCH PATENT**

Staples	Staples PROLINE	L (mm)
---------	-----------------	--------

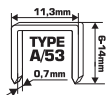

55306	6
55308	8
55310	10
55312	12
55314	14

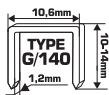

55410	10
55412	12
55414	14

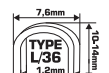

55440	10
55442	12

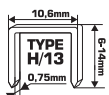

-	-
---	---



-	-
---	---



-	-
---	---

• Patented NO SWITCH mechanism (just insert Nails or Staples in the magazine and the stapler is immediately ready for operation, without having to change the mode of operation with a switch) • Up to 6 different types of 6-15 mm nails or staples can be used • Adjustment of punching force for staples • Fast loading of staples from the bottom of the stapler • Lightweight aluminum housing • Includes a set of staples (500 pcs.)

Code	Height (mm)		
55037	6 - 15	x	6/24

**2 MULTI-FUNCTION METAL STAPLE GUN**

• УНИВЕРСАЛЬНЫЙ МЕТАЛЛИЧЕСКИЙ РУЧНОЙ СКОБОЗАБИВАТЕЛЬ • MULTIFUNKTIONALE METALL-HEFTPISTOLE



**3in1**

Staples	Staples PROLINE	L (mm)
---------	-----------------	--------

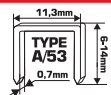

55306	6
55308	8
55310	10
55312	12

• Metal housing • Equipped with a mechanism enabling three modes of operation

Code	Height (mm)		
55038	6 - 12	x	8/32

**3 MULTI-FUNCTION STAPLE GUN / TACKER**

• УНИВЕРСАЛЬНЫЙ РУЧНОЙ СКОБОЗАБИВАТЕЛЬ • MULTIFUNKTIONALE HEFTPISTOLE/TACKER



Staples	Staples PROLINE	L (mm)
---------	-----------------	--------

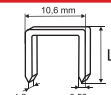

55406	6
55408	8
55410	10
55412	12
55414	14

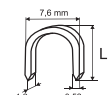

55440	10
55442	12

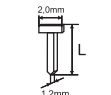

55340	10
55342	12
55344	14

• Adjustable staple puncture force

Code	Height (mm)		
55036	6 - 14	x	12/24

**4 STAPLE GUN / TACKER**

• РУЧНОЙ МЕТАЛЛИЧЕСКИЙ СКОБОЗАБИВАТЕЛЬ • HEFTPISTOLE/TACKER



Staples 53	Staples PROLINE	Staples MEGA	L (mm)
------------	-----------------	--------------	--------

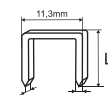

55306	55206	6
55308	55208	8
55310	55210	10
55312	55212	12
55314	55214	14

• Adjustable staple puncture force

Code	Height (mm)		
55024	4 - 14	x	20/40

**5 STAPLE GUN / TACKER**

• РУЧНОЙ СКОБОЗАБИВАТЕЛЬ • HEFTPISTOLE/TACKER



Staples 53	Staples PROLINE	Staples MEGA	L (mm)
------------	-----------------	--------------	--------

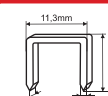

55306	55206	6
55308	55208	8

Code	Height (mm)		
55028	4 - 8	x	20/40

**1 MULTI-FUNCTION STAPLE GUN / TACKER**

• УНИВЕРСАЛЬНЫЙ РУЧНОЙ СКОБОЗАБИВАТЕЛЬ  
• MULTIFUNKTIONALE HEFTPISTOLE/TACKER



Staples G, S, E	Staples PROLINE	L (mm)
	55406	6
	55408	8
	55410	10
	55412	12
	55414	14
	55330	10
	55332	12
	55340	10
	55342	12
	55344	14

• Adjustable staple puncture force • Delivered with rectangular staples 10 mm - 100 pcs., semi-circular staples 12 mm - 100 pcs., nails 10 mm - 100 pcs.

Code	Height (mm)	Box	Box
55034	6 - 14	x	12/24

**2 HAMMER TACKER**

• РУЧНОЙ УДАРНЫЙ СКОБОЗАБИВАТЕЛЬ • HAMMER-TACKER



Staples G	Staples PROLINE	L (mm)
	55406	6
	55408	8
	55410	10

Code	Height (mm)	Box	Box
55040	6 - 10	x	10/20

**3 STAPLE GUN**

• РУЧНОЙ ЩИПЦОВЫЙ СКОБОЗАБИВАТЕЛЬ • HEFTPISTOLE



Staples R	Staples PROLINE	L (mm)
	55426	6
	55428	8

Code	Height (mm)	Box	Box
55042	6 - 8	x	10/40

**4 ELECTRIC STAPLER**

• СТЕПЛЕР ЭЛЕКТРИЧЕСКИЙ • ELEKTRISCHE HEFTMASCHINE



230 V 50 Hz 800W 3 m

2in1 30 pcs/min. TOUGH STRIKE SECURITY SYSTEM Max 120 PCS POWER REGULATOR

SAFETY SWITCH TYPE A/53 5-14mm 11.2mm 1.2mm 0.52mm TYPE D/53F

15.5mm 1.2mm 0.52mm TYPE E/J 15-16mm 11.2mm 0.52mm

CE

• Adjustable driving force • Protection against unintended discharge • Safety switch  
• Construction allowing work in corners  
• Matching Staples in Proline's offer 55306-55314

Code	Power (W)	Box	Box
55050	800	x	6

**5 PNEUMATIC STAPLER**

• СТЕПЛЕР ПНЕВМАТИЧЕСКИЙ • DRUCKLUFT-HEFTER



max 8 BAR TOUGH STRIKE SECURITY SYSTEM Max 100 PCS 1/4"

TYPE 80 11.2mm 1.2mm 0.52mm CE

• Protection against unintended discharge  
• Adjustable air direction setting • Delivered in a plastic box • Designed for upholstery work • Matching Staples in Proline's offer 55506-55516

Code	Max air pressure (bar)	Box
66391	8	10

**6 PNEUMATIC STAPLER / NAILER**

• СТЕПЛЕР ПНЕВМАТИЧЕСКИЙ • DRUCKLUFT-HEFTER/-NAGLER



max 8 BAR 2in1

TOUGH STRIKE SECURITY SYSTEM Max 120 PCS 1/4" TYPE 90 15-16mm

5.7mm 1.2mm 0.52mm TYPE F 15-16mm 11.2mm 0.52mm CE

• Protection against unintended discharge  
• Adjustable air direction setting • Delivered in a plastic box • Designed for joinery work  
• Matching Staples in Proline's offer 55506-55516 • Matching Staples in Proline's offer 55715 - 55750

Code	Max air pressure (bar)	Box
66392	8	10

PROLINE

LAHTI PRO

MEGA

JUCO

OTHER BRANDS

ERDI

KLINGSPOR

EXPRESS

ACTION CAN

TRYTON

VULCAN

**1 HARDENED STAPLES - TYPE A/53**

• ЗАКАЛЕННЫЕ СКОБЫ ТИПА А/53 • GEHÄRTETE KLAMMERN - TYP A/53



Staples A/53

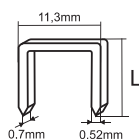

x1000



• Staple equivalents: - ARROW®JT-21 - STANLEY#A/53 - ESCO#530 - KWB#053 - NOVUS#53 - RAPID#53 - ROCAFIX#3

Code	Height (mm)		
55306	6	x	100/200
55308	8	x	100/200
55310	10	x	100/200
55312	12	x	100/200
55314	14	x	100/200

**3 HARDENED STAPLES - TYPE R/50**

• ЗАКАЛЕННЫЕ СКОБЫ ТИПА R/50 • GEHÄRTETE KLAMMERN - TYP R/50



Staples R/50

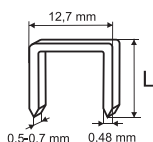

x1000

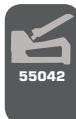

• Staple equivalents: - KWB#052 - NOVUS#50 - RAPID#140 - ROCAFIX#6 - ESCO#970

Code	Height (mm)		
55426	6	x	100/200
55428	8	x	100/200

**4 HARDENED STAPLES - TYPE S**

• ЗАКАЛЕННЫЕ СКОБЫ ПОЛУКРУГЛЫЕ ТИПА S • GEHÄRTETE KLAMMERN - TYP S



Staples S

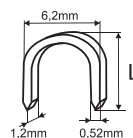

x1000



• Staple equivalents: - NOVUS#S - RAPID#28 - ROCAFIX#8

Code	Height (mm)		
55330	10	x	100/200
55332	12	x	100/200

**2 HARDENED STAPLES - TYPE G/11**

• ЗАКАЛЕННЫЕ СКОБЫ ТИПА G/11 • GEHÄRTETE KLAMMERN - TYP G/11



Staples G/11

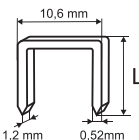

x1000



• Staple equivalents: - ARROW®T-50K - STANLEY G/11 - KWB#057 - NOVUS#11 - RAPID#140 - ROCAFIX#4

Code	Height (mm)		
55406	6	x	100
55408	8	x	100
55410	10	x	100
55412	12	x	100
55414	14	x	100





**1 HARDENED STAPLES - TYPE L**

- ЗАКАЛЕННЫЕ СКОБЫ ПОЛУКРУГЛЫЕ ТИПА L
- GEHÄRTETE KLAMMERN - TYP L



Staples L

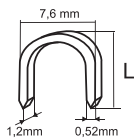

x1000



- Staple equivalents: - NOVUS#L - RAPID#36 - ROCAFIX#7

Code	Height (mm)		
55440	10	x	100/200
55442	12	x	100/200

**2 HARDENED STAPLE NAILS - TYPE E/J**

- ШТИФТЫ ТИПА E/J - GEHÄRTETE KLAMMERNÄGEL - TYP E/J



Nails E/J

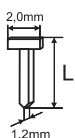

x1000



- Nail equivalents: - ESCO#300 - NOVUS#E - ROCAFIX#No8

Code	Height (mm)		
55340	10	x	100/200
55342	12	x	100/200
55344	14	x	100/200

**3 HARDENED STAPLES - TYPE 80**

- ЗАКАЛЕННЫЕ СКОБЫ ТИПА 80 - GEHÄRTETE KLAMMERN - TYP 80

Staples 80

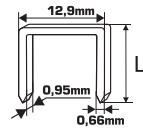

x1000



- Dedicated for pneumatic staplers

Code	Height (mm)		
55506	6	x	200
55508	8	x	200
55510	10	x	100
55512	12	x	100
55514	14	x	100
55516	16	x	100

**4 HARDENED STAPLES - TYPE 90**

- ЗАКАЛЕННЫЕ СКОБЫ ТИПА 90 - GEHÄRTETE KLAMMERN - TYP 90

Staples 90

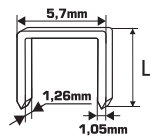

x1000



- Dedicated for pneumatic staplers

Code	Height (mm)		
55616	16	x	72
55619	19	x	72
55622	22	x	60
55625	25	x	48
55628	28	x	48
55632	32	x	36
55638	38	x	36
55640	40	x	36

**5 HARDENED STAPLE NAILS - TYPE F**

- ШТИФТЫ ТИПА F - GEHÄRTETE KLAMMERNÄGEL - TYP F

Nails F

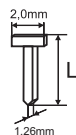

x1000



- Dedicated for pneumatic staplers

Code	Height (mm)		
55715	15	x	150
55720	20	x	120
55725	25	x	100
55730	30	x	80
55735	35	x	70
55740	40	x	60
55745	45	x	60
55750	50	x	50

**1 RIVETER**

• ЗАКЛЕПОЧНИК  
• NIET

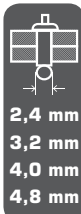

• For blind rivets made from aluminium and steel • Quenched head parts extend riveter lifecycle

Code		
14007	x	12/24

**2 SWIVEL HEAD RIVETER**

• ЗАКЛЕПОЧНИК С ВРАЩАЮЩЕЙСЯ ГОЛОВКОЙ • SCHWENKORF-NIETZANGE

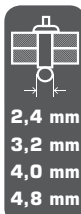

• Revolving head facilitating work in places difficult to reach • For copper and iron rivets dia. 2.4 mm and 3.2 mm and for aluminium rivets dia. 2.4 mm, 3.2 mm, 4.0 mm and 4.8 mm • Quenched head parts extend riveter lifecycle

Code		
14010	x	6/24

**3 LONG ARM RIVETER**

• ЗАКЛЕПОЧНИК РЫЧАЖНЫЙ • LANGARMNIETZANGE



• For rivets made from steel, stainless steel, copper and aluminium

Code	Length (mm)	
14008	540	10

**4 LAZY TONG RIVETER**

• РЫЧАЖНО-СКЛАДНОЙ ЗАКЛЕПОЧНИК (ГАРМОШКА) • ZANGENNIETER



• For aluminium rivets

Code	Length (mm)	
14006	840	12

**5 NUT RIVET RIVETER KIT**

• ЗАКЛЕПОЧНИК ОДНРУЧНЫЙ ДЛЯ ЗАКЛЕПОК-ГАЕК • MUTTER-NIET-NIETMASCHINE KIT



• Four adapter sets for every size of rivet nut, a wrench and basic set of 10 rivet nuts of every size • For compressing threaded bushings in thin walls while fastening them

Code	For rivet nuts	Quantity of rivet nuts (pcs.)	
14011	M3, M4, M5, M6	40	10

**6 NUT RIVET RIVETER KIT**

• ЗАКЛЕПОЧНИК ДВУРУЧНЫЙ ДЛЯ ЗАКЛЕПОК-ГАЕК • MUTTER-NIET-NIETMASCHINE KIT



• Seven adapter sets for every size of rivet nut, a wrench, and basic set of 10 rivet nuts of every size • For compressing threaded bushings in thin walls while fastening them

Code	For rivet nuts	
14012	M3, M4, M5, M6, M8, M10, M12	5

**7 NUT RIVETS**

• ЗАКЛЕПКИ-ГАЙКИ СТАЛЬНЫЕ • MUTTERNNIETEN

• Material: steel • Supplied in a plastic bag of 20 items



Code	Type	Quantity (pcs.)	Max thickness of joined materials (mm)	Length (mm)	Rivet nut Ø (mm)	Drill Ø (mm)	
59711	M3	20	2.0	9	4.9	5.0	100/400
59712	M4	20	2.0	11	5.9	6.0	100/400
59713	M5	20	2.5	13	6.9	7.0	60/240
59714	M6	20	3.0	15	8.8	9.0	36/144
59715	M8	20	3.5	18	10.8	11.0	25/100
59716	M10	20	3.5	21	12.8	13.0	16/64
59717	M12	20	3.5	22	14.8	15.0	12/48

**1 BRAZING BURNER**

• ГАЗОВАЯ ПРОПАНОВАЯ ГОРЕЛКА • LÖTBRENNER

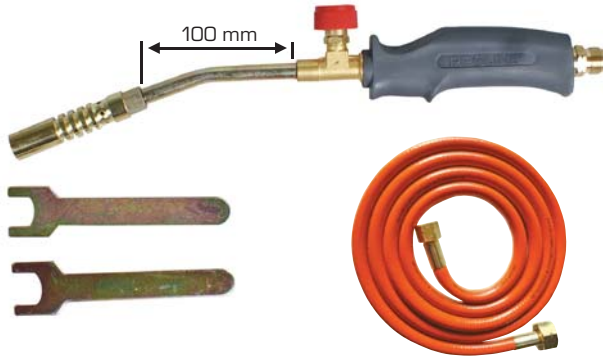

17 mm, 1850°C, 4,5 kW, 0,32 kg/h LPG, 2m, x2



- LPG-supplied
- Pin-point flame (propane butane)
- Hose meets the requirements of EN ISO 9012 and EN 16436-1

Code	
<b>60040</b>	6/18

**2 BRAZING BURNER**

• ГАЗОВАЯ ПРОПАНОВАЯ ГОРЕЛКА • LÖTBRENNER

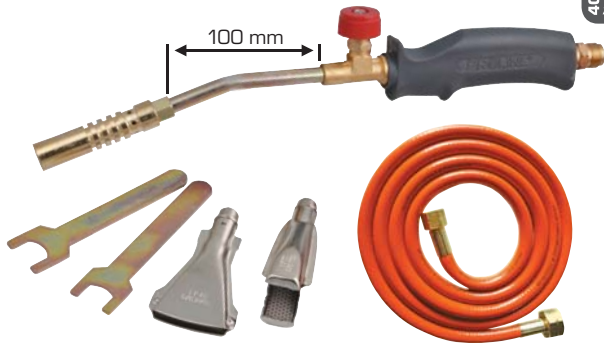

40 mm, 32 mm, 17 mm, 1850°C, 4,5 kW, 0,32 kg/h LPG, 2m, x2



- LPG-supplied (propane butane)
- With three nozzles with flame:
  - pin-point
  - surrounding
  - flat
- Hose meets the requirements of EN ISO 9012 and EN 16436-1

Code	
<b>60041</b>	6/12

**3 BURNER**

• ГАЗОВАЯ ПРОПАНОВАЯ ГОРЕЛКА • BRENNER

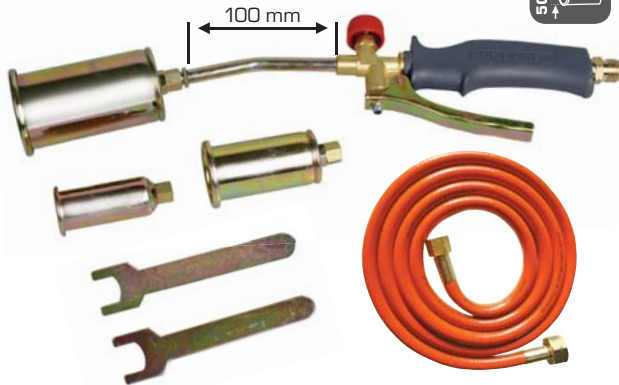

50 mm, 35 mm, 35 mm, 1850°C, 50 kW, 3,57 kg/h LPG, 2m, x2



- LPG-supplied (propane butane)
- With three nozzles with distributed flame
- Hose meets the requirements of EN ISO 9012 and EN 16436-1

Code	
<b>60042</b>	8

**4 TORCH**

• СОПЛО ДЛЯ ГАЗОВОЙ ПРОПАНОВОЙ ГОРЕЛКИ • HANDBRENNER



- Surrounding flame

Code	For burners	
	60040	50
<b>60045</b>	60041	50
	60042	50

**5 TORCH**

• СОПЛО ДЛЯ ГАЗОВОЙ ПРОПАНОВОЙ ГОРЕЛКИ • HANDBRENNER



- Flat flame

Code	For burners	
	60040	50
<b>60046</b>	60041	50
	60042	50

**6 TORCH**

• СОПЛО ДЛЯ ГАЗОВОЙ ПРОПАНОВОЙ ГОРЕЛКИ • HANDBRENNER



- Distributed flame

Code	For burners	
	60042	50
<b>60047</b>	60042	50

**7 TORCH**

• СОПЛО ДЛЯ ГАЗОВОЙ ПРОПАНОВОЙ ГОРЕЛКИ • HANDBRENNER



- Pin-point flame

Code	For burners	
	60040	50
<b>60048</b>	60041	50

PROLINE

LAHTI PRO

MEGA

JUCO

OTHER BRANDS

ERDI

KLINGSPOR

EXPRESS

ACTION CAN

TRAYTON

VULCAN

**1 BURNER**

• ГАЗОВАЯ ПРОПАНОВАЯ ГОРЕЛКА - BRENNER

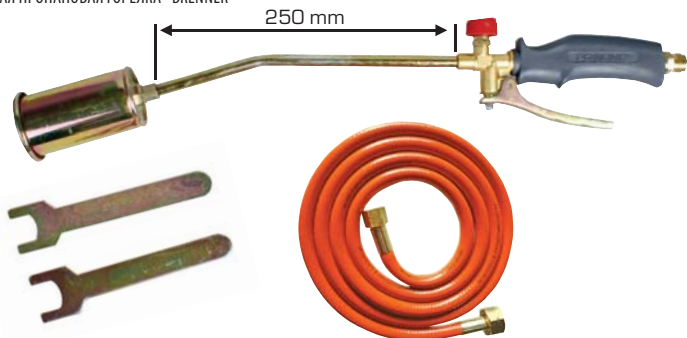

50 mm	1400°C	28 kW	2 kg/h LPG	2m	x2
-------	--------	-------	------------	----	----



- LPG-supplied (propane butane)
- Distributed flame
- Hose meets the requirements of EN 16436-1

Code	
<b>60050</b>	6/12

**2 OOF WORK BURNER**

• ГАЗОВАЯ ПРОПАНОВАЯ ГОРЕЛКА - OOF ARBEITSBRENNER



60 mm	1850°C	42,5 kW	3,12 kg/h LPG	5m	x2
-------	--------	---------	---------------	----	----



- LPG-supplied (propane butane)
- Distributed flame
- Hose meets the requirements of EN ISO 9012 and EN 16436-1

Code	
<b>60051</b>	8

**3 DOUBLE TORCH ROOF WORK BURNER**

• ГАЗОВАЯ ПРОПАНОВАЯ ГОРЕЛКА С ДВОЙНЫМ СОПЛОМ - DOPPELBRENNER FÜR DACHARBEITEN



60 mm x2	1850°C	85 kW	6,24 kg/h LPG	5m	x2
----------	--------	-------	---------------	----	----



- LPG-supplied (propane butane)
- With a support (see the photo)
- With 2 nozzles with distributed flame
- Hose meets the requirements of EN ISO 9012 and EN 16436-1

Code	
<b>60052</b>	8

**4 TRIPLE TORCH ROOF WORK BURNER**

• ГАЗОВАЯ ПРОПАНОВАЯ ГОРЕЛКА С ТРОЙНЫМ СОПЛОМ - DREIFACH-BRENNER FÜR DACHARBEITEN



50 mm x3	1850°C	99 kW	6,90 kg/h LPG	5m	x2
----------	--------	-------	---------------	----	----



- LPG-supplied (propane butane)
- With a support (see the photo)
- With 3 nozzles with distributed flame
- Hose meets the requirements of EN ISO 9012 and EN 16436-1

Code	
<b>60053</b>	6

**1 SOLDERING WIRE**

• ОЛОВО ПАЯЛЬНОЕ · LÖTDRANT



S-  
Sn60  
Pb40  
2,5%



- Sn60 Pb40 soldering wire 2.5%
- Perfect for accurate soldering of small components
- For DIY works and professionals

Code	Length (m)	Diameter (mm)	Box	Carton
60324	3 x 3	1	x	200

**2 SOLDERING WIRE**

• ОЛОВО ПАЯЛЬНОЕ · LÖTDRANT



S-  
Sn60  
Pb40  
2,5%



- Sn60 Pb40 soldering wire 2.5%
- Perfect for accurate soldering of small components
- For DIY works and professionals

Code	Length (m)	Diameter (mm)	Box
60332	3	1	100

**3 SOLDERING WIRE**

• ОЛОВО ПАЯЛЬНОЕ · LÖTDRANT



S-  
Sn60  
Pb40  
2,5%



- Sn60 Pb40 soldering wire 2.5%
- Perfect for accurate soldering of small components
- For DIY works and professionals

Code	Weight (g)	Diameter (mm)	Box	Carton
60320	100	0.56	x	100
60321	100	0.7	x	100
60322	100	1	x	100
60323	100	1.5	x	100
60325	100	0.56	-	60
60326	100	0.7	-	60
60327	100	1	-	60
60328	100	1.5	-	60
60329	100	2	-	60
60330	100	2.5	-	60
60331	100	3	-	60

**4 MICROTORCH**

• МИНИГОРЕЛКА · MIKROBRENNER



1300°C

28ml  
PROPAN-  
BUTAN

60-70  
min.

- Easy loading of lighter gas

Code	Volume (ml)	Box	Carton
60034	28	x	10/20

**5 7 PC. GAS TORCH SET**

• НАБОР 7 ШТ. С МИНИГОРЕЛКОЙ - ПАЯЛЬНИКОМ  
• 7 STK. GASBRENNER-SET



1300°C

13ml  
PROPAN-  
BUTAN

60min.

- Easy loading of lighter gas
- The set includes: burner, soldering tips - 3 pcs (soldering tip temperature 200 - 450 °C), blade tip - temperature 3500C, soldering head, solder, tip cleaning container

Code	Volume (ml)	Box
60037	13	20



PROLINE  
LANITI PRO  
MEGA  
JUCO  
OTHER BRANDS  
ERDI  
KLINGSPOR  
EXPRESS  
ACTION GUN  
TRAYTON  
VULCAN

**1 GLUE GUN**  
• ТЕРМОКЛЕЕВОЙ ПИСТОЛЕТ • КЛЕБЕРИСТОЛЕ



110-240 V 230 V 50 Hz 50 Hz Ø 11,2mm 12 W (72 W) CE

Code	Glue Ø [mm]		
42911	11.2	x	12/24

**2 GLUE GUN**  
• ТЕРМОКЛЕЕВОЙ ПИСТОЛЕТ • КЛЕБЕРИСТОЛЕ



110-240 V 50 Hz Ø 11,2mm 25 W (78 W) CE

Code	Glue Ø [mm]		
42912	11.2	x	12/24

**3 GLUE GUN**  
• ТЕРМОКЛЕЕВОЙ ПИСТОЛЕТ • КЛЕБЕРИСТОЛЕ



230 V 50 Hz Ø 11,2mm 20 W (200 W) CE

Code	Glue Ø [mm]		
42916	11.2	x	12/24

**4 CORDLESS GLUE GUN**  
• ТЕРМОКЛЕЕВОЙ ПИСТОЛЕТ • КАБЕЛЛОСЕ КЛЕБЕРИСТОЛЕ



230 V 50 Hz Ø 11,2mm 35 W (400 W) CE

Code	Glue Ø [mm]		
42917	11.2	x	12

**5 GLUE GUN WITH ON/OFF SWITCH**

• ТЕРМОКЛЕЕВОЙ ПИСТОЛЕТ С ВЫКЛЮЧАТЕЛЕМ  
• КЛЕБЕРИСТОЛЕ MIT EIN-/AUSSCHALTER



230 V 50 Hz Ø 11,2mm 28 W (180 W) CE

• The switch enables to switch the gun off without unplugging

Code	Glue Ø [mm]		
42915	11.2	x	6/12

**6 GLUE BARS**  
• КЛЕЕВЫЕ СТЕРЖНИ • КЛЕБСТОФФСТÄБЕ



• For glue guns • Transparent • Hot-melt  
• Designation: general use, when binding plastic, fabrics, metal, cables, etc.

Code	Ø [mm]	L [mm]	Quantity [pcs.]	Weight [kg]	
42901	11.2	200	50	1	20

**7 GLUE BARS**  
• КЛЕЕВЫЕ СТЕРЖНИ • КЛЕБСТОФФСТÄБЕ



42903



42918

• For glue guns • Transparent • Hot-melt  
• Designation: general use, when binding plastic, fabrics, metal, cables

Code	Ø [mm]	L [mm]	Quantity [pcs.]		
42902	11.2	200	12	x	25/50
42903	11.2	100	6	x	50/200
42905	11.2	250	12	x	25/50
42904	8	100	12	x	50/200
42918	8	50	12	x	50/200

## INVERTER WELDER TECHNOLOGY

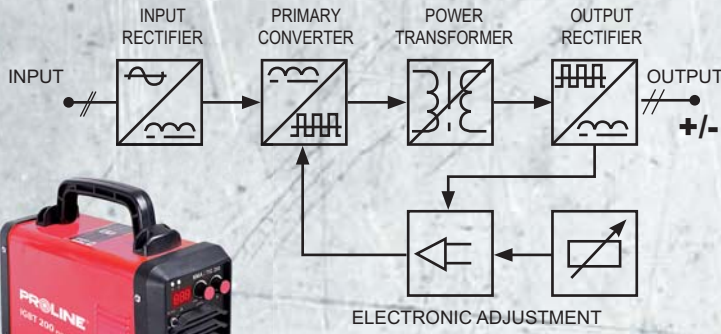

## TRANSFORMER VS INVERTER WELDER

	INVERTER WELDER	TRANSFORMER WELDER
dimension and weight	*****	**
current stability	*****	**
energy consumption	*****	**
type of electrodes used	*****	*
welding quality control	*****	*
general parameters	*****	**

\* = positive assessment

## MMA PROCESS

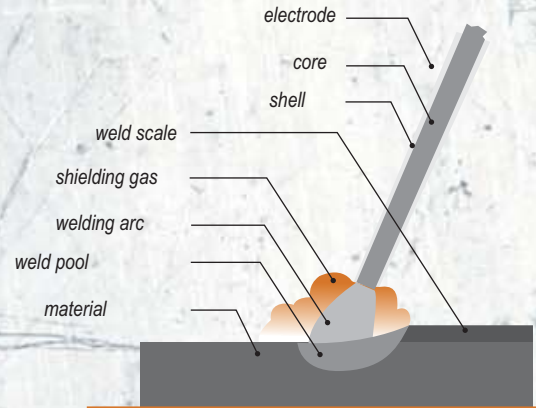

## MMA PROPERTIES

+ ADVANTAGES	- DISADVANTAGES
• highly practical	• limited performance
• significant savings	• scale removal
• no gas cylinders	
• welding in all positions	

## EFFICIENCY

Efficiency is the number of minutes in a 10 minute period during which the welder can operate continuously. The device's efficiency stated in the catalogue is measured at 40°C

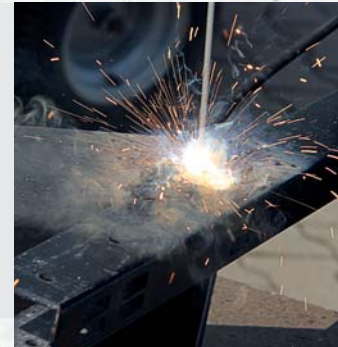
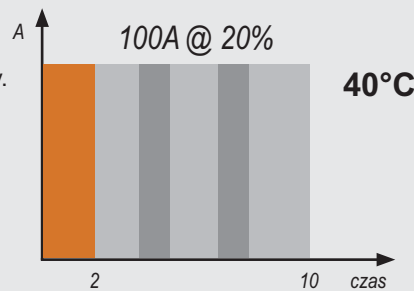

## ADDITIONAL FUNCTIONS

### ■ ARC FORCE

The function shortens the arc while the welding current increases. This makes it easier to ignite the arc when starting welding and to maintain it. This optimises the transfer of drops from the electrode onto the workpiece, preventing the arc from going out when the electrode comes into contact with the workpiece. It is available only in inverter welders.

### ■ HOT START

The function increases the welding current when the arc is ignited in order to warm up the material and the electrode. The function optimises process parameters. It is available in inverter and transformer welders.

### ■ ANTI-STICK

The function limits the welding current by preventing the electrode from sticking to the material being welded during arc ignition and heating up when it sticks. A useful function for inexperienced welders. It is available only in inverter welders.

## AVERAGE WELDING CURRENT (A)

TYPE OF ELECTRODE	ELECTRODE DIAMETER						
	1,6	2	2,5	3,25	4	5	6
RUTILE	30-55	40-70	50-100	80-130	120-70	150-250	220-370
BASIC	50-75	60-100	70-120	110-150	140-200	190-260	250-320
CELLULOSE	20-45	30-60	40-80	70-120	100-150	140-230	200-300

## WELDERS VS ELECTRODE TYPE

BASIC ELECTRODE	RUTILE ELECTRODE	CELLULOSE ELECTRODE	ELECTRODE FOR STAINLESS STEEL
optimum material purity	easy ignition	Designed for MMA welding of pipes and tanks (deep and „sticky“ weld lake) where tightness for gas, water and all types of liquids under pressure is required.	Designed for MMA welding of stainless steel
welding in all positions	stable arc		
high mechanical quality of welding	good aesthetics and smooth welding		
	low costs		
	easy storage		
DC INVERTER	DC INVERTER AC TRANSFORMATOR		

## ИНВЕРТОРНЫЙ СВАРОЧНЫЙ АППАРАТ



## ТРАНСФОРМАТОР VS ИНВЕРТОРНЫЙ СВАРОЧНЫЙ АППАРАТ

	ИНВЕРТОРНЫЙ СВАРОЧНЫЙ АППАРАТ	ТРАНСФОРМАТОРНЫЙ СВАРОЧНЫЙ АППАРАТ
размеры и вес	*****	**
стабильность тока	*****	**
энергопотребление	*****	**
тип используемых электродов	*****	*
контроль качества сварки	*****	*
общие параметры	*****	**

\* = положительная оценка

## ММА ПРОЦЕСС



## ММА СВОЙСТВА

+	ПРЕИМУЩЕСТВА	-	НЕДОСТАТКИ
	• высокая практичность		• ограниченная производительность
	• значительная экономия		• удаление окалины
	• нет газовых баллонов		
	• сварка во всех положениях		

## ЭФФЕКТИВНОСТЬ

Эффективность - это количество минут в 10-минутном периоде, в течение которого сварщик может работать непрерывно. Заявленная в каталоге эффективность устройства измеряется при 40 °С.

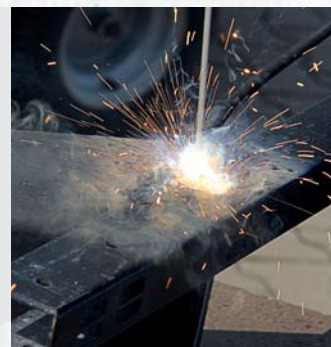
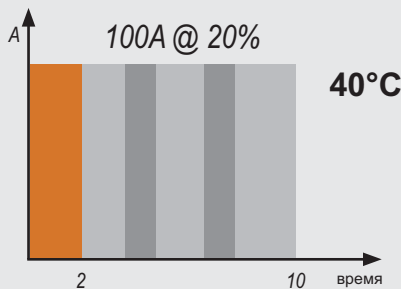

## ДОПОЛНИТЕЛЬНЫЕ ФУНКЦИИ

### ■ ФОРСИРОВАНИЕ ДУГИ

Функция укорачивает дугу, а сварочный ток увеличивается. Это облегчает зажигание дуги в начале сварки и ее поддержание. Оптимизирует перенос капель с электрода на деталь, исключая выход дуги при контакте электрода с деталью. Доступно только для инверторных сварочных аппаратов.

### ■ ГОРЯЧИЙ ЗАПУСК

Функция повышает сварочный ток при зажигании дуги, чтобы нагреть материал и электрод. Функция оптимизирует параметры процесса. Доступно для инверторных и трансформаторных сварочных аппаратов.

### ■ ANTI-ПРИЛИПАНИЕ

Эта функция ограничивает сварочный ток, исключая прилипание электрода к свариваемому материалу при зажигании дуги и нагрев при прилипании. Полезная функция для неопытных сварщиков. Доступно только для инверторных сварочных аппаратов.

## СРЕДНИЙ СВАРОЧНЫЙ ТОК (A)

ТИП ЭЛЕКТРОДА	ДИАМЕТР ЭЛЕКТРОДА						
	1,6	2	2,5	3,25	4	5	6
РУТИЛОВЫЙ	30-55	40-70	50-100	80-130	120-70	150-250	220-370
БАЗОВЫЙ	50-75	60-100	70-120	110-150	140-200	190-260	250-320
ЦЕЛЛЮЛОЗНЫЙ	20-45	30-60	40-80	70-120	100-150	140-230	200-300

## СВАРОЧНЫЕ АППАРАТЫ ПО ТИПУ ЭЛЕКТРОДА

БАЗОВЫЙ ЭЛЕКТРОД	РУТИЛОВЫЙ ЭЛЕКТРОД	ЦЕЛЛЮЛОЗНЫЙ ЭЛЕКТРОД	ЭЛЕКТРОД ДЛЯ НЕРЖАВЕЮЩЕЙ СТАЛИ
оптимальная чистота материала	легкое зажигание	Предназначен для ММА сварки труб и резервуаров (глубокий и «липкий» сварной шов), где требуется герметичность для газа, воды и всех типов жидкостей под давлением.	Предназначен для ММА сварки нержавеющей стали
сварка во всех положениях	стабильная дуга		
высокое механическое качество сварки	хорошая эстетичность и плавная сварка		
	небольшие расходы		
	простое хранение		
ПРЕОБРАЗОВАТЕЛЬ ПОСТОЯННОГО ТОКА	ПРЕОБРАЗОВАТЕЛЬ ПОСТОЯННОГО ТОКА	ТРАНСФОРМАТОР ПЕРЕМЕННОГО ТОКА	



## TECHNOLOGIE DES INVERTER-SCHWEISSGERÄTS

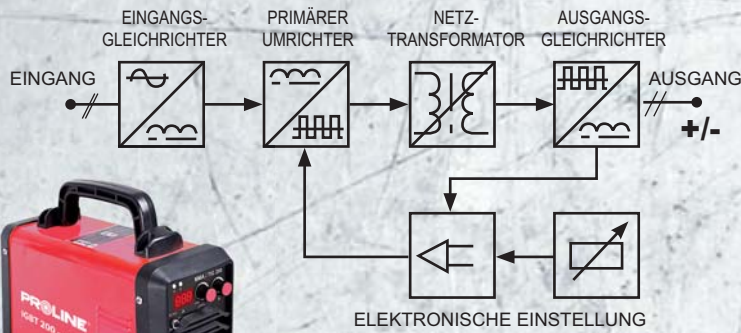

## TRAFO- VS. INVERTER-SCHWEISSGERÄT

	INVERTER-SCHWEISSGERÄT	TRAFO-SCHWEISSGERÄT
Größe und Gewicht	*****	**
Stromstabilität	*****	**
Energieverbrauch	*****	**
Art der verwendeten Elektroden	*****	*
Schweißqualitätskontrolle	*****	*
Allgemeine Parameter	*****	**

\* = positive Bewertung

## EFFIZIENZ

Durch die Effizienz wird die Anzahl der Minuten in einem Zeitraum von 10 Minuten bezeichnet, in denen der Schweißer kontinuierlich arbeiten kann. Die im Katalog angegebene Effizienz des Geräts wird bei 40°C gemessen.

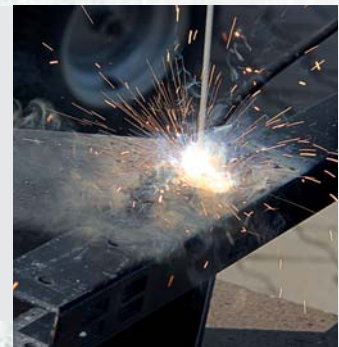
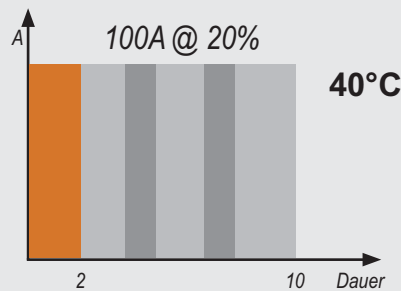

## ZUSÄTZLICHE FUNKTIONEN

### ■ BOGENSTÄRKE

Durch diese Funktion wird der Bogen verkürzt, während der Schweißstrom erhöht wird. Dies erleichtert das Zünden des Bogens beim Beginn des Schweißens und dessen Aufrechterhaltung. Hierdurch wird der Transfer von Tropfen von der Elektrode auf das Werkstück optimiert, wodurch verhindert wird, dass der Bogen erlischt, wenn es zum Kontakt zwischen der Elektrode und dem Werkstück kommt. Die Funktion ist nur für Inverter-Schweißgeräte verfügbar.

### ■ HOT START

Durch die Funktion wird der Schweißstrom erhöht, wenn der Bogen gezündet wird, wobei dies die Erwärmung des Materials und der Elektrode zum Zweck hat. Die Funktion optimiert die Prozessparameter. Sie ist in Inverter- und Trafo-Schweißgeräten verfügbar.

### ■ ANTI-STICK

Die Funktion begrenzt den Schweißstrom, indem verhindert wird, dass die Elektrode während der Bogenzündung an dem zu schweißenden Material kleben bleibt und sich während des Festklebens erwärmt. Eine nützliche Funktion für unerfahrene Schweißer. Die Funktion ist nur für Inverter-Schweißgeräte verfügbar.

## MMA-PROZESS

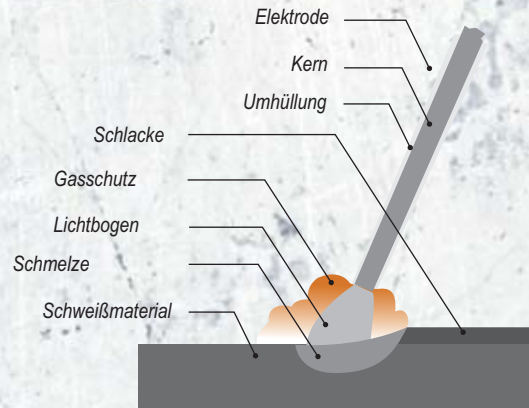

## EIGENSCHAFTEN DES MMA-SCHWEISSENS

+ VORTEILE	- NACHTEILE
• sehr praktisch	• eingeschränkte Leistung
• erhebliche Einsparungen	• Entfernung der Schlacke
• keine Gaszylinder	
• Schweißen in allen Positionen	

## DURCHSCHNITTLICHER SCHWEISSSTROM (A)

TYP DER ELEKTRODE	ELEKTRODE DURCHMESSER						
	1,6	2	2,5	3,25	4	5	6
RUTIL	30-55	40-70	50-100	80-130	120-70	150-250	220-370
BASIC	50-75	60-100	70-120	110-150	140-200	190-260	250-320
CELLULOSE	20-45	30-60	40-80	70-120	100-150	140-230	200-300

## SCHWEISSGERÄTE VS. ELEKTRODENARTEN

STANDARDELEKTRODE	RUTILELEKTRODE	CELLULOSEELEKTRODE	ELEKTRODE FÜR EDELSTAHL
Optimale Materialreinheit	Einfache Zündung	Entwickelt für das MMA-Schweißen von Rohren und Tanks (tiefe und „klebrige“ Schmelze), wo es erforderlich ist, dass eine Dichtigkeit für Gas, Wasser und alle anderen Arten von Flüssigkeiten unter Druck vorhanden ist.	Entwickelt für das MMA-Schweißen von Edelstahl
Schweißen in allen Positionen	Stabiler Lichtbogen		
Hohe mechanische Qualität des Schweißens	Gute Ästhetik und glatte Schweißnähte		
	Niedrige Kosten		
	Einfache Lagerung		
DC-WANDLER	DC-WANDLER AC-TRANSFORMATOR		

**1 MMA INVERTER WELDERS**

• ИНВЕРТОРНЫЙ СВАРОЧНЫЙ АППАРАТ MMA • MMA WECHSELRICHTER SCHWEISSGERÄTE



230 V  
50 Hz

MMA



- Inverter welding machines MMA200, MMA160 Technology IGTB • Functions: "Hot start", "Anti stick", "Arc force" • Unloaded nominal voltage of -82 V
- Work cycle -30% • Efficiency -85% • Fan cooled • Recommended electrode diameter 1.6-4 mm • Insulation class - H • Level of security 21S • Thermal protection • Equipment: 1.8 m cable with a 200A electrode holder and 1.2 m cable with a 200 A ground clamp • Weight: 5,1kg

Code	Output current range [A]	Rated output power [kVA]	
42940	20 - 150	5,7	1
42941	20 - 170	6,6	1

**2 MMA / TIG INVERTER WELDER**

• ИНВЕРТОРНЫЙ СВАРОЧНЫЙ АППАРАТ MMA / TIG • MMA / TIG WECHSELRICHTER SCHWEISSGERÄT



230 V  
50 Hz



- Inverter welding machine MMA/TIG 200 • Technology IGTB • Funktion: "TIG PULSE" • Unloaded nominal voltage of -60 V • Work cycle -60% @200A • Efficiency -85% • Cooling with a fan • Recommended electrode diameter: TIG nonconsumable electrode - 1.6-4 mm, MMA electrode - 1.6-4 mm
- Insulation class - H • Level of security 21S • Thermal protection
- Equipment: Electricity and gas TIG cable, 3 m, TIG ceramic nozzles, 3 pcs (5,6,7), TIG sleeve clamp, 3 pcs. (1.6 mm, 2 mm, 2.4 mm), nonconsumable TIG electrode, 1 pc (1.6X150 mm) • 1.8 m MMA cable with a 200 A electrode holder; 1.2 m MMA cable with a 200 A ground clamp • Weight: 7,1 kg

Code	Output current range [A]	Rated output power [kVA]	
42942	20 - 170	8	1

**3 C TYPE WELDING LOCKING PLIERS**

• КЛЕЩИ СВАРОЧНЫЕ, ТИП С • SCHWEISSVERRIEGELUNGSZANGE TYP C



CrV

HRC  
42 ± 2



- Adjustable force and clamp clearance • Nickel plated • Movable anvil

Code	Length [mm]	Max. width [mm]	
28252	280	86	6/24

**5 U TYPE WELDING LOCKING PLIERS**

• КЛЕЩИ СВАРОЧНЫЕ, ТИП U • SCHWEISSVERRIEGELUNGSZANGE TYP U



CrV

HRC  
42 ± 2



- Adjustable force and clamp clearance • Nickel plated

Code	Length [mm]	Max. width [mm]	
28251	225	41	6/24

**4 C TYPE WELDING LOCKING PLIERS**

• КЛЕЩИ СВАРОЧНЫЕ, ТИП С • SCHWEISSVERRIEGELUNGSZANGE TYP C



CrV

HRC  
42 ± 2



- Adjustable force and clamp clearance • Nickel plated • Non movable anvil

Code	Length [mm]	Max. width [mm]	
28253	280	86	6/24

**6 WELDING LOCKING PLIERS**

• КЛЕЩИ СВАРОЧНЫЕ ПЛОСКИЕ • SCHWEISSVERRIEGELUNGSZANGE



CrV

HRC  
42 ± 2



- Adjustable clamping force and jaw distance • Nickel plated

Code	Length [mm]	Max. width [mm]	
28250	200	13	6/24

### 1 RUTILE-CELLULOSE ELECTRODES

• ЭЛЕКТРОДЫ РУТИЛО - ЦЕЛЛЮЛОЗНЫЕ • RUTIL-CELLULOSE ELEKTRODEN



Certificate of Compliance with the CPR Regulation of the European Parliament and of the Council (EU) No. 305/2011. Issued by the Building Research Institute (Instytut Techniki Budowlanej)

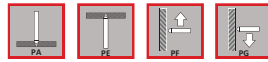

- Coated rutile and cellulosic electrode for welding low-carbon steel
- PROLINE electrodes are not sensitive to the quality of edge preparation, presence of corrosion, varnish or other impurities on the welded surface
- The electrodes are packed in double plastic film protection to prevent their humidification • Emission of hazardous substances during welded 28% lower • Tensile strength at least 450 N/mm<sup>2</sup>

Code	Diameter (mm)	Packaging weight (kg)	☐
66511	2.0	0.50	40
66514	3.2	0.50	40
66517	2.5	1.00	20
66519	3.2	1.00	20
66522	2.5	2.50	1
66524	3.2	2.50	1
66525	4.0	2.50	1

### 2 ELECTRODE HOLDERS

• ДЕРЖАТЕЛИ ЭЛЕКТРОДОВ • ELEKTRODENHALTER



Code	Max current (A)	Diameter (mm)	☐
66900	160	1.6 - 4.0	25
66901	200	2.5 - 5.0	25
66902	315	2.5 - 6.3	25
66903	400	3.5 - 6.3	25

### 3 WELDING CLAMPS

• ЗАЖИМ ПОЛЮСНЫЙ ВИНТОВОЙ • SCHWEISSKLEMMEN



Code	Max current (A)	Cable (mm <sup>2</sup> )	☐
66910	150	25 - 35	25
66911	300	50 - 70	25
66912	400	70 - 95	25

### 4 WELDING CLAMPS

• ЗАЖИМ КЛЕЩЕВОЙ ПОЛЮСНЫЙ • SCHWEISSKLEMMEN



Code	Max current (A)	Cable (mm <sup>2</sup> )	☐
66920	160	25 - 35	25
66921	315	50 - 70	25
66922	520	70 - 95	25



### 5 WELDING WIRE

• ОМЕДНЕННАЯ СВАРОЧНАЯ ПРОВОЛОКА • SCHWEISSDRAHT



- Wire G G3Si1 (SG2) • Plastic spool
- 66047 - metal spool

Code	Diameter (mm)	Packaging weight (kg)	☐
66040	0.6	1	18
66041	0.8	1	18
66042	1.0	1	18
66043	1.2	1	1
66045	0.8	5	1
66046	0.8	15	1
66047	1.0	15	1
66048	1.2	15	1

### 6 NYLON CABLE TIES

• ЗАЖИМНЫЕ ХОМУТЫ НЕЙЛОНОВЫЕ • NYLON-KABELBINDER



- Made from high quality nylon • Resistant to UV rays • Smooth, rounded tie edges, protecting cables from abrasion • Available white and black • Single-use only • Useful temperatures from -20°C to +50°C • Narrowed ending section facilitating tie clamping

Code	Length (mm)	Width (mm)	☐	☐
WHITE				
59110B	100	2.5	x	250/500
59120B	200	2.5	x	125/250
59130B	300	3.6	x	65/130
59121B	200	4.8	x	75/150
59131B	300	4.8	x	50/100
59140B	400	4.8	x	40/80
BLACK				
59110C	100	2.5	x	250/500
59120C	200	2.5	x	125/250
59130C	300	3.6	x	65/130
59121C	200	4.8	x	75/150
59131C	300	4.8	x	50/100
59140C	400	4.8	x	40/80

## TOOL STORAGE

- backpacks
- organizers
- pouches
- tool bags
- tool belts
- tool boxes
- tool pockets



**1 TOOL BOXES WITH ALUMINIUM LOCKS**

• ЯЩИКИ ДЛЯ ИНСТРУМЕНТОВ С АЛЮМИНИЕВЫМИ ЗАМКАМИ • WERKZEUGKÄSTEN MIT ALUMINIUM-SCHLÖSSERN



- Made of high quality materials • Cover with two built organizers • Robust and ergonomic handle • Internal tray holder • Strong closing • Dedicated for the workshop and home use • Suitable for storage of small and bigger elements • Metal pins in hinges (22" and 25") • **35716 with one buckle**

Code	Dimension (mm)	Dimension (cale)	
35716	398 x 200 x 186	16"	1
35718	458 x 257 x 227	18"	1
35722	550 x 267 x 270	22"	1
35725	597 x 285 x 320	25"	1

**2 TOOL BOXES**

• ЯЩИКИ ДЛЯ ИНСТРУМЕНТОВ • WERKZEUGKASTEN



- Made of high quality materials • Cover with two built organizers • Robust and ergonomic handle • Internal tray holder • Strong closing • Dedicated for the workshop and home use • Suitable for storage of small and bigger elements • Model 35737 with a single buckle

Code	Dimension (mm)	Dimension (cale)	
35737	398 x 200 x 186	16"	1
35738	458 x 257 x 227	18"	1
35739	550 x 267 x 270	22"	1
35740	597 x 285 x 320	25"	1

**3 TOOL BOX WITH ALUMINIUM FRAME**

• ЯЩИК ДЛЯ ИНСТРУМЕНТОВ С АЛЮМИНИЕВОЙ РУЧКОЙ • WERKZEUGKASTEN MIT ALUMINIUMRAHMEN

PROLINE HD®



- Made from high quality polypropylene • Aluminium frame ensuring comfortable grip • Cover with two integrated organisers • Increased volume

Code	Dimension (mm)	Dimension (cale)	
35748	458 x 257 x 245	18"	1

**4 TOOL BOX WITH ALUMINIUM FRAME**

• ЯЩИК ДЛЯ ИНСТРУМЕНТОВ С АЛЮМИНИЕВОЙ РУЧКОЙ • WERKZEUGKASTEN MIT ALUMINIUMRAHMEN

PROLINE HD®



- Made from high quality polypropylene • Aluminium frame ensuring comfortable grip • Cover with two integrated organisers • Increased volume • Metal pins in hinges

Code	Dimension (mm)	Dimension (cale)	
35752	550 x 267 x 277	22"	1

**5 TOOL BOX WITH ALUMINIUM FRAME**

• ЯЩИК ДЛЯ ИНСТРУМЕНТОВ С АЛЮМИНИЕВОЙ РУЧКОЙ • WERKZEUGKASTEN MIT ALUMINIUMRAHMEN

PROLINE HD®



- Made from high quality polypropylene • Aluminium frame ensuring comfortable grip • Cover with two integrated organisers • Increased volume • Metal pins in hinges

Code	Dimension (mm)	Dimension (cale)	
35755	598 x 286 x 327	25"	1



PROLINE

LANITI PRO

MEGA

JUCO

OTHER BRANDS

ERDI

KUNGSFOR

EXPRESS

ACTION CAN

TRYTON

VULCAN

**1 METAL TOOL BOXES**

• ИНСТРУМЕНТАЛЬНЫЙ МЕТАЛЛИЧЕСКИЙ ЯЩИК, 2 РУЧКИ  
• METALLWERKZEUGKÄSTEN

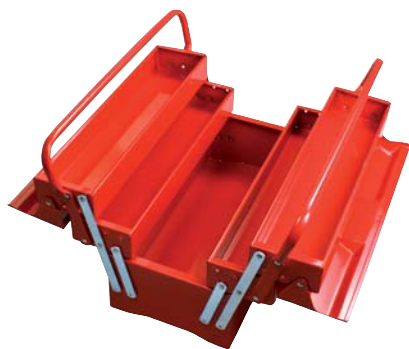

Code	Dimension (mm)	Number of parts	
33403	404 x 200 x 240	3	1
33405	404 x 200 x 290	5	1

**2 METAL TOOL BOXES**

• ИНСТРУМЕНТАЛЬНЫЙ МЕТАЛЛИЧЕСКИЙ ЯЩИК, ОДНА РУЧКА  
• METALLWERKZEUGKÄSTEN



Code	Dimension (mm)	Number of parts	
33553	550 x 200 x 157	3	1
33555	550 x 200 x 208	5	1

**3 ORGANISERS**

• ОРГАНИЗАТОРЫ • ORGANIZER



• Made from high quality materials • Inner compartments arranging the organiser interior • Strong locks • Perfect in the workshop and at home • Good for petty and larger objects

Code	Dimension (mm)	Number of compartments	
35700	35 x 90 x 180	6	120
35701	35 x 160 x 200	5	60

**4 ORGANISERS**

• ОРГАНИЗАТОРЫ • ORGANIZER



• Made from high quality materials • Inner compartments arranging the organiser interior • Strong locks • Perfect in the workshop and at home • Good for petty and larger objects • Handle for carrying and transport

Code	Dimension (mm)	Number of compartments	
35726	245 x 150 x 85	5	38
35727	295 x 195 x 85	5	24
35728	359 x 238 x 85	6	18
35729	400 x 298 x 85	6	12

**5 ORGANISERS**

• ОРГАНИЗАТОРЫ • ORGANIZER

**PROLINE HD®**



**PP**

• Made from high quality materials • System of compartments to arrange the organiser interior • Cover with appropriate shape, combined with interior compartments, prevents object dislocation • Strong locks • Perfect in the workshop and at home • Good for petty and larger objects • Handle for carrying and transport

Code	Dimension (mm)	Number of compartments	
35702	35 x 155 x 195	11	48
35703	35 x 195 x 290	21	60
35704	65 x 290 x 390	15	10
35710	65 x 390 x 490	18	6

**6 ORGANISER**

• ОРГАНИЗАТОР • ORGANIZER

**PROLINE HD®**



**PP**

• Made from high quality materials • System of removable, colourful compartments to arrange the organiser interior • Strong locks • Perfect in the workshop and at home • Good for petty and larger objects • Handle for carrying and transport • Hooks on the back side for mounting on walls

Code	Dimension (mm)	Number of compartments	
35744	50 x 303 x 390	21	1

**7 ORGANISER**

• ОРГАНИЗАТОР • ORGANIZER

**PROLINE HD®**



**PP**

• Made from high quality materials • System of compartments to arrange the organiser interior • Cover with appropriate shape, combined with interior compartments, prevents object dislocation • Strong locks • Perfect in the workshop and at home • Good for petty and larger objects • Handle for carrying and transport

Code	Dimension (mm)	Number of compartments	
35706	130 x 290 x 390	30	5

**8 ORGANISERS**

• ОРГАНИЗАТОРЫ С РУЧКОЙ  
• ORGANIZER

**PROLINE HD®**



**PP**

• Made from high quality materials • Strong locks • Perfect in the workshop and at home • Good for petty and larger objects • Handle for carrying and transport • Hooks on the back side for mounting on walls

Code	Dimension (mm)	Number of drawers	
35741	260 x 200 x 400	6	1
35743	392 x 200 x 400	9	1

**1 OPEN TOOL BAG**

• СУМКА ДЛЯ ИНСТРУМЕНТА, ОТКРЫТАЯ • OFFENE WERKZEUGTASCHE



- 30 pockets (5 inside, 13 outside, 12 pockets for drills and bits)
- Reinforced and stiffened
- Steel handle with soft rubber
- Soft, comfortable, adjustable shoulder strap

x30 600 D POLYESTER HEAVY DUTY

Please note: the bag is sold without tools

Code	Dimension (mm)	
62149	500 x 230 x 280	4

**2 TROLLEY BAG WITH PULL-OUT HANDLE**

• СУМКА ДЛЯ С РУЧКОЙ, НА КОЛЕСАХ • TROLLEYTASCHE MIT AUSZIEHBAREM GRIFF



- 28 pockets (11 inside, 17 outside) • 2 wheels
- Retractable handle • Soft, comfortable, adjustable shoulder strap • Soft, comfortable handle
- Bag with a zip fastener

x28 600 D POLYESTER HEAVY DUTY

Code	Dimension (mm)	
62151	510 x 290 x 360	6

**3 TOOL BAG**

• СУМКА ДЛЯ ИНСТРУМЕНТА • WERKZEUGTASCHE



- 25 pockets (15 inside, 10 outside)
- Soft, comfortable, adjustable shoulder strap
- The soft, comfortable handle
- Bag with a zip fastener

x25 600 D POLYESTER HEAVY DUTY

Code	Dimension (mm)	
62161	610 x 270 x 400	6

**4 TOOL BAG**

• СУМКА ДЛЯ ИНСТРУМЕНТА • WERKZEUGTASCHE



- 49 pockets (10 inside, 39 outside)
- Soft, comfortable, adjustable shoulder strap
- Soft, comfortable handle
- Bag with a zip fastener

x49 600 D POLYESTER HEAVY DUTY

Code	Dimension (mm)	
62150	500 x 270 x 340	6

**5 RUBBER BASE TOOL BAG**

• СУМКА ДЛЯ ИНСТРУМЕНТА С РЕЗИНОВЫМ ДНОМ • WERKZEUGTASCHE MIT GUMMIBASIS



- 20 pockets (11 inside, 9 outside) plus 8 elastic strips plus one handle
  - Waterproof rubber bag base, resistant to any mechanical damage, even in low temperatures
  - Soft, comfortable, adjustable shoulder strap
  - Soft, comfortable handle
  - Bag with a zip fastener
- Please note: the bag is sold without tools

x20 600 D POLYESTER HEAVY DUTY RUBBER

Code	Dimension (mm)	
62138	380 x 260 x 320	12

**6 TOOL BAG**

• СУМКА ДЛЯ ИНСТРУМЕНТА • WERKZEUGTASCHE



- 16 pockets (6 inside, 10 outside)
- Soft, comfortable, adjustable shoulder strap
- Soft, comfortable handle
- Bag with a zip fastener

x16 600 D POLYESTER HEAVY DUTY

Code	Dimension (mm)	
62141	410 x 230 x 300	12

**7 TOOL BAG**

• СУМКА ДЛЯ ИНСТРУМЕНТА • WERKZEUGTASCHE



- 30 pockets (13 inside, 17 outside) plus spirit level holder
- Soft, comfortable, adjustable shoulder strap
- Soft, comfortable handle
- Bag with a zip fastener

x30 600 D POLYESTER HEAVY DUTY

Code	Dimension (mm)	
62146	460 x 280 x 300	12

PROLINE

LAHTI PRO

MEGA

JUCO

OTHER BRANDS

ERDI

KLINGSPOR

EXPRESS

ACTION CAN

TRAYTON

VULCAN

**1 TOOL BACKPACK**

• МОНТЕРСКИЙ РЮКЗАК ДЛЯ ИНСТРУМЕНТА  
• WERKZEUGRUCKSACK



**x29** **600 D POLYESTER** **HEAVY DUTY**

- 29 pockets (20 inside, 9 outside)
  - Soft, comfortable, adjustable shoulder straps
  - 1 snap hook
  - Comfortable rubber handle
  - The backpack has 2 separate compartments, each with a zip fastener
- Please note: the backpack is sold without tools

Code	Dimensions (mm)	
62100	330 x 160 x 430	12

**2 SLEEVELESS WORK JACKET**

• МОНТЕРСКИЙ ЖИЛЕТ ДЛЯ ИНСТРУМЕНТА • ÄRMELLOSE ARBEITSJACKE



**x8** **600 D POLYESTER** **HEAVY DUTY**

- 8 pockets, 7 elastic belts for precision screwdrivers, 1 hammer holder, 1 snap hook
  - Fully adjustable to any size
- Please note: the jacket is sold without tools

Code	Dimensions (mm)	
52070	510 x 600	12

**3 FOLDING CHAIR**

• СКЛАДНОЙ СТУЛ • KLAPPSTUHL



**600 D POLYESTER**

**HEAVY DUTY**

**max 90kg**

- Steel structure
- Wide scope of application, e.g. workshop works, fishing, mushroom picking, gardening, tourism

Code	Load (kg)	
62142	90	12

**4 TOOL POUCH WITH BELT**

• КАРМАН С ПОЯСОМ ДЛЯ ИНСТРУМЕНТА • WERKZEUGTASCHE MIT GÜRTEL

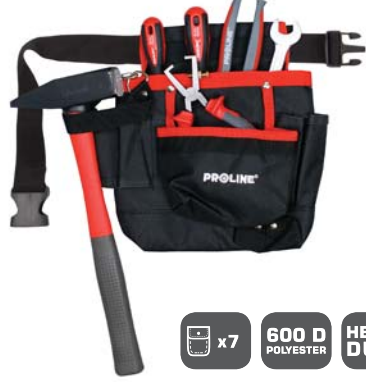

**x7** **600 D POLYESTER** **HEAVY DUTY**

- Belt fully adjustable to 117 cm
  - 7 pockets, 5 holders, 1 snap hook
- Please note: the pouch is sold without tools

Code	
52067	48

**5 TOOL POUCH**

• КАРМАН ДЛЯ ИНСТРУМЕНТОВ • WERKZEUGTASCHE



**x11** **600 D POLYESTER** **HEAVY DUTY**

- 1 large pocket, 10 smaller pockets
  - Perfect for hand tools, nails, drills, bits
- Please note: the pouch is sold without tools

Code	
52062	48

**6 TOOL POUCH WITH HAMMER HOLDER**

• КАРМАН ДЛЯ ИНСТРУМЕНТОВ С ДЕРЖАТЕЛЕМ ДЛЯ МОЛОТКА • WERKZEUGTASCHE MIT HAMMERHALTERUNG



**x1** **600 D POLYESTER** **HEAVY DUTY**

- Stainless steel handle
- Please note: the pouch is sold without tools

Code	
52061	96

**7 TOOL POUCH**

• КАРМАН ДЛЯ ИНСТРУМЕНТОВ • WERKZEUGTASCHE



**x8**  
**600 D POLYESTER**  
**HEAVY DUTY**

- 2 large pockets plus 6 smaller ones, 3 holders for hammers and pliers
- Please note: the pouch is sold without tools

Code	
52068	40

**8 TOOL POUCH**

• КАРМАН ДЛЯ ИНСТРУМЕНТОВ • WERKZEUGTASCHE



**x1** **600 D POLYESTER** **HEAVY DUTY**

- Perfect for hand tools, nails, drills, bits
- Please note: the pouch is sold without tools

Code	
52063	96

**9 POWER DRILL POUCH**

• КОБУРА ДЛЯ АККУМУЛЯТОРНОЙ ДРЕЛИ • BOHRERTASCHE



**x15** **600 D POLYESTER** **HEAVY DUTY**

- 1 large pocket and 14 smaller pockets for drills, bits
- Please note: the pouch is sold without tools

Code	
52066	24/48

**10 POWER DRILL POUCH**

• КОБУРА ДЛЯ АККУМУЛЯТОРНОЙ ДРЕЛИ • BOHRERTASCHE



**x5** **600 D POLYESTER** **HEAVY DUTY**

- 1 large pocket and 4 smaller pockets for drills, bits
- Please note: the pouch is sold without tools

Code	
52064	96



**1 HEAVY DUTY TOOL BELT WITH POUCHES**

- УСИЛЕННЫЙ МОНТЕРСКИЙ ПОЯС ДЛЯ ИНСТРУМЕНТА С КАРМАНАМИ
- HOCHLEISTUNGS-WERKZEUGGÜRTEL MIT TASCHEN

x16 600 D POLYESTER HEAVY DUTY

- Adjustable leather belt from 75 cm to 113 cm • 16 pockets, hammer holder and measuring tape holder



Please note: the pouches on the belt are sold without tools

Code	
52016	8

**2 HEAVY DUTY TOOL BELT WITH POUCHES**

- УСИЛЕННЫЙ МОНТЕРСКИЙ ПОЯС ДЛЯ ИНСТРУМЕНТА С КАРМАНАМИ
- HOCHLEISTUNGS-WERKZEUGGÜRTEL MIT TASCHEN

x21 NYLON HEAVY DUTY

- Adjustable leather belt from 80 cm to 115 cm • 21 pockets, 4 holders • Leather belt reinforcement



Please note: the pouches on the belt are sold without tools

Code	
52012	8

**3 TOOL BELT WITH POUCHES**

- МОНТЕРСКИЙ ПОЯС ДЛЯ ИНСТРУМЕНТА С КАРМАНАМИ
- WERKZEUGGÜRTEL MIT TASCHEN

x20 600 D POLYESTER HEAVY DUTY

- Belt fully adjustable from 82 cm to 112 cm
- 20 pockets, 2 hammer holders plus 1 measuring tape holder



Please note: the pouches on the belt are sold without tools

Code	
52020	24

**4 HEAVY DUTY TOOL BELT**

- МОНТЕРСКИЙ ПОЯС • HOCHLEISTUNGS-WERKZEUGGÜRTEL

- Leather belt reinforcement
- Adjustable from 75 to 113 cm

600 D POLYESTER HEAVY DUTY



Code	
52040	24

**5 HEAVY DUTY TOOL BELT**

- МОНТЕРСКИЙ ПОЯС УСИЛЕННЫЙ ДЛЯ КАРМАНОВ И КОБУР • HOCHLEISTUNGS-WERKZEUGGÜRTEL

- Leather belt reinforcement
- Adjustable leather belt from 80 cm to 115 cm

NYLON HEAVY DUTY



Code	
52041	24

**6 TOOL BELT**

- МОНТЕРСКИЙ ПОЯС ДЛЯ КАРМАНОВ И КОБУР • WERKZEUGGÜRTEL

- Adjustable from 75 to 129 cm

600 D POLYESTER HEAVY DUTY



Code	
52042	100

**7 TIE DOWN STRAPS, 2 ELEMENTS**

- РЕМНИ ДЛЯ КРЕПЛЕНИЯ ГРУЗОВ, ИЗ 2-Х ЧАСТЕЙ
- BINDEGÜRTE, 2 ELEMENTE

EN 12195-2

PES

- Two-element tie down straps with ratchet mechanism
- MATERIAL: polyester • Mixed colours



Code	Length (m)	LC (load carrying)		Strap width (mm)	
		Straight hanging [daN]	Wrapping around [daN]		
46750	4	250	500	25	30
46751	6	250	500	25	30
46752	8	250	500	25	25
46760	4	1000	2000	35	10
46761	6	1000	2000	35	10
46762	8	1000	2000	35	10
46770	4	2500	5000	50	10
46771	6	2500	5000	50	10
46772	8	2500	5000	50	10
46773	10	2500	5000	50	8

## GARDEN CARE TOOLS AND ACCESSORIES



- bags
- extension cords
- fittings
- garden hoses
- hose repairers
- pruning shears
- pitchforks
- rakes
- saws
- shears
- spades
- sprayers
- sprinklers
- stands
- quick connectors

**1 GARDEN HOSE**

• САДОВЫЙ ШЛАНГ • GARTENSCHLAUCH



- 4-layer flexible PVC hose • Working pressure 8 bar • Burst pressure of 24 bar • Temperature range -10°C to +60°C • UV and algae resistant
- Cadmium, barium, lead, and phthalate free

Code	Dimensions	Length (m)	☐
99412	1/2"	20	1
99413	1/2"	30	1
99415	1/2"	50	1
99422	5/8"	20	1
99423	5/8"	30	1
99425	5/8"	50	1
99432	3/4"	20	1
99433	3/4"	30	1
99435	3/4"	50	1
99442	1"	20	1
99443	1"	30	1
99445	1"	50	1

**2 GARDEN HOSE**

• САДОВЫЙ ШЛАНГ - ПРЕМИУМ • GARTENSCHLAUCH



- Double durability 4-layer flexible PVC hose with additives improving lowtemperature flexibility, resistant to bending and twisting • Working pressure 10 bar • Burst pressure of 30 bar • Temperature range -25°C to +60°C • UV and algae resistant • Cadmium, barium, lead, and phthalate free

Code	Dimensions	Length (m)	☐
99612	1/2"	20	1
99613	1/2"	30	1
99615	1/2"	50	1
99622	5/8"	20	1
99623	5/8"	30	1
99625	5/8"	50	1
99632	3/4"	20	1
99633	3/4"	30	1
99635	3/4"	50	1
99642	1"	20	1
99643	1"	30	1
99645	1"	50	1

**3 SUBMERSIBLE PUMP GARDEN HOSE**

• САДОВЫЙ ШЛАНГ ДЛЯ ПОГРУЖНЫХ НАСОСОВ • GARTENSCHLAUCH FÜR TAUCHPUMPEN

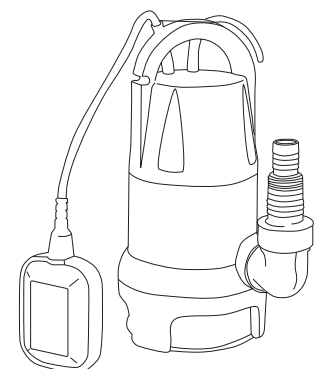

- Professional pump delivery hose

Code	Dimensions	Length (m)	☐
99001	1"	10	1

PROLINE

LANTTI PRO

MEGA

JUCO

OTHER BRANDS

ERDI

KLINGSPOR

EXPRESS

ACTION CAN

TRAYTON

VULCAN

## 1 GARDEN HOSE REEL

• ПОДСТАВКИ ДЛЯ САДОВЫХ ШЛАНГОВ • GARTENSCHLAUCHTROMMEL



ABS  
PP

METAL

• Easy installation without tools • Collapsible handle makes storage easier

Code	Length	
99391	45 m x 1/2" • 25 m x 3/4"	5
99392	60 m x 1/2" • 40 m x 3/4"	5

## 2 GARDEN HOSE CART

• ТЕЛЕЖКИ ДЛЯ САДОВОГО ШЛАНГА • GARTENSCHLAUCHWAGEN



METAL

ABS  
PP

• Easy installation without tools • Collapsible handle makes storage easier

Code	Length	
99393	45 m x 1/2" • 25 m x 3/4"	5
99394	60 m x 1/2" • 40 m x 3/4"	5



### 1 QUICK HOSE CONNECTORS

• КОННЕКТОРЫ СКВОЗНЫЕ • SCHNELLV ERBINDUNG - KUPPLUNG



Code	Dimensions	Packaging	
99200	1/2"	BULK	30/180
99201	1/2"	CARD	50/200
99500	1/2"	BOX	6
99204	3/4"	BULK	30/180
99205	3/4"	CARD	50/200
99504	3/4"	BOX	6



### 2 FEMALE THREAD TAP CONNECTORS

• АДАПТЕРЫ С ВНУТРЕННЕЙ РЕЗЬБОЙ • VERBINDER MIT INNENGEWINDE



Code	Dimensions	Packaging	
99208	1/2"	BULK	30/180
99209	1/2"	CARD	50/200
99508	1/2"	BOX	6
99210	3/4"	BULK	30/180
99211	3/4"	CARD	50/200
99510	3/4"	BOX	6
99212	1"	BULK	30/180
99213	1"	CARD	50/200
99512	1"	BOX	6



### 3 QUICK HOSE CONNECTORS WITH STOP

• КОННЕКТОРЫ БЛОКИРУЮЩИЕ  
• SCHNELLE SCHLAUCHANSCHLÜSSE MIT STOPP



Code	Dimensions	Packaging	
99202	1/2"	BULK	30/180
99203	1/2"	CARD	50/200
99502	1/2"	BOX	6
99206	3/4"	BULK	30/180
99207	3/4"	CARD	50/200
99506	3/4"	BOX	6



### 4 MALE THREAD TAP CONNECTORS

• АДАПТЕРЫ С ВНЕШНЕЙ РЕЗЬБОЙ • VERBINDER MIT AUSSENGEWINDE



Code	Dimensions	Packaging	
99214	3/4"	BULK	30/180
99215	3/4"	CARD	50/200
99514	3/4"	BOX	6



### 5 TWO WAY COUPLINGS

• АДАПТЕРЫ • ДВУХКАНАЛЬНЫЕ • KUPPLUNG



• Connector for 2 hoses using quick connections

Code	Packaging	
99218	BULK	30/180
99219	CARD	50/200
99518	BOX	6

### 6 THREE WAY COUPLINGS

• РАСПРЕДЕЛИТЕЛИ ТРЕХКАНАЛЬНЫЕ • Y-KUPPLUNG



• Connector for 3 hose endings using quick connections

Code	Packaging	
99216	BULK	30/180
99217	CARD	50/200
99516	BOX	6

PROLINE  
LAHTI PRO  
MEGA  
JUCO  
OTHER BRANDS  
ENDI  
KILGINGSPOR  
EXPRESS  
ACTION CAN  
TRYTON  
VILCANA

PROLINE

LANITI PRO

MEGA

JUCO

OTHER BRANDS

ERDI

KLINGSPOR

EXPRESS

ACTION CAN

TRAYTON

VULCAN

**1 MENDERS**

• МУФТЫ РЕПАРАТОРНЫЕ • REPARATOR



99220  
99222

99221  
99223

99520 (30 pcs.)  
99522 (30 pcs.)



• Mender for permanent connection of 2 hose ends

Code	Dimensions	Packaging	
99220	1/2"	BULK	30/180
99221	1/2"	CARD	50/200
99520	1/2"	BOX	6
99222	3/4"	BULK	30/180
99223	3/4"	CARD	50/200
99522	3/4"	BOX	6



**3 QUADRUPLE CONNECTOR**

• РАСПРЕДЕЛИТЕЛЬ ЧЕТЫРЕКАНАЛЬНЫЙ • VIERFACHSTECKER



• Connector enables to connect 2 hose ends to the water intake by means of quick connections • Each connection has adjustable water flow

Code		
99241	x	6/36

**5 MECHANICAL WATER TIMER**

• МЕХАНИЧЕСКИЙ ТАЙМЕР - 2 ЧАСА • MECHANISCHE WASSERUHR



• Timer with automatic switch • Manual watering time setting to max. 2h

Code		
99245	x	12/24

**2 FEMALE THREAD TAP CONNECTORS WITH ADAPTOR**

• АДАПТЕРЫ С ВНУТРЕННЕЙ РЕЗЬБОЙ И РЕДУКЦИЕЙ • VERBINDER MIT INNENGEWINDE MIT REDUKTION



99230  
99232

99231  
99233

99530 (30 pcs.)  
99532 (30 pcs.)



Code	Dimensions	Packaging	
99230	3/4" - 1"	BULK	30/180
99231	3/4" - 1"	CARD	50/200
99530	3/4" - 1"	BOX	6
99232	1/2" - 3/4"	BULK	30/180
99233	1/2" - 3/4"	CARD	50/200
99532	1/2" - 3/4"	BOX	6

**4 DOUBLE CONNECTOR**

• РАСПРЕДЕЛИТЕЛЬ ДВУХКАНАЛЬНЫЙ • 2-WEGE-VERTEILER



• Connector enables to connect 2 hose ends to the water intake by means of quick connections • Each connection has adjustable water flow

Code		
99243	x	24/144

**6 STRAIGHT SPRINKLERS**

• ОРОСИТЕЛИ ПРЯМЫЕ • REGNER GERADE



99300

99301

99600 (25 pcs.)



• Point and cone-shaped stream - smooth adjustment

Code	Packaging	
99300	BULK	25/150
99301	CARD	12/48
99600	BOX	6

**1 STRAIGHT SPRAY GUNS**

- ОРОСИТЕЛИ ПИСТОЛЕТНЫЕ, ПРЯМЫЕ
- BEWÄSSERUNGSSPRITZE GERADE



- Permanent operation lock • Smooth control of water jet from a strong point one to a delicate mist

Code	Packaging	
99302	BULK	6/36
99303	CARD	12/48
99602	BOX	6

**2 SPRAY GUNS 9 FUNCTIONS**

- ОРОСИТЕЛИ ПИСТОЛЕТНЫЕ 9-ФУНКЦИОНАЛЬНЫЕ • PISTOLENSPRITZE 9-FUNKTIONEN



- Permanent operation lock • Incremental water jet control in 9 different positions

Code	Packaging	
99304	BULK	4/24
99305	CARD	12/48
99604	BOX	6

**3 120° FAN SPRAY NOZZLE, SWIVEL**

- ОРОСИТЕЛЬ 120° ПРЯМОЙ, РЕГУЛИРУЕМЫЙ
- BEWÄSSERUNGSSPRITZE 1200 GEBOGEN



- Adjustment of head inclination • Push button switch

Code		
99307	x	12/48

**4 SPRAY GUN, 6 FUNCTIONS, SWIVEL**

- ОРОСИТЕЛЬ ПРЯМОЙ, 6-ФУНКЦИОНАЛЬНЫЙ, РЕГУЛИРУЕМЫЙ
- SPRITZPISTOLE, 6 FUNKTIONEN, SCHWENKBAR



- Adjustment of head inclination • Incremental water jet control in 6 different positions
- Push button switch

Code		
99309	x	24



**5 SPRAY GUN, 9 FUNCTION, METAL BODY**

- ОРОСИТЕЛЬ ПИСТОЛЕТНЫЙ, 9-ФУНКЦИОНАЛЬНЫЙ, МЕТАЛИЧЕСКИЙ • PISTOLENSPRITZE 9-FUNKTIONEN, METALL



- Permanent operation lock • Incremental water jet control in 9 different positions

Code		
99311	x	12/48

**7 SPRAY GUN DELUXE 11**

- ОРОСИТЕЛЬ ПИСТОЛЕТНЫЙ, ПРЯМОЙ DELUXE 11
- PISTOLENSPRITZE DELUXE 11



- Permanent operation lock • Stream force control

Code		
99315	x	6/24

**6 STRAIGHT SPRAY GUN BRASS**

- ОРОСИТЕЛЬ ПИСТОЛЕТНЫЙ BRASS, ПРЯМОЙ, ЛАТУННЫЙ
- PISTOLENSPRITZE BRASS01 GERADE, MESSING



- Point and cone-shaped stream - smooth adjustment • Permanent operation lock

Code		
99313	x	12/48

**8 SPRAY GUN DELUXE 12 - 9 FUNCTIONS**

- ОРОСИТЕЛЬ ПИСТОЛЕТНЫЙ DELUXE 12, 9-ФУНКЦИОНАЛЬНЫЙ
- PISTOLENSPRITZE DELUXE 12 - 9-FUNKTIONEN



- Incremental water jet control in 9 different positions

Code		
99317	x	6/24

PROLINE

LAHTI PRO

MEGA

JUCO

OTHER BRANDS

ERDI

KLINGSPOR

EXPRESS

ACTION CAN

TRAYTON

VULCAN

**1 STRAIGHT SPRINKLER KIT**  
 • НАБОР С ПРЯМЫМ ОРОСИТЕЛЕМ • SET MIT GERADER SPRITZE



1/2" 1/2" 3/4" ABS PP x4

Code		
99331	x	12/48

**2 SPRAY GUN KIT**  
 • НАБОР С ПИСТОЛЕТНЫМ ОРОСИТЕЛЕМ • SET MIT PISTOLENSPRITZE



1/2" 1/2" 3/4" ABS PP x4

Code		
99333	x	6/36

**3 SPRAY GUNS**  
 • ОРОСИТЕЛИ ПИСТОЛЕТНЫЕ, ПРЯМЫЕ • BEWÄSSERUNGSSPRITZE GERADE



ABS PP

- Permanent operation lock
- Water jet control by pressing a trigger

Code	Packaging	
99334	BULK	6/36
99335	CARD	12/48
99634	BOX	6



**4 OSCILLATING SPRINKLER 15 BRASS NOZZLES**  
 • МАЯТНИКОВЫЙ ОРОСИТЕЛЬ - 15 СОПЕЛ • OSZILLIERENDER SPRINKLER 15 MESSINGDÜSEN



max 146m<sup>2</sup> Zn-Cu ABS PP x 15

• Four-step sprinkling direction control

Code		
99351	x	12

**5 OSCILLATING SPRINKLER 15 NOZZLES**  
 • МАЯТНИКОВЫЙ ОРОСИТЕЛЬ - 15 СОПЕЛ • OSZILLIERENDER SPRINKLER 15 DÜSEN



max 151m<sup>2</sup> ABS PP x 15

• Four-step sprinkling direction control

Code		
99353	x	12



**1 STATIC SINGLE-FEATURE SPRINKLER**

- СТАЦИОНАРНЫЙ ОРОСИТЕЛЬ ОДНОФУНКЦИОНАЛЬНЫЙ
- STATISCHER REGNER



max 47m<sup>2</sup> ABS PP

- Perfect for small areas
- Possible to connect several spray guns in series

Code		
99355	x	12/48

**2 STATIC 5-FEATURE SPRINKLER**

- СТАЦИОНАРНЫЙ ОРОСИТЕЛЬ 5-ФУНКЦИОНАЛЬНЫЙ
- STATISCHER REGNER, 5-FUNKTIONEN



max 72m<sup>2</sup> ABS PP

- Perfect for small areas • Incremental water jet control in 5 different positions

Code		
99357	x	12/48

**3 ROTARY SPRINKLER**

- ВРАЩАЮЩИЙСЯ ОРОСИТЕЛЬ • KREISREGNER



max 50m<sup>2</sup> ABS PP

- 18 outlets • Three-arm spray gun with adjustable rotary speed of the sprayed surface by nozzle turning

Code		
99359	x	12/48

**4 METAL ROTARY SPRINKLER**

- ОРОСИТЕЛЬ ВРАЩАЮЩИЙСЯ, МЕТАЛЛИЧЕСКИЙ
- METALL-DREHSPRINKLER



360° max 92m<sup>2</sup> METAL

Code	Packaging	
99383	Cardboard box	12

**5 PULSATING SPRINKLER**

- ПУЛЬСИРУЮЩИЙ ОРОСИТЕЛЬ • IMPULSREGNER



max 415m<sup>2</sup> ABS PP

- Possible to connect several spray guns in series

Code		
99361	x	12/48



**7 METAL PULSATING SPLINKLER**

- ОРОСИТЕЛЬ ПУЛЬСИРУЮЩИЙ, ВРАЩАЮЩИЙСЯ, МЕТАЛЛИЧЕСКИЙ • SEKTOREN-IMPULSREGNER AUS METALL



360° max 532m<sup>2</sup> METAL

- Several sprinklers can be connected in a series • 360° rotation

Code		
99387	x	12/24

**8 120° FAN SPRAY NOZZLE DELUXE 03**

- ОРОСИТЕЛЬ ПРЯМОЙ 120° DELUXE 03 • REGNER 120 GR. DELUXE03



120° ABS METAL

- Spray gun start by a knob on the handle

Code		
99369	x	6/24

**9 SPRAY GUN DELUXE 01 - 9 FUNCTIONS**

- ОРОСИТЕЛЬ DELUXE 01 ПРЯМОЙ, 9-ФУНКЦИОНАЛЬНЫЙ
- REGNER DELUXE 01 - 9-FUNKTIONEN



METAL ABS PP

- Incremental water jet control in 9 different positions • Spray gun start by a knob on the handle

Code		
99365	x	6/24

**6 METAL PULSATING ROTARY SPRINKLER**

- ОРОСИТЕЛЬ ПУЛЬСИРУЮЩИЙ, СЕКТОРНЫЙ МЕТАЛЛИЧЕСКИЙ
- SEKTOREN-IMPULSREGNER AUS METALL



MAX 340° max 550m<sup>2</sup> METAL

- Several sprinklers can be connected in series • Adjustable sprinkling angle

Code		
99385	x	12/24

PROLINE

LANTTI PRO

MEGA

JUCO

OTHER BRANDS

ERDI

KLINGSPOR

EXPRESS

ACTION CAN

TRAYTON

VULCAN

**1 PATTERN SHOWER LANCE**

- ОРОСИТЕЛЬ DELUXE 04 ПРЯМОЙ, 9-ФУНКЦИОНАЛЬНЫЙ
- DELUXE04 - 9-FUNKTIONEN

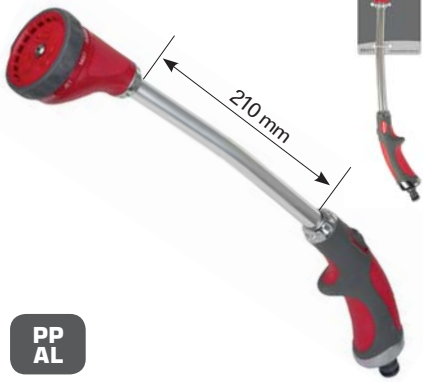

PP AL

- Incremental water jet control in 9 different positions • Spray gun start by a knob on the handle

Code		
99371	x	12

**2 SPRAY GUN DELUXE 02**

- ОРОСИТЕЛЬ ПРЯМОЙ DELUXE 02 • REGNER DELUXE 02



METAL ABS PP

- Control of water jet from a strong point one to a delicate mist • Spray gun start by a knob on the handle

Code		
99367	x	6/24

**3 SPRAY GUN, BRASS TRIGGER NOZZLE - 3 FUNCTIONS**

- ОРОСИТЕЛЬ ПИСТОЛЕТНЫЙ ПРЯМОЙ ЛАТУННЫЙ 3-ФУНКЦИОНАЛЬНЫЙ • PISTOLENSPRITZE GERADE 3-FK MESSING BRASS02



ABS BRASS

- Control of water jet from a strong point one to a delicate mist • 3-step permanent work lock

Code		
99373	x	12/48

**4 SPRAY GUN, BRASS TRIGGER NOZZLE**

- ОРОСИТЕЛЬ ПИСТОЛЕТНЫЙ ПРЯМОЙ ЛАТУННЫЙ
- PISTOLENSPRITZE GERADE 3-FK MESSING BRASS02



ABS BRASS

- Control of water jet from a strong point one to a delicate mist • Permanent operation lock

Code		
99375	x	12/48

**5 SPRAY GUN KIT, BRASS ADJUSTABLE NOZZLES 4 PC.**

- НАБОР С ПИСТОЛЕТНЫМ ПРЯМЫМ ОРОСИТЕЛЕМ 4 ШТ.
- SATZ MIT SPRITZE - 4-TLG. BRASS05



ABS BRASS

- Smooth control of water jet from a strong point one to a delicate mist • 3-step permanent work lock

Code		
99381	x	6/24

**6 SPRAY GUN DELUXE 16**

- ОРОСИТЕЛЬ ПИСТОЛЕТНЫЙ, МЕТАЛЛИЧЕСКИЙ DELUXE 16
- METALL PISTOLENSPRITZE DELUXE 16



METAL ABS

- Control of water jet
- Permanent operation lock

Code		
99325	x	12/48

**7 BRASS ADJUSTABLE NOZZL**

- ОРОСИТЕЛЬ ПРЯМОЙ ЛАТУННЫЙ • PISTOLENSPRITZE GERADE MESSING BRASS02



PP BRASS

- Smooth control of water jet from a strong point one to a delicate mist

Code		
99377	x	24/96

**8 SPRAY GUN DELUXE 17 - 8 FUNCTIONS**

- ОРОСИТЕЛЬ ПИСТОЛЕТНЫЙ, МЕТАЛЛИЧЕСКИЙ DELUXE 17, 8-ФУНКЦИОНАЛЬНЫЙ • METALL PISTOLENSPRITZE DELUXE 17



METAL ABS

- Incremental water jet type adjustment in 8 different positions

Code		
99327	x	12/48



**9 SPRAY GUN DELUXE 18**

- ОРОСИТЕЛЬ ПИСТОЛЕТНЫЙ, МЕТАЛЛИЧЕСКИЙ DELUXE 18, 10-ФУНКЦИОНАЛЬНЫЙ • METALL PISTOLENSPRITZE DELUXE 18



METAL ABS

- Incremental water jet type adjustment in 10 different positions

Code		
99329	x	6/12

**1 SPRAY GUN, SPRINKLER AND ACCESSORIES KIT, 313 PCS**

• НАБОР ВОДНОЙ СИСТЕМЫ, 313 ЭЛЕМЕНТОВ • VERBINDER- UND SPRITZENSATZ, 313-TLG.



Code	Opis	The quantity
99200	quick hose connector 1/2"	18
99202	quick hose connector with stop 1/2"	36
99204	quick hose connector 3/4"	18
99206	quick hose connector with stop 3/4"	18
99216	three way coupling	28
99218	two way coupling	45
99220	mender 1/2"	22
99222	mender 3/4"	35
99230	female thread tap connector 3/4"-1"	22
99232	female thread tap connector 3/4"-1"	35
99300	straight sprinkler	22
99304	spray gun 9 functions	6
99360	pulsing sprinkler 415 m <sup>2</sup>	8

ABS  
PP

Code	BOX	
99800	x	1



PROLINE

LAHTI PRO

MEGA

JUCO

OTHER BRANDS

ERDI

KLINGSPOR

EXPRESS

ACTION CAN

TRAYTON

VULCAN

**1 PITCHFORK, WOODEN SHAFT**

• ВИЛЫ САДОВЫЕ, ДЕРЕВЯННЫЙ ЧЕРЕНОК • HEUGABEL, HOLZSTIEL



• Classic pitchfork

Code	Dimensions (mm)	
12398	1200 x 230 x 310	6

**2 PITCHFORK, METAL SHAFT**

• ВИЛЫ САДОВЫЕ, МЕТАЛЛИЧЕСКИЙ ЧЕРЕНОК • HEUGABEL, METALL STIEL



• Classic pitchfork

Code	Dimensions (mm)	
12397	1200 x 230 x 310	6

**3 DIGGING FORK, WOODEN SHAFT**

• ВИЛЫ ДЛЯ КОПАНИЯ, ДЕРЕВЯННЫЙ ЧЕРЕНОК • HEUGABEL ZUM GRABEN, HOLZSTIEL



• Wide teeth, perfect for digging

Code	Dimensions (mm)	
12396	1200 x 200 x 290	6

**4 DIGGING FORK, METAL SHAFT**

• ВИЛЫ ДЛЯ КОПАНИЯ, МЕТАЛЛИЧЕСКИЙ ЧЕРЕНОК • HEUGABEL ZUM GRABEN, METALL STIEL



• Wide teeth, perfect for digging

Code	Dimensions (mm)	
12395	1200 x 200 x 290	6

**5 SHAFTS FOR RAKE**

• ЧЕРЕНКИ ДЛЯ ГРАБЛЕЙ • STIELE FÜR RECHEN



• Easy tool-free click installation • Handles fit to removable Proline heads: 14313, 14314, 14315, and 14316

Code	Material	Length (mm)	Diameter (mm)	
14311	pine wood	1500	22	10
14312	aluminum	1600	22	10

**6 RAKES**

• ГРАБЛИ • HARKEN

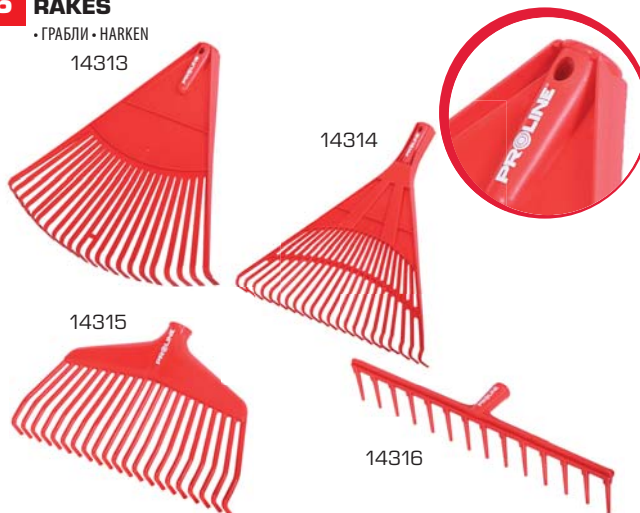

• Easy tool-free click installation • Durable, flexible teeth made from high quality plastic • Handles fit to removable Proline heads: 14313, 14314, 14315, and 14316

Code	Type	Width (mm)	Quantity of teeth	
14313	leaf rakes	490	22	10
14314	leaf rakes	500	22	10
14315	small for leaves	380	21	10
14316	universal for hay	540	14	10



**1 HAND PRUNER PREMIUM**

• СЕКАТОР САДОВЫЙ ПРЕМИУМ  
• КОВАНЫЙ • GARTENSCHERE



max 20 mm HRC 50±2

- Scissor type • Carbon steel blade, quenched
- Handles coated with wood

Code	Max. cutting diameter (mm)		
40016	20	x	12/60

**2 HAND PRUNER PREMIUM**

• СЕКАТОР САДОВЫЙ ПРЕМИУМ ДЛЯ ЦВЕТОВ - КОВАНЫЙ  
• GARTENSCHERE PREMIUM FÜR BLUMEN - GESCHMIEDET



max 20 mm HRC 50±2

- Scissors type • Carbon steel, quenched blade
- Handles coated with wood

Code	Max. cutting diameter (mm)		
40017	20	x	12/60

**3 HAND PRUNER PREMIUM**

• СЕКАТОР САДОВЫЙ С НАКОВАЛЕНКОЙ ПРЕМИУМ  
• GARTENSCHERE



max 16 mm HRC 46±2 65 Mn PTFE

- Anvil type • Manganese steel blade
- Two-component non-slip handle - ABS/TPR

Code	Max. cutting diameter (mm)		
40019	16	x	12/48

**4 HAND PRUNER PREMIUM**

• СЕКАТОР САДОВЫЙ ПРЕМИУМ • GARTENSCHERE



max 16 mm HRC 46±2 65 Mn PTFE

- Scissor type • Manganese steel blade
- Two-component non-slip handle - ABS/TPR

Code	Max. cutting diameter (mm)		
40018	16	x	12/48

**5 HAND PRUNER**

• СЕКАТОР САДОВЫЙ  
• GARTENSCHERE



max 25 mm HRC 50±2

- Forged blade
- Very long lifecycle and reliable work

Code	Max. cutting diameter (mm)		
40012	25	x	6/48

**6 HAND PRUNERS**

• СЕКАТОРЫ САДОВЫЕ • GARTENSCHEREN



PTFE HRC 50±2

- Reliable work in intense use

Code	Max. cutting diameter (mm)		
40008	12	x	10/60
40015	19	x	12/48

**7 HAND PRUNER**

• СЕКАТОР САДОВЫЙ С НАКОВАЛЕНКОЙ • GARTENSCHERE



max 19 mm PTFE HRC 50±2

- Anvil type, two-component handle

Code	Max. cutting diameter (mm)		
40013	19	x	12/72

**8 HAND PRUNER**

• СЕКАТОР САДОВЫЙ • GARTENSCHERE



max 19 mm PTFE HRC 50±2

- Scissor type • Two-component handle

Code	Max. cutting diameter (mm)		
40011	19	x	12/72

**9 BYPASS LOPPERS PREMIUM**

• СУЧКОРЕЗ ПРЕМИУМ • ASTSCHERE

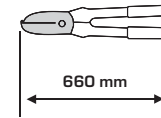

max 32 mm 65 Mn PTFE HRC 46±2

- Anvil type • Manganese steel blade
- Aluminium arms • Non-slip TPR handle

Code	Max. cutting diameter (mm)		
40032	32	x	6/12

**10 BYPASS LOPPERS PREMIUM**

• СУЧКОРЕЗ ПРЕМИУМ • ASTSCHERE

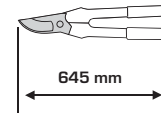

max 32 mm 65 Mn PTFE HRC 46±2

- Anvil type • Manganese steel blade
- Telescopic aluminium arms • Non-slip TPR handle

Code	Max. cutting diameter (mm)		
40033	32	x	6/12

**11 BYPASS LOPPERS PREMIUM**

• СУЧКОРЕЗ ПРЕМИУМ • ASASTSCHERE PREMIUM

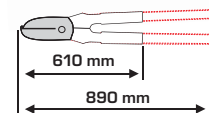

max 38 mm 65 Mn PTFE HRC 46±2

- Anvil-type • Manganese blade, coated
- Telescopic aluminium arms with adjustable length • Non-slip TPR handle

Code	Max. cutting diameter (mm)		
40034	38	x	6/12

PROLINE

LAHTI PRO

MEGA

JUCO

OTHER BRANDS

ERDI

KLINGSPOR

EXPRESS

ACTION CAN

TRYTON

VULCAN

**1 BYPASS LOPPERS PREMIUM**

• СУЧКОРЕЗ ПРЕМИУМ • ASASTSCHERE PREMIUM

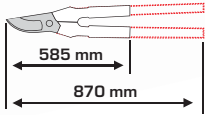

max 32 mm **65 Mn** **PTFE** **HRC 46±2**

- Scissors-type • Manganese blade • Telescopic aluminium arms • Non-slip TPR handle

Code	Max. cutting diameter (mm)		
40035	32	x	6/12

**5 BYPASS LOPPERS**

• СУЧКОРЕЗ • ASTSCHERE

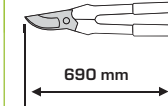

max 40 mm **PTFE** **HRC 50±2**

Code	Max. cutting diameter (mm)		
40026	40	x	6



**3 BYPASS LOPPERS**

• СУЧКОРЕЗ • ASTSCHERE

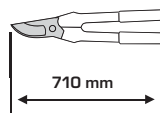

max 34 mm **PTFE** **HRC 50±2**

- Aluminium arms

Code	Max. cutting diameter (mm)		
40028	34	x	6

**6 BYPASS LOPPERS**

• СУЧКОРЕЗ • ASTSCHERE

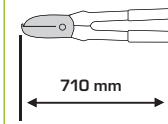

max 44 mm **PTFE** **HRC 50±2**

- Aluminium arms • Anvil type
- Lever mechanism ensuring easier cutting

Code	Max. cutting diameter (mm)		
40031	44	x	6

**2 BYPASS LOPPERS**

• СУЧКОРЕЗ • ASTSCHEREN

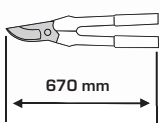

max 44 mm **HRC 50±2**

Code	Max. cutting diameter (mm)		
40040	44	x	6

**4 BYPASS LOPPERS**

• СУЧКОРЕЗ • ASTSCHERE

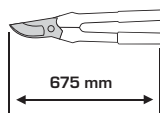

max 40 mm **PTFE** **HRC 50±2**

Code	Max. cutting diameter (mm)		
40024	40	x	12

**7 BYPASS LOPPERS**

• СУЧКОРЕЗ • ASTSCHERE

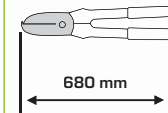

max 40 mm **PTFE** **HRC 50±2**

- Anvil type with anvil position adjustment

Code	Max. cutting diameter (mm)		
40027	40	x	6

**1 BYPASS LOPPERS**

• СУЧКОРЕЗ • ASTSCHERE



• Anvil type with anvil position adjustment

Code	Max. cutting diameter (mm)		
40025	38	x	6

**2 BYPASS LOPPERS**

• СУЧКОРЕЗ • ASTSCHERE



• Lever mechanism ensuring easier cutting

Code	Max. cutting diameter (mm)		
40030	32	x	6

**3 BYPASS LOPPERS**

• СУЧКОРЕЗ • ASTSCHERE



• Aluminium arms, telescopic, with adjustable length • Lever mechanism ensuring easier cutting

Code	Max. cutting diameter (mm)		
40042	30	x	6

**4 HEDGE SHEARS PREMIUM**

• НОЖНИЦЫ ДЛЯ ЖИВОЙ ИЗГОРОДИ • HECKENSCHEREN PREMIUM



• Wavy blades from manganese steel • Blade pressure adjustment • Telescopic aluminium arms with adjustable length • Non-slip TPR handle

Code	Blade length (mm)		
40036	210	x	12

**5 HEDGE SHEARS TELESCOPIC PREMIUM**

• НОЖНИЦЫ ДЛЯ ЖИВОЙ ИЗГОРОДИ ТЕЛЕСКОПИЧЕСКИЕ ПРЕМИУМ • HECKENSCHERE AUSZIEHBAR PREMIUM



• Wavy blades from manganese steel • Blade pressure adjustment • Telescopic aluminium arms with adjustable length • Non-slip TPR handle

Code	Blade length (mm)		
40037	210	x	12

**6 HEDGE SHEARS**

• НОЖНИЦЫ ДЛЯ ЖИВОЙ ИЗГОРОДИ • HECKENSCHERE



• Wavy blade • Blade pressure adjustment

Code	Blade length (mm)		
40045	200	x	6

**7 HEDGE SHEARS**

• НОЖНИЦЫ ДЛЯ ЖИВОЙ ИЗГОРОДИ • HECKENSCHERE



• Wavy blade • Blade pressure adjustment

Code	Blade length (mm)		
40050	250	x	6

PROLINE

LANIT PRO

MEGA

JUCO

OTHER BRANDS

ERDI

KLINGSPOR

EXPRESS

ACTION CAN

TRYTON

VULCAN

### 1 GRASS SHEARS

- НОЖНИЦЫ ДЛЯ ТРАВЫ
- GRASSCHERE

**HRC**  
50±2



- Single position

Code	Blade length (mm)		
40052	125	x	12/48

### 2 GRASS SHEARS

- НОЖНИЦЫ ДЛЯ ТРАВЫ
- GRASSCHERE

**HRC**  
50±2

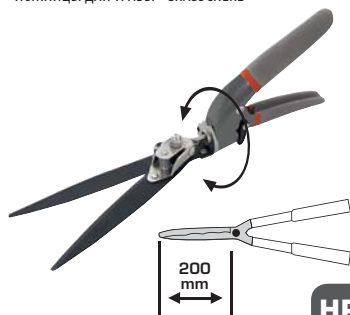

- Three positions, rotational, enabling different angles of blade positioning; horizontal, vertical and gradient cutting

Code	Blade length (mm)		
40054	200	x	12/48

### 3 TELESCOPIC TREE PRUNER WITH SAW

- СЕКАТОР ТЕЛЕСКОПИЧЕСКИЙ С ПИЛОЙ ДЛЯ ВЕТОК
- AUSZIENBARE BAUMSCHERE MIT SÄGE



max 24mm 250mm SK5 AL HRC 46±2

- Lightweight aluminium design with an adjustable handle length
- Garden shears with a simple cable mechanism
- Additional screwed pruning saw

Code	Length (mm)	
40039	1410 - 2250	10

### 4 PREMIUM GARDEN SAW

- ПИЛА СКЛАДНАЯ ПРЕМИУМ
- PREMIUM GARTENSÄGE

SK5 HRC 45±2



- Blade lock
- Two-component handle - ABS/TPR

Code	Blade length (mm)		
64426	145	x	12/48

### 5 UNIVERSAL GARDEN SAW

- УНИВЕРСАЛЬНАЯ САДОВАЯ ПИЛА
- UNIVERSAL GARTENSÄGE

300mm HRC 56±2



- Ergonomic handle with thumb profile, facilitates gradient cutting
- Delivered with a sheath for the cutting part which can be fixed on a belt
- Americanstyle teeth, quenched for fresh and moist wood, boards, planks and soft construction materials

Code	Blade length (mm)		
64430	300	x	6/24

### 6 ALUMINIUM GARDEN TOOLS FLORAL

- ИНСТРУМЕНТЫ САДОВО-ОГОРОДНЫЕ АЛЮМИНИЕВЫЕ FLORAL
- ALU-GARTENWERKZEUGE FLORAL



AL

Code	Type	
40080	wide trowel	12/72
40081	rake	12/72
40082	fork	12/72

### 7 ALUMINIUM GARDEN TOOLS

- САДОВЫЕ АЛЮМИНИЕВЫЕ ИНСТРУМЕНТЫ
- ALU-GARTENWERKZEUGE



AL

- Rigid
- Stainless
- Ergonomic handles

Code	Type	
40065	wide trowel	25
40066	narrow trowel	25
40068	rake	12

### 8 FIBREGLASS GARDEN TOOLS

- САДОВЫЕ ИНСТРУМЕНТЫ ИЗ СТЕКЛОВОЛКНА
- GL ASFASER-GARTENWERKZEUGE



FRP

- Rigid
- Ergonomic handles

Code	Type	
40060	wide trowel	25
40061	narrow trowel	25
40062	rake	25

### 9 STEEL GARDEN TOOLS

- САДОВЫЕ СТАЛЬНЫЕ ИНСТРУМЕНТЫ
- STAHL-GARTENWERKZEUGE



- From hardened steel
- Ergonomic handles

Code	Type	
40070	wide trowel	24
40071	narrow trowel	24
40072	fork with pickaxe	24
40073	rake	24



**1 WOVEN RUBBLE BAGS**

- МЕШКИ (ПАКЕТЫ) ДЛЯ МУСОРА ТКАНЫЕ
- GEWEBTE SCHUTTBEUTEL



PP

x10

- To collect debris in the repair and construction work

Code	Dimensions (mm)	Packaging	
41216	600 x 1050	plastic bag	28
41217	700 x 1100	plastic bag	25

**2 LDPE RUBBLE BAGS**

- МЕШКИ (ПАКЕТЫ) ДЛЯ МУСОРА LDPE • LDPE SCHUTTBEUTEL



LDPE

SUPER STRONG

- Bags for household supplies • Renovation, construction

Code	Quantity in a pack (pcs.)	Volume (l)	
41206	10	80	5
41207	10	120	5

**3 LDPE WASTE BAGS**

- МЕШКИ (ПАКЕТЫ) ДЛЯ МУСОРА LDPE
- LDPE MÜLLSÄCKE



LDPE

- Bags for household supplies • Sold in packs of 8

Code	Quantity in a roll (pcs.)	Volume (l)	Colour	
41202	20	60	black	8/24
41203	10	120	black	8/24
41204	10	120	red	8/24
41205	10	120	green	8/24

**4 EXTENSION CABLES IP44**

- УДЛИНИТЕЛИ IP44 С ЗАЕМЛЕНИЕМ
- VERLÄNGERUNGSKABEL IP44



IP44

- Made from high quality materials • 1 grounded socket • Max load up to 4000W 16A with folded cable • Delivered in a plastic bag • Polish product
- \* with unfolded cable

Code	Max. load*	Length (m)	
PEP20UZ	4000W 16A	20	10



**1 PREMIUM PRESSURE SPRAYERS**

• ОПРЫСКИВАТЕЛИ ПРЕМИУМ • PREMIUM-DRUCKSPRÜHGERÄTE



• Expendable lance 490-880 mm • Shoulder strap included • High performance and ergonomics

Code	Volume (l)	Box
07905	5	6
07908	8	6

**2 PREMIUM PRESSURE SPRAYERS**

• ОПРЫСКИВАТЕЛИ ПРЕМИУМ • PREMIUM-DRUCKSPRÜHGERÄTE



• Long nozzle 90 mm • High efficiency and ergonomics

Code	Volume (l)	Box
07901	1.5	20
07902	2	10



**3 SPRAYERS**

• ОПРЫСКИВАТЕЛИ • SPRÜHER

079003  
079007  
079011

079015  
079020



Code	Volume (l)	Box
079015	1.5	15
079020	2	15
079003	3	6
079007	7	6
079011	11	6

**4 KNAPSACK SPRAYER**

• РУЧНОЙ ОПРЫСКИВАТЕЛЬ • RUCKSACK-SPRÜHER



Code	Volume (l)	Qty of nozzles	Box
079016	16	4	1

**5 TARPULINS**

• САДОВЫЕ ПОЛИЭТИЛЕНОВЫЕ АРМИРОВАННЫЕ ТЕНТЫ • ABDECKPLANE



• 2-year resistance to UV rays • Reinforced edge and corners • Aluminium eyelets

Code	Dimensions (m +/- 5%)	Box
46423	2 x 3	30
46435	3 x 5	12
46445	4 x 5	9
46446	4 x 6	8
46458	5 x 8	5
46461	6 x 10	3
46481	8 x 12	2
46411	10 x 15	1

**1 TRIMMING LINE**

• РЕЖУЩИЕ ЛЕСКИ (КАТУШКА) • TRIMMERSCHNUR



• For all hedge trimmers and string cutters available on the market

Code	Profile	Diameter	Length (mm)	Colour	☐
98214		2,4	90	Yellow	27
98215		2,7	70	Yellow	27
98216		3	56	Yellow	27
98224		2,4	90	Orange	27
98225		2,7	70	Orange	27
98226		3	56	Orange	27
98234		2,4	90	Red	27
98235		2,7	70	Red	27
98236		3	56	Red	27
98244		2,4	90	Blue	27
98245		2,7	70	Blue	27
98246		3	56	Blue	27
98254		2,4	90	Black	27
98255		2,7	70	Black	27
98256		3	56	Black	27

**2 TRIMMING LINE**

• РЕЖУЩИЕ ЛЕСКИ (КАТУШКА) • TRIMMERSCHNUR



**String design vs usability**

string design	round	square	star	twisted square	reinforced square
cutting speed	★★★	★★★★	★★★★★	★★★★★	★★★★★
durability	★★★★	★★★★★	★★★	★★★★★	★★★★★
quiet work	★★★	★★★★	★★★	★★★★★	★★★★★

★ low parameter value      ★★★★★ highest parameter value

- Made of high quality nylon
- Strings with a round form with a diameter of 1.3 mm and 1.6 mm are used in trimmers (e.g. Tryton TOB650, TOB25301) for lawn care and cutting low grass
- Strings that are: round, spiral and square with diameters from 2 mm to 3 mm are used in combustion engine trimmers (e.g. Tryton TOP252S, TOP431S) for cutting high grass and weeds. In the case of these strings, work is easiest when the Easy-load automatic trimmer head is used (EATOP01)

Code	Profile	Diameter	Length (mm)	Colour	☐
98111		1,3	15	Yellow	20 / 240
98112		1,6	15	Yellow	20 / 240
98113		2	15	Yellow	18 / 216
98114		2,4	15	Yellow	16 / 192
98115		2,7	15	Yellow	12 / 144
98116		3	15	Yellow	10 / 120
98121		1,3	15	Orange	20 / 240
98122		1,6	15	Orange	20 / 240
98123		2	15	Orange	18 / 216
98124		2,4	15	Orange	16 / 192
98125		2,7	15	Orange	12 / 144
98126		3	15	Orange	10 / 120
98131		1,3	15	Red	20 / 240
98132		1,6	15	Red	20 / 240
98133		2	15	Red	18 / 216
98134		2,4	15	Red	16 / 192
98135		2,7	15	Red	12 / 144
98136		3	15	Red	10 / 120
98144		2,4	15	Blue	16 / 192
98145		2,7	15	Blue	12 / 144
98146		3	15	Blue	10 / 120
98154		2,4	15	Black	16 / 192
98155		2,7	15	Black	12 / 144
98156		3	15	Black	10 / 120



**SHOVELS, SPADES - PAGES 166-167**  
**AXES - PAGES 167-168**







## ACCESSORIES FOR POWER TOOLS

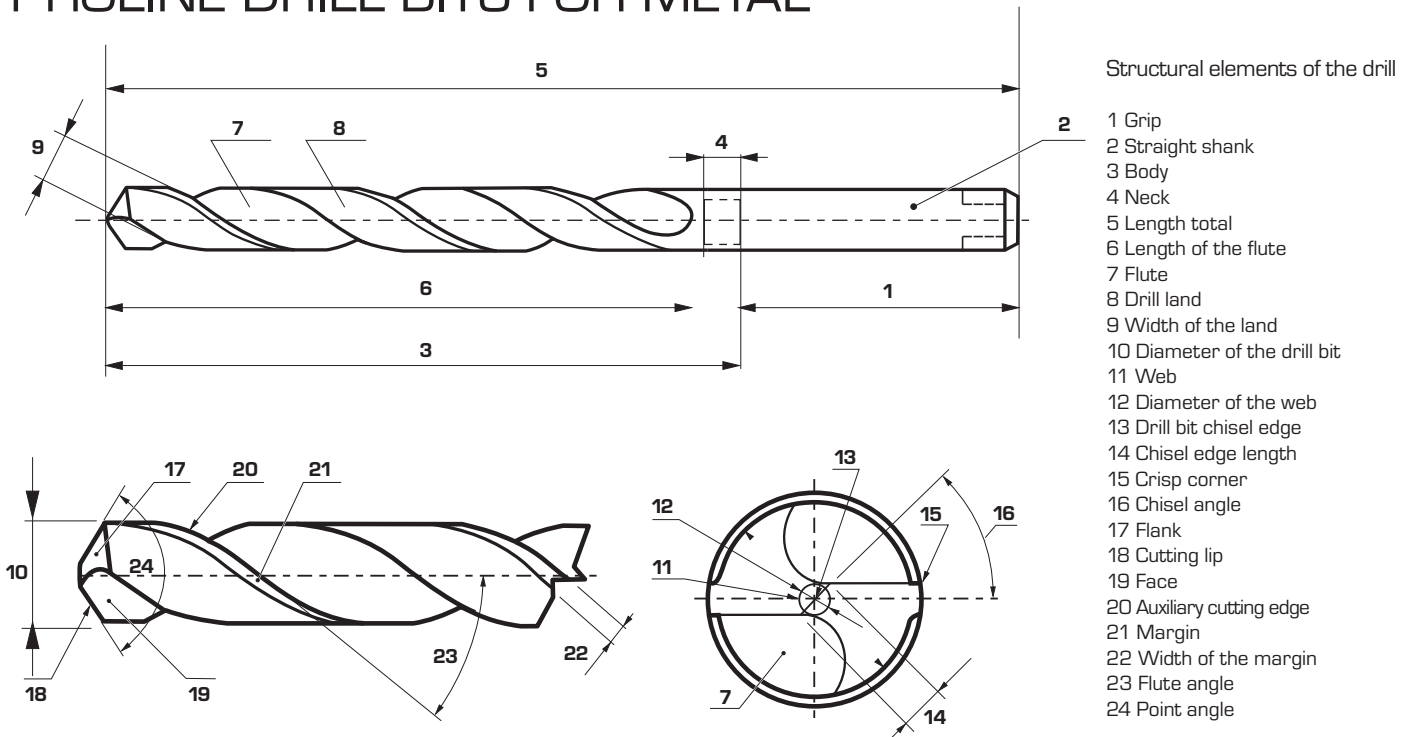

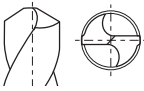
**adaptors**  
**accessories**  
**blades**  
**chisels**  
**circular saws**  
**discs**  
**drills**  
**hole saws**  
**router bits**  
**sand papers**  
**technical brushes**  
**and many others**

# PROLINE DRILL BITS FOR METAL



Description	Characteristics	Technical parameters
 <p><b>HSS DRILLS FOR METAL (without chisel modification)</b></p>	<p>Sharpened and normally ground, which allows these drills to be used for all ordinary drilling in steel, non-ferrous metals and plastics. The cutting angle is suitable to the machinability of the processed material. Benefits: strong main cutting edges, insensitive to impact and lateral forces. Simple cut, possibility of manual sharpening.</p>	 <p>conical cut</p> <p>Point angle: 118° standard. Edge grinding: conical. Material: efficiency improved high-speed steel HSS</p>
 <p><b>HSS DRILL BITS FOR METAL (with chisel modification)</b></p>	<p>Drill bits made entirely by grinding - they guarantee high accuracy and straight openings, and an efficiency several times higher than for roll-forged or surface-ground drills. Material - high speed steel of the highest quality. Increased abrasion resistance. Increased elasticity and resistance to torsional stress.</p>	 <p>two-chisel cut</p> <p>Point angle of 135° with chisel modification - allows holes to be made quickly while saving time on making divots. Material: efficiency improved high-speed steel HSS</p>
 <p><b>DRILL BITS FOR METAL HSS Co</b></p>	<p>For drilling in high-alloy steels, titanium, acid-resistant, stainless, heat-resistant steels and cast iron (strength above 900 N/m<sup>2</sup>) and other difficult to machine materials.</p>	 <p>two-chisel cut</p> <p>Point angle 135° with chisel modification - allows quick drilling while saving time when making divots. High temperature resistance. Material: efficiency improved HSS high-speed steel Cobalt Co.</p>
 <p><b>HSS TiN DRILL BITS FOR METAL</b></p>	<p>Drills made completely by grinding, coated with titanium nitride that increases the life of the drill bits and improves the quality of holes made</p>	 <p>two-chisel cut</p> <p>Point angle of 135° with chisel correction - allows holes to be made quickly while saving time on making divots. Material: high-speed steel HSS coated with titanium nitride TiN</p>

# СВЕРЛА ПО МЕТАЛЛУ PROLINE

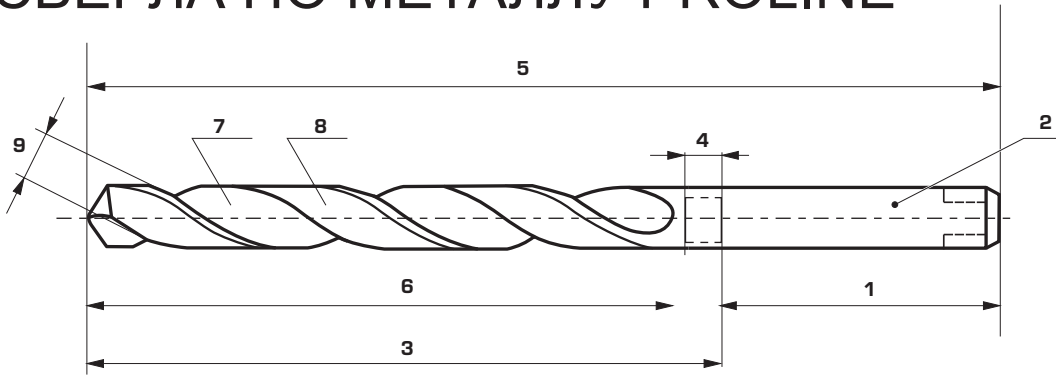

Конструкционные элементы сверла

- 1 Держатель
- 2 Прямой хвостовик
- 3 Корпус
- 4 Шейка
- 5 Общая длина
- 6 Длина канавки
- 7 Канавка
- 8 Ленточка сверла
- 9 Ширина ленточки
- 10 Диаметр сверла
- 11 Перемычка
- 12 Диаметр перемычки
- 13 Лезвие сверла
- 14 Длина лезвия
- 15 Ломкий угол
- 16 Угол лезвия
- 17 Задняя грань
- 18 Режущая кромка
- 19 Режущая поверхность
- 20 Вспомогательная режущая кромка
- 21 Кромка
- 22 Ширина кромки
- 23 Угол канавки
- 24 Угол при вершине

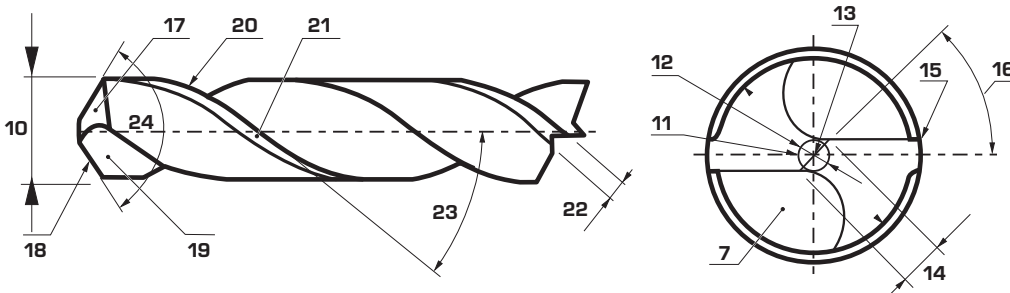

Описание

Характеристики

Технические параметры

**СВЕРЛА ПО МЕТАЛЛУ HSS (без модификации лезвия)**

Заточенные и шлифованные, что позволяет использовать эти сверла для обычного сверления стали, цветных металлов и пластмасс. Угол резания подходит для возможности обработки материала. Преимущества: прочные основные режущие кромки, нечувствительные к ударам и боковым нагрузкам. Простота реза, возможность ручной заточки.



коническая резка

Угол при вершине: Стандарт 118°. Заточка кромки: коническая. Материал: улучшенная быстрорежущая сталь HSS

**СВЕРЛА ПО МЕТАЛЛУ HSS (с модификацией лезвия)**

Сверла, изготовленные исключительно шлифованием - гарантируют высокую точность и прямолинейность отверстий, а эффективность в несколько раз выше, чем у штампованных или шлифованных сверл. Материал - высококачественная быстрорежущая сталь. Повышенная абразивная стойкость. Повышенная эластичность и устойчивость к скручивающим нагрузкам.



резец с двумя лезвиями

Угол при вершине 135° с модификацией лезвия - позволяет быстро сверлить отверстия, экономя время на изготовление выемок. Материал: улучшенная быстрорежущая сталь HSS

**СВЕРЛА ПО МЕТАЛЛУ HSS Co**

Для сверления высоколегированных, титановых, кислотостойких, нержавеющей сталей, жаропрочных сталей и чугуна (прочность выше 900 Н/м²) и других трудно обрабатываемых материалов.



двукратный разрез

Угол наклона 135° с коррекцией сдвига - позволяет быстро делать отверстия, экономя время для простановки меток. Высокая термостойкость. Материал: сталь HSS для быстрой резы с кобальтовым покрытием Co.

**СВЕРЛА ПО МЕТАЛЛУ HSS TiN**

Полностью шлифованные сверла покрытые нитридом титана, что увеличивает срок службы и повышает качество просверленных отверстий







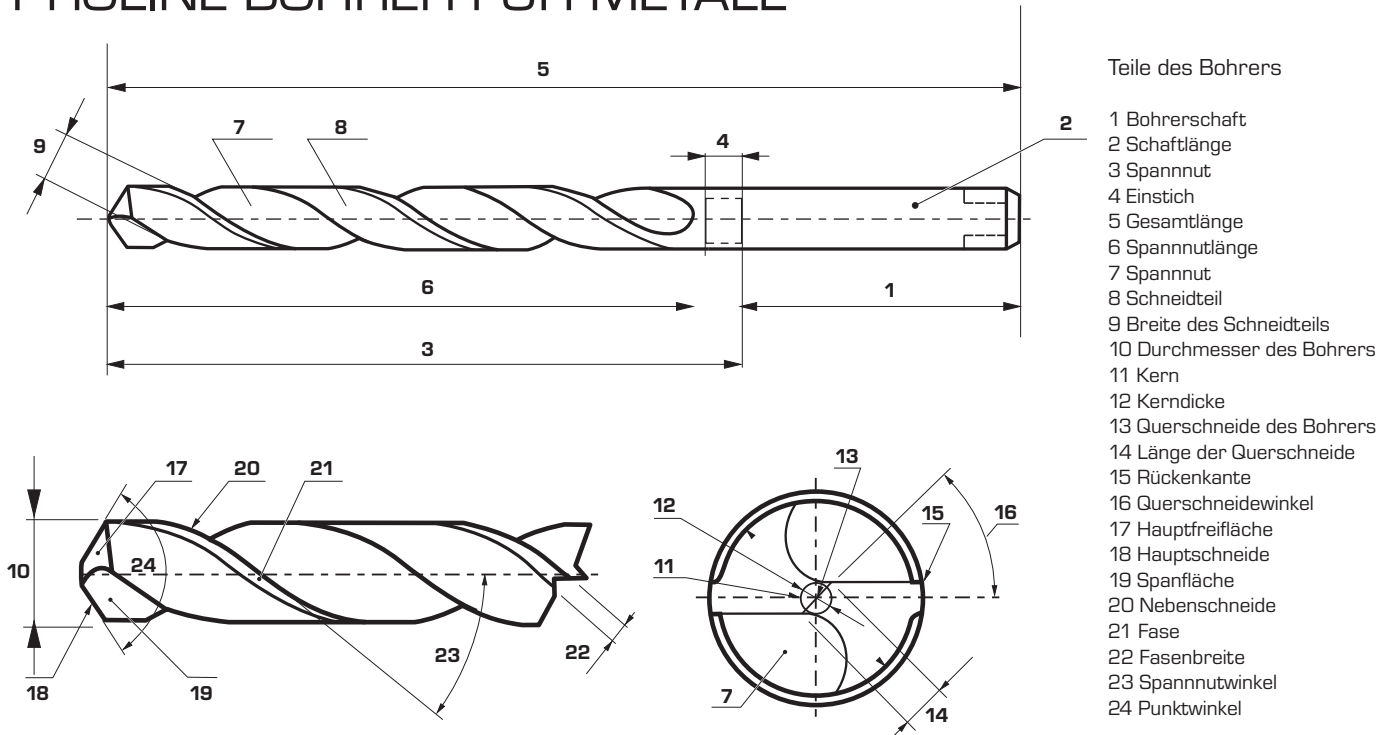

резец с двумя лезвиями

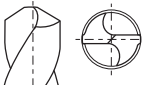
Угол при вершине 135° с модификацией лезвия - позволяет быстро сверлить отверстия, экономя время на изготовление выемок. Материал: быстрорежущая сталь HSS, покрытая нитридом титана TiN

# PROLINE BOHRER FÜR METALL

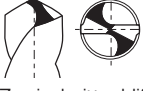

Beschreibung	Eigenschaften	Technische Parameter
 <p><b>HSS-BOHRER FÜR METALL (ohne Modifikation der Querschneide)</b></p>	<p>Geschärft und normalerweise geschliffen, wodurch diese Bohrer für alle gewöhnlichen Bohrungen in Stahl, NE-Metallen und Kunststoffen verwendet werden können. Der Schnittwinkel ist für die maschinelle Bearbeitbarkeit des bearbeiteten Materials geeignet. Vorteile: starke Hauptschneidkanten, unempfindlich gegen Stöße und seitliche Kräfte. Einfacher Schnitt, manuelles Nachschärfen möglich.</p>	 <p>konischer Schnitt</p> <p>Punktwinkel: 118°, standardmäßig. Kantenschliff: konisch Material: Hochleistungsschnellarbeitsstahl HSS</p>
 <p><b>HSS-BOHRER FÜR METALL (mit Modifikation der Querschneide)</b></p>	<p>Vollständig durch Schleifen gefertigte Bohrer - stellen eine hohe Genauigkeit und gerade Öffnungen sowie einen um ein Vielfaches höheren Wirkungsgrad sicher als bei geschmiedeten oder oberflächengeschliffenen Bohrern. Material - Hochleistungsschnellarbeitsstahl der besten Qualität. Erhöhte Abriebfestigkeit. Erhöhte Elastizität und Beständigkeit gegen Torsionsbelastungen.</p>	 <p>Zwei-Querschneide-Schnitt</p> <p>Punktwinkel von 135° mit Modifikation der Querschneide - ermöglicht das schnelle Durchführen von Bohrungen, wobei Zeit bei der Herstellung von Bohrlöchern gespart wird. Material: Hochleistungsschnellarbeitsstahl HSS</p>
 <p><b>BOHRER FÜR METALL HSS Co</b></p>	<p>Für Bohrungen in hochlegiertem Stahl, Titanstahl, säurebeständigen Stahl, Edelstahl, hitzebeständigem Stahl und Gusseisen (Festigkeiten über 900 N / m²) und anderen Materialien, deren Bearbeitung anspruchsvoll ist.</p>	 <p>Zweischnitts-schliff</p> <p>Scheitelwinkel 135° mit Schnittkorrektur - ermöglicht das schnelle Durchführen von Bohrungen, wobei Zeit bei der Punktierung gespart wird. Hohe Temperaturbeständigkeit. Material: Hochleistungsschnellarbeitsstahl HSS mit Kobaltbeschichtung Co.</p>
 <p><b>HSS TiN BOHRER FÜR METALL</b></p>	<p>Vollständig durch Schleifen gefertigte Bohrer, mit Titanitrid beschichtet, wodurch die Lebensdauer der Bohrer und die Qualität der Bohrlöcher gesteigert wird.</p>	 <p>Zwei-Querschneide-Schnitt</p> <p>Punktwinkel von 135° mit Korrektur der Querschneide - ermöglicht das schnelle Durchführen von Bohrungen, wobei Zeit bei der Herstellung von Bohrlöchern gespart wird. Material: Hochleistungsschnellarbeitsstahl HSS mit Titanitridbeschichtung TiN</p>





**1 HSS TWIST DRILLS**

• СВЕРЛА ПО МЕТАЛЛУ ИЗ СТАЛИ HSS • METALLBOHRER HSS

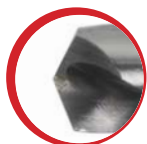

- **Nose angle 135° with chamfering adjustment** - enables to make holes quickly, saving time when punching
- **Drills made entirely by grinding** - they guarantee high precision and straightness of openings, with efficiency several times higher than for cylindrical or precision ground drills
- **Material** - high-grade high-speed steel, refined
- **Improved abrasion resistance** • **Improved resilience and torsional strength** • Packed and sold in a plastic tube, rectangular; dimensions 0.5 - 8.0 mm 10 pcs each; dimensions 8.1 - 13.0 mm 5 pcs. each; dimensions 13.5 - 20.0 mm 1 pc each

Code	Ø (mm)	Working part length (mm)	L total (mm)	
77005	0.5	6	22	10/200/1000
77008	0.8	10	30	10/200/1000
77010	1.0	12	34	10/200/1000
77011	1.1	14	36	10/200/1000
77012	1.2	16	38	10/200/1000
77013	1.3	16	38	10/200/1000
77015	1.5	18	40	10/200/1000
77016	1.6	20	43	10/200/1000
77018	1.8	22	46	10/200/1000
77019	1.9	22	46	10/200/1000
77020	2.0	24	49	10/200/1000
77021	2.1	24	49	10/200/1000
77022	2.2	27	53	10/200/1000
77023	2.3	27	53	10/200/1000
77024	2.4	30	57	10/200/1000
77025	2.5	30	57	10/200/1000
77026	2.6	30	57	10/200/1000
77027	2.7	33	61	10/200/1000
77028	2.8	33	61	10/200/1000
77029	2.9	33	61	10/200/1000
77030	3.0	33	61	10/200/1000
77031	3.1	36	65	10/200/1000
77032	3.2	36	65	10/200/1000
77033	3.3	36	65	10/200/1000
77034	3.4	39	70	10/200/1000
77035	3.5	39	70	10/200/1000
77036	3.6	39	70	10/250/500
77037	3.7	39	70	10/250/500
77038	3.8	43	75	10/250/500
77039	3.9	43	75	10/250/500
77040	4.0	43	75	10/250/1500
77041	4.1	43	75	10/250/500
77042	4.2	43	75	10/250/1500
77043	4.3	47	80	10/250/500
77044	4.4	47	80	10/250/500
77045	4.5	47	80	10/250/1500
77046	4.6	47	80	10/250/500
77047	4.7	47	80	10/250/500
77048	4.8	52	80	10/250/500
77049	4.9	52	86	10/250/500

Code	Ø (mm)	Working part length (mm)	L total (mm)	
77050	5.0	52	86	10/250/1500
77051	5.1	52	86	10/250/500
77052	5.2	52	86	10/250/500
77053	5.3	52	86	10/250/500
77054	5.4	57	93	10/250/500
77055	5.5	57	93	10/250/1500
77056	5.6	57	93	10/250/500
77057	5.7	57	93	10/250/500
77058	5.8	57	93	10/250/500
77059	5.9	57	93	10/250/500
77060	6.0	57	93	10/250/1500
77061	6.1	63	101	10/100/300
77062	6.2	63	101	10/100/300
77063	6.3	63	101	10/100/300
77064	6.4	63	101	10/100/300
77065	6.5	63	101	10/100/600
77066	6.6	63	101	10/100/300
77067	6.7	63	101	10/100/300
77068	6.8	69	109	10/100/600
77069	6.9	69	109	10/100/300
77070	7.0	69	109	10/100/600
77071	7.1	69	109	10/100/400
77072	7.2	69	109	10/100/400
77073	7.3	69	109	10/100/400
77074	7.4	69	109	10/100/400
77075	7.5	69	109	10/100/400
77076	7.6	75	117	10/100/400
77077	7.7	75	117	10/100/400
77078	7.8	75	117	10/100/400
77079	7.9	75	117	10/100/400
77080	8.0	75	117	10/100/400
77081	8.1	75	117	5/50/200
77082	8.2	75	117	5/50/200
77083	8.3	75	117	5/50/200
77084	8.4	75	117	5/50/200
77085	8.5	75	117	5/50/200
77086	8.6	81	125	5/50/200
77087	8.7	81	125	5/50/200
77088	8.8	81	125	5/50/200
77089	8.9	81	125	5/50/200
77090	9.0	81	125	5/50/200
77091	9.1	81	125	5/50/200
77092	9.2	81	125	5/50/200
77093	9.3	81	125	5/50/200
77094	9.4	81	125	5/50/200
77095	9.5	81	125	5/50/200
77096	9.6	87	133	5/50/200
77097	9.7	87	133	5/50/200
77098	9.8	87	133	5/50/200
77099	9.9	87	133	5/50/200
77100	10.0	87	133	5/50/200
77102	10.2	87	133	5/50/200
77105	10.5	87	133	5/50/200
77110	11.0	94	142	5/50/200
77115	11.5	94	142	5/50/200
77120	12.0	101	151	5/50/200
77125	12.5	101	151	5/50/200
77130	13.0	101	151	5/50/200
77135	13.5	108	160	100
77140	14.0	108	160	100
77145	14.5	114	169	50
77150	15.0	114	169	50
77155	15.5	120	178	50
77160	16.0	120	178	50
77165	16.5	125	184	50
77170	17.0	125	184	50
77175	17.5	130	191	50
77180	18.0	130	191	50
77185	18.5	135	198	50
77190	19.0	135	198	50
77195	19.5	140	205	50
77200	20.0	140	205	50

**2 HSS TWIST DRILL SETS**

• НАБОРЫ СВЕРЛ ПО МЕТАЛЛУ HSS • METALLBOHRER HSS



- **Nose angle 135° with chamfering adjustment** • **Drills made entirely by grinding** • **Material** - high-grade high-speed steel, refined, resistant to torsional stress

Code	Range (mm)	The quantity (pcs.)	
77213	1.5-6.5 every 0.5 + 3.2, 4.8	13	25/100
77214	2-8 every 0.5	13	10/50

**3 HSS TWIST DRILL SETS**

• НАБОРЫ СВЕРЛ ПО МЕТАЛЛУ HSS • METALLBOHRER HSS



- **Nose angle 135° with chamfering adjustment** • **Drills made entirely by grinding** • **Material** - high-grade high-speed steel, refined, resistant to torsional stress

Code	Range (mm)	The quantity (pcs.)	
77219	1-10 every 0.5	19	25
77225	1-13 every 0.5	25	10

PROLINE

LANTTI PRO

MEGA

JUCO

OTHER BRANDS

ERDI

KLINGSPOR

EXPRESS

ACTION CAN

TRYTON

VULCAN

### 1 HSS-CO JOBBER DRILLS

- СВЕРЛА ПО МЕТАЛЛУ ИЗ СТАЛИ HSS-CO С КОБАЛЬТОМ
- METALLBOHRER HSS-CO



- **Nose angle 135° with chamfering adjustment** - enables to make holes quickly, saving time when marking off
- Cobalt-coated (5% of cobalt)
- High temperature resistance
- For drilling in high-alloy, titanium, acid-resistant, stainless, high-temperature alloy steels and cast iron (resistance above 900 N/m<sup>2</sup>) and other materials difficult to machine
- **Drills entirely made by grinding** - guarantee high precision and straightness of openings
- Packed and sold in a plastic tube, rectangular, dimensions 0.5 - 8.0 mm 10 pcs each.; dimensions 8.1 - 13.0 mm 5 pcs. each; dimensions 14 - 20.0 mm 1 pc each

Code	Ø [mm]	Working part length [mm]	L total [mm]	
78005	0.5	6	22	10/200/1000
78008	0.8	10	30	10/200/1000
78010	1.0	12	34	10/200/1000
78015	1.5	18	40	10/200/1000
78020	2.0	24	49	10/200/1000
78022	2.2	27	53	10/200/1000
78025	2.5	30	57	10/200/1000
78030	3.0	33	61	10/200/1000
78031	3.1	36	65	10/200/1000
78032	3.2	36	65	10/200/1000
78035	3.5	39	70	10/200/1000
78038	3.8	43	75	10/250/500
78040	4.0	43	75	10/250/1500
78041	4.1	43	75	10/250/500
78042	4.2	43	75	10/250/1500
78045	4.5	47	80	10/250/1500
78048	4.8	52	86	10/250/500
78050	5.0	52	86	10/250/1500
78051	5.1	52	86	10/250/500
78052	5.2	52	86	10/250/500
78055	5.5	57	93	10/250/1500
78060	6.0	57	93	10/250/1500
78061	6.1	63	101	10/100/300
78062	6.2	63	101	10/100/300
78065	6.5	63	101	10/100/600
78070	7.0	69	109	10/100/600
78075	7.5	69	109	10/100/400
78080	8.0	75	117	10/100/400
78081	8.1	75	117	5/50/200
78082	8.2	75	117	5/50/200
78085	8.5	75	117	5/50/200
78090	9.0	81	125	5/50/200
78095	9.5	81	125	5/50/200
78100	10.0	87	133	5/50/200
78102	10.2	87	133	5/50/200
78105	10.5	87	133	5/50/200
78110	11.0	94	142	5/50/200
78115	11.5	94	142	5/50/200
78120	12.0	101	151	5/50/200
78125	12.5	101	151	5/50/200
78130	13.0	101	151	5/50/200
78140	14.0	108	160	100
78150	15.0	114	169	50
78160	16.0	120	178	50
78180	18.0	130	191	50
78200	20.0	140	205	50

### 2 HSS-TIN COATED TWIST DRILLS

- СВЕРЛА ПО МЕТАЛЛУ ИЗ СТАЛИ HSS-TIN С ТИТАНОВЫМ НАПЫЛЕНИЕМ
- METALLBOHRER HSS-TIN



- **Nose angle 135° with chamfering adjustment**
- Drills made entirely by grinding, coated with titanium nitride improving their lifecycle and the quality of opening finishes
- Packed - individual case: dimensions 1.0 - 3.0 mm, sold in the sets of 2 pcs

Code	Ø [mm]	Working part length [mm]	L total [mm]	
77810	1.0	12	34	2/200/600
77815	1.5	18	40	2/100/300
77820	2.0	24	49	2/100/300
77825	2.5	30	57	2/100/300
77830	3.0	33	61	2/200/600
77832	3.2	36	65	100/300
77835	3.5	39	70	100/300
77840	4.0	43	75	100/300
77842	4.2	43	75	100/300
77845	4.5	47	80	100/300
77848	4.8	52	86	100/300
77850	5.0	52	86	100/300
77852	5.2	57	86	50/200
77855	5.5	57	93	50/200
77860	6.0	63	93	50/200
77865	6.5	69	101	50/200
77870	7.0	69	109	50/100
77875	7.5	75	109	50/100
77880	8.0	75	117	50/100
77885	8.5	36	117	50/100
77890	9.0	81	125	50/100
77895	9.5	81	125	50/100
77900	10.0	87	133	50/100
77905	10.5	87	133	25/50
77910	11.0	94	142	25/50
77915	11.5	94	142	25/50
77920	12.0	101	151	25/50
77925	12.5	101	151	25/50
77930	13.0	101	151	25/50



### 3 HSS-CO TWIST DRILL SETS

- НАБОР СВЕРЛ ПО МЕТАЛЛУ HSS - METALLBOHRER HSS-CO



- **Nose angle 135° with chamfering adjustment**
- Drills made entirely by grinding
- Cobalt-coated (5% of cobalt)

Code	Range [mm]	The quantity [pcs.]	
78219	1-10 every 0.5	19	25
78225	1-13 every 0.5	25	10

### 4 HSS-TIN COATED TWIST DRILL SET

- НАБОР СВЕРЛ ПО МЕТАЛЛУ HSS - METALLBOHRER HSS-TIN



- **Nose angle 135° with chamfering adjustment**
- Drills made entirely by grinding, coated with titanium nitride improving their lifecycle and the quality of opening finishes, enabling to apply higher machining parameters
- Packed - individual case: dimensions 1.0 - 3.0 mm, sold in the sets of 2 pcs

Code	Range [mm]	The quantity [pcs.]	
77990	1-10 co 0.5	19	25

**1 HSS STUBBY DRILLS**

• КОРОТКИЕ СВЕРЛА ПО МЕТАЛЛУ ИЗ СТАЛИ HSS • METALLBOHRER HSS KURZ



- **Nose angle 135° with chamfering adjustment** enabling to make holes quickly, saving time when punching
- **Drills entirely made by grinding** - guarantee high precision and straightness of openings
- Sold in a rectangular plastic tube: 1.0 - 8.0 mm 10 pcs. each; 8.5 - 13.0 mm 5 pcs. each; 16.0 - 18.0 mm 1 pcs.

Code	Ø (mm)	Working part length (mm)	Total length (mm)	
78410	1.0	6	26	10/200/600
78415	1.5	9	32	10/200/1000
78420	2.0	12	38	10/200/1000
78425	2.5	14	43	10/200/1000
78430	3.0	16	46	10/200/1000
78431	3.1	18	49	10/200/1000
78432	3.2	18	49	10/200/1000
78433	3.3	18	49	10/200/1000
78435	3.5	20	52	10/200/1000
78440	4.0	22	55	10/250/1500
78441	4.1	22	55	10/250/1500
78442	4.2	22	55	10/250/1500
78443	4.3	24	58	10/250/1500
78445	4.5	24	58	10/250/1500
78448	4.8	26	62	10/250/500
78450	5.0	26	62	10/250/500
78451	5.1	26	62	10/250/500
78452	5.2	26	62	10/250/1500
78453	5.3	26	62	10/250/1500
78455	5.5	28	66	10/250/1500
78457	5.7	28	66	10/250/1500
78458	5.8	28	66	10/250/500
78459	5.9	28	66	10/250/1500
78460	6.0	28	66	10/250/1500
78461	6.1	31	70	10/100/300
78462	6.2	31	70	10/100/300
78463	6.3	31	70	10/100/600
78465	6.5	31	70	10/100/600
78467	6.7	31	70	10/100/600
78475	7.5	34	74	10/100/400
78480	8.0	37	79	10/100/400
78485	8.5	37	79	5/50/200
78490	9.0	40	84	5/50/200
78495	9.5	40	84	5/50/200
78500	10.0	43	89	5/50/200
78502	10.2	43	89	5/50/200
78511	11.0	47	95	5/50/200
78512	12.0	51	102	5/50/200
78513	13.0	51	102	5/50/200
78516	16.0	58	115	25/125
78518	18.0	62	123	25/125

**2 HSS LONG DRILLS**

• ДЛИННЫЕ СВЕРЛА ПО МЕТАЛЛУ ИЗ СТАЛИ HSS • METALLBOHRER LANG HSS

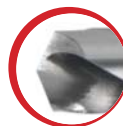

- **Nose angle 135° with chamfering adjustment** • Drills made entirely by grinding - guarantee high accuracy and straightness, especially useful when drilling through drill sleeves
- Long drill bits made by grinding are used for drilling in steel, non-ferrous metals and plastics
- **Material** - high-grade high-speed steel, refined
- Sold in a rectangular plastic tube: 0.8 - 8.0 mm po 10 pcs.; 8.2 - 12.0 mm po 5 pcs.; 14.0 - 20.0 mm po 1 pcs.

Code	Ø (mm)	Working part length (mm)	Total length (mm)	
77408	0.8	20	40	10/200/1000
77410	1.0	33	56	10/200/1000
77412	1.2	41	65	10/200/1000
77415	1.5	45	70	10/200/1000
77420	2.0	56	86	10/100/600
77421	2.1	56	86	10/100/600
77422	2.2	59	90	10/100/600
77425	2.5	62	95	10/100/600
77430	3.0	66	100	10/100/600
77431	3.1	69	106	10/100/600
77432	3.2	69	106	10/100/600
77435	3.5	73	112	10/100/600
77438	3.8	78	119	10/100/400
77440	4.0	78	119	10/100/400
77441	4.1	78	119	10/100/400
77442	4.2	78	119	10/100/400
77445	4.5	82	126	10/100/400
77448	4.8	87	132	10/100/400
77450	5.0	87	132	10/100/400
77451	5.1	87	132	10/100/400
77452	5.2	87	132	10/100/400
77455	5.5	91	139	10/100/400
77460	6.0	91	139	10/100/400
77461	6.1	97	148	10/100/400
77462	6.2	97	148	10/100/400
77465	6.5	97	148	10/100/400
77470	7.0	102	156	10/100/400
77475	7.5	102	156	10/100/400
77480	8.0	109	165	10/100
77482	8.2	109	165	5/100
77485	8.5	109	165	5/100
77490	9.0	115	175	5/100
77495	9.5	115	175	5/100
77500	10.0	121	184	5/100
77502	10.2	121	184	5/100
77505	10.5	121	184	5/100
77511	11.0	128	195	5/100
77512	12.0	134	205	5/100
77514	14.0	140	214	50
77515	15.0	144	200	100
77516	16.0	149	227	50
77517	17.0	154	235	100
77518	18.0	158	241	50
77520	20.0	166	254	50

**3 HSS DOUBLE ENDED DRILLS**

• ДВУХСТОРОННИЕ СВЕРЛА ПО МЕТАЛЛУ ИЗ СТАЛИ HSS • METALLBOHRER HSS, DOPPELSEITIG



- **Ground** • **Nose angle 135° with chamfering adjustment**
- Sold in a rectangular plastic tube, 10 pcs each

Code	Ø (mm)	Total length (mm)	
78630	3.0	49	10/200/600
78631	3.1	49	10/200/600
78632	3.2	49	10/200/600
78633	3.3	49	10/200/600
78635	3.5	52	10/200/1000
78640	4.0	55	10/250/1500
78641	4.1	55	10/250/500
78642	4.2	55	10/250/1500
78645	4.5	55	10/250/1500
78650	5.0	62	10/250/1500
78651	5.1	62	10/250/500
78652	5.2	62	10/250/500

**1 FRAMEWORK DRILLS**

• СВЕРЛА ДЛЯ ОПАЛУБКИ • FACHWERKBOHRER



• Length 400 and 600 mm



Code	Ø (mm)	Length (mm)	☐	☐
76410	10	400	x	20/100
76412	12	400	x	20/100
76414	14	400	x	20/100
76416	16	400	x	20/100
76418	18	400	x	10/50
76420	20	400	x	10/50
76610	10	600	x	20/100
76612	12	600	x	20/100
76614	14	600	x	20/100
76616	16	600	x	20/100
76618	18	600	x	10/50
76620	20	600	x	10/50



PROLINE

LAHTI PRO

MEGA

JUCO

OTHER BRANDS

ERDI

KLINGSPOR

EXPRESS

ACTION CAN



TRYTON



VULCAN



# PROLINE DRILL BITS FOR CONCRETE

Description	Characteristics	Head
-------------	-----------------	------

<p><b>MASONRY DRILL BITS</b> Straight shank</p>	<p><b>STRAIGHT SHANK DRILL BITS FOR MASONRY AND BRICKS</b></p> <ul style="list-style-type: none"> <li>• Basic hammer drill bits for all masonry work.</li> <li>• Drill bit with a rolled flute with cemented carbide tip.</li> </ul> <p><b>For use in building materials used in masonry walls:</b> silicate brick, brick, cement-lime blocks.</p> <p><b>Use:</b> hammer drills</p> <p><b>Drill bit diameters: from 3 mm to 16 mm</b></p>	
---	---	--







<p><b>SDS PLUS S2 DRILL BITS FOR CONCRETE</b></p> 	<p><b>DRILL BITS FOR NON-REINFORCED CONCRETE WITH A DOUBLE FLUTE AND SDS PLUS SHANK</b></p> <ul style="list-style-type: none"> <li>• Tungsten carbide tipped (TCT) edge with enlarged centering tip that allows drilling without walking</li> <li>• Double flute dampens vibrations and increases drill-bit strength</li> <li>• Quick removal of cuttings from the hole</li> </ul> <p><b>For use in building materials:</b> non-reinforced concrete, natural stone, masonry, brick</p> <p><b>Drill diameters: from 4 mm to 28 mm.</b></p>	
---	---	--

<p><b>SDS PLUS S4 DRILL BITS FOR CONCRETE</b></p> 	<p><b>DRILL BITS FOR REINFORCED CONCRETE WITH DOUBLE FLUTE, WITH S4 EDGE AND SDS PLUS SHANK</b></p> <ul style="list-style-type: none"> <li>• Enables effective drilling in reinforced concrete (does not stop in contact with reinforcement), is 3 times more effective than a standard SDS-Plus drill bit</li> <li>• Tip with with four S4 edges enables accurate and reliable drill bit guiding</li> <li>• High dimensional tolerance for obtained holes</li> <li>• Tungsten carbide tip (TCT) with enlarged centering tip that allows drilling without walking</li> <li>• Double flute dampens vibrations and increases drill-bit strength</li> </ul> <p><b>For use in building materials:</b> non-reinforced concrete, natural stone, masonry, brick</p> <p><b>Drill diameters: from 4 mm to 28 mm.</b></p>	
---	---	--

<p><b>SDS MAX S4 DRILL BITS FOR CONCRETE</b></p> 	<p><b>DRILL BITS FOR REINFORCED CONCRETE WITH DOUBLE FLUTE, WITH S4 EDGE AND SDS MAX SHANK</b></p> <ul style="list-style-type: none"> <li>• Enables effective drilling in reinforced concrete (does not stop in contact with reinforcement)</li> <li>• S4 tip with four edges enables accurate and reliable drill bit guiding.</li> <li>• High dimensional tolerance for obtained holes</li> <li>• Tungsten carbide tipped (TCT) edge with enlarged centering tip that allows drilling without slips</li> <li>• Double flute dampens vibrations and increases drill-bit strength</li> <li>• Increased effectiveness and strength in comparison with SDS Plus concrete drill bits.</li> </ul> <p><b>For use in building materials:</b> reinforced concrete, natural stone, brick, masonry, clinker brick, granite, marble and other natural stones</p> <p><b>Drill bit diameters: from 16 mm to 40 mm</b></p>	
--	--	--

- PROLINE
- LAHTI PRO
- MEGA
- JUICO
- OTHER BRANDS
- ENDI
- KLINGSPOR
- EXPRESS
- ACTION CAN
- TRAYTON
- VULCAN

# СВЕРЛА ПО БЕТОНУ PROLINE

Описание	Характеристики	Головка
<p><b>СВЕРЛА ПО БЕТОНУ</b> <b>Прямой хвостовик</b></p>	<p><b>СВЕРЛА С ПРЯМЫМ ХВОСТОВИКОМ ПО БЕТОНУ И КИРПИЧУ</b></p> <ul style="list-style-type: none"> <li>Стандартные перфораторные буры для всех работ по бетону.</li> <li>Бур с прокатанной канавкой и твердосплавным наконечником.</li> </ul> <p><b>Используется в строительных материалах кладки:</b> силикатный кирпич, кирпич, цементно-известковые блоки.</p> <p><b>Применение:</b> перфораторы <b>Диаметр сверла:</b> от 3 до 16 мм</p>	
<p><b>СВЕРЛА ПО БЕТОНУ SDS PLUS S2</b></p> 	<p><b>СВЕРЛА ДЛЯ НЕАРМИРОВАННОГО БЕТОНА С ДВОЙНОЙ КАНАВКОЙ И ХВОСТОВИКОМ SDS PLUS</b></p> <ul style="list-style-type: none"> <li>Режущая пластина из карбида вольфрама (ТСТ) с увеличенным центрирующим наконечником, позволяющим сверлить без вибрации</li> <li>Двойная канавка гасит вибрации и увеличивает прочность бура</li> <li>Быстрое удаление отходов из отверстия</li> </ul> <p><b>Для использования в строительных материалах:</b> неармированный бетон, природный камень, кладка, кирпич</p> <p><b>Диаметр сверла:</b> от 4 до 28 мм.</p>	
<p><b>СВЕРЛА ПО БЕТОНУ SDS PLUS S4</b></p> 	<p><b>СВЕРЛА ДЛЯ НЕАРМИРОВАННОГО БЕТОНА С ДВОЙНОЙ КАНАВКОЙ, КРОМКОЙ S4 И ХВОСТОВИКОМ SDS PLUS</b></p> <ul style="list-style-type: none"> <li>Обеспечивает эффективное сверление в железобетоне (не останавливается при контакте с арматурой), в 3 раза эффективнее, чем стандартное сверло SDS-Plus</li> <li>Наконечник с четырьмя кромками S4 точно и надежно направляет сверло</li> <li>Высокий размерный допуск для полученных отверстий</li> <li>Режущая пластина из карбида вольфрама (ТСТ) с увеличенным центрирующим наконечником, позволяющим сверлить без вибрации</li> <li>Двойная канавка гасит вибрации и увеличивает прочность бура</li> </ul> <p><b>Для использования в строительных материалах:</b> неармированный бетон, природный камень, кладка, кирпич</p> <p><b>Диаметр сверла:</b> от 4 до 28 мм.</p>	
<p><b>СВЕРЛА ПО БЕТОНУ SDS MAX S4</b></p> 	<p><b>СВЕРЛА ДЛЯ НЕАРМИРОВАННОГО БЕТОНА С ДВОЙНОЙ КАНАВКОЙ, КРОМКОЙ S4 И ХВОСТОВИКОМ SDS MAX</b></p> <ul style="list-style-type: none"> <li>Обеспечивает эффективное сверление в железобетоне (не останавливается при контакте с арматурой)</li> <li>Наконечник с четырьмя кромками S4 точно и надежно направляет сверло.</li> <li>Высокий размерный допуск для полученных отверстий</li> <li>Режущая пластина из карбида вольфрама (ТСТ) с увеличенным центрирующим наконечником, позволяющим сверлить без вибрации</li> <li>Двойная канавка гасит вибрации и увеличивает прочность бура</li> <li>Более высокая эффективность и прочность по сравнению со сверлами по бетону SDS Plus.</li> </ul> <p><b>Для использования в строительных материалах:</b> железобетон, природный камень, кирпич, кладка, клинкерный кирпич, гранит, мрамор и другие природные камни</p> <p><b>Диаметр сверла:</b> от 16 до 40 мм</p>	

# PROLINE BOHRER FÜR BETON

Beschreibung	Eigenschaften	Kopf
<b>BOHRER FÜR MAUERWERK</b> <b>Gerader Schaft</b>	<b>BOHRER FÜR MAUERWERK UND ZIEGEL MIT GERADEM SCHAFT</b> <ul style="list-style-type: none"> <li>• Standardbohrhammerbohrer für alle Mauerwerkerarbeiten.</li> <li>• Bohrer mit gerollter Nut mit Hartmetallspitze.</li> </ul> <b>Zur Verwendung in Mauerwerk verwendeten Baustoffen:</b> Silikatziegel, Ziegel, Zement-Kalkblöcke. <b>Verwendung:</b> Bohrhammerbohrer <b>Bohrerdurchmesser: von 3 mm bis 16 mm</b>	  
<b>SDS PLUS S2 BOHRER FÜR BETON</b> 	<b>BOHRER FÜR UNBEWEHRTEN BETON MIT DOPPELTER NUT UND SDS PLUS SCHAFT</b> <ul style="list-style-type: none"> <li>• Tungsten-Carbide-Tipped (TCT) behandelte Kante mit ausgeweiteter Zentrierungsspitze, die ein stabile Bohrung sicherstellt</li> <li>• Die doppelte Nut dämpft Vibrationen und steigert die Festigkeit des Bohrereinsatzes</li> <li>• Schnelles Entfernen der Späne aus dem Bohrloch</li> </ul> <b>Zur Verwendung in folgendem Baumaterial:</b> unbewehrter Beton, Naturstein, Mauerwerk, Ziegel <b>Bohrerdurchmesser: von 4 mm bis 28 mm</b>	   
<b>SDS PLUS S4 BOHRER FÜR BETON</b> 	<b>BOHRER FÜR BEWEHRTEN BETON MIT DOPPELTER NUT, S4 KANTE UND SDS PLUS SCHAFT</b> <ul style="list-style-type: none"> <li>• Ermöglicht effektives Bohren in bewehrtem Beton (kein Stoppen bei Kontakt mit Bewehrung), der Bohrer ist 3 Mal so effektiv wie ein standardmäßiger SDS-Plus-Bohrer.</li> <li>• Die Spitze mit vier S4 Kanten ermöglicht die genaue und zuverlässige Bohrerführung.</li> <li>• Hohe Maßtoleranz für erhaltene Bohrlöcher.</li> <li>• Tungsten-Carbide-Spitze (TCT) mit ausgeweiteter Zentrierungsspitze, die ein stabile Bohrung sicherstellt.</li> <li>• Die doppelte Nut dämpft Vibrationen und steigert die Festigkeit des Bohrereinsatzes.</li> </ul> <b>Zur Verwendung in folgendem Baumaterial:</b> unbewehrter Beton, Naturstein, Mauerwerk, Ziegel <b>Bohrerdurchmesser: von 4 mm bis 28 mm</b>	   
<b>SDS MAX S4 BOHRER FÜR BETON</b> 	<b>BOHRER FÜR BEWEHRTEN BETON MIT DOPPELTER NUT, S4 KANTE UND SDS MAX SCHAFT</b> <ul style="list-style-type: none"> <li>• Ermöglicht effektives Bohren in bewehrtem Beton (kein Stoppen bei Kontakt mit Bewehrung).</li> <li>• Die S4 Spitze mit vier Kanten ermöglicht die genaue und zuverlässige Bohrerführung.</li> <li>• Hohe Maßtoleranz für erhaltene Bohrlöcher.</li> <li>• Tungsten-Carbide-Tipped (TCT) behandelte Kante mit ausgeweiteter Zentrierungsspitze, die Bohrung ohne Verrutschen sicherstellt.</li> <li>• Die doppelte Nut dämpft Vibrationen und steigert die Festigkeit des Bohrereinsatzes.</li> <li>• Höhere Effizienz und Festigkeit im Vergleich zu SDS Plus Bohren für Beton.</li> </ul> <b>Zur Verwendung in folgendem Baumaterial:</b> unbewehrter Beton, Naturstein, Ziegel, Mauerwerk, Klinker, Granit, Marmor und andere Natursteine <b>Bohrerdurchmesser: von 16 mm bis 40 mm</b>	   

**1 MASONRY DRILLS**

• СВЕРЛА ПО БЕТОНУ • BETONBOHRER



- Drills for general masonry work
- Have rolled flutes and a sintered carbide edge, which allows quick drilling in soft building materials
- Supplied in a plastic case

Code	Ø (mm)	Total length (mm)		
73103	3	60	x	50/300
73104	4	75	x	50/300
73105	5	85	x	50/300
73106	6	100	x	50/200
73108	8	120	x	50/200
73109	9	120	x	50/200
73110	10	120	x	50/200
73112	12	150	x	50/200
73206	6	200	x	50/100
73208	8	200	x	50/100
73210	10	200	x	50/100
73212	12	200	x	50/100
73214	14	200	x	25/50
73216	16	200	x	25/50
73306	6	300	x	50/100
73308	8	300	x	50/100
73310	10	300	x	50/100
73312	12	300	x	50/100
73408	8	400	x	25/50
73410	10	400	x	25/50
73412	12	400	x	25/50
73414	14	400	x	25/50
73416	16	400	x	25/50
73608	8	600	x	25/50
73610	10	600	x	25/50
73612	12	600	x	25/50
73614	14	600	x	25/50

**2 MASONRY DRILL SET**

• НАБОРЫ СВЕРЛ ПО БЕТОНУ • BETONBOHRER



- Packed in a plastic box, making a base when opened

Code	Dimensions (mm)	The quantity (pcs.)	
73703	6, 8, 10	3	25/100
73705	4, 5, 6, 8, 10	5	25/100
73708	3, 4, 5, 6, 7, 8, 9, 10	8	10/50



PROLINE

LAHTI PRO

MEGA

JUCO

OTHER BRANDS

ERDI

KLINGSPOR

EXPRESS

ACTION CAN

TRYTON

VULCAN





PROLINE

LAHTI PRO

MEGA

JUCO

OTHER BRANDS

ERDI

KLINGSPOR

EXPRESS

ACTION CAN

TRYTON

VULCAN

**1 SDS MAX S4 CROSS HEAD DRILLS FOR CONCRETE**

- СВЕРЛА ПО БЕТОНУ SDS MAX ТИП S4
- BETONBOHRER SDS MAX S4



- Drills for industrial and professional applications
- For drilling in concrete and granite
- Double twist ensures quick dust release
- 4-blade insert with optimised geometry

Code	Ø (mm)	Total length (mm)		
71634	16	340	x	5/50
71654	16	540	x	10/40
71692	16	920	x	5/20
71834	18	340	x	5/50
71854	18	540	x	10/40
71892	18	920	x	5/20
72232	22	320	x	10/50
72252	22	520	x	10/30
72272	22	720	x	10/30
72292	22	920	x	5/15
72432	24	320	x	10/50
72452	24	520	x	10/20
72532	25	320	x	10/30
72552	25	520	x	10/20
72572	25	720	x	10/20
72592	25	920	x	5/10
72652	26	520	x	10/20
72837	28	370	x	5/25
72857	28	570	x	3/15
72867	28	670	x	5/10
72892	28	920	x	3/12
73037	30	370	x	5/20
73057	30	570	x	3/15
73072	30	720	x	5/10
73092	30	920	x	2/10
73237	32	370	x	5/25
73257	32	570	x	2/10
73272	32	720	x	5/10
73292	32	920	x	2/10
73537	35	370	x	5/20
73557	35	570	x	2/10
73567	35	670	x	5/10
73572	35	720	x	5/10
73592	35	920	x	2/6
74037	40	370	x	5/25
74057	40	570	x	3/15
74072	40	720	x	5/10
74092	40	920	x	2/6



**2 SDS MAX GOUGE CHISEL**

- ДОЛОТО (ШТРОБНИК) SDS MAX
- BETONMEISSEL SDS MAX



- Chisel 25 mm

Code	Dimensions (mm)	Width (mm)		
81720	18 x 300	25	x	10/50

**3 SDS MAX CHISELS**

- ПИКИ И ЗУБИЛА SDS MAX
- BETONMEISSEL SDS MAX



Code	Size (mm)	Width (mm)		
• pointed				
81710	18 x 280	-	x	10/50
81711	18 x 400	-	x	10/20
81712	18 x 600	-	x	5/20
• flat				
81713	18 x 280	25	x	10/50
81714	18 x 400	25	x	10/20
81715	18 x 600	25	x	5/20
• wide				
81716	18 x 280	50	x	5/35
81717	18 x 400	50	x	5/25
81718	18 x 600	50	x	5/20
81719	18 x 300	75	x	5/25

**4 SDS MAX BUTTERFLY CHISEL**

- КРЫЛЬЧАТОЕ ДОЛОТО SDS MAX • SDS MAX SCHMETTERLINGS-MEISSEL



- Designed for brick, cellular concrete
- Wings ensure stable chisel guiding

Code	Size (mm)	Width (mm)		
81722	18 x 380	23	x	5/25

**5 SDS PLUS POINT CHISEL**

- ПРОБОЙНИК ПО БЕТОНУ SDS PLUS
- BETONNOCHEISEN SDS PLUS



Code	Size (mm)	
81730	17 x 250	25/50

**6 SDS PLUS FLAT CHISELS**

- ПИКИ И ЗУБИЛА SDS PLUS • BETONNOCHEISEN SDS PLUS



Code	Size (mm)	Width (mm)		
• flat				
81733	17 x 250	20	x	25/50
• wide				
81731	17 x 250	40	x	25/50

**7 SDS PLUS GROOVE CHISEL**

- ШТРОБОРЕЗ РУЧНОЙ ДЛЯ БЕТОНА (БОРОЗДОДЕЛ) SDS PLUS
- BETONKANALMEISSEL SDS PLUS



Code	Size (mm)	Width (mm)		
81732	17 x 250	23	x	25/50

**8 SDS PLUS CHUCK ADAPTOR**







- ПЕРЕХОДНИК - АДАПТЕР SDS PLUS
- ADAPTER SDS PLUS



- Thread 1/2" • SDS plus chuck with a counter bolt

Code		
81724	x	25/200

# PROLINE DRILL BITS FOR WOOD

Description	Characteristics	Shank	Head
<b>DRILL BITS FOR WOOD WITH SPIRAL FLUTE, STRAIGHT SHANK</b>	A special shape of the chip evacuating flute, which begins with a special spike, facilitating comfortable drilling in the desired direction. <b>For holes with diameters from 3 to 12 mm and a depth of approx. 100 to 150 mm</b>	STRAIGHT	 
<b>WOOD SPADE BITS, HEX SHANK</b>	The cutting part is flattened and has two straight, sharpened cutting edges. <b>Spade diameters range from 6 to 45 mm</b> , while a hex shank allows secure fixing in the drill chuck	HEX	 
<b>SPECIAL WOOD DRILL BITS (AUGERS), HEX SHANK</b>	These drill bits have a single-spiral flute with one land. A single flute in a drill bit with such a shape is large and allows easy removal of chips from the drilled hole. The working part is finished with spurs, a cutter and guide bit with a conical thread. The drill bit is made of high-grade alloyed tool steel, with a ground margin edge. <b>Augers are used to make deep holes in wood in a wide range of diameters, between 6-40 mm and to a depth of 200-400 mm.</b>	HEX	 



# СВЕРЛА ПО ДЕРЕВУ PROLINE

Описание	Характеристики	Хвостовик	Головка
<p><b>СВЕРЛА ПО ДЕРЕВУ СО СПИРАЛЬНОЙ КАНАВКОЙ И ПРЯМЫМ ХВОСТОВИКОМ</b></p>	<p>Специальная форма канавки для удаления стружки, которая начинается со специального выступа для комфортного сверления в нужном направлении. <b>Для отверстий диаметром от 3 до 12 мм и глубиной от 100 до 150 мм</b></p>	ПРЯМОЙ	
<p><b>СВЕРЛА ЛОПАТОЧНЫЕ ПО ДЕРЕВУ С ШЕСТИГРАННЫМ ДЕРЖАТЕЛЕМ (GRIP)</b></p>	<p>Режущая часть сплющена и имеет две прямые заточенные режущие кромки. <b>Диаметр лезвия в диапазоне от 6 до 45 мм</b>, а шестигранный хвостовик гарантирует надежное крепление в сверлильном патроне</p>	ШЕСТИГРАННЫЙ	
<p><b>СПЕЦИАЛЬНЫЕ СВЕРЛА ПО ДЕРЕВУ (СПИРАЛЬНЫЕ СВЕРЛА) С ШЕСТИГРАННЫМ ХВОСТОВИКОМ</b></p>	<p>Эти сверла имеют односпиральную канавку с одной ленточкой. Одна канавка в сверле такой формы имеет большой размер и позволяет легко удалять стружку из просверленного отверстия. Рабочая часть оснащена выступами, резцом и направляющим наконечником с конической резьбой. Сверло изготовлено из высоколегированной инструментальной стали со шлифованной кромкой. <b>Спиральные сверла используются для проделывания глубоких отверстий в дереве диаметром от 6-40 мм и на глубину до 200-400 мм.</b></p>	ШЕСТИГРАННЫЙ	



PROLINE

LANITI PRO

MEGA

JUCO

OTHER BRANDS

ERDI

KUNGSFOR







EXPRESS

ACTION CAN

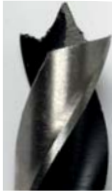
TRYTON

VULCAN

# PROLINE BOHRER FÜR HOLZ

Beschreibung	Eigenschaften	Schaft	Kopf
<b>BOHRER FÜR HOLZ MIT SPIRALSENKER, GERADER SCHAFT</b>	Die spezielle Form der Nut zur Abbeförderung von Spänen, die mit einem speziellen Spitze beginnt, erleichtert das komfortable Bohren in die gewünschte Richtung. <b>Für Bohrlöcher mit einem Durchmesser von 3 bis 12 mm und einer Tiefe von ca. 100 bis 150 mm.</b>	GERADE	 
<b>FLACHFRÄSBOHRER FÜR HOLZ, SECHSKANTSCHAFT</b>	Das Schneidteil ist abgeflacht und hat zwei gerade, geschärfte Schneidkanten. <b>Durchmesser der Flachfräser von 6 bis 45 mm</b> , während der Sechskantschaft eine sichere Befestigung des Bohrfutters ermöglicht.	HEX	 
<b>SPEZIALBOHRER FÜR HOLZ (SCHLANGENBOHRER), SECHSKANTSCHAFT</b>	Diese Bohrfutter haben eine einspiralige Nut mit einem Schneidteil. Eine einzelne Nut in einem Bohrfutter mit dieser Form ist groß und ermöglicht die einfache Abbeförderung von Spänen durch das Bohrloch. Das Arbeitsteil ist mit Sporen, einem Fräser und einem Führungsbohrer mit konischem Gewinde versehen. Der Bohrer besteht aus hochwertigem legiertem Werkzeugstahl mit geschliffener Randkante. <b>Schlangenbohrer werden verwendet, um tiefe Bohrungen in Holz mit einem Durchmesser von 6-40 mm und einer Tiefe von 200-400 mm anzufertigen.</b>	HEX	 



PROLINE

LANITI PRO

MEGA

JUCO

OTHER BRANDS

ERDI

KUNGSFOR

EXPRESS

ACTION CAN

TRAYTON

VULCAN

### 1 WOOD DRILLS

• СВЕРЛА ПО ДЕРЕВУ • HOLZBOHRER



- High-quality tool alloy steel
- Delivered in plastic case

Code	Ø (mm)		
26273	3.0	x	50/300
26274	4.0	x	50/300
26275	5.0	x	50/300
26276	6.0	x	50/200
26277	7.0	x	50/200
26278	8.0	x	50/200
26279	9.0	x	50/200
26280	10.0	x	50/200
26282	12.0	x	50/200

### 2 WOOD DRILL SETS

• НАБОРЫ СВЕРЛ ПО ДЕРЕВУ • HOLZBOHRER



- High-quality tool alloy steel
- In a plastic box, being a base when open

Code	Dimensions (mm)	The quantity (pcs.)	
26295	4, 5, 6, 8, 10	5	25/100
26298	3, 4, 5, 6, 7, 8, 9, 10	8	10/50

### 3 BORING BIT 35MM

• СВЕРЛО ЦИЛИНДРИЧЕСКОЕ 35 ММ ПО ДЕРЕВУ  
• KUNSTBOHRER 35 MM FÜR HOLZ



Ø 35mm

2 EDGES

HRC 20±2

- Made from high-grade steel
- For drilling holes for furniture hinges
- Rolled shank 8 mm
- Two cutting edges improving drilling performance

Code	Ø (mm)	Total length (mm)		
31398	35	8 walcowy	x	120

### 4 AUGERS FOR WOOD

• СПИРАЛЬНЫЕ СВЕРЛА ПО ДЕРЕВУ • SCHLANGENBOHRER



- Threaded guiding blade
- For drilling in soft and hard wood as well as in laminated components
- Hexagonal handle
- Delivered in plastic case

Code	Ø (mm)	Total length (mm)		
26806	6	230	x	50/200
26808	8	230	x	50/200
26810	10	230	x	50/200
26812	12	230	x	50/200
26814	14	230	x	25/100
26816	16	230	x	25/100
26818	18	230	x	25/100
26820	20	230	x	25/100
26822	22	230	x	25/50
26824	24	230	x	25/50
26825	25	230	x	20/40
26826	26	230	x	20/40
26828	28	230	x	20/40
26830	30	230	x	20/40
26835	35	230	x	10/20
26840	40	230	x	10/20
26910	10	460	x	50/100
26912	12	460	x	50/100
26914	14	460	x	25/50
26916	16	460	x	25/50
26918	18	460	x	25/50
26920	20	460	x	25/50
26922	22	460	x	10/20
26924	24	460	x	10/20
26925	25	460	x	10/20
26926	26	460	x	10/20
26928	28	460	x	10/20
26930	30	460	x	10/20
26935	35	460	x	5/10
26940	40	460	x	5/10

### 5 DRILLS FOR GLASS

• СВЕРЛА ПО СТЕКЛУ И КЕРАМИКЕ • GLASBOHRER



WET DRILLING

YG-6X

- Blade made from tungsten carbide YG-6X
- Application: wet drilling in glass and soft ceramic products
- Roller shank

Code	Ø (mm)	Total length (mm)		
81903	3	65	x	100/400
81904	4	65	x	100/400
81905	5	68	x	100/400
81906	6	72	x	100/400
81908	8	80	x	100/400
81910	10	90	x	50/200

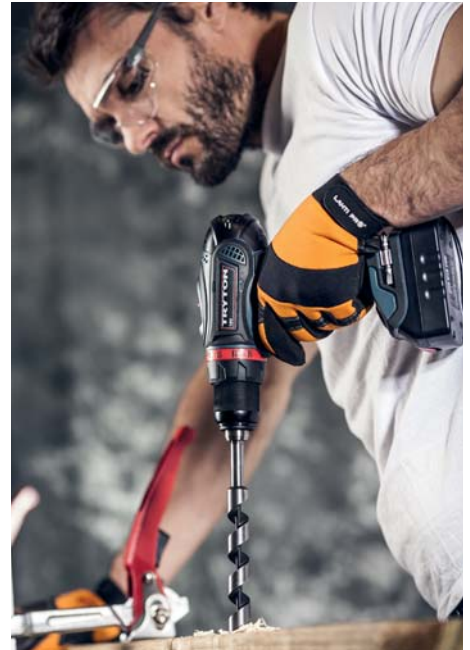

### 6 SPADE DRILLS

• ПЛОСКИЕ СВЕРЛА ПО ДЕРЕВУ • FLACHFRÄSBOHRER



- Tip and blade ground to ensure precision centering
- Perfect drills for making openings in wood, wood products and MDF boards
- Hexagonal handle
- Delivered in plastic case

Code	Ø (mm)	Total length (mm)		
26606	6	150	x	100/400
26608	8	150	x	100/400
26610	10	150	x	100/400
26612	12	150	x	100/400
26613	13	150	x	100/400
26614	14	150	x	100/400
26616	16	150	x	100/400
26618	18	150	x	100/400
26620	20	150	x	100/400
26622	22	150	x	50/200
26624	24	150	x	50/200
26625	25	150	x	50/200
26626	26	150	x	50/200
26628	28	150	x	50/200
26630	30	150	x	50/200
26632	32	150	x	50/200
26634	34	150	x	50/200
26635	35	150	x	50/200
26636	36	150	x	50/200
26638	38	150	x	50/200
26640	40	150	x	50/200
26645	45	150	x	50/200

### 7 EXTENSION BARS FOR FLAT WOOD DRILLS

• УДЛИНИТЕЛИ ДЛЯ ПЛОСКИХ СВЕРЛ ПО ДЕРЕВУ  
• VERLÄNGERUNGEN FÜR FLACHFRÄSBOHRER



- High-quality tool alloy steel
- In a plastic box, being a base when open

Code	Dimensions (mm)		
26691	150	x	50/100
26693	300	x	50

**1 BI-METAL HOLE SAWS**

- СВЕРЛА КОРОНЧАТЫЕ БИМЕТАЛЛИЧЕСКИЕ
- LOCHSÄGEN BIMETALL, HSS

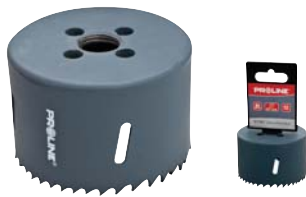

Ø 14,0-140,0 mm BI-METAL HSS

- Bi-metal hole saws are made from high-speed tool steel HSS • With a chuck to install adapter for hexagonal or SDS-plus socket
- Designed for machining metals, especially aluminium and steel, as well as stainless steel, nonferrous metals, plastic and wood • Need adapter and centering drill • Steel drilling should be made when wet • Alternate number of teeth 4/GTPI • Drilling depth 38 mm

Code	Ø [mm]		
27114	14	x	25/200
27116	16	x	25/200
27119	19	x	25/200
27120	20	x	25/200
27122	22	x	25/200
27124	24	x	25/200
27125	25	x	25/200
27127	27	x	25/200
27129	29	x	25/200
27130	30	x	25/200
27132	32	x	25/100
27135	35	x	25/100
27138	38	x	25/100
27140	40	x	25/100
27144	44	x	25/100
27146	46	x	25/100
27148	48	x	25/100
27151	51	x	25/100
27154	54	x	25/100
27157	57	x	25/100
27160	60	x	10/50
27164	64	x	10/50
27167	67	x	10/50
27168	68	x	10/50
27170	70	x	10/50
27173	73	x	10/50
27183	83	x	10/50
27192	92	x	10/50
27195	95	x	2/50
28102	102	x	2/20
28105	105	x	2/20
28121	121	x	2/20
28127	127	x	2/20
28140	140	x	2/10

**2 DRILL WITH COUNTERSINK 7 MM**

- КОМБИНИРОВАННОЕ СВЕРЛО СО СНЯТИЕМ ФАСКИ 7 MM
- BOHRSENKER 7 MM



PLASTIC WOOD Ø 7mm Ø3.5mm

- Made from high-quality materials, hardness 40HRC • Three cutting edges improving drilling performance • Guide drill 3.1 mm
- Countersink diameter 7 mm

Code	Ø [mm]		
31381	7	x	48/192

**3 HEX ADAPTORS FOR BI-METAL HOLE SAWS**

- ПЕРЕХОДНИКИ ШЕСТИГРАННЫЕ ДЛЯ СВЕРЛ КОРОНЧАТЫХ БИМЕТАЛЛИЧЕСКИХ • WALZENADAPTER FÜR BIMETALL-LOCHSÄGE



Code	Grip [mm]	Size [mm]		
27100	6	14 - 30	x	20/200
27101	11	32 - 140	x	10/100

**4 HOLE SAW SET**

- КОРОНКА С ВОЛЬФРАМОВОЙ НАСЫПЬЮ
- LOCHSÄGE MIT WOLFRAMAUFSCÜTTUNG



max 1500 RPM

x4 33/53/73/83 mm MAX 90mm WOLFRAM TCT HRC 90±2

- Made from high quality materials • Perfect for installation works • For drilling in tiles, bricks, walls, lightweight construction materials and gypsumboard • The set includes: guide drill 8 mm, backing plate and 4 hole-saws

Code	Hole saw diameter [mm]		
31396	33/53/73/83	x	5/20

**5 HOLE SAW MANDREL FOR HOLE SAW 31396**

- НАПРАВЛЯЮЩЕЕ СВЕРЛО ДЛЯ КОРОНКИ 31396
- ZENTRIERBOHRER FÜR LOCHSÄGEN 31396



TCT L 136mm 31396 TCT HRC 90±2

- Made from high quality materials, with TCT cutting blade • Designed for hole-saw 31396

Code	Length [mm]		
31397	136	x	1/120

**6 HOLE SAW**

- ПИЛА ДЛЯ ОТВЕРСТИЙ • LOCHSCHNEIDER



- For gypsumboard, plywood, wood and plastic panels • With diameter adjustment to 64 mm

Code	Range [mm]		
26400	do 64	x	6/60

**7 DEPTH STOPS 6/8/10**

- ОГРАНИЧИТЕЛИ ГЛУБИНЫ СВЕРЛЕНИЯ 6/8/10
- TIEFENBEGRENZER



x3 Ø 10mm Ø 8mm Ø 6mm HRC 50±2

- Made from high-quality materials, hardness 50 ± 2 HRC • Three most popular dimensions 6/8/10 mm • The set includes Allen wrench • Enable to drill in a material to the preset depth

Code	Length [mm]		
31393	6/8/10	x	24/192

**8 MINIGRINDER ACCESSORY KIT**

- НАБОР ПРИНАДЛЕЖНОСТЕЙ ДЛЯ МИНИШЛИФМАШИНЫ
- ZUBEHÖRSATZ FÜR MINISCHLEIFER



- Set of 71 pcs for minigrinders • Diamond-coated cutter, 5 pcs • Mandrel with a grinding stone, 4 pcs • Wire brushes, 2 pcs
- Adapters for sandpaper, polishing felt, grinding discs, 4 pcs • Polishing felts, 14 pcs • Grinding discs, 35 pcs • Mandrel adapters, 2 pcs • Sandpaper rolls, 4 pcs
- Abrasive compound, 1 pcs

Code	The quantity [pcs.]	
93171	71	10

PROLINE  
LAHTI PRO  
MEGA  
JUCO  
OTHER BRANDS  
ERDI  
KLINGSPOR  
EXPRESS  
ACTION CAN  
TRYTON  
VULCAN

**1 DIAMOND HOLE SAW**

• КОРОНКИ АЛМАЗНЫЕ • DIAMANT-LOCHSÄGE



• Hole saw with vacuum soldered process diamonds • Equipped with a handle with an M14 thread for direct mounting on an angle grinder • Designed for drilling in ceramic tiles, stone tiles and stoneware, among others • An adapter with a centering drill for combi drills (27200) can be used in hole saws of min. 20mm • Drilling is to be done dry

Code	Dimension (mm)	Box
27206	6	20/120
27208	8	20/120
27210	10	20/120
27212	12	20/120
27215	15	20/120
27220	20	20/120
27222	22	20/120
27225	25	20/120
27230	30	20/120
27235	35	20/120
27240	40	16/96
27251	51	6/36
27260	60	6/36
27268	68	3/18

**2 HEXAGONAL ADAPTOR FOR DIAMOND HOLE SAWS**

• ШЕСТИГРАННЫЙ АДАПТЕР ДЛЯ АЛМАЗНЫХ КОРОНОК  
• SECHSKANTADAPTER FÜR DIAMANT-LOCHSÄGEN



• Hexagonal handle • M14 thread • Includes the guide drill for hole saws 27220-27268

Code	Grip (mm)	Box
27200	11	10/100

**3 DIAMOND CORE DRILLS**

• АЛМАЗНЫЕ КОРОНЧАТЫЕ СВЕРЛА (ПОДРОЗЕТНИКИ)  
• DIAMANT-LOCHBOHRER



• Supplied with a hexagonal adapter, guide drill and drill drift • Drill Ø10 mm • Thread M16  
• For construction materials

Code	L (mm)	Diameter (mm)	Qty of teeth	Box
89568	75	68	4	20
89582	75	82	4	20
89569	150	68	3	20
89583	150	82	4	20

**4 PILOT DRILL BITS FOR DIAMOND HOLE CUTTERS**

• НАПРАВЛЯЮЩИЕ СВЕРЛА ДЛЯ АЛМАЗНЫХ КОРОНОК  
• PILOTBOHRER FÜR DIAMANTLOCHFRÄSER



• **89507:** Guide drill bit Ø 7 for diamond hole saws Proline 89568, 89582  
• **89510:** Guide drill bit Ø 10 for diamond hole saws Proline 89569, 89583

Code	Box
89507	100
89510	100

**5 SDS PLUS ADAPTOR**

• ПЕРЕХОДНИК - АДАПТЕР SDS PLUS • SDS-PLUS-ADAPTER



• Thread M16 • Drill opening dia. 10 mm  
• For diamond drills with codes: 89568, 89569, 89582, 89583

Code	Dimensions (mm)	Box
89590	100	50/100

**6 MULTI TOOL ACCESSORIES**

• ПРИНАДЛЕЖНОСТИ ДЛЯ МНОГОФУНКЦИОНАЛЬНЫХ ИНСТРУМЕНТОВ С ПАТРОНОМ НА КЛЮЧ (TM300)  
• ZUBEHÖR FÜR MULTIFUNKTIONSGERÄTE MIT GRIFF FÜR SCHLÜSSEL (TM300)



• Components: delta foot 1 pc., straight jaw 1 pc., stripping tool 1 pc., rounded saw 1 pc., semicircular

Code	Box	Qty
93126	x	40

**7 MULTI TOOL ABRASIVE PAD PAPER SHEET SET**

• НАБОР НАЖДАЧНОЙ БУМАГИ DELTA ДЛЯ МНОГОФУНКЦИОНАЛЬНЫХ ИНСТРУМЕНТОВ (TM300)  
• SCHLEIFPAPIERSATZ DELTA FÜR MULTIFUNKTIONSGERÄTE (TM300)



• Sandpaper delta 10pcs. (granulation 2 x 80, 2 x 120, 3 x 180, 3 x 240)

Code	Box	Qty
93110	x	100







**1 ROUTER BIT SET**  
• НАБОР ФРЕЗ - 6 ШТ • FRÄSENSATZ



Ø 8mm HRC 87±2

- The set includes: plunge cutter 6.3 mm, slot cutter 6 mm, end mill cutter for edge rounding 6.3 mm, cutter for smoothing 12.7 mm, slot cutter 12 mm, cutter for dovetail keys 12.7 mm

Code	Quantity (pcs.)	Box
93121	6	50

**2 ROUTER BIT SET**  
• НАБОР ФРЕЗ - 12 ШТ • FRÄSENSATZ



Ø 8mm HRC 87±2

- The set includes: plunge cutter 6.3 mm, slot cutter 6 mm, end mill cutter for edge rounding 6.3 mm, cutter for smoothing 12.7 mm, slot cutter 12 mm, cutter for dovetail keys 12.7 mm, ball cutter 6.3 mm, end mill for chamfering 32 mm, slot cutter 16 mm, end mill cutter for edge rounding 9.5 mm, slot cutter v 12.7 mm, end mill 4 mm

Code	Quantity (pcs.)	Box
93122	12	20

**3 RECIPROCATING SAW BLADES FOR WOOD SET**

- НАБОР ПИЛОЧЕК ДЛЯ ДЕРЕВА ДЛЯ САБЕЛЬНОЙ ПИЛЫ
- SÄGEBLATTSATZ FÜR HOLZ



6 TPI 152 mm HCS HRC 51±2

Code	Quantity (pcs.)	Box
93123	3	x 40/160

**4 RECIPROCATING SAW BLADES FOR METAL SET**

- НАБОР ПИЛОЧЕК ДЛЯ МЕТАЛЛА ДЛЯ САБЕЛЬНОЙ ПИЛЫ
- SÄGEBLATTSATZ FÜR METALL



18 TPI 152 mm BiM HRC 61±2

Code	Quantity (pcs.)	Box
93124	3	x 40/160

**5 RECIPROCATING SAW BLADES FOR WOOD AND METAL SET**

- НАБОР ПИЛОЧЕК ДЛЯ ДЕРЕВА И МЕТАЛЛА ДЛЯ САБЕЛЬНОЙ ПИЛЫ
- SÄGEBLATTSATZ FÜR HOLZ UND METALL



for wood 6/8/10 TPI 152 mm HCS HRC 51±2

for metal 14/18 TPI 152 mm BiM HRC 61±2

Code	Quantity (pcs.)	Box
93125	5	x 40/160

SELECTION OF JIGSAW BLADES FROM PROLINE

**1. Choice of blade depending on the type of blade clamp in the jigsaw**







Grip	Grip Name	Used in jigsaws from:
	Type T (T-shaped) (Type BOSCH)	AEG, ATLAS KOPRO, BOSCH, DeWALT, ELU, FESTO, FLEX, HITACHI, KANGO, KRESS, LENOX, HOLZHER, MAFELL, MAKITA, METABO, MILWAUKEE, PERLES, SPARKY, TRYTON, VULCAN CONCEPT
	Type U (universal) (Type Black & Decker)	BLACK & DECKER, KRESS, RYOBI, SKIL, STAYER, WOLF

**2. Choice of jigsaw blade depending on the material it is made of.**



To choose the correct blade for your needs, first specify the type of material to be cut (wood, metal, plastic), the thickness of the workpiece (blades have different work ranges), the accuracy with which the workpiece is to be cut (roughly and quickly or slowly and accurately) and finally the shape of the cut (straight, curved, mixed)

Marking	Description
<b>HCS</b>	Carbon tool steel, the cheapest saw blades with the shortest lifespan, mainly intended for cutting soft materials such as wood, fibre board, plastic laminated boards and plastics. Smooth blades made of this material can be used for cutting in materials such as polystyrene.
<b>CV</b>	High quality alloy steel, chrome-vanadium. Blades with a good price-performance ratio, intended for cutting wood, furniture boards and plastics.
<b>HSS</b>	High-speed high-alloy tool steel, perfect blades for cutting wood-based materials, wood with nails, but mainly for steel, thin steel sheets and non-ferrous metal cutting.
<b>Bi-metal</b>	A combination of elastic carbon or chrome vanadium steel with HSS high-speed steel, the most expensive version of premium quality blades with several times longer working time, which allows cutting both wood, plastics and metals.
<b>HM, TC</b>	A niche group of saw blades are blades with a tungsten carbide coating or with carbide inserts on HM teeth. These are blades designed for cutting very hard materials such as stainless steel, ceramic tiles, etc.

**3. Selection of blade depending on the material type and thickness:**

			<table border="1"><tr><td>Cu</td><td>Ni</td></tr><tr><td>Ms</td><td>Zn</td></tr></table>	Cu	Ni	Ms	Zn				
Cu	Ni										
Ms	Zn										
CARBON STEEL	INOX - stainless steel	ALUMINIUM	NON-FERROUS METALS	SOFT WOOD	HARD WOOD	PLYWOOD	PLASTICS				

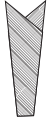
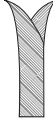
**4. Selection of a saw blade depending on the type of teeth**

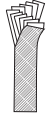









			
Ground	Ground side-set	Milled side-set	Milled wavy





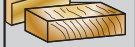





**5. Selection of the saw blade depending on cutting accuracy**

(i.e. the TPI, pitch of the teeth - the quantity of teeth per inch of the saw blade [1 inch = 25.4 mm])

Processed Material	Tooth pitch	Cutting accuracy
METAL	14 - 24 TPI	The higher the pitch value (finer teeth) the greater the cutting accuracy, but the lower the cutting speed
METAL WOOD AND PLASTICS	2 - 12 TPI	



**6. Selection of saw blade depending on the type of cut:**

Type of cut	Recommended blade width	Image of blade
 cutting straight or with a minimum arc	approx. 7-8 mm	
 cutting along a sharp arc	ok. 4 mm	
 cutting soft wood, rough cutting	approx. 7-8 mm 6-8TPI	
 cutting wood or finishing boards	ok. 7-8 mm 10-12TPI	
 safe cutting of laminated boards	ok. 7-8 mm 10-12TPI	

 Softwood, joinery boards	 Laminated boards	 Plywood	 Rough straight cuts	 Plywood cutting thickness 4-30 mm
 Hard wood, MDF, chipboard	 Accurate straight-line cutting	 Kitchen tops and worktops	 Curvilinear cutting	 Wood cutting thickness 4-30 mm

ВЫБОР ПИЛЬНЫХ ДИСКОВ PROLINE

1. Выбор пильного диска в зависимости от типа зажима в пиле

Держатель	Название	Используется в лобзиках производства
	Типе Т (т-образный) (Типе BOSCH)	AEG, ATLAS KOPRO, BOSCH, DeWALT, ELU, FESTO, FLEX, HITACHI, KANGO, KRESS, LENOX, HOLZHER, MAFELL, MAKITA, METABO, MILWAUKEE, PERLES, SPARKY, TRYTON, VULCAN CONCEPT
	Типе U (универсальный) (Типе Black & Decker)	BLACK & DECKER, KRESS, RYOBI, SKIL, STAYER, WOLF

2. Выбор пильного диска в зависимости от материала, из которого он изготовлен.



Чтобы выбрать лезвие, соответствующее вашим потребностям, сначала укажите тип обрабатываемого материала (древесина, металл, пластик), толщину заготовки (пильные диски имеют разные диапазоны обработки), точность, с которой должна быть разрезана заготовка (приблизительно и быстро или медленно и точно), а также форму распила (прямой, изогнутый, комбинированный)

Маркировка	Описание
<b>HCS</b>	Углеродистая инструментальная сталь, наиболее дешевые пильные диски с наименьшим сроком службы, предназначенные в основном для резки мягких материалов, таких как древесина, ДВП, пластиковые ламинированные плиты и пластмассы. Гладкие пильные диски из этого материала можно использовать для резки таких материалов, как полистирол.
<b>CV</b>	Высококачественная легированная сталь, хром-ванадий. Пильные диски с хорошим соотношением цены и качества, предназначенные для резки древесины, мебельных плит и пластмасс.
<b>HSS</b>	Быстрорежущая высоколегированная инструментальная сталь, идеальные пильные диски для резки древесных материалов, дерева с гвоздями, но в основном для резки стали, тонких стальных листов и цветных металлов.
<b>Биметаллические диски</b>	Сочетание эластичной углеродистой или хромованадиевой стали с быстрорежущей сталью HSS - наиболее дорогой вариант пильных дисков премиум-класса с увеличенным в несколько раз временем работы, позволяющий резать как древесину, так и пластмассу или металл.
<b>HM, TC</b>	Отдельная группа пильных дисков - это диски с покрытием из карбида вольфрама или твердосплавными вставками на зубьях HM. Это диски, предназначенные для резки очень твердых материалов, таких как нержавеющая сталь, керамическая плитка и т.д.

3. Выбор пильного диска в зависимости от типа и толщины материала:

			<table border="1"><tr><td>Cu</td><td>Ni</td></tr><tr><td>Ms</td><td>Zn</td></tr></table>	Cu	Ni	Ms	Zn				
Cu	Ni										
Ms	Zn										
УГЛЕРОДИСТАЯ СТАЛЬ	INOX - нержавеющая сталь	АЛЮМИНИЙ	ЦВЕТНЫЕ МЕТАЛЛЫ	МЯГКАЯ ДРЕВЕСИНА	ТВЕРДАЯ ДРЕВЕСИНА	ФАНЕРА	ПЛАСТИК				

4. Выбор пильного диска в зависимости от типа зубьев

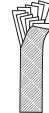
			
Шлифованный	Шлифованный разведенный	Сточенный	Сточенный волнистый











5. Выбор пильного диска в зависимости от точности распила

(например TPI, шаг зубьев - количество зубьев на дюйм пильного диска (1 дюйм = 25,4 мм))

Обрабатываемый материал	Шаг зуба	Точность резки
МЕТАЛЛ	14 - 24 TPI	Чем выше значение шага (более мелкие зубья), тем выше точность, но ниже скорость резки
МЕТАЛЛ, ДРЕВЕСИНА И ПЛАСТИК	2 - 12 TPI	



6. Выбор пильного диска в зависимости от типа распила:

Тип распила	Рекомендуемая ширина диска	Изображение диска
 прямой распил или с минимальной дугой	приб. 7-8 мм	
 распил по острой дуге	приб. 4 мм	
 резка мягкой древесины, грубый распил	приб. 7-8 мм 6-8TPI	
 резка древесины или отделочных плит	приб. 7-8 мм 10-12TPI	
 безопасная резка ламинированных плит	приб. 7-8 мм 10-12TPI	

 Хвойные, столярные доски	 Ламинированные доски	 Фанера	 Грубые прямые распилы	 Толщина распила фанеры 4-30 мм
 Твердая древесина, МДФ, ДСП	 Точный прямолинейный распил	 Кухонные и рабочие столешницы	 Криволинейный распил	 Толщина распила древесины 4-30 мм

AUSWAHL VON STICHSÄGEBLATT VON PROLINE

**1. Wahl des Stichsägeblattes nach der Art der Klemme für das Stichsägeblatt in der Stichsäge**







Schaft	Name	Verwendet bei Stichsägen der Hersteller:
	Typ T (Typ BOSCH)	AEG, ATLAS KOPRO, BOSCH, DeWALT, ELU, FESTO, FLEX, HITACHI, KANGO, KRESS, LENOX, HOLZHER, MAFELL, MAKITA, METABO, MILWAUKEE, PERLES, SPARKY, TRYTON, VULCAN CONCEPT
	Typ U (universell) (Typ Black & Decker)	BLACK & DECKER, KRESS, RYOBI, SKIL, STAYER, WOLF

**2. Wahl des Stichsägeblattes nach der Materialart, aus der das Stichsägeblatt gefertigt ist**

Um das richtige Stichsägeblattes für Ihre Anforderungen auszuwählen, müssen Sie zuerst die Art des zu schneidenden Materials (Holz, Metall, Kunststoff), die Dicke des Werkstücks (Klingen haben unterschiedliche Arbeitsbereiche), die Genauigkeit, mit der das Werkstück geschnitten werden soll (grob und schnell oder langsam und genau) und schließlich die Form des Schnittes (gerade, gebogen, gemischt) festlegen.

Kennzeichnung	Beschreibung
<b>HCS</b>	Carbon-Werkzeugstahl, die billigsten Sägeblätter mit der kürzesten Lebensdauer; hauptsächlich für das Schneiden von weichen Materialien wie Holz, Faserplatten, Kunststofflaminatplatten und Kunststoffen bestimmt. Glatte Sägeblätter aus diesem Material können zum Schneiden von Materialien wie Styropor verwendet werden.
<b>CV</b>	Hochwertiger Legierungsstahl, Chrom-Vanadium. Sägeblätter mit gutem Preis-Leistung-Verhältnis, die zum Schneiden von Holz, Möbelplatten und Kunststoffen bestimmt sind.
<b>HSS</b>	Hochleistungsschnellarbeitsstahl für Werkzeuge, perfekte Sägeblätter zum Schneiden von Holzwerkstoffen, Holz mit Nägeln, vor allem aber für Stahl, dünne Stahlbleche und das Schneiden von NE-Metallen.
<b>Bi-metal</b>	Eine Kombination aus elastischem Kohlenstoff- oder Chrom-Vanadium-Stahl mit HSS-Schnellarbeitsstahl, die teuerste Version von Premium-Qualitätsblättern mit um ein Vielfaches längeren Arbeitszeiten; das Schneiden von Holz, Kunststoffen und Metallen ist möglich.
<b>HM, TC</b>	Eine Nischengruppe von Sägeblättern sind Sägeblätter mit einer Wolframkarbidbeschichtung oder mit Hartmetalleinsätzen auf HM-Zähnen. Diese Klingen sind für das Schneiden sehr harter Materialien wie Edelstahl, Keramikfliesen usw. konzipiert.

**3. Wahl des Stichsägeblattes nach Materialart und -stärke:**

			<table border="1"><tr><td>Cu</td><td>Ni</td></tr><tr><td>Ms</td><td>Zn</td></tr></table>	Cu	Ni	Ms	Zn				
Cu	Ni										
Ms	Zn										
CARBON-STAHL	INOX - Edelstahl	ALUMINIUM	EISENFREIE METALLE	WEICHHOLZ	HARTHOLZ	SPERRHOLZ	KUNSTSTOFF				

**4. Wahl des Stichsägeblattes nach Zahnart**

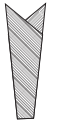
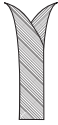
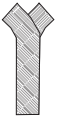
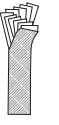









			
Geschliffen	Geschliffen, geschränkt	Gefräst, geschränkt	Gefräst, gewellt

**5. Wahl des Stichsägeblattes nach Schnittgenauigkeit**

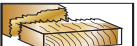
(z. B. der TPI, die Zahndichte - die Anzahl der Zähne pro Inch des Sägeblattes (1 Inch = 25.4 mm))

Werkmaterial	Zahnanzahl	Schnittgenauigkeit
METALL	14 - 24 TPI	Je höher die Zahnanzahl (feinere Zähne) desto höher ist die Schnittgenauigkeit,
METALL, HOLZ UND KUNSTSTOFF	2 - 12 TPI	aber desto geringer ist auch die Schnittgeschwindigkeit

**6. Wahl des Stichsägeblattes nach Schnittart:**

Schnittart	Empfohlene Sägeblattweite	Produkt
 gerader Schnitt oder schnitt mit minimalem Bogen	ca. 7-8 mm	
 Schnitt entlang eines scharfen Bogens	ca. 4 mm	
 Schneiden von Weichholz, raues Schneiden	ca. 7-8 mm 6-8TPI	
 Schneiden von Holz und Veredlungstafeln	ca. 7-8 mm 10-12TPI	
 sicheres Schneiden von laminierten Brettern	ca. 7-8 mm 10-12TPI	

 Weichholz, Tischlereibretter	 Laminierte Bretter	 Sperrholz	 Raue gerade Schnitte	 Sperrholzschnittstärke
 Hartholz, MDF, Spanholz	 Genaue, gradlinige Schnitte	 Küchenplatten und Arbeitsplatten	 Krummliniges Schneiden	 Holzschnittstärke

**1 JIGSAW BLADES**

• ПИЛОЧКИ ДЛЯ ЭЛЕКТРОЛОБЗИКОВ • SÄGEBLÄTTER FÜR STICHSÄGE

- High-quality CrV steel
- Blades for wood, wood products, plastic, steel stainless steel, nonferrous metals
- Made in Germany
- In the set of 5 on a card

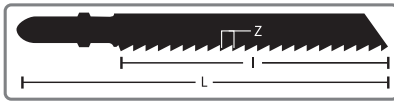

**WOOD BLADES**

Code	Grip	Blade length (Tooth type)	TPI / tooth pitch (mm)	Tooth length/width (mm)	Tooth type	
------	------	---------------------------	------------------------	-------------------------	------------	--

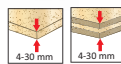
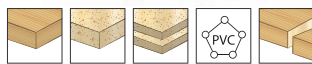

• Precise, clean cut

93101	Type T	100mm / 4"	10TPI / 2,5mm	75	ground convergent	5
93401	Type U	100mm / 4"	10TPI / 2,5mm	75	ground convergent	5

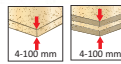
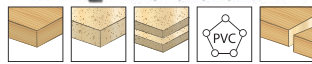

• Precise, clean cut

93101L	Type T	132mm / 5,2"	10TPI / 2,5mm	110	ground convergent	5
--------	--------	--------------	---------------	-----	-------------------	---

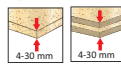
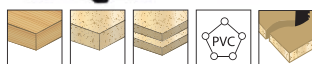

• Precise, curvilinear cut

93101KR	Type T	100mm / 4"	10TPI / 2,5mm	75	ground convergent	5
93401KR	Type U	100mm / 4"	10TPI / 2,5mm	75	ground convergent	5

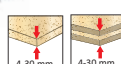

• Precise, clean cutting of laminated boards

93102	Type T	100mm / 4"	10TPI / 2,5mm	75	ground convergent	5
93402	Type U	100mm / 4"	10TPI / 2,5mm	75	ground convergent	5

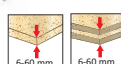
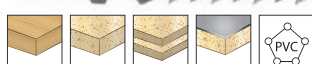

• Precise, fast cutting

93103	Type T	100mm / 4"	6TPI / 4,0mm	75	ground convergent	5
93403	Type U	100mm / 4"	6TPI / 4,0mm	75	ground convergent	5

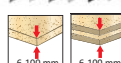

• Precise, fast cutting

93103L	Type T	132mm / 5,2"	6TPI / 4,0mm	110	ground convergent	5
--------	--------	--------------	--------------	-----	-------------------	---

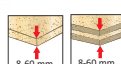

• Very fast cutting

93104	Type T	100mm / 4"	6TPI / 4,0mm	75	ground open	5
93404	Type U	100mm / 4"	6TPI / 4,0mm	75	ground open	5

Code	Grip	Blade length (Tooth type)	TPI / tooth pitch (mm)	Tooth length/width (mm)	Tooth type	
------	------	---------------------------	------------------------	-------------------------	------------	--

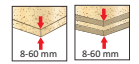
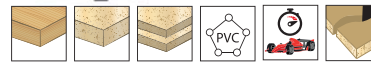

• Very fast curvilinear cutting

93105	Type T	100mm / 4"	6TPI / 4,0mm	75	ground open	5
93405	Type U	100mm / 4"	6TPI / 4,0mm	75	ground open	5

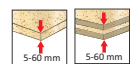
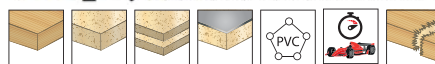

• Very fast coarse cutting

93106	Type T	100mm / 4"	8TPI / 3,0mm	75	milled wavy	5
93406	Type U	100mm / 4"	8TPI / 3,0mm	75	milled wavy	5

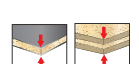
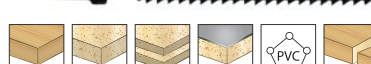

• Straight cutting of plexiglass, wood, particle boards

93108	Type T	75mm / 3"	12TPI / 2,0mm	50	milled wavy	5
93408	Type U	75mm / 3"	12TPI / 2,0mm	50	milled wavy	5

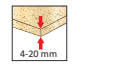
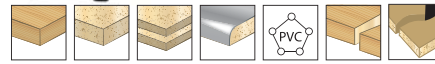

• Curvilinear cutting of plexiglass, wood, particle boards

93109	Type T	75mm / 3"	12TPI / 2,0mm	50	milled wavy	5
93409	Type U	75mm / 3"	12TPI / 2,0mm	50	milled wavy	5

**METAL BLADES**

Code	Grip	Blade length (Tooth type)	TPI / tooth pitch (mm)	Tooth length/width (mm)	Blade length (Tooth type)	
------	------	---------------------------	------------------------	-------------------------	---------------------------	--

Material - high-quality high-alloy HSS tool steel

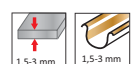
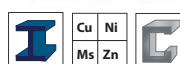

• Precise, straight cutting of steel, aluminum and non-ferrous metals

93111	Type T	75mm / 3"	21TPI / 1,2mm	50	milled wavy	5
93411	Type U	75mm / 3"	21TPI / 1,2mm	50	milled wavy	5

Material - a combination of elastic carbon or chrome vanadium steel with HSS high-speed steel



• Precise, straight cutting of steel, INOX, aluminum, non-ferrous metals

93111F	Type T	75mm / 3"	21TPI / 1,2mm	50	milled wavy	5
93411F	Type U	75mm / 3"	21TPI / 1,2mm	50	milled wavy	5



• Universal blade

93150F	Type T	132mm / 5,2"	10TPI / 1,8mm	110	milled variables	5
93450F	Type U	132mm / 5,2"	10TPI / 1,8mm	110	milled variables	5

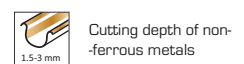
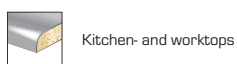
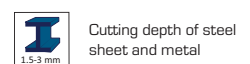
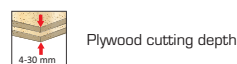
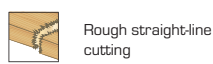
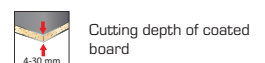
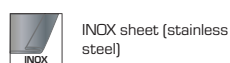
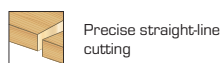
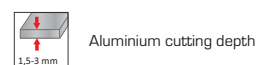
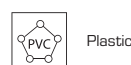
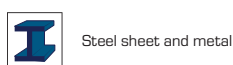
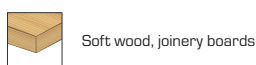

# PROLINE ABRASIVE BRUSHES

PROLINE

LAHTI PRO

MEGA

JUCO

OTHER BRANDS

ERDI









KUNGSFOR

EXPRESS

ACTION CAN

TRYTON

VULCAN

type	type	picture
A - wire cup brushes	a - crimped wire cup brushes	
	b - knot-twisted wire cup brushes	
B - wire wheel brushes	a - crimped wire wheel brushes	
	b - knot-twisted wire wheel brushes	
C - crimped wire shaft-mounted brushes	a - crimped wire shaft-mounted brushes	
	b - knot-twisted wire shaft-mounted brushes	
A - nylon cup brushes	a - shaft-mounted nylon cup brushes	
	B - nylon wheel brushes	a - shaft-mounted nylon wheel brushes
C - crimped nylon brushes	a - shaft-mounted crimped brushes	



for drills and screw drivers, with 6 mm shaft



for M14 angle grinders



for table grinders



twisted steel wire







crimped brass wire



nylon

# АБРАЗИВНЫЕ ЩЕТКИ PROLINE

тип	тип	рисунок
А - чашечные проволочные щетки	а - чашечные щетки из волнистой проволоки	
	б - чашечные щетки из проволочной сетки	
В - дисковые проволочные щетки	а - дисковые щетки из волнистой проволоки	
	б - дисковые щетки из проволочной сетки	
С - щетки на валу из волнистой проволоки	а - щетки на валу из волнистой проволоки	
	б - щетки на валу из проволочной сетки	
А - нейлоновые чашечные щетки	а - нейлоновые чашечные щетки на валу	
В - нейлоновые дисковые щетки	а - нейлоновые дисковые щетки на валу	
С - нейлоновые щетки из волнистой проволоки	а - щетки из волнистой проволоки на валу	



для дрелей и отверток, с хвостовиком 6 мм



для угла М14 шлифовальные машины



для настольных шлифовальных машин



скрученная стальная проволока

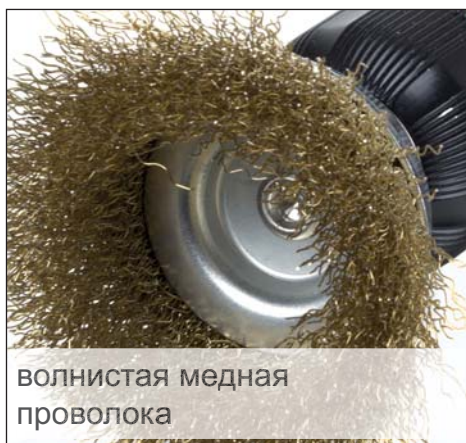

волнистая медная проволока



нейлон

# PROLINE SCHLEIFBÜRSTEN

Typ	Typ	Bild
A - Drahtschalenbürsten	a - Gecrimpte Drahtschalenbürsten	
	b - Zopfschalenbürsten	
B - Rundbürsten	a - Gecrimpte Rundbürsten	
	b - Zopfrundbürsten	
C - Gecrimpte Drahtbürsten mit Schaftbefestigung	a - Gecrimpte Drahtbürsten mit Schaftbefestigung	
	b - Zopfbürsten mit Schaftbefestigung	
A - Nylonschalenbürsten	a - Nylonschalenbürsten mit Schaftbefestigung	
	B - Nylonrundbürsten	a - Nylonrundbürsten mit Schaftbefestigung
C - Gecrimpte Nylonbürsten	a - Gecrimpte Bürsten mit Schaftbefestigung	



für Bohrmaschinen und Schraubendreher mit 6 mm Schaft



für M14 Winkelschleifer



für Tischschleifer



gezopfter Stahldraht



gecrimpter Messingdraht



Nylon

PROLINE  
LAHTI PRO  
MEGA  
JUCO  
OTHER BRANDS  
ERDI  
KLINGSPOR  
EXPRESS  
ACTION CAN  
TRYTON  
VULCAN



**1 TWIST KNOT WIRE CUP BRUSH**

• ТОРЦЕВАЯ ЧАШЕЧНАЯ ЩЕТКА ИЗ СКРУЧЕННОЙ ПРОВОЛОКИ С ХВОСТОВИКОМ • STIRNBÜRSTE MIT SCHAFT



- Steel twisted wire
- For heavy and very heavy works
- Remove paint, lagging, scale and sharp edges

Code	Diameter (mm)		
32457	75	x	12/120

**4 ABRASIVE CUP BRUSHES**

• ТОРЦЕВЫЕ ЧАШЕЧНЫЕ АБРАЗИВНЫЕ ЩЕТКИ С ХВОСТОВИКОМ • STIRNBÜRSTEN MIT SCHAFT



- Nylon

Code	Diameter (mm)		
32915	50	x	12/120
32917	75	x	12/120

**7 ABRASIVE END BRUSH**

• КОНЦЕВАЯ ТОРЦЕВАЯ АБРАЗИВНАЯ ЩЕТКА С ХВОСТОВИКОМ • PINSELBÜRSTE MIT SCHAFT



- Nylon

Code	Diameter (mm)		
32924	24	x	20/200

**2 CRIMPED WIRE CUP BRUSHES**

• ТОРЦЕВЫЕ ЧАШЕЧНЫЕ ЩЕТКИ ИЗ ВОЛНИСТОЙ ПРОВОЛОКИ С ХВОСТОВИКОМ • PINSELBÜRSTEN MIT SCHAFT



- Steel undulating wire
- For removing corrosion, paint, blunting sharp edges etc.

Code	Diameter (mm)		
32406	60	x	12/120
32408	80	x	12/120
32410	100	x	6/60

**5 TWIST KNOT WIRE CUP BRUSH**

• КОНЦЕВАЯ ТОРЦЕВАЯ ЧАШЕЧНАЯ ЩЕТКА ИЗ СКРУЧЕННОЙ ПРОВОЛОКИ С ХВОСТОВИКОМ • PINSELBÜRSTE MIT SCHAFT



- Steel twisted wire
- For any works, e.g. removal of paint, corrosion etc.

Code	Diameter (mm)		
32452	22	x	20/200

**8 TWIST KNOT WIRE WHEEL BRUSH**

• ДИСКОВАЯ ЩЕТКА ИЗ СКРУЧЕННОЙ ПРОВОЛОКИ С ХВОСТОВИКОМ • SCHEIBENBÜRSTE MIT SCHAFT



- Steel twisted wire
- For heavy and very heavy works
- Remove paint, lagging, scale and sharp edges

Code	Diameter (mm)		
32447	75	x	12/120

**3 CRIMPED BRASS PLATED WIRE CUP BRUSHES**

• ТОРЦЕВЫЕ ЧАШЕЧНЫЕ ЩЕТКИ ИЗ ВОЛНИСТОЙ ПРОВОЛОКИ С ХВОСТОВИКОМ • STIRNBÜRSTEN MIT SCHAFT



- Brass-covered undulating wire
- For removing corrosion, paint, blunting sharp edges

Code	Diameter (mm)		
32845	50	x	12/120
32847	75	x	12/120

**6 CRIMPED BRASS PLATED WIRE CUP BRUSHES**

• КОНЦЕВЫЕ ТОРЦЕВЫЕ ЩЕТКИ ИЗ ВОЛНИСТОЙ ПРОВОЛОКИ С ХВОСТОВИКОМ • PINSELBÜRSTE MIT SCHAFT



- Brass-covered undulating wire
- For removing corrosion, paint, blunting sharp edges

Code	Diameter (mm)		
32861	17	x	20/200
32862	24	x	20/200

**9 CRIMPED WIRE WHEEL BRUSHES**

• ДИСКОВЫЕ ЩЕТКИ ИЗ ВОЛНИСТОЙ ПРОВОЛОКИ С ХВОСТОВИКОМ • SCHEIBENBÜRSTEN MIT SCHAFT



- Brass-covered undulating wire
- For removing corrosion, paint, blunting sharp edges

Code	Diameter (mm)		
32426	63	x	12/120
32428	80	x	12/120
32430	100	x	12/120
32432	120	x	12/60

PROLINE

LAHTI PRO

MEGA

JUCO

OTHER BRANDS

ERDI

KLINGSPOR

EXPRESS

ACTION CAN

TRAYTON

VULCAN

### 1 CRIMPED BRASS PLATED WIRE WHEEL BRUSHES

• ДИСКОВЫЕ ЩЕТКИ ИЗ ВОЛНИСТОЙ ПРОВОЛОКИ С ХВОСТОВИКОМ • SCHEIBENBÜRSTEN MIT SCHAFT



- Brass-covered undulating wire
- For any works, e.g. removal of paint, corrosion etc.

Code	Diameter (mm)		
32827	75	x	12/120
32830	100	x	12/120

### 4 CRIMPED WIRE WHEEL BRUSHES

• ДИСКОВЫЕ ЩЕТКИ ИЗ ВОЛНИСТОЙ ПРОВОЛОКИ С ПОСАДОЧНЫМ ОТВЕРСТИЕМ • SCHEIBENBÜRSTEN



- Steel undulating wire
- For any heavy and semi-heavy works, e.g. removal of paint, corrosion etc.

Code	Diameter (mm)	Opening (mm)		
32542	125	12.7; 16; 20	x	6/60
32545	150	12.7; 16; 20; 22; 25; 32	x	6/30
32549	200	12.7; 16; 20; 22; 25; 32	x	6/24

### 7 CRIMPED WIRE WHEEL BRUSHES

• ДИСКОВЫЕ ЩЕТКИ ИЗ ВОЛНИСТОЙ ПРОВОЛОКИ С РЕЗЬБОЙ • SCHEIBENBÜRSTEN MIT GEWINDE



- Steel undulating wire
- For any heavy and semi-heavy works, e.g. removal of paint, corrosion etc.

Code	Diameter (mm)		
32520	100	x	12/60
32521	115	x	6/60

### 2 ABRASIVE WHEEL BRUSHES

• ДИСКОВЫЕ АБРАЗИВНЫЕ ЩЕТКИ С ХВОСТОВИКОМ • SCHEIBENBÜRSTEN MIT SCHAFT



- Nylon

Code	Diameter (mm)		
32907	75	x	12/120
32910	100	x	12/120

### 5 CRIMPED BRASS PLATED WIRE WHEEL BRUSHES

• ДИСКОВЫЕ ЩЕТКИ ИЗ ВОЛНИСТОЙ ПРОВОЛОКИ С ПОСАДОЧНЫМ ОТВЕРСТИЕМ • SCHEIBENBÜRSTEN



- Brass-covered undulating wire
- For any works, e.g. removal of paint, corrosion etc.

Code	Diameter (mm)	Opening (mm)		
32805	50	6.4	x	12/240
32807	75	10; 12.7	x	12/120
32810	100	10; 12.7	x	12/120
32812	115	10; 12.7; 16	x	6/60
32815	150	12.7; 16	x	6/60

### 8 TWIST KNOT WIRE CUP BRUSHES

• ТОРЦЕВЫЕ ЧАШЕЧНЫЕ ЩЕТКИ ИЗ СКРУЧЕННОЙ ПРОВОЛОКИ С РЕЗЬБОЙ • STIRNBÜRSTEN MIT GEWINDE



- Steel twisted wire
- Aggressive brushes for quick and heavy work on a large surface
- Remove scale, paint, corrosion

Code	Diameter (mm)		
32576	65	x	6/60
32578	80	x	6/60
32580	100	x	5/20

### 3 TWIST KNOT WIRE WHEEL BRUSHES

• ДИСКОВЫЕ ЩЕТКИ ИЗ СКРУЧЕННОЙ ПРОВОЛОКИ С ПОСАДОЧНЫМ ОТВЕРСТИЕМ • SCHEIBENBÜRSTEN



- Steel twisted wire
- Remove paint, lagging, scale and sharp edges
- For heavy and very heavy works

Code	Diameter (mm)		
32550	100	x	12/60
32551	115	x	6/60
32555	150	x	6/30
32558	175	x	6/24

### 6 TWIST KNOT WIRE WHEEL BRUSHES

• ДИСКОВЫЕ ЩЕТКИ ИЗ СКРУЧЕННОЙ ПРОВОЛОКИ С РЕЗЬБОЙ • SCHEIBENBÜRSTEN MIT GEWINDE



- Steel twisted wire
- For heavy and very heavy works
- Remove paint, lagging, scale and sharp edges

Code	Diameter (mm)		
32530	100	x	12/60
32532	125	x	6/30

### 9 CRIMPED WIRE CUP BRUSHES

• ТОРЦЕВЫЕ ЧАШЕЧНЫЕ ЩЕТКИ ИЗ ВОЛНИСТОЙ ПРОВОЛОКИ С РЕЗЬБОЙ • STIRNBÜRSTEN MIT GEWINDE



- Steel undulating wire
- For light and semi-heavy removal of corrosion, paint, blunting sharp edges

Code	Diameter (mm)		
32507	75	x	6/60
32510	100	x	6/30

# PROLINE DIAMOND BLADES

A diamond blade consists of a metal body, along whose perimeter there is a rim with diamond sintered in a metal bonding material. Industrial diamonds (synthetic) of various sizes and grains are used, depending on the purpose of the blades - between 15 and 30% diamond

max. rotation speed

external blade diameter

internal blade diameter

segment thickness

segment height

segment with diamond

Safety pictograms

- Please read the instruction manual before use
- Use protective gloves
- Do not use the blade without a cover
- Always use a protective helmet!
- Always wear ear guards
- Always use safety goggles
- Always use a face mask!

89015 www.proline-tools.pl

Processes used for joining the core with the rim:

- laser welding - the strongest connection,
- soldering - silver solder is used to connect the segments to the metal disc,
- sintering.

Product code

## DIVISION OF BLADES

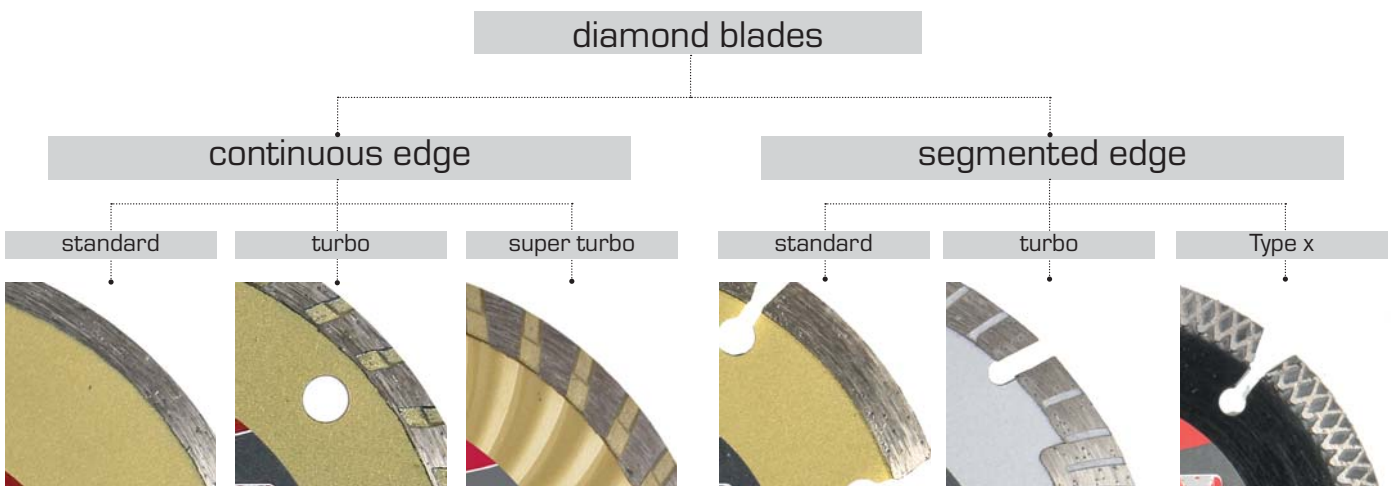

PROLINE  
LAHTI PRO  
MEGA  
JUCO  
OTHER BRANDS  
ERDI  
KUNGSPOOR  
ACTION CAN  
TRIVTON  
VULCAN

# АЛМАЗНЫЕ ДИСКИ PROLINE

Алмазный диск состоит из металлического корпуса, по периметру которого находится ободок с алмазом, спеченным в металлическом связующем материале. Используются промышленные (синтетические) алмазы различных размеров и зернистости, в зависимости от использования дисков - от 15 до 30% содержания алмаза



Процессы, используемые для соединения сердечника с ободком:

- лазерная сварка - наиболее прочное соединение,
- пайка - для соединения сегментов с металлическим диском используется серебряный припой,
- спекание.

## ВИДЫ ДИСКОВ

### алмазные диски

#### непрерывная кромка

#### сегментированная кромка

стандарт

турбо

супер турбо

стандарт

турбо

Тип x

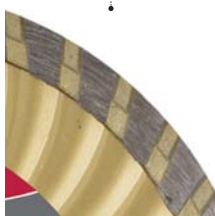
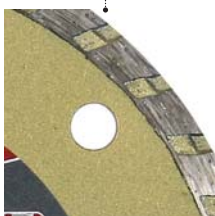
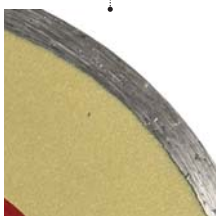

# PROLINE DIAMANTSCHLEIBEN

Eine Diamantscheibe besteht aus einer Metallscheibe, an deren Außenrand sich ein gesinterter Diamantrand in einem Metallklebematerial befindet. Industriediamanten (synthetische Diamanten) verschiedener Größen und Körnungen werden verwendet, je nach Verwendungszweck der Scheibe - zwischen 15 und 30% Diamanten

max. Drehgeschwindigkeit

Außendurchmesser der Scheibe

Innendurchmesser der Scheibe

Segmentdicke

Segmenthöhe

Segment mit Diamanten

Sicherheitspiktogramme

Bitte lesen Sie vor Gebrauch die Bedienungsanleitung.

Sicherheitshandschuhe verwenden.

Scheibe nicht ohne Abdeckung verwenden.

Immer Schutzhelm verwenden!

Immer Gehörschutz tragen!

Immer Schutzbrille verwenden!

Immer Gesichtsschutz verwenden!

Produktcode

89015 www.proline-tools.pl







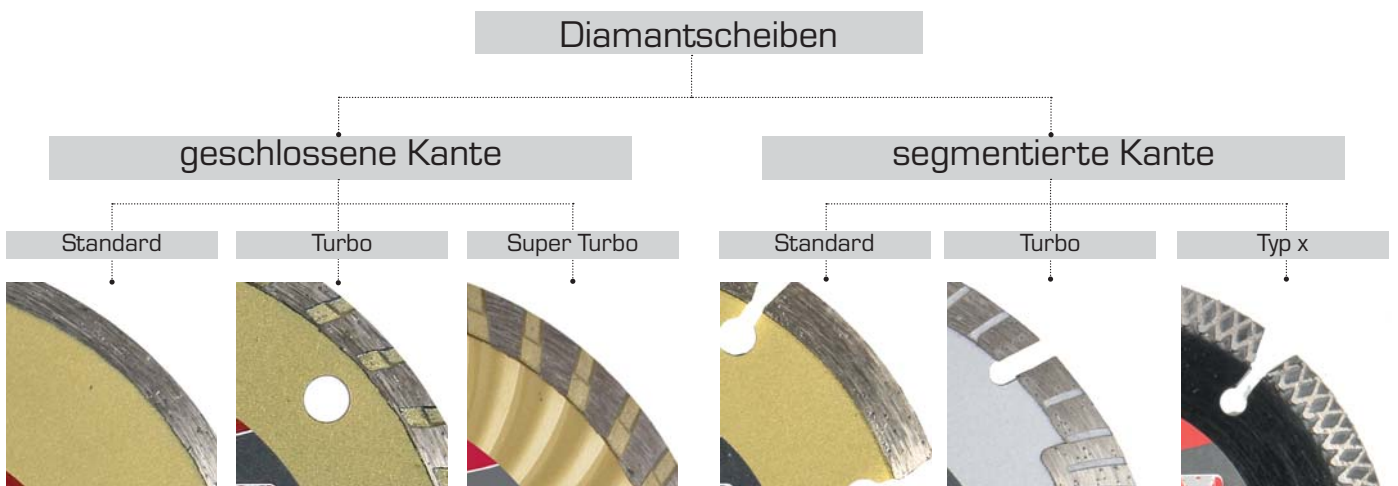





Für die Verbindung des Kerns mit dem Rand verwendete Prozesse:

- Laserschweißen – die stärkste Verbindung,
- Löten – Silberlot wird verwendet, um die Segmente an der Metallscheibe zu befestigen,
- Sintern.

## AUFTEILUNG DER SCHEIBEN















# Primary and optional applications of Proline diamond blades

	code	diamond blade	picture	stone	marble	granite	brick	brick ceramic	porcelain tiles	clinker brick	terracotta	tiles	concrete	reinforced concrete	asphalt	construction	edge
PROLINE	87101-104	continuous		X	O	O	X	X	O	O	O	O	O			sintering	continuous edge
LAHTI PRO	86101-104	segmented		X	X	X	X			O	O	X	O			sintering	segmented
MEGA	88715 - 733	segmented turbo		X	X	X	X	O	O	O	O	X	O			sintering	segmented tubro
JUCO	88101-104	turbo		X	X	X	X	O		O	O	O	X			sintering	turbo with full edge
OTHER BRANDS	88111-114	super turbo		X		X	X	O		O	O	O	X			sintering	turbo with full edge
ERDI	89115 - 350	segmented		X	X	X	X			O	O	X	O	O		laser welded	segmented
	89015 - 033	segmented Type x		X	X	X	X	O	X	O	O	O	X	O	O	laser welded	segmented
KLINGSPOR	89360 - 365	segmented		X	X	X	X			O	O	O	O	O	O	laser welded	segmented
EXPRESS	89370 - 375	segmented		X	X	X	X			O	O	O	X	O		laser welded	segmented
ACTION CAN	89380 - 395	segmented		O	O	O	O			O	O	O	O	O	X	laser welded	segmented
	89415 - 428	for grinding		X	X	X		O		O	O		O			soldered	segmented
TRYTON	89431 - 438	for grinding		X	X	X		O		O	O		O			soldered	segmented
VULCAN	89441 - 448	for grinding		X	X	X		O		O	O		O			soldered	segmented













x - main application  
o - optional application

# Основные и дополнительные виды применения алмазных дисков Proline

код	алмазный диск	рисунок	камень	мрамор	гранит	кирпич	кирпич керамика	керамогранит	клинкерный кирпич	терракота	плитка	бетон	железобетон	асфальт	строительные работы	кромка
87101-104	непрерывная		X	O	O	X	X	O	O	O	O	O			спекание	непрерывная кромка
86101-104	сегментированная		X	X	X	X			O	O		X	O		спекание	сегментированная
88715 - 733	сегментированная турбо		X	X	X	X	O	O	O	O		X	O		спекание	сегментированная турбо
88101-104	турбо		X	X	X	X	O		O	O	O	X			спекание	турбо с полной кромкой
88111-114	супер турбо		X		X	X	O		O	O	O	X			спекание	турбо с полной кромкой
89115 - 350	сегментированная		X	X	X	X			O	O		X	O	O	лазерная сварка	сегментированная
89015 - 033	Типы сегментов		X	X	X	X	O	X	O	O	O	X	O	O	лазерная сварка	сегментированная
89360 - 365	сегментированная		X	X	X	X		O	O	O		O	O	O	лазерная сварка	сегментированная
89370 - 375	сегментированная		X	X	X	X		O	O	O			X	O	лазерная сварка	сегментированная
89380 - 395	сегментированная		O	O	O	O		O	O	O		O	O	X	лазерная сварка	сегментированная
89415 - 428	для шлифования		X	X	X		O		O	O			O		пайка	сегментированная
89431 - 438	для шлифования		X	X	X		O		O	O			O		пайка	сегментированная
89441 - 448	для шлифования		X	X	X		O		O	O			O		пайка	сегментированная

x - основное использование  
o - опциональное использование

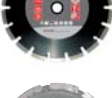
# Primäre und optionale Anwendungen der Diamantscheiben von Proline

Code	Diamantschneide	Bild	Stein	Marmor	Granit	Ziegel	Ziegel aus Keramik	Keramikfliesen	Klinker	Terracotta	Fliesen	Beton	Bewehrter Beton	Asphalt	Konstruktion	Kante
87101-104	geschlossen		X	O	O	X	X	O	O	O	O	O			gesinterte	geschlossene Kante
86101-104	segmentiert		X	X	X	X				O	O	X	O		gesinterte	segmentiert
88715 - 733	segmentiert Turbo		X	X	X	X	O	O	O	O		X	O		gesinterte	segmentiert Tubro
88101-104	Turbo		X	X	X	X	O		O	O	O	X			gesinterte	Turbo mit geschlossener Kante
88111-114	Super Turbo		X		X	X	O		O	O	O	X			gesinterte	Turbo mit geschlossener Kante
89115 - 350	segmentiert		X	X	X	X			O	O		X	O	O	Laser-geschweißt	segmentiert
89015 - 033	segmentiert Typ x		X	X	X	X	O	X	O	O	O	X	O	O	Laser-geschweißt	segmentiert
89360 - 365	segmentiert		X	X	X	X			O	O	O	O	O	O	Laser-geschweißt	segmentiert
89370 - 375	segmentiert		X	X	X	X			O	O	O		X	O	Laser-geschweißt	segmentiert
89380 - 395	segmentiert		O	O	O	O			O	O	O	O	O	X	lasergeschweißt	segmentiert
89415 - 428	zum Schleifen		X	X	X		O		O	O		O			verlötet	segmentiert
89431 - 438	zum Schleifen		X	X	X		O		O	O		O			verlötet	segmentiert
89441 - 448	zum Schleifen		X	X	X		O		O	O		O			verlötet	segmentiert

x - Primäre Verwendung  
o - Optionale Verwendung



**1 CONTINUOUS DIAMOND DISCS**

• АЛМАЗНЫЕ ДИСКИ ПОЛНЫЕ • DIAMANT-SEGMENTSCHLEIBEN



- For wet cutting of: brick, stone, ceramic brick (optional: clinker, marble, gres tiles, granite, tiles)
- Construction: hot pressed

Code	Diameter (mm)	Cutting edge thickness x height (mm)		
87101	115	2.0 x 5.0	x	50/100
87102	125	2.2 x 5.0	x	50/100
87103	180	2.6 x 5.5	x	50
87104	230	2.8 x 5.5	x	25

**4 SEGMENTED DIAMOND DISCS**

• АЛМАЗНЫЕ ДИСКИ СЕГМЕНТНЫЕ • DIAMANT-SEGMENTSCHLEIBEN



- For cutting: marble, brick, stone, granite, concrete (optional: clinker, tiles, reinforced concrete) • Construction: hot pressed

Code	Diameter (mm)	Cutting edge thickness x height (mm)		
86101	115	2.0 x 7.5	x	50/100
86102	125	2.2 x 7.5	x	50/100
86103	180	2.6 x 7.5	x	50
86104	230	2.8 x 7.5	x	25

**2 CONTINUOUS DIAMOND DISCS**

• АЛМАЗНЫЕ ДИСКИ ПОЛНЫЕ • DIAMANT-SEGMENTSCHLEIBEN



- For cutting: marble, brick, stone, granite, concrete (optional: clinker, tiles, ceramic brick) • Construction: hot pressed

Code	Diameter (mm)	Cutting edge thickness x height (mm)		
88101	115	2.0 x 7.5	x	50/100
88102	125	2.4 x 7.5	x	50/100
88103	180	2.7 x 7.5	x	50
88104	230	2.8 x 7.5	x	25

**5 SEGMENTED DIAMOND DISCS**

• АЛМАЗНЫЕ ДИСКИ СЕГМЕНТНЫЕ • DIAMANT-SEGMENTSCHLEIBEN



- For cutting: marble, brick, stone, granite, concrete (optional: clinker, tiles, gres tiles, ceramic brick, reinforced concrete) • Construction: hot pressed

Code	Diameter (mm)	Cutting edge thickness x height (mm)		
88715	115	1.8 x 7.5	x	50/100
88725	125	2.4 x 7.5	x	50/100
88730	180	2.6 x 7.5	x	25/50
88733	230	2.8 x 7.5	x	25

**3 SUPER TURBO DIAMOND DISCS**

• АЛМАЗНЫЕ ДИСКИ SUPER TURBO • DIAMANT-SCHLEIBEN TURBO



- For cutting: marble, brick, stone, granite, concrete (optional: clinker, tiles, ceramic brick) • Construction: hot pressed

Code	Diameter (mm)	Cutting edge thickness x height (mm)		
88111	115	2.0 x 7.5	x	50/100
88112	125	2.4 x 7.5	x	50/100
88113	180	2.7 x 7.5	x	50
88114	230	2.8 x 7.5	x	25

**6 „X” TYPE SEGMENTED DIAMOND DISCS**

• АЛМАЗНЫЕ ДИСКИ СЕГМЕНТНЫЕ ТИПА X • DIAMANT-SEGMENTSCHLEIBEN TYP „X”



- Special segment structure with X pressed shape improves speed and precision of cutting, shortens cooling and improves disc work stability
- For cutting: marble, brick, stone, gres tiles, granite, concrete (optional: clinker, tiles, ceramic brick, asphalt, ceramic tiles, reinforced concrete)
- Construction: laser welded

Code	Diameter (mm)	Cutting edge thickness x height (mm)		
89015	115	2.4 x 7.0	x	50/100
89025	125	2.5 x 7.0	x	50/100
89028	180	2.6 x 7.0	x	25
89033	230	2.8 x 7.0	x	25

PROLINE

LAHTI PRO

MEGA

JUCO

OTHER BRANDS

ERDI

KLINGSPOR

EXPRESS

ACTION CAN

TRAYTON

VULCAN

**1 SEGMENTED DIAMOND DISCS**  
• АЛМАЗНЫЕ СЕГМЕНТНЫЕ ДИСКИ • DIAMANT-SEGMENTSCHLEIBEN



- \*89300, 89350 - opening 25.4 mm
- For cutting: marble, brick, stone, granite, concrete (optional: clinker, tiles, gres tiles, reinforced concrete, asphalt) • Construction: laser welded

Code	Diameter (mm)	Cutting edge thickness x height (mm)		
89115	115	2.0 x 8.0	x	50/100
89125	125	2.1 x 8.3	x	50/100
89180	180	2.2 x 8.5	x	25/50
89230	230	2.5 x 7.1	x	25
89300	300*	2.8 x 8.7	x	10
89350	350*	2.9 x 8.4	x	5/10

**2 SEGMENTED DIAMOND DISCS**  
• АЛМАЗНЫЕ СЕГМЕНТНЫЕ ДИСКИ • DIAMANT-SEGMENTSCHLEIBEN



- For cutting: marble, brick, stone, granite (optional: clinker, tiles, gres tiles, concrete, reinforced concrete, asphalt) • Construction: laser welded

Code	Diameter (mm)	Cutting edge thickness x height (mm)		
89360	300	2.8 x 8.7	x	10
89365	350	2.9 x 8.4	x	10

**3 SEGMENTED DIAMOND DISCS**  
• АЛМАЗНЫЕ СЕГМЕНТНЫЕ ДИСКИ • DIAMANT-SEGMENTSCHLEIBEN



- For cutting: marble, brick, stone, granite, concrete, reinforced concrete (optional: clinker, tiles, gres tiles, asphalt) • Construction: laser welded

Code	Diameter (mm)	Cutting edge thickness x height (mm)		
89370	300	2.8 x 8.7	x	5/10
89375	350	2.9 x 8.4	x	5/10

**4 SEGMENTED DIAMOND DISCS**  
• АЛМАЗНЫЕ СЕГМЕНТНЫЕ ДИСКИ • DIAMANT-SEGMENTSCHLEIBEN



- For cutting: asphalt (optional: clinker, marble, tiles, brick, stone, gres tiles, granite, concrete, reinforced concrete) • Construction: laser welded

Code	Diameter (mm)	Cutting edge thickness x height (mm)		
89380	300	2.8 x 8.7	x	10
89385	350	2.9 x 8.4	x	5/10

**5 GRINDING DIAMOND CUP WHEELS**  
• ТОРЦЕВЫЕ АЛМАЗНЫЕ ЧАШКИ СЕГМЕНТНЫЕ • DIAMANT-SEGMENTSCHLEIFSCHEIBE



- Universal discs for polishing stone, marble, granite, construction materials • Single segment

Code	Diameter (mm)	Segment length x thickness x heightm. (mm)		
89415	115	30 x 6 x 8	x	10/20
89425	125	30 x 6 x 8	x	10/20
89428	180	30 x 6 x 8	x	5/10

**6 GRINDING DIAMOND CUP WHEELS**  
• ТОРЦЕВЫЕ АЛМАЗНЫЕ ЧАШКИ СЕГМЕНТНЫЕ • DIAMANT-SEGMENTSCHLEIFSCHEIBEN



- Universal discs for polishing stone, marble, granite, construction materials • Double segment



Code	Diameter (mm)	Segment length x thickness x heightm. (mm)		
89431	115	30 (20) x 6 x 8	x	10/20
89435	125	30 (20) x 6 x 8	x	10/20
89438	180	30 (20) x 6 x 8	x	5/10

**1 TURBO GRINDING DIAMOND CUP WHEELS**

• ТОРЦЕВЫЕ АЛМАЗНЫЕ ЧАШКИ ДЛЯ ШЛИФОВКИ TURBO • DIAMANT-SCHLEIFSCHEIBEN TURBO



- Universal discs for polishing stone, marble, granite, construction materials

Code	Diameter (mm)	Segment length x thickness x heightm. (mm)		
89441	115	20 x 6 x 8	x	10/20
89445	125	20 x 6 x 8	x	10/20
89448	180	20 x 6 x 8	x	5/10



# PROLINE CIRCULAR SAWS

TOOTH SHAPES USED IN PROLINE CIRCULAR SAW BLADES

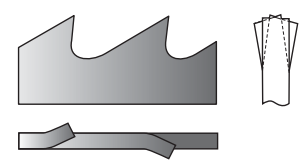
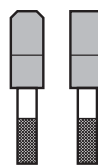
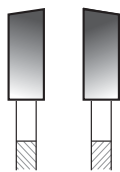

WZ - alternating teeth

TFZ - trapezoidal / flat teeth

KB - alternating teeth

A configuration in which the tooth blades are ground diagonally in alternating directions, once to the right, once to the left.

A tooth grinding in which a slightly trapezoidal tooth follows a slightly lower flat tooth. The higher tooth cuts the material slightly less than the final cutting gap, which prevents damage to the tooth or teeth breaking off in brittle materials

Teeth sharpened and extending to the sides. The teeth are cut using lasers, which assures accurate construction of the saws. The saw blade is made of high-quality steel, which has additionally been tensioned to harden the disc

Universal, for use in soft and hard wood, boards, fibre materials and MDF

Universal, for use in form work and homogeneous materials: composites, laminated particle boards, plastics, plexiglass, non-ferrous metals, brass, copper, hard wood.

Mainly for cross-cutting of soft and hard wood (incl. firewood), designed for work in hand-held and stationary saws.

Exceptionally clean, precise cuts.

Tungsten carbide tipped (TCT) - an inorganic chemical compound containing tungsten and carbon, similar to titanium carbide. It has the highest (6000 °C) boiling point of all known compounds. Due to its high hardness, it is used in cutting tools and smoothing machines as a cheaper and more temperature-resistant alternative to diamonds. Sintered carbides, also known in Poland as „widia” or HM (from the German hartmetall), are used in many industries as components in tools that offer high strength, hardness and abrasion resistance.

PROLINE  
LAHTI PRO  
MEGA  
JUCO  
OTHER BRANDS  
ERDI  
KLINGSPOR  
EXPRESS  
ACTION CAN  
TRYTON  
VULCAN

# КРУГЛЫЕ ПИЛЫ PROLINE

Формы зубьев, используемые в дисковых пилах PROLINE

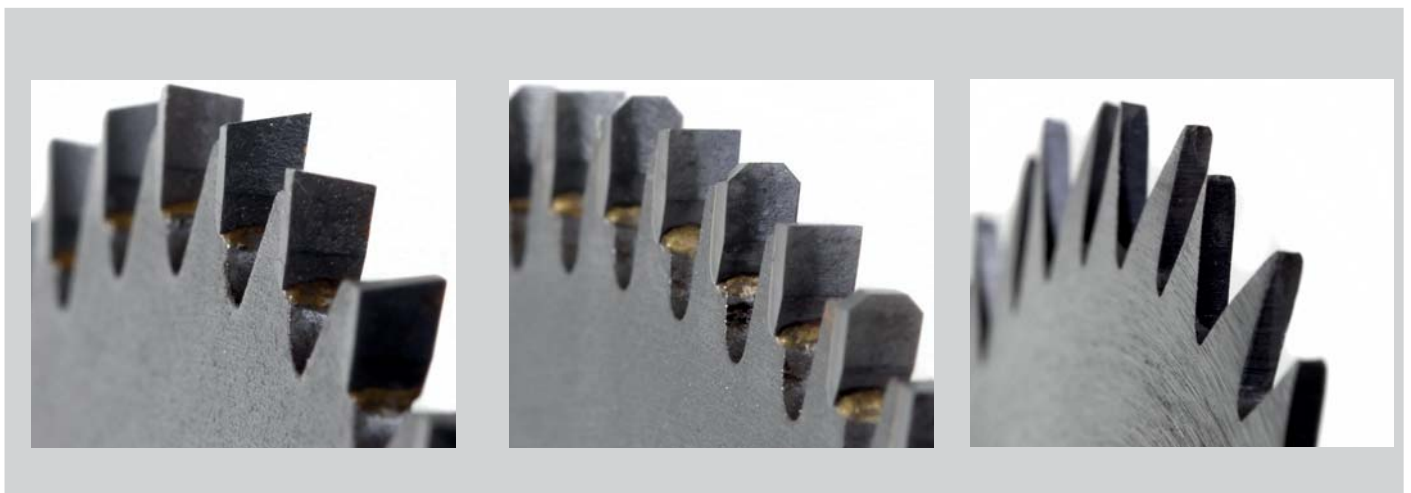
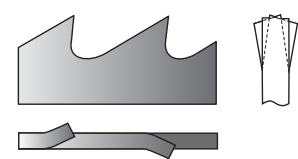
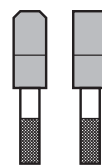
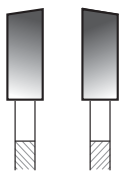

**WZ - чередующиеся зубья**

**TFZ - трапециевидные / плоские зубья**

**KB - чередующиеся зубья**

Конфигурация, в которой зубья заточены по диагонали в чередующихся направлениях, один раз вправо, один раз влево.

Универсальный диск для использования в мягкой и твердой древесине, досках, волокнистых материалах и МДФ

Заточка зубьев, когда слегка трапециевидные зубья следуют за немного более низкими плоскими зубьями. Более высокие зубья режут материал немного меньше, чем последний режущий зазор, что исключает повреждение или разрушение зубьев в хрупких материалах

Универсальный диск для использования в опалубке и однородных материалах: композиты, ламинированные ДСП, пластик, оргстекло, цветные металлы, латунь, медь, твердая древесина.

Зубья заточены и расходятся в стороны. Зубья вырезаются лазером, что обеспечивает точную конструкцию пил. Пильный диск изготовлен из высококачественной стали, в которой было создано дополнительное растягивающее напряжение для упрочнения диска

В основном для распиловки мягкой и твердой древесины (включая дрова), предназначенный для работы с ручными и стационарными пилами.

Равномерный точный распил

Режущая пластина из карбида вольфрама (ТСТ) - неорганическое химическое соединение с содержанием вольфрама и углерода, аналогичное карбиду титана. Имеет наиболее высокую (6000 °С) температуру кипения среди всех известных соединений. Благодаря своей высокой твердости используется в режущих инструментах и шлифовальных станках как более дешевая и более устойчивая к температуре альтернатива алмазам. Спеченные карбиды, также известные в Польше как «widia» или НМ (от немецкого hartmetall), используются во многих отраслях промышленности в качестве компонентов в инструментах, которые обладают высокой прочностью, твердостью и стойкостью к истиранию.

# PROLINE KREISSÄGEBLÄTTER

In PROLINE-Kreissägeblättern verwendete Zahnformen

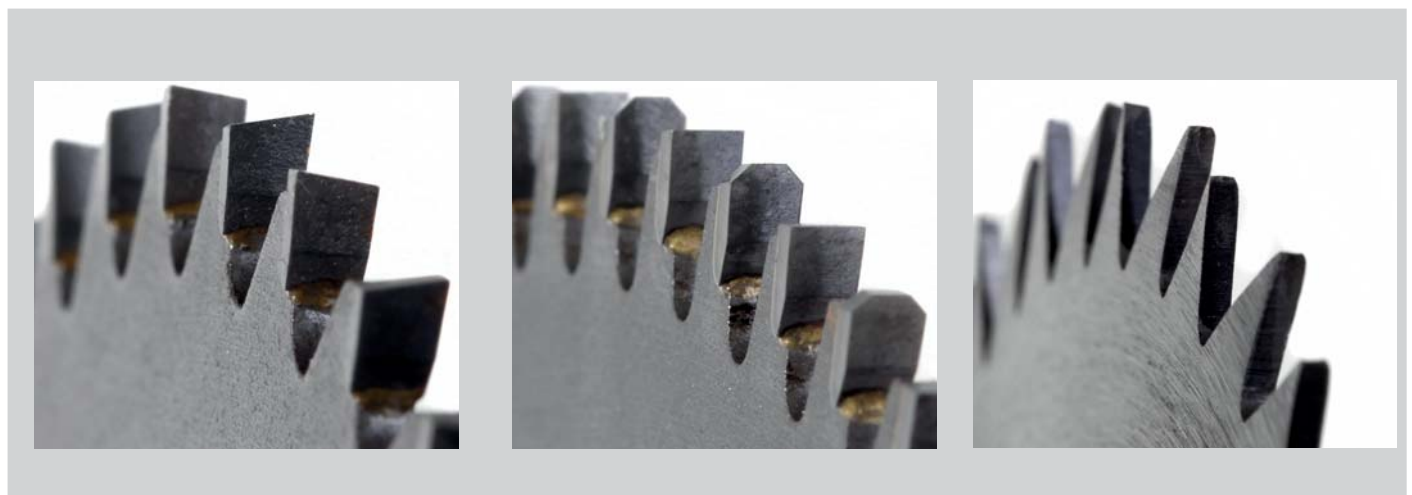
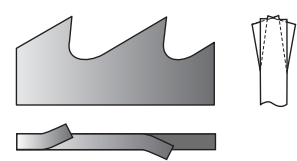
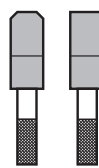
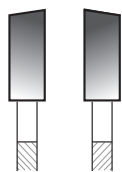

WZ - Wechselzahn

FZ/TR - Trapez-/ Flachzahn

KB - Wechselzahn

Eine Konfiguration, bei der die Zahnklingen diagonal abwechselnd einmal rechts, einmal links geschliffen werden.

Ein Zahnschliff, bei dem ein leicht trapezförmiger Zahn einem etwas niedrigeren Flachzahn folgt. Der höhere Zahn schneidet das Material etwas weniger als der endgültige Schnittspalt, wodurch verhindert wird, dass der Zahn oder die Zähne bei spröden Materialien abbrechen.

Zähne sind auf beiden Seiten geschärft und dehnen sich auf beide Seiten aus. Die Zähne werden mit Lasern geschnitten, was eine genaue Konstruktion der Sägeblätter gewährleistet. Das Sägeblatt besteht aus hochwertigem Stahl, der zusätzlich gespannt wurde, um die Sägeblätter zu härten.

Universell, für den Einsatz in Weich- und Hartholz, Brettern, Fasermaterialien und MDF-Platten.

Universell, für den Einsatz in Formarbeiten und für homogene Materialien: Verbundwerkstoffe, laminierte Spanplatten, Kunststoffe, Plexiglas, eisenfreie Metalle, Messing, Kupfer, Hartholz.

Hauptsächlich für den Querschnitt von Weich- und Hartholz (inkl. Brennholz), ausgelegt für den Betrieb in Handsägen und stationären Sägen.

Besonders saubere und präzise Schnitte.

Tungsten-Carbide-Tipped (TCT) - eine anorganische chemische Verbindung, die Wolfram und Kohlenstoff enthält, ähnlich wie Titancarbid. Es hat den höchsten Siedepunkt (6000 ° C) aller bekannten Verbindungen. Aufgrund seiner hohen Härte wird es in Schneid- und Glättmaschinen als günstigere und temperaturbeständigere Alternative zu Diamanten eingesetzt. Gesinterte Carbide, in Polen auch als „Widia“ oder HM (von Hartmetall) bekannt, werden in vielen Branchen als Komponenten in Werkzeugen eingesetzt, die eine hohe Festigkeit, Härte und Abriebfestigkeit bieten.

**1 SAW BLADES WITH CHAIN FOR ANGLE GRINDERS**

- ЦЕПНЫЕ ОТРЕЗНЫЕ ДИСКИ ДЛЯ УГЛОШЛИФОВАЛЬНЫХ МАШИН
- KETTENRADSCHWEIBEN FÜR SCHLEIFER



- High-speed discs for cutting wood: milling, making furrows, plugging
- Perimeter chain driven with a centrifugal force • Chain can be sharpened

Code	Diameter (mm)	Max. rpm [1/min.]	☒	☐
86011	115	12000	x	50
86012	125	11000	x	50
86023	230	6800	x	10

**2 CIRCULAR SAWS FOR WOOD**

- ПИЛЬНЫЕ ДИСКИ ПО ДЕРЕВУ • KREISSÄGEN FÜR HOLZ

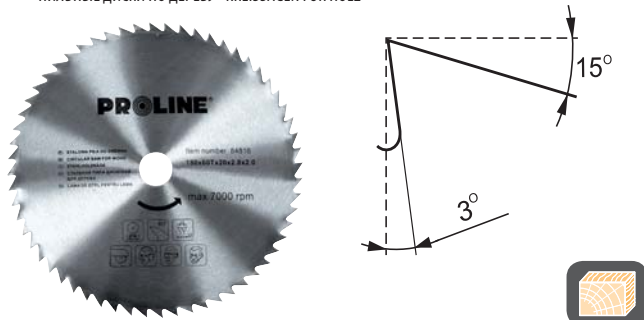

- Quenched and tempered discs • Packed in a box for hanging
- The saws are supplied with rings reducing the diameter of the installation opening

Code	Diameter (mm)	Opening/Reduction	Qty of teeth	☒	☐
84818	180	20/16	60	x	25/50
84820	200	30/20/16	60	x	25/50
84825	250	30/20/16	60	x	10/20
84831	315	30/20/16	80	x	10/20
84835	355	30/20/16	60	x	5/10

**3 CARBIDE TIPPED SAWS FOR NON-FERROUS METALS**

- ПИЛЬНЫЕ ДИСКИ С ТВЕРДОСПЛАВНОЙ НАПАЙКОЙ ПО АЛЮМИНИЮ И СПЛАВАМ
- HM-KREISSÄGEN FÜR NICHT-EISEN-METALLE

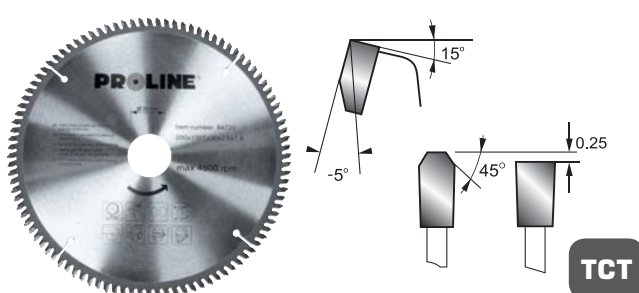

- High quality sintered carbide • Quenched and tempered discs
- For cutting aluminium and its alloys • Packed in a box for hanging
- The saws are supplied with rings reducing the diameter of the installation opening

Code	Diameter (mm)	Opening/Reduction	Qty of teeth	☒	☐
84720	200	30/20/16	100	x	25/50
84721	205	30/20/16	100	x	25/50
84722	210	30/20/16	100	x	25/50
84725	250	30/20/16	100	x	10/20

**4 CARBIDE TIPPED SAWS FOR WOOD**

- ПИЛЬНЫЕ ДИСКИ ПО ДЕРЕВУ С ТВЕРДОСПЛАВНОЙ НАПАЙКОЙ • HMKREISSÄGEN FÜR HOLZ

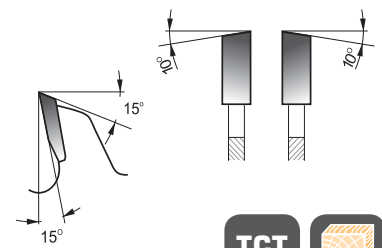

- High quality sintered carbide • Quenched and tempered discs • The saws up to the diameter of 250 mm are supplied with rings reducing the diameter of the installation opening • Packed in a box for hanging

Code	Ø (mm)	Opening/Reduction	Qty of teeth	☒	☐
84132	130	20/16/12.7	24	x	25/50
84133	130	20/16/12.7	30	x	25/50
84141	140	20/16/12.7	16	x	25/50
84142	140	20/16/12.7	24	x	25/50
84152	152	20/16/12.7	24	x	25/50
84161	160	20/16	18	x	25/50
84162	160	20/16	24	x	25/50
84163	160	20/16	30	x	25/50
84164	160	20/16	36	x	25/50
84165	160	20/16	48	x	25/50
84182	184	30/20/16	24	x	25/50
84183	184	30/20/16	36	x	25/50
84184	184	30/20/16	48	x	25/50
84186	184	30/20/16	60	x	25/50
84202	200	30/20/16	24	x	25/50
84204	200	30/20/16	40	x	25/50
84206	200	30/20/16	60	x	25/50
84207	205	30/20/16	24	x	25/50
84208	205	30/20/16	36	x	25/50
84212	210	30/20/16	24	x	25/50
84214	210	30/20/16	40	x	25/50
84216	210	30/20/16	60	x	25/50
84252	250	30/20/16	24	x	10/20
84254	250	30/20/16	40	x	10/20
84256	250	30/20/16	60	x	10/20
84304	300	30	40	x	10/20
84306	300	30	60	x	10/20
84308	300	30	80	x	10/20
84309	300	30	100	x	10/20
84314	315	30	40	x	10/20
84354	350	30	40	x	5/10
84355	350	30	54	x	5/10
84358	350	30	80	x	5/10
84404	400	30	40	x	5/10
84406	400	30	60	x	5/10
84408	400	30	80	x	5/10
84456	450	30	60	x	5
84459	450	30	100	x	5
84506	500	30	60	x	5
84509	500	30	100	x	5

PROLINE  
LAHTI PRO  
MEGA  
JISCO  
OTHER BRANDS  
ENJO  
KILINGSPOR  
EXPRESS  
ACTION SAW  
TRYTON  
VALCAN

# PROLINE CUTTING AND GRINDING DISCS

Discs for cutting or grinding metal and stone are produced using a mixture of several ingredients. The main one is alumina or silicon carbide (SiC). The others are liquid and loose resins, a fibreglass mesh and fillers. The quality of the disc's production is influenced above all by the high-quality abrasive material, high-quality resins and correct reinforcement of the structure in the form of a fibreglass backing. For maximum cutting performance while maintaining user safety, it is advisable to use only cutting and grinding discs with grinders with the same external diameter.

## Type designation

- A** - metal cutting disc. As an abrasive material, alumina (aluminum oxide) was used.
- C** - stone cutting disc. Silicon carbide (SiC) is the abrasive used,
- 60** - grain size (Granulation). The higher the number, the more grains fit on 1 mm<sup>3</sup> of the surface, i.e. the grains are smaller, which in turn means a cleaner cutting surface. The lower grain size means a more aggressive disc, but the edges after cutting will be more jagged.
- S** - hardness of the disc body, which consists of filler and resin. The closer to the end of the Latin alphabet, the harder the disc. **L** to **O** - medium, **P** to **S** - hard, **T** to **W** - very hard

- Disc dimensions in mm:
  - | Outer diameter
  - | X Mounting hole diameter
  - | X disc thickness

- For what material is the disc used
- Permissible operating speeds
- Maximum working speed
- Expiry date:
  - / discs can be used without restrictions up to a given date, e.g.
  - V01/2020 = 1st quarter 2020
  - V04/2020 = 2nd quarter 2020
  - V07/2020 = 3rd quarter 2020
  - V10/2020 = 4th quarter 2020

- Safety pictograms

- Use protective gloves.
- Keep out of reach of children.
- Always use safety goggles!
- Keep out of reach of children. Abrasive product only for dry work. WET GRINDING NOT ALLOWED
- Abrasive product for use only in cutting machines. SURFACE GRINDING NOT ALLOWED

- Description of the disc's purpose in 13 languages
- Manufactured in accordance with the EN12413 standard
- Product code
- Disc shape symbol

## TYPES OF GRINDING DISC SHAPES

<b>41</b> Flat disc	<b>42</b> Depressed centre discs	<b>27</b> Grinding discs with lower center

PROLINE  
LAHTI PRO  
MEGA  
JUCO  
OTHER BRANDS  
ERDI  
KLINGSPOR  
EXPRESS  
ACTION CAN  
TRYTON  
VULCAN



# ОТРЕЗНЫЕ И ШЛИФОВАЛЬНЫЕ ДИСКИ PROLINE

Отрезные или шлифовальные диски для металла и камня производятся с использованием комбинации нескольких материалов. Основным материалом является оксид алюминия или карбид кремния (SiC). Остальные компоненты - жидкие и сыпучие смолы, сетка из стекловолокна и наполнители. На качество изготовления диска влияют, прежде всего, высококачественный абразивный материал, высококачественные смолы и правильное усиление конструкции в виде стекловолоконной основы. Для обеспечения максимальной производительности резки при сохранении безопасности пользователя рекомендуется использовать на станках отрезные и шлифовальные диски только с одинаковым наружным диаметром.

## Обозначение типа

- A** - металлический отрезной диск. В качестве абразивного материала используется оксид алюминия.
- C** - камнерезный диск. Абразивным материалом выступает карбид кремния (SiC),
- 60** - размер зерна (грануляция). Чем больше число, тем больше зерен на 1 мм<sup>3</sup> поверхности, т.е. меньше размер зерна, что, в свою очередь, означает более чистую режущую поверхность. Чем меньше размер зерна, тем более агрессивный диск, но края после резки будут более зазубренными.
- S** - твердость корпуса диска, который состоит из наполнителя и смолы. Чем ближе к концу алфавита буква, тем тверже диск. **L - O** - средней твердости, **P - S** - твердый, **T - W** - очень твердый

## Размер диска в мм:

- | Наружный диаметр
- | X Диаметр установочного отверстия
- | X толщина диска



Описание назначения диска на 13 языках

Для какого материала используется диск

Допустимые рабочие скорости  
Максимальная рабочая скорость

Срок годности:  
Диски можно использовать без ограничения на указанную дату, например,  
V01/2020 = 1. квартал 2020  
V04/2020 = 2. квартал 2020  
V07/2020 = 3. квартал 2020  
V10/2020 = 4. квартал 2020

Предупреждающие знаки

- Использовать защитные перчатки.
- Хранить в недоступном для детей месте.
- Всегда использовать защитные очки!
- Хранить в недоступном для детей месте. Абразивный продукт только для сухой работы. ВЛАЖНАЯ ШЛИФОВКА ЗАПРЕЩЕНА
- Абразивный продукт для использования только на отрезных станках. ШЛИФОВКА ПОВЕРХНОСТИ ЗАПРЕЩЕНА

Изготовлено в соответствии со стандартом EN12413

Код продукта

Символ формы диска

## ВИДЫ ШЛИФОВАЛЬНЫХ ДИСКОВЫХ ПО ФОРМЕ



# PROLINE SCHNEID- UND SCHLEIFSCHEIBEN

Die Schneid- und Schleifscheiben für die Bearbeitung von Metall und Stein werden aus einer Mischung aus verschiedenen Inhaltsstoffen hergestellt. Der Hauptbestandteil ist Korund oder Siliciumcarbid (SiC). Bei den anderen Bestandteilen handelt es sich um flüssige oder lose Harze, ein Glasfasernetz und Füllstoffe. Die Qualität der Produktion der Scheiben wird vor allem durch das hochwertige Schleifmaterial, die hochwertigen Harze und die korrekte Verstärkung der Struktur in Form einer Glasfaserstützscheibe beeinflusst. Für maximale Schneidleistung unter Beibehaltung der Anwendersicherheit wird empfohlen, nur Trenn- und Schleifscheiben mit Maschinen zu verwenden, die den gleichen Außendurchmesser haben.

## Typenbezeichnung

- A** - Trennscheibe für Metall. Als Schleifmaterial wird Korund (Aluminiumoxid) verwendet.
- C** - Trennscheibe für Stein. Als Schleifmaterial wird Siliciumcarbid (SiC) verwendet.
- 60** - Korngröße (Körnung). Je höher die Anzahl, desto mehr Körner passen auf 1 mm<sup>2</sup> der Oberfläche, d. h. die Körner sind kleiner, was wiederum eine sauberere Schneidfläche bedeutet. Eine niedrigere Korngröße bedeutet eine aggressivere Scheibe, aber die Kanten sind nach dem Schneiden rauer.
- S** - Härte des Scheibenkörpers, der aus Füllstoff und Harz besteht. Je näher der Buchstabe am Ende des lateinischen Alphabets liegt, desto härter ist die Scheibe. **L** bis **O** - mittel, **P** bis **S** - hart, **T** bis **W** - sehr hart.

## Scheibenabmessungen in mm:

- X Außendurchmesser
- X Befestigungslochdurchmesser
- X Scheibendicke

## Für welches Material wird die Scheibe verwendet

- Zulässige Betriebsgeschwindigkeiten
- Maximale Arbeitsgeschwindigkeit

Haltbarkeitsdatum:

- Die Scheibe kann ohne Einschränkungen bis zu diesem Datum verwendet werden, z. B.:
  - V01/2020 = 1. Quartal 2020
  - V04/2020 = 2. Quartal 2020
  - V07/2020 = 3. Quartal 2020
  - V10/2020 = 4. Quartal 2020

## Sicherheits-

## Piktogramme

- Sicherheitshandschuhe verwenden.
- Außerhalb der Reichweite von Kindern aufbewahren.
- Immer Schutzbrille verwenden!
- Außerhalb der Reichweite von Kindern aufbewahren. Schleifmittel ausschließlich für trockenes Arbeiten. NASSSCHLEIFEN NICHT ZULÄSSIG
- Schleifmittel nur zur Verwendung in Schneidemaschinen. OBERFLÄCHENSCHLEIFEN NICHT ZULÄSSIG

## Beschreibung des Zwecks der Scheiben in 13 Sprachen

- Hergestellt gemäß der Norm EN12413
- Produktcode
- Symbol der Scheibenform

## ARTEN VON SCHLEIFSCHEIBENFORMEN

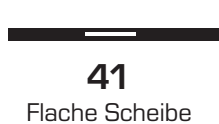

**1 CUTTING DISCS FOR STAINLESS STEEL**

• ОТРЕЗНЫЕ ДИСКИ ДЛЯ РЕЗКИ МЕТАЛЛА, НЕРЖАВЕЮЩЕЙ И КИСЛОТОСТОЙКОЙ СТАЛИ  
• TRENNSCHEIBEN FÜR EDELSTAHL



• Flat disc T41 • For cutting mild steel, aluminium, nonferrous metals, stainless steel, plexiglass

Code	Size (mm)	Opening (mm)	Type	Box
44011	115 x 1.2	22	A60S	25/500
44012	125 x 1.2	22	A60S	25/500
44013	115 x 1.0	22	A60S	25/500
44014	125 x 1.0	22	A60S	25/500
44018	180 x 1.6	22	A36S	10/200
44023	230 x 2.0	22	A36S	10/100
44030	300 x 3.2	32	A24Q	10
44035	350 x 3.5	32	A24Q	10
44040	400 x 4.0	32	A24Q	10

**2 CUTTING DISCS FOR METAL**

• ОТРЕЗНЫЕ ДИСКИ ДЛЯ РЕЗКИ МЕТАЛЛА • TRENNSCHEIBEN FÜR METALLE



• For cutting metal • Flat disc T41

Code	Size (mm)	Opening (mm)	Type	Box
44110	115 x 1.0	22	A60S	25/500
44111	115 x 2.5	22	A30S	25/200
44112	125 x 2.5	22	A30S	25/200
44113	125 x 1.0	22	A60S	25/500
44118	180 x 2.5	22	A30S	10/100
44123	230 x 3.0	22	A30R	10/50

**3 DEPRESSED CUTTING DISCS FOR METAL**

• ОТРЕЗНЫЕ ДИСКИ ДЛЯ РЕЗКИ МЕТАЛЛА, ВЫПУКЛЫЕ • TRENNSCHEIBEN FÜR METALLE, GEWÖLBT



• For cutting metal • Convex disc T42

Code	Size (mm)	Opening (mm)	Type	Box
44211	115 x 2.5	22	A30S	25/200
44212	125 x 2.5	22	A36S	25/200
44223	230 x 3.0	22	A30R	10/50

**4 DEPRESSED GRINDING DISCS FOR METAL**

• ШЛИФОВАЛЬНЫЕ ДИСКИ ДЛЯ МЕТАЛЛА, ВЫПУКЛЫЕ • SCHLEIFSCHEIBEN FÜR METALLE, GEWÖLBT



• For grinding metal • Convex disc T27

Code	Size (mm)	Opening (mm)	Type	Box
44411	115 x 6.0	22	A24R	25/100
44412	125 x 6.0	22	A24R	25/100
44418	180 x 6.0	22	A24R	10/50
44423	230 x 6.0	22	A24R	10/40

**5 CUTTING DISCS FOR STONE**

• ОТРЕЗНЫЕ ДИСКИ ДЛЯ РЕЗКИ КАМНЯ • TRENNSCHEIBEN FÜR STEIN



• For cutting mineral materials • Flat disc T41

Code	Size (mm)	Opening (mm)	Type	Box
44511	115 x 3.0	22	C30R	25/200
44512	125 x 3.0	22	C30S	25/200
44518	180 x 3.0	22	C30S	10/100
44523	230 x 3.0	22	C30S	10/50

**6 DEPRESSED CUTTING DISCS FOR STONE**

• ОТРЕЗНЫЕ ДИСКИ ДЛЯ РЕЗКИ КАМНЯ, ВЫПУКЛЫЕ • TRENNSCHEIBEN FÜR STEIN, GEWÖLBT



• For cutting mineral materials • Convex disc T42

Code	Size (mm)	Opening (mm)	Type	Box
44611	115 x 3.0	22	C30S	25/200
44612	125 x 3.0	22	C30S	25/200
44623	230 x 3.0	22	C30S	10/50

PROLINE  
LAHTI PRO  
MEGA  
JUCO  
OTHER BRANDS  
ERDI  
KLINGSPOR  
EXPRESS  
ACTION CAN  
TRYTON  
VULCAN

**1 CERAMIC GRINDING DISC**

- КЕРАМИЧЕСКИЙ ШЛИФОВАЛЬНЫЙ КРУГ
- KERAMIKSCHLEIFSCHLEIBE



- Grain - 95A alumina. **Use:** for steel, stainless steel, cast iron

Code	Size (mm)	Granulation	Box
44870	125 x 16 x 12,7	60	20
44871	150 x 20 x 12,7	60	20
44872	200 x 20 x 16	60	20
44873	200 x 40 x 20	60	8

- Grain - 98C silicon carbide. **Use:** tungsten-carbide-tipped (TCT), high-speed steel (HSS), non-ferrous metals, ceramics, glass, concrete, stone, hard cast iron.

Code	Size (mm)	Granulation	Box
44874	125 x 16 x 1 2,7	60	20
44875	150 x 20 x 12,7	60	20
44876	200 x 20 x 16	60	20
44877	200 x 40 x 20	60	8

**3 LEAF GRINDING WHEEL**

- ШЛИФОВАЛЬНЫЕ ЛЕПЕСТКОВЫЕ КРУГИ ТОРЦЕВЫЕ
- BLATT-SCHLEIFSCHLEIBE



- Zirconia flap disc grinder • For grinding steel, stainless steel, acid resistant steel, non-ferrous metals, etc. Opening

Code	Diameter (mm)	Granulation	Box
44850	115	40	10/200
44851	115	60	10/200
44852	115	80	10/200
44853	115	120	10/200
44854	125	40	10/200
44855	125	60	10/200
44856	125	80	10/200
44857	125	120	10/200
44858	180	40	10/200
44859	180	60	10/100
44860	180	80	10/100
44861	180	120	10/100

**2 FLAP DISCS**

- ШЛИФОВАЛЬНЫЕ ЛЕПЕСТКОВЫЕ КРУГИ ТОРЦЕВЫЕ (ТИП КЛТ)
- SCHLEIFMOPTELLER



- Flap discs made from abrasive linen with corundum grain, applied evenly on the glass fibre body • **Application:** perfect for machining edges, seams on stainless steel, steel sheets, aluminium, brass, bronze, wood, plastic, paint and lacquer

Code	Size (mm)	Granulation	Box
44801	115	40	10/200
44802	115	60	10/200
44803	115	80	10/200
44804	115	120	10/200
44811	125	40	10/200
44812	125	60	10/200
44813	125	80	10/200
44814	125	120	10/200

**4 FLAP WHEELS**

- ШЛИФОВАЛЬНЫЕ ЛЕПЕСТКОВЫЕ КРУГИ С ОПРАВКОЙ (ТИП КЛО)
- SCHLEIFMOP



- Flap discs made from abrasive linen with corundum grain applied radially • **Application:** cleaning, finish polishing of components with complex shapes

Code	Size (mm)	Granulation	Box
44821	40 x 20	40	250
44822	40 x 20	60	250
44823	40 x 20	80	250
44824	40 x 20	100	250
44825	40 x 20	120	250
44831	60 x 30	40	100
44832	60 x 30	60	100
44833	60 x 30	80	100
44834	60 x 30	100	100
44835	60 x 30	120	100
44841	80 x 30	40	100
44842	80 x 30	60	100
44843	80 x 30	80	100
44844	80 x 30	100	100
44845	80 x 30	120	100

**5 ABRASIVE CLOTH**

- АБРАЗИВНОЕ ПОЛОТНО, РУЛОН
- SCHLEIFLEINEN



- Flexible fabric Type J • Full solid alumina coating • Binder - synthetic resin • **Use:** steel, cast iron, non-ferrous metals, plastics, paints and varnishes, wood

Code	Size (mm)	Granulation	Box
49060	150 x 3000	40	4
49061	150 x 3000	60	4
49062	150 x 3000	80	4
49063	150 x 3000	100	4
49064	150 x 3000	120	4
49065	150 x 3000	240	4
49070	150 x 5000	40	2
49071	150 x 5000	60	2
49072	150 x 5000	80	2
49073	150 x 5000	100	2
49074	150 x 5000	120	2
49075	150 x 5000	240	2
49080	200 x 5000	40	2
49081	200 x 5000	60	2
49082	200 x 5000	80	2
49083	200 x 5000	100	2
49084	200 x 5000	120	2
49085	200 x 5000	240	2

**6 GRINDING DISCS WITH VELCRO**

- АБРАЗИВНЫЕ КРУГИ НА ЛИПУЧКЕ • SCHLEIFSCHLEIBEN MIT KLETTVERSCHLUSS



- Substrate: heavy paper Type E • Normal semi-open alumina coating • Synthetic resin binder • **Use:** wood, plywood, MDF, metal, plastic • Sold in packs of 5 pcs.

Code	Diameter (mm)	Granulation	Box
49130	125 mm	40	180
49131	125 mm	60	180
49132	125 mm	80	180
49133	125 mm	100	180
49134	125 mm	120	180
49135	125 mm	150	240
49136	125 mm	180	240
49137	125 mm	220	240
49138	125 mm	240	240

### 1 GRINDING DISCS WITH VELCRO

- АБРАЗИВНЫЕ КРУГИ НА ЛИПУЧКЕ С ОТВЕРСТИЯМИ
- SCHLEIFSCHEIBEN MIT KLETTVERSCHLUSS



- Substrate: heavy paper Type E. Normal semi-open alumina coating. Synthetic resin binder. **Use:** wood, plywood, MDF, metal, plastic

Code	Diameter (mm)	Granulation	
49140	125	40	180
49141	125	60	180
49142	125	80	180
49143	125	100	180
49144	125	120	180
49145	125	150	240
49146	125	180	240
49147	125	220	240
49148	125	240	240

### 2 DELTA ABRASIVE SHEETS

- АБРАЗИВНЫЕ ЛИСТЫ „DELTA“ НА ЛИПУЧКЕ С ОТВЕРСТИЯМИ
- DELTA-SCHLEIFBLÄTTER



- Substrate: heavy paper Type E • Normal semi-open alumina coating • Synthetic resin binder • **Use:** wood, plywood, MDF, metal, plastic

Code	Size (mm)	Granulation	
49150	93x93	40	320
49151	93x93	60	320
49152	93x93	80	320
49153	93x93	120	320
49154	93x93	240	320

### 3 FIBRE GRINDING DISCS

- ФИБРОВЫЕ АБРАЗИВНЫЕ КРУГИ • FASERSCHLEIFSCHEIBEN



- Substrate - fibre. Coating - normal full alumina. Binder - synthetic resin. **Use:** working metal, removing rust, scales, grinding welds. For angle grinders equipped with a disk for fibre disc pads (Proline, Code-27026)

Code	Diameter (mm)	Granulation	
49160	180	40	8/80
49161	180	60	10/100
49162	180	80	10/100
49163	180	100	12/120
49164	180	120	12/120
49165	180	180	12/120
49166	180	240	12/120

### 4 WATERPROOF SANDPAPER

- ВОДОСТОЙКАЯ АБРАЗИВНАЯ БУМАГА • WASSERDICHTES SCHLEIFPAPIER



- Abrasive paper; waterproof. Substrate latex-backed paper Type A. Full coating - silicon carbide. Synthetic resin binder. **Use:** for wet and dry grinding. For metal surfaces, plastics, paints and varnishes, glass, etc.
- Sold in bulk packs of 50 pieces - Code means 1 item

Code	Dimension (mm)	Granulation	
49100	280 x 230	60	50/500
49101	280 x 230	80	50/500
49102	280 x 230	100	50/500
49103	280 x 230	120	50/500
49104	280 x 230	150	50/500
49105	280 x 230	180	50/1000
49106	280 x 230	220	50/1000
49107	280 x 230	240	50/1000
49108	280 x 230	280	50/1000
49109	280 x 230	320	50/1000
49110	280 x 230	360	50/1000
49111	280 x 230	400	50/1000
49112	280 x 230	500	50/1000
49113	280 x 230	800	50/1000
49114	280 x 230	1200	50/1000
49115	280 x 230	1500	50/1000
49116	280 x 230	2000	50/1000
49117	280 x 230	2500	50/1000

### 5 SANDPAPER

- АБРАЗИВНАЯ БУМАГА В ЛИСТАХ • SCHLEIFPAPIER



- Substrate - paper Type C. Coating - normal solid alumina. Binder - synthetic resin. **Use:** wood, metal, plastics, paints and varnishes, etc. • Sold in bulk packs of 50 pcs - Product code means 1 pc.

Code	Dimension (mm)	Granulation	
49090	280x230	40	50/500
49091	280x230	60	50/500
49092	280x230	80	50/500
49093	280x230	100	50/1000
49094	280x230	120	50/1000
49095	280x230	150	50/1000
49096	280x230	180	50/1000
49097	280x230	220	50/1000
49098	280x230	240	50/1000

### 6 ABRASIVE CLOTH

- АБРАЗИВНОЕ ПОЛОТНО В ЛИСТАХ • SCHLEIFGEWEBE



- Elastic cloth Type J. Normal solid alumina coating. Synthetic resin binder. • **Use:** steel, cast iron, non-ferrous metals, plastics, paints and varnishes, wood. • Sold in bulk packs of 50 pcs - Product code means 1 pc.

Code	Dimension (mm)	Granulation	
49120	280x230	40	50/250
49121	280x230	60	50/500
49122	280x230	80	50/500
49123	280x230	100	50/500
49124	280x230	120	50/500
49125	280x230	180	50/1000
49126	280x230	220	50/1000
49127	280x230	240	50/1000

PROLINE

LANITI PRO

MEGA

JUCO

OTHER BRANDS

ERDI

KLINGSPOR

EXPRESS

ACTION CAN

TRAYTON

VULCAN

### 1 SANDPAPER

• АБРАЗИВНАЯ БУМАГА, РУЛОН • SCHLEIFPAPIER



• Substrate - paper Type D. Coating - normal semi-open alumina. Binder - synthetic resin. Width: 115 mm **Use:** wood, metal, plastics, paints and varnishes, gypsum, plaster, etc.

Code	Length (m)	Granulation	
49040	5	40	50
49041	5	60	50
49042	5	80	50
49043	5	100	50
49044	5	120	50
49045	5	240	50
49046	5	320	50
49050	50	40	4
49051	50	60	4
49052	50	80	4
49053	50	100	4
49054	50	120	4
49055	50	240	4
49056	50	320	4

### 2 ABRASIVE TAPES

• БЕСКОНЕЧНЫЕ АБРАЗИВНЫЕ ЛЕНТЫ • SCHLEIFBÄNDER



x10



• Flexible heavy cloth Type X • Normal full alumina coating. • Synthetic resin binder  
• **Use:** steel, cast iron, non-ferrous metals, plastics and varnishes, wood

Code	Size (mm)	Granulation	
49020	75 x 457	40	40
49021	75 x 457	60	40
49022	75 x 457	80	40
49023	75 x 457	100	40
49024	75 x 457	120	40
49025	75 x 533	40	40
49026	75 x 533	60	40
49027	75 x 533	80	40
49028	75 x 533	100	40
49029	75 x 533	120	40
49030	100 x 610	40	30
49031	100 x 610	60	30
49032	100 x 610	80	30
49033	100 x 610	100	30
49034	100 x 610	120	30

### 3 RUBBER BACKING DISC

• РЕЗИНОВАЯ ОПОРНАЯ ТАРЕЛКА ДЛЯ АБРАЗИВНЫХ КРУГОВ С ХВОСТОВИКОМ • STÜTZTELLER FÜR SCHLEIFSCHEIBEN



• **Application:** as an adapter for a drill on abrasive discs Ø 125 mm

Code	Ø (mm)	Max. rpm [1/min.]		
27034	125	3250	x	100

### 4 BACKING PAD

• ЭЛАСТИЧНЫЕ ОПОРНЫЕ ТАРЕЛКИ ДЛЯ ФИБРОВЫХ АБРАЗИВНЫХ КРУГОВ С ВНУТРЕННЕЙ РЕЗЬБОЙ M14 • STÜTZTELLER FÜR SCHLEIFFIBERSCHEIBEN



• **Application:** as an adapter for an angle grinder on fibre discs Ø 125 mm

Code	Ø (mm)	Max. rpm [1/min.]		
27023	115	10000	x	100
27024	125	10000	x	100
27026	180	6000	x	100

### 5 BACKING PAD

• РЕЗИНОВАЯ ОПОРНАЯ ТАРЕЛКА ДЛЯ АБРАЗИВНЫХ КРУГОВ С ХВОСТОВИКОМ • STÜTZTELLER FÜR SCHLEIFSCHEIBEN



• **Application:** as an adapter for a drill on abrasive discs Ø 125 mm, self-adhesive

Code	Ø (mm)	Max. rpm [1/min.]		
27035	125	3250	x	100

### 6 BACKING PAD

• ЭЛАСТИЧНАЯ ОПОРНАЯ ТАРЕЛКА ДЛЯ АБРАЗИВНЫХ КРУГОВ ВНУТРЕННЕЙ ЕЗЬ • STÜTZTELLER FÜR SCHLEIFSCHEIBEN



• **Application:** as an adapter for an angle grinder on abrasive discs Ø 125 mm, self-adhesive

Code	Ø (mm)	Max. rpm [1/min.]		
27036	125	12500	x	100

### 7 BACKING PAD

• ЭЛАСТИЧНАЯ ОПОРНАЯ ТАРЕЛКА ДЛЯ АБРАЗИВНЫХ КРУГОВ С ВНУТРЕННЕЙ РЕЗЬБОЙ M14 ПЛЮС ПЕРЕХОДНИК-АДАПТОР С ХВОСТОВИКОМ ДЛЯ ДРЕЛИ • STÜTZTELLER FÜR SCHLEIFSCHEIBEN



• **Application:** as an adapter for a drill and angle grinder on abrasive discs Ø 125 mm, self-adhesive

Code	Ø (mm)	Max. rpm [1/min.]		
27037	125	12500	x	100

### 8 BACKING PAD

• ОПОРНАЯ ТАРЕЛКА ДЛЯ АБРАЗИВНЫХ КРУГОВ VELCRO С ВНУТРЕННЕЙ РЕЗЬБОЙ M14 • STÜTZTELLER VERSTÄRKT FÜR SCHLEIFSCHEIBEN



• **Application:** as an adapter for an angle grinder on abrasive discs Ø 125 mm, self-adhesive

Code	Ø (mm)	Max. rpm [1/min.]		
27038	125	12500	x	100

# LAHTI PRO<sup>®</sup>



LAHTIPRO .pl

L

Lahti Pro is a dynamically developing brand of professional clothing and personal protection equipment. Products under this brand are distinguished by their original and fashionable design, high-quality MATERIALS and precise finish. This means anyone looking for professional products that look good and are comfortable will find the right fit in the Lahti Pro range.

Lahti Pro is synonymous with a huge variety of designs, MATERIALS used and, what is very important, collections prepared for various budgets. Starting with basic solutions, through models offering increased functionality and finally, sets designed by Lahti Pro specialists that offer exceptional style and use the latest achievements in MATERIAL technology.

Lahti Pro also includes a wide selection of footwear and gloves. All available models combine extraordinary convenience with durability and resistance to damage, as confirmed by numerous tests.

Lahti Pro has a modern quality control centre. Each product made available for sale passes through a multi-stage testing process that covers the MATERIALS used and the workmanship. Lahti Pro products are made in the world's best textile mills and specialised manufacturing facilities that meet high quality requirements. Every product under the Lahti Pro brand meets the requirements set by occupational health and safety regulations. It has all the necessary certificates and meets the standards for the intended work.

Lahti pro - это динамично развивающаяся марка рабочей одежды и средств индивидуальной защиты. Продукты, обозначенные этой маркой, отличаются оригинальным, модным дизайном, наивысшего качества МАТЕРИАЛАМИ изготовления и точной отделкой. Благодаря этому каждый, кто во время выполнения своих профессиональных обязанностей хочет хорошо и опрятно выглядеть, а также иметь комфорт в работе, найдет в ассортименте Lahti pro те продукты, которые удовлетворят его ожидания.

Lahti pro - это огромное разнообразие узоров, применяемых МАТЕРИАЛОВ, а также, что очень важно, - это коллекции, созданные для потребителей с различными финансовыми возможностями. От базовых решений, через модели с повышенной функциональностью, до проектируемых специалистами Lahti pro комплектов, отличающихся стилистикой и использованием новейших достижений технологий производства МАТЕРИАЛОВ.

Lahti pro - это также богатый выбор обуви и перчаток. Все доступные в продаже модели объединяют необычайно высокое удобство пользования и подтвержденная многочисленными испытаниями прочность и стойкость к повреждениям.

Lahti pro - это современный центр контроля качества. Каждый продукт, позднее доступный в продаже, проходит процесс многоэтапной проверки примененных МАТЕРИАЛОВ и точности выполнения. Изделия Lahti pro создаются на наилучших в мире швейных фабриках и специализированных производственных предприятиях, отвечающих высоким требованиям качества. Каждый продукт марки Lahti pro соответствует требованиям в области безопасности и гигиены труда. Имеет все необходимые сертификаты и отвечает нормам, установленным для тех работ, для которых он предназначен.

Lahti Pro ist eine sich dynamisch entwickelnde Marke für Arbeitskleidung und persönliche Schutzausrüstung. Mit dieser Marke gekennzeichnete Produkte zeichnen sich durch originelles, modisches Design, hochwertige MATERIALIEN und ein präzises Finish aus. Dank dessen kann jeder, der während der Ausübung seiner beruflichen Pflichten Wert auf Ästhetik und Komfort legt, im Sortiment von Lahti Pro Produkte finden, die seine Erwartungen erfüllen.

Bei Lahti Pro handelt es sich um eine Vielzahl von Designs, angewandte MATERIALIEN, und auch, was sehr wichtig ist, Kollektionen, die im Hinblick auf verschiedene finanzielle Möglichkeiten vorbereitet werden. Von Basislösungen über Modelle mit erweiterter Funktionalität bis hin zu Sets, die von Experten von Lahti Pro entworfen wurden, die sich durch ihren Stil auszeichnen und die neuesten Errungenschaften der MATERIAL-Technologie verwenden.

Lahti Pro bietet auch eine große Auswahl an Schuhen und Handschuhen. Alle auf dem Markt verfügbaren Modelle kombinieren einen außergewöhnlichen Benutzungscomfort und haben durch zahlreiche Tests Haltbarkeit und Widerstandsfähigkeit gegenüber Beschädigungen bewiesen.

Lahti Pro ist ein modernes Qualitätskontrollzentrum. Jedes Produkt, das später zum Verkauf angeboten wird, durchläuft einen mehrstufigen Prozess zur Überprüfung der verwendeten MATERIALIEN und der Präzision der Verarbeitung.

Lahti Pro-Produkte werden in den besten Nähräumen der Welt und in spezialisierten Produktionsstätten hergestellt, die den hohen Qualitätsanforderungen entsprechen. Jedes mit der Marke Lahti Pro gekennzeichnete Produkt erfüllt die Anforderungen der Gesundheits- und Sicherheitsvorschriften. Verfügt über alle erforderlichen Zertifikate und erfüllt die Normen für die Arbeiten, für die es bestimmt ist.





# BODY PROTECTION



- bib pants**
- coveralls**
- fleece jackets**
- jackets**
- overalls**
- raincoats**
- socks**
- soft-shell jackets**
- t-shirts**
- trousers**
- vests**
- welding clothes**
- and many others**

**1 PROTECTIVE JACKETS, SLIM FIT**  
 • КУРТКИ ЗАЩИТНЫЕ, SLIM FIT • SICHERHEITS-SWEATSHIRTS, SLIM FIT

270  
g/m<sup>2</sup>



- MATERIAL: 35% cotton, 65% polyester
- 5 pockets, including 3 with zippers. Mobile phone pocket secured with a fabric reflecting electromagnetic radiation. Stretch inserts from a "4-way elastic" fabric (stretches in 4 directions) provide flexibility and comfort during use. Reflective inserts that increase safety during work. Double stitching. Zipper. Sleeves, neck and pockets reinforced with an abrasion-resistant fabric (500D polyester). Bottom of the sweatshirt and sleeves adjustable with Velcro straps. Stylish and interesting design. Slim fit. ID insert.
- NORM: EN ISO 13688

Size	Code	H [cm]	C [cm]	W [cm]	☐
S	L4041001	158-164	84-88	74-78	20
M	L4041002	164-170	92-96	82-86	20
L	L4041003	170-176	100-104	90-94	20
XL	L4041004	176-182	108-112	98-102	20
2XL	L4041005	182-188	116-120	106-110	20
3XL	L4041006	188-194	126-130	116-120	20

PROLINE  
LAHTI PRO  
MEGA  
JUCO  
OTHER BRANDS  
ERDI  
KLINGSPOR  
EXPRESS  
ACTION CAN  
TRYTON  
VULCAN

**1 PROTECTIVE TROUSERS, SLIM FIT**

• БРЮКИ ЗАЩИТНЫЕ ДО ПОЯСА, SLIM FIT • SCHUTZHOSE BIS ZUR TAILLE, SLIM FIT

**270**  
g/m<sup>2</sup>

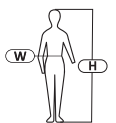
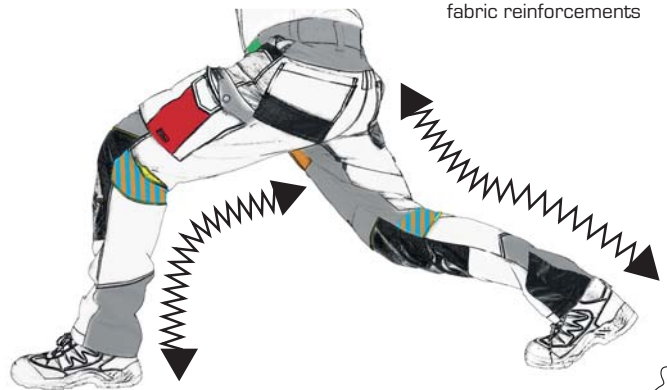
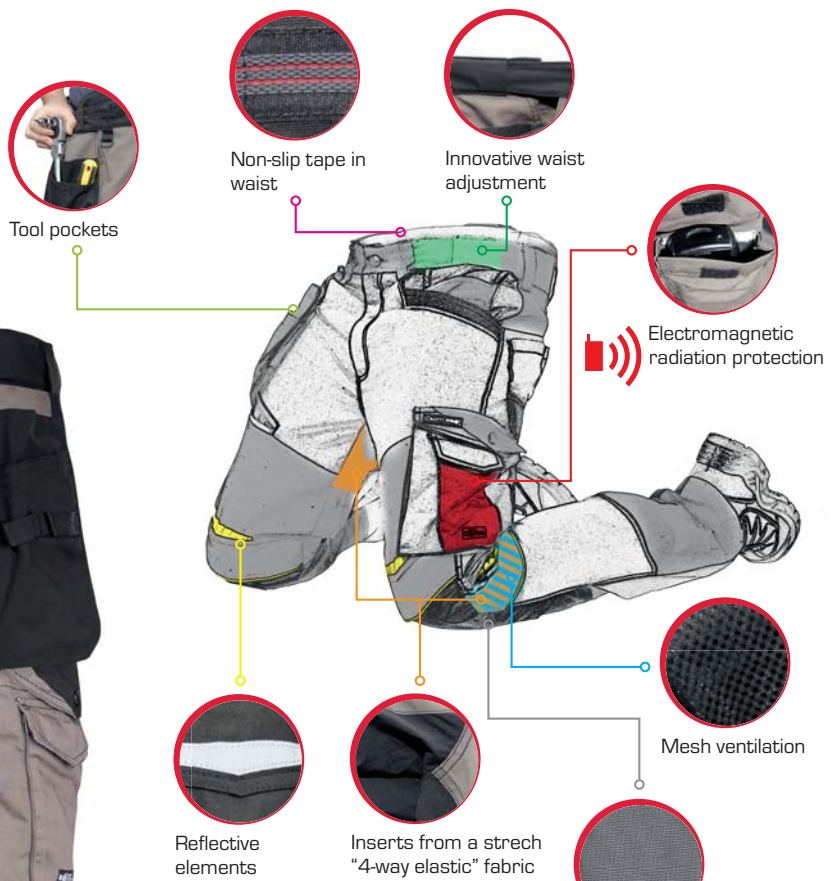
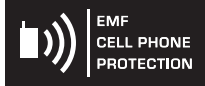

Knee pads for protective trousers and bibpants - see page 398



- MATERIAL: 35% cotton, 65% polyester
- 13 pockets, including 1 with a zipper. Practical tool pockets. Mobile phone pocket secured with a fabric reflecting electromagnetic radiation. Stretch inserts from a "4-way elastic" fabric (stretches in 4 directions) provide flexibility and comfort during use. Mesh ventilation at the knees. Reflective inserts that increase safety during work. Triple-stitched seams. Additional reinforcement of seams in the crotch area. Innovative width adjustment in the waist by means of a special structure with an elastic band. Anti-slip tape at the waist (on the inside) preventing the upper body garment from slipping out of the trousers. Key ring. Loop for a hammer. 3 tape measure holders. Belt loops. Reinforced pockets, knee protector pockets and trouser bottom reinforced with an abrasion-resistant fabric (500D polyester). Slim fit. Stylish and interesting design. ID insert.
- NORM: EN ISO 13688

Size	Code	H (cm)	W (cm)	
S	L4050901	158-164	74-78	20
M	L4050902	164-170	82-86	20
L	L4050903	170-176	90-94	20
XL	L4050904	176-182	98-102	20
2XL	L4050905	182-188	106-110	20
3XL	L4050906	188-194	116-120	20

**1 PROTECTIVE BIB PANTS, SLIM FIT**

• ПОЛУКОМБИНЕЗОНЫ ЗАЩИТНЫЕ, SLIM FIT • SCHUTZ-LATZHOSE, SLIM FIT

**270**  
g/m<sup>2</sup>

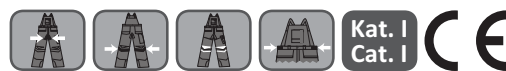
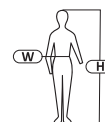
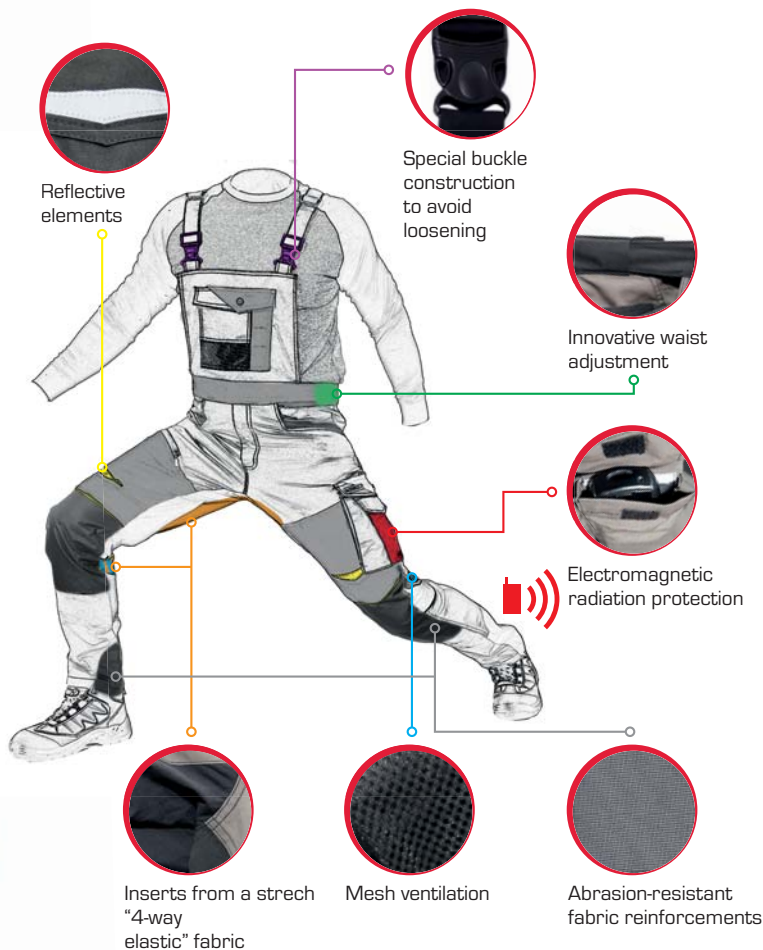
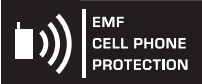

- MATERIAL: 35% cotton, 65% polyester
- 13 pockets, including 1 with a zipper. Practical tool pockets. Mobile phone pocket secured with a fabric reflecting electromagnetic radiation. Stretch inserts from a "4-way elastic" fabric (stretches in 4 directions) provide flexibility and comfort during use. Mesh ventilation at the knees. Reflective inserts that increase safety during work. Triple-stitched seams. Additional reinforcement of seams in the crotch area. Innovative width adjustment in the waist by means of a special structure with an elastic band. Key ring. Loop for a hammer. Length-adjustable braces. Reinforced pockets, knee protector pockets and trouser bottom reinforced with an abrasion-resistant fabric (500D polyester). Slim fit. Stylish and interesting design. ID insert.
- NORM: EN ISO 13688

Size	Code	H [cm]	W [cm]	☐
S	L4060901	158-164	74-78	20
M	L4060902	164-170	82-86	20
L	L4060903	170-176	90-94	20
XL	L4060904	176-182	98-102	20
2XL	L4060905	182-188	106-110	20
3XL	L4060906	188-194	116-120	20

PROLINE

LAHTI PRO

MEGA

JUCO

OTHER BRANDS

ERDI

KLINGSPOR

EXPRESS

ACTION CAN

TRAYTON

VULCAN

Knee pads for protective trousers and bibpant  
- see page 398

**1 JEANS TROUSERS, SLIM FIT**  
 • БРЮКИ ДЖИНСОВЫЕ, SLIM FIT • JEANSHOSE, SLIM FIT

**340**  
g/m<sup>2</sup>



Electromagnetic radiation protection



Innovative waist adjustment



Elastic material with stretch



Abrasion-resistant fabric reinforcements



Knee pads for protective trousers and bibpants  
 - see page 398

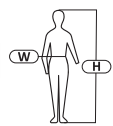

- MATERIAL: 70% cotton, 28% polyester, 2% elastane
- 12 pockets, including 2 with a snap fastener. Mobile phone pocket secured with a fabric reflecting electromagnetic radiation. Stretch fabric provides flexibility and comfort during use. Double stitching. Additional reinforcement of seams in the crotch area. Innovative width adjustment in the waist by means of a special structure with an elastic band. Key ring. Loop for a hammer. Belt loops. Pockets and knee protector pockets reinforced with an abrasion-resistant fabric (600D polyester). Slim fit. Stylish and interesting design. ID insert
- NORM: EN ISO 13688

Size	Code	H [cm]	W [cm]	☐
S	L4051001	158-164	74-78	20
M	L4051002	164-170	82-86	20
L	L4051003	170-176	90-94	20
XL	L4051004	176-182	98-102	20
2XL	L4051005	182-188	106-110	20
3XL	L4051006	188-194	116-120	20



- PROLINE
- LAHTI PRO
- MEGA
- JUCCO
- OTHER BRANDS
- ENDI
- KLINGSPOR
- EXPRESS
- ACTION CAN
- TRYTON
- VILCAN

### 1 PROTECTIVE JACKETS

• КУРТКИ ЗАЩИТНЫЕ • SCHUTZJACKEN

270  
g/m<sup>2</sup>

9 POCKETS



Reflective stripes



9 pockets

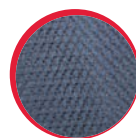

Mesh lining

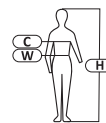

Kat. I  
Cat. I



- MATERIAL: 35% cotton, 65% polyester.
- 9 pockets, including 6 zipped ones. Mobile phone pocket. Zip. Ventilation openings and mesh lining to increase air circulation. Reflective stripes to improve work safety. Jacket sleeves and bottom adjustable with strong Velcros. Fashionable and appealing design. ID insert.
- NORM: EN ISO 13688

Size	Code	H [cm]	C [cm]	W [cm]	☐
S	L4040301	158-164	86-90	80-84	10
M	L4040302	164-170	94-98	86-90	10
L	L4040303	170-176	102-106	92-96	10
XL	L4040304	176-182	110-114	98-102	10
2XL	L4040305	182-188	118-122	104-108	10
3XL	L4040306	188-194	126-130	110-114	10

### 2 PROTECTIVE TROUSERS

• БРЮКИ ЗАЩИТНЫЕ ДО ПОЯСА • SCHUTZBUNDHOSEN

270  
g/m<sup>2</sup>

24 POCKETS

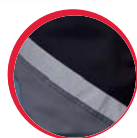
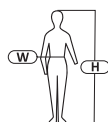

Reflective stripes

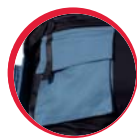

24 pockets



Removable and adjustable tool pockets



Knee pads for protective trousers and bibpants  
- see page 398

Kat. I  
Cat. I



- MATERIAL: 35% cotton, 65% polyester.
- 24 pockets, including 4 zipped ones. Practical tool pockets which can be adjusted and detached. Mobile phone pocket. Ventilation openings in the crotch to increase air circulation. Reflective stripes to improve work safety. Triple seams. Additional strengthening of seams in the crotch. Waist width adjustable with strong Velcros. Key ring. 2 hammer loops. 2 tape measure loops. Pockets for knee pads. Fashionable and appealing design. ID insert.
- NORM: EN ISO 13688

Size	Code	H [cm]	W [cm]	☐
S	L4050201	158-164	80-84	10
M	L4050202	164-170	86-90	10
L	L4050203	170-176	92-96	10
XL	L4050204	176-182	98-102	10
2XL	L4050205	182-188	104-108	10
3XL	L4050206	188-194	110-114	10

### 3 PROTECTIVE BIB PANT

• ПОЛУКОМБИНЕЗОНЫ ЗАЩИТНЫЕ • SCHUTZLATZHOSEN

270  
g/m<sup>2</sup>

18 POCKETS

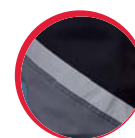
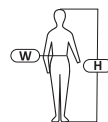

Reflective stripes



18 pockets



Special buckle construction to avoid loosening



Knee pads for protective trousers and bibpants  
- see page 398

Kat. I  
Cat. I



- MATERIAL: 35% cotton, 65% polyester.
- 18 pockets, including 3 zipped ones. Mobile phone pocket. Ventilation openings in the crotch to increase air circulation. Reflective stripes to improve work safety. Triple seams. Additional strengthening of seams in the crotch. Waist width adjustable with buttons and a rubber band. Key ring. 2 hammer loops. 2 tape measure loops. Length-adjustable braces. Pockets for knee pads. Fashionable and appealing design. ID insert.
- NORM/ DIE NORM: EN ISO 13688

Size	Code	H [cm]	W [cm]	☐
S	L4060201	158-164	80-92	10
M	L4060202	164-170	86-96	10
L	L4060203	170-176	92-102	10
XL	L4060204	176-182	98-108	10
2XL	L4060205	182-188	104-114	10
3XL	L4060206	188-194	110-120	10

**1 PROTECTIVE JACKETS**

• КУРТКИ ЗАЩИТНЫЕ • SCHUTZJACKEN

**270**  
g/m<sup>2</sup>

**100%**  
COTTON

**9 POCKETS**



Reflective stripes



9 pockets

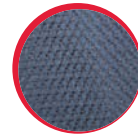

Mesh lining

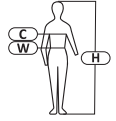

**Kat. I**  
**Cat. I**

- MATERIAL: 100% cotton.
- 9 pockets, including 6 zipped ones. Mobile phone pocket. Zip. Ventilation openings and mesh lining to increase air circulation. Reflective stripes to improve work safety. Jacket sleeves and bottom adjustable with strong Velcros. Fashionable and appealing design. ID insert.
- NORM/ DIE NORM: EN ISO 13688

Size	Code	H (cm)	C (cm)	W (cm)	
S	<b>L4040601</b>	158-164	86-90	80-84	10
M	<b>L4040602</b>	164-170	94-98	86-90	10
L	<b>L4040603</b>	170-176	102-106	92-96	10
XL	<b>L4040604</b>	176-182	110-114	98-102	10
2XL	<b>L4040605</b>	182-188	118-122	104-108	10
3XL	<b>L4040606</b>	188-194	126-130	110-114	10

**2 PROTECTIVE TROUSERS**

• БРЮКИ ЗАЩИТНЫЕ ДО ПОЯСА • SCHUTZBUNDHOSEN

**270**  
g/m<sup>2</sup>

**100%**  
COTTON

**24 POCKETS**

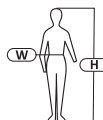

Knee pads for protective trousers and bibpants  
- see page 398



Reflective stripes



24 pockets



Removable and adjustable tool pockets

**Kat. I**  
**Cat. I**

- MATERIAL: 100% cotton.
- 24 pockets, including 4 zipped ones. Practical tool pockets which can be adjusted and detached. Mobile phone pocket. Ventilation openings in the crotch to increase air circulation. Reflective stripes to improve work safety. Triple seams. Additional strengthening of seams in the crotch. Waist width adjustable with strong Velcros. Key ring. 2 hammer loops. 2 tape measure loops. Pockets for knee pads. Fashionable and appealing design. ID insert.
- NORM: EN ISO 13688

Size	Code	H (cm)	W (cm)	
S	<b>L4050501</b>	158-164	80-84	10
M	<b>L4050502</b>	164-170	86-90	10
L	<b>L4050503</b>	170-176	92-96	10
XL	<b>L4050504</b>	176-182	98-102	10
2XL	<b>L4050505</b>	182-188	104-108	10
3XL	<b>L4050506</b>	188-194	110-114	10

**3 PROTECTIVE BIB PANTS**

• ПОЛУКОМБИНЕЗОНЫ ЗАЩИТНЫЕ • SCHUTZBUNDHOSEN

**270**  
g/m<sup>2</sup>

**100%**  
COTTON

**18 POCKETS**

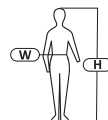

Knee pads for protective trousers and bibpants  
- see page 398



Reflective stripes



18 pockets



Special buckle construction to avoid loosening

**Kat. I**  
**Cat. I**

- MATERIAL: 100% bawełna
- 18 pockets, including 3 zipped ones. Practical tool pockets which can be adjusted and detached. Mobile phone pocket. Ventilation openings in the crotch to increase air circulation. Reflective stripes to improve work safety. Triple seams. Additional strengthening of seams in the crotch. Waist width adjustable with buttons and strong elastic band. Key ring. 2 hammer loops. 2 tape measure loops. Pockets for knee pads. Fashionable and appealing design. ID insert. Length-adjustable braces.
- NORM: EN ISO 13688

Size	Code	H (cm)	W (cm)	
S	<b>L4060501</b>	158-164	80-92	10
M	<b>L4060502</b>	164-170	86-96	10
L	<b>L4060503</b>	170-176	92-102	10
XL	<b>L4060504</b>	176-182	98-108	10
2XL	<b>L4060505</b>	182-188	104-114	10
3XL	<b>L4060506</b>	188-194	110-120	10

**1 PROTECTIVE JACKETS**

• КУРТКИ ЗАЩИТНЫЕ • SICHERHEITS-SWEATSHIRTS

**245**  
g/m<sup>2</sup>



Reflective stripes

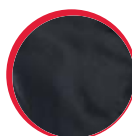

Abrasion-resistant fabric reinforcements

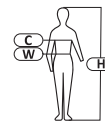

Kat. I  
Cat. I **CE**

- MATERIAL: 35% cotton, 65% polyester
- 4 pockets, including 2 with Velcro straps. Double stitching. Zipper. Reflective strips that improve safety during work. Sleeves reinforced with an abrasion-resistant fabric (600D polyester). Bottom of the jacket and sleeves adjustable with Velcro straps. ID insert.
- NORM: EN ISO 13688

Size	Code	H (cm)	C (cm)	W (cm)	
S	L4040801	158-164	84-88	72-76	10
M	L4040802	164-170	92-96	82-86	10
L	L4040803	170-176	100-104	90-94	10
XL	L4040804	176-182	108-112	98-102	10
2XL	L4040805	182-188	116-120	106-110	10
3XL	L4040806	188-194	126-130	116-120	10

**2 PROTECTIVE TROUSERS**

• БРЮКИ ЗАЩИТНЫЕ ДО ПОЯСА • SCHUTZHOSE BIS ZUR TAILLE

**245**  
g/m<sup>2</sup>

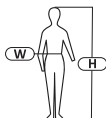

Reflective stripes



Tool pockets



Abrasion-resistant fabric reinforcement



Knee pads for protective trousers and bibpants  
- see page 398

Kat. I  
Cat. I **CE**

- MATERIAL: 35% cotton, 65% polyester
- 16 pockets, including 1 with a Velcro strap. Practical tool pockets. Reflective strips that improve safety during work. Double stitching. Additional reinforcement of seams in the crotch area. Adjustable waist with an elastic band. Key ring. 6 loops for a hammer/measuring tape. Belt loops. Knee protector pockets reinforced with an abrasion-resistant fabric (600D polyester). ID insert
- NORM: EN ISO 13688

Size	Code	H (cm)	W (cm)	
S	L4050701	158-164	72-76	10
M	L4050702	164-170	82-86	10
L	L4050703	170-176	90-94	10
XL	L4050704	176-182	98-102	10
2XL	L4050705	182-188	106-110	10
3XL	L4050706	188-194	116-120	10

**3 PROTECTIVE BIB PANTS**

• ПОЛУКОМБИНЕЗОНЫ ЗАЩИТНЫЕ • SCHUTZLATZHOSE

**245**  
g/m<sup>2</sup>

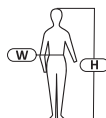

Reflective stripes

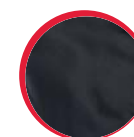

Abrasion-resistant fabric reinforcement



Special buckle construction to avoid loosening



Knee pads for protective trousers and bibpants  
- see page 398

Kat. I  
Cat. I **CE**

- MATERIAL: 35% cotton, 65% polyester
- 12 pockets, including 2 with Velcro straps. Reflective strips that improve safety during work. Double stitching. Additional reinforcement of seams in the crotch area. Adjustable waist with buttons and an elastic band. Key ring. Adjustable-length braces. Knee protector pockets reinforced with an abrasion-resistant fabric (600D polyester). ID insert.
- NORM: EN ISO 13688

Size	Code	H (cm)	W (cm)	
S	L4060701	158-164	72-76	10
M	L4060702	164-170	82-86	10
L	L4060703	170-176	90-94	10
XL	L4060704	176-182	98-102	10
2XL	L4060705	182-188	106-110	10
3XL	L4060706	188-194	116-120	10



**1 PROTECTIVE JACKETS**

• КУРТКИ ЗАЩИТНЫЕ • SCHUTZJACKEN

**267**  
g/m<sup>2</sup>



Abrasion-resistant fabric reinforcement

CERTYFIKAT  
**CIOP - PIB**

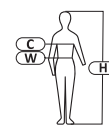

Kat. I  
Cat. I **CE**

- MATERIAL: 35% cotton, 65% polyester.
- 7 pockets, including 4 with Velcro fastening. Mobile phone pocket Zip. Ventilation openings with a mesh, zipped. Sleeves, yoke and pockets strengthened with a fabric (600D polyester). Sleeves ended with flexible cuffs. Width adjustment at the jacket bottom with buttons ID insert.
- NORM: EN ISO 13688

Size	Code	H (cm)	C (cm)	W (cm)		
S (48)	<b>LPBR0148</b>	164-170	88-96	78-84	x	10
M (50)	<b>LPBR0150</b>	170-176	96-104	82-86	x	10
L (52)	<b>LPBR0152</b>	176-182	104-108	84-90	x	10
2L (54)	<b>LPBR0154</b>	176-182	108-116	88-96	x	10
XL (56)	<b>LPBR0156</b>	182-188	116-124	96-102	x	10
3XL (60)	<b>LPBR0160</b>	194-200	124-132	104-110	x	10

**2 PROTECTIVE TROUSERS**

• БРЮКИ ЗАЩИТНЫЕ ДО ПОЯСА • SCHUTZBUNDHOSEN

**267**  
g/m<sup>2</sup>

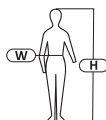

Abrasion-resistant fabric reinforcement



Knee pads for protective trousers and bibpants  
- see page 398

Kat. I  
Cat. I **CE**

- MATERIAL: 35% cotton, 65% polyester.
- 9 pockets, including 6 with Velcro fastening. Mobile phone pocket Triple seams. Waist width adjustment with buttons Key ring. Hammer loop. Pockets and knee pad pockets strengthened with an abrasion-resistant fabric (600D polyester) resistant to chafing.
- NORM: EN ISO 13688

Size	Code	H (cm)	W (cm)		
S (48)	<b>LPSR0148</b>	164-170	78-84	x	10
M (50)	<b>LPSR0150</b>	170-176	82-86	x	10
L (52)	<b>LPSR0152</b>	176-182	84-90	x	10
2L (54)	<b>LPSR0154</b>	176-182	88-96	x	10
XL (56)	<b>LPSR0156</b>	182-188	96-102	x	10
3XL (60)	<b>LPSR0160</b>	194-200	104-110	x	10

**3 PROTECTIVE BIB PANTS**

• ПОЛУКОМБИНЕЗОНЫ ЗАЩИТНЫЕ • SCHUTZLATZHOSEN

**267**  
g/m<sup>2</sup>

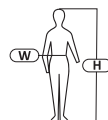

Abrasion-resistant fabric reinforcement



Special buckle construction to avoid loosening



Knee pads for protective trousers and bibpants  
- see page 398

Kat. I  
Cat. I **CE**

- MATERIAL: 35% cotton, 65% polyester.
- 11 pockets, including 7 with Velcro fastening. Mobile phone pocket. Triple seams. Waist width adjustment with buttons and a rubber band. Key ring. Hammer loop. Adjustable braces. Braces, pockets and knee pad pockets strengthened with an abrasion-resistant fabric (600D polyester)
- NORM: EN ISO 13688

Size	Code	H (cm)	W (cm)		
S (48)	<b>LPSR0248</b>	164-170	78-90	x	10
M (50)	<b>LPSR0250</b>	170-176	82-92	x	10
L (52)	<b>LPSR0252</b>	176-182	84-96	x	10
2L (54)	<b>LPSR0254</b>	176-182	88-102	x	10
XL (56)	<b>LPSR0256</b>	182-188	96-108	x	10
3XL (60)	<b>LPSR0260</b>	194-200	104-116	x	10

### 1 PROTECTIVE JACKETS

• КУРТКИ ЗАЩИТНЫЕ • SCHUTZJACKEN

190  
g/m<sup>2</sup>

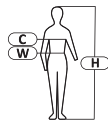

Abrasion-resistant fabric reinforcement

Kat. I  
Cat. I

- MATERIAL: 35% cotton, 65% polyester.
- 7 pockets, including 4 with Velcro fastening. Mobile phone pocket Zip. Ventilation openings to increase air circulation. Sleeves, yoke and pockets strengthened with a fabric (300D polyester) Sleeves adjustable with Velcro. ID insert.
- NORM: EN ISO 13688

Size	Code	H [cm]	C [cm]	W [cm]	
S (48)	L4040448	164-170	88-96	78-84	20
M (50)	L4040450	170-176	96-104	82-86	20
L (52)	L4040452	176-182	104-108	84-90	20
2L (54)	L4040454	176-182	108-116	88-96	20
XL (56)	L4040456	182-188	116-124	96-102	20
3XL (60)	L4040460	194-200	124-132	104-110	20

### 2 PROTECTIVE TROUSERS

• БРЮКИ ЗАЩИТНЫЕ ДО ПОЯСА • SCHUTZJACKEN

190  
g/m<sup>2</sup>

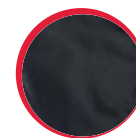
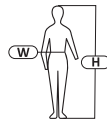

Abrasion-resistant fabric reinforcement

Kat. I  
Cat. I



Knee pads for protective trousers and bibpants  
- see page 398

- MATERIAL: 35% cotton, 65% polyester.
- 7 pockets, including 4 with Velcro fastening. Mobile phone pocket Zip. Ventilation openings to increase air circulation. Sleeves, yoke and pockets strengthened with a fabric (300D polyester). Sleeves adjustable with Velcro. ID insert.
- NORM: EN ISO 13688

Size	Code	H [cm]	W [cm]	
S (48)	L4050348	164-170	78-84	20
M (50)	L4050350	170-176	82-86	20
L (52)	L4050352	176-182	84-90	20
2L (54)	L4050354	176-182	88-96	20
XL (56)	L4050356	182-188	96-102	20
3XL (60)	L4050360	194-200	104-110	20

### 3 PROTECTIVE BIB PANTS

• ПОЛУКОМБИНЕЗОНЫ ЗАЩИТНЫЕ • SCHUTZLATZHOSEN

190  
g/m<sup>2</sup>

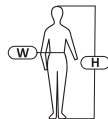

Abrasion-resistant fabric reinforcement



Special buckle construction to avoid self loosening

Kat. I  
Cat. I

- MATERIAL: 35% cotton, 65% polyester.
- 11 pockets, including 7 with Velcro fastening. Mobile phone pocket Triple seams. Waist width adjustment with buttons and a rubber band Key ring. Hammer loop. Adjustable braces Pockets and knee pad pockets strengthened with an abrasion-resistant fabric (300D polyester).
- NORM: EN ISO 13688

Size	Code	H [cm]	W [cm]	
S (48)	L4060348	164-170	78-90	20
M (50)	L4060350	170-176	82-92	20
L (52)	L4060352	176-182	84-96	20
2L (54)	L4060354	176-182	88-102	20
XL (56)	L4060356	182-188	96-108	20
3XL (60)	L4060360	194-200	104-116	20

### 4 PROTECTIVE COVERALLS

• КОМБИНЕЗОНЫ ЗАЩИТНЫЕ • SCHUTZCOVERALLS

190  
g/m<sup>2</sup>

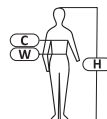

Abrasion-resistant fabric reinforcement

Kat. I  
Cat. I



Knee pads for protective trousers and bibpants  
- see page 398

- MATERIAL: 35% cotton, 65% polyester.
- 11 pockets, including 7 with Velcro fastening. Mobile phone pocket Two-way zip. Ventilation openings to increase air circulation. Sleeves adjustable with Velcro Triple seams. Waist width adjustment with a rubber band. Key ring. Hammer loop. Sleeves, yoke, pockets and knee pad pockets strengthened with an abrasion-resistant fabric (300D polyester) resistant to chafing. ID insert.
- NORM: EN ISO 13688

Size	Code	H [cm]	C [cm]	W [cm]	
S (48)	L4150148	164-170	88-96	78-84	20
M (50)	L4150150	170-176	96-104	82-86	20
L (52)	L4150152	176-182	104-108	84-90	20
2L (54)	L4150154	176-182	108-116	88-96	20
XL (56)	L4150156	182-188	116-124	96-102	20
3XL (60)	L4150160	194-200	124-132	104-110	20

**1 PROTECTIVE JACKETS**

• КУРТКИ ЗАЩИТНЫЕ • SCHUTZJACKEN

**270**  
g/m<sup>2</sup>  
**100%**  
COTTON



Abrasion-resistant fabric reinforcement

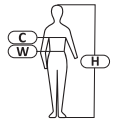

**Kat. I**  
**Cat. I**

- MATERIAL: 100% cotton.
- 7 pockets, including 4 with Velcro fastening. Mobile phone pocket. Zip. Ventilation openings with a mesh, zipped. Reflective components. Sleeves, yoke and pockets strengthened with an abrasion-resistant fabric (600D polyester). Sleeves with Velcro adjustment. Width adjustment at the jacket bottom with buttons. ID insert.
- NORM: EN ISO 13688

Size	Code	H (cm)	C (cm)	W (cm)		
S (48)	<b>L4040148</b>	164-170	88-96	78-84	x	10
M (50)	<b>L4040150</b>	170-176	96-104	82-86	x	10
L (52)	<b>L4040152</b>	176-182	104-108	84-90	x	10
2L (54)	<b>L4040154</b>	176-182	108-116	88-96	x	10
XL (56)	<b>L4040156</b>	182-188	116-124	96-102	x	10
3XL (60)	<b>L4040160</b>	194-200	124-132	104-110	x	10

**2 PROTECTIVE TROUSERS**

• БРЮКИ ЗАЩИТНЫЕ ДО ПОЯСА • SCHUTZBUNDHOSEN

**270**  
g/m<sup>2</sup>  
**100%**  
COTTON

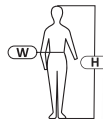

Abrasion-resistant fabric reinforcement

Knee pads for protective trousers and bibpants - see page 398

**Kat. I**  
**Cat. I**

- MATERIAL: 100% cotton.
- 9 pockets, including 6 with Velcro fastening. Mobile phone pocket. Triple seams. Waist width adjustment with buttons. Key ring. Hammer loop. Pockets and knee pad pockets strengthened with an abrasion-resistant fabric (600D polyester). ID insert.
- NORM: EN ISO 13688

Size	Code	H (cm)	W (cm)		
S (48)	<b>L4050148</b>	164-170	78-84	x	10
M (50)	<b>L4050150</b>	170-176	82-86	x	10
L (52)	<b>L4050152</b>	176-182	84-90	x	10
2L (54)	<b>L4050154</b>	176-182	88-96	x	10
XL (56)	<b>L4050156</b>	182-188	96-102	x	10
3XL (60)	<b>L4050160</b>	194-200	104-110	x	10

**3 PROTECTIVE BIB PANTS**

• ПОЛУКОМБИНЕЗОНЫ ЗАЩИТНЫЕ • SCHUTZLATZHOSEN

**270**  
g/m<sup>2</sup>  
**100%**  
COTTON

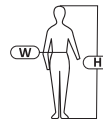

Abrasion-resistant fabric reinforcement



Special buckle construction to avoid loosening

Knee pads for protective trousers and bibpants - see page 398

**Kat. I**  
**Cat. I**

- MATERIAL: 100% cotton.
- 10 pockets, including 6 with Velcro fastening. Mobile phone pocket. Triple seams. Waist width adjustment with buttons and a rubber band. Key ring. Hammer loop. Reflective components. Adjustable braces. Braces, pockets and knee pad pockets strengthened with an abrasion-resistant fabric (600D polyester). ID insert.
- NORM: EN ISO 13688

Size	Code	H (cm)	W (cm)		
S (48)	<b>L4060148</b>	164-170	78-90	x	10
M (50)	<b>L4060150</b>	170-176	82-92	x	10
L (52)	<b>L4060152</b>	176-182	84-96	x	10
2L (54)	<b>L4060154</b>	176-182	88-102	x	10
XL (56)	<b>L4060156</b>	182-188	96-108	x	10
3XL (60)	<b>L4060160</b>	194-200	104-116	x	10

### 1 PROTECTIVE JACKETS

• КУРТКИ ЗАЩИТНЫЕ • SCHUTZJACKEN

270  
g/m<sup>2</sup>

100%  
COTTON



Abrasion-resistant  
fabric reinforcement

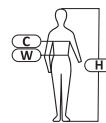

Kat. I  
Cat. I **CE**

- MATERIAL: 100% cotton.
- 7 pockets, including 4 with Velcro fastening. Mobile phone pocket. Zip. Ventilation openings with a mesh, zipped. Reflective components. Sleeves, yoke and pockets strengthened with (600D polyester). Sleeves with Velcro adjustment. Width adjustment at the jacket bottom with buttons. ID insert.
- NORM: EN ISO 13688

Size	Code	H (cm)	C (cm)	W (cm)		
S (48)	<b>L4040748</b>	164-170	88-96	78-84	x	10
M (50)	<b>L4040750</b>	170-176	96-104	82-86	x	10
L (52)	<b>L4040752</b>	176-182	104-108	84-90	x	10
2L (54)	<b>L4040754</b>	176-182	108-116	88-96	x	10
XL (56)	<b>L4040756</b>	182-188	116-124	96-102	x	10
3XL (60)	<b>L4040760</b>	194-200	124-132	104-110	x	10

### 2 PROTECTIVE TROUSERS

• БРЮКИ ЗАЩИТНЫЕ ДО ПОЯСА • SCHUTZBUNDHOSEN

270  
g/m<sup>2</sup>

100%  
COTTON

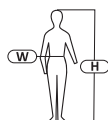

Abrasion-resistant  
fabric reinforcement



Knee pads for  
protective trousers and  
bibpants  
- see page 398

Kat. I  
Cat. I **CE**

- MATERIAL: 100% cotton.
- 9 pockets, including 6 with Velcro fastening. Mobile phone pocket. Triple seams. Waist width adjustment with buttons. Key ring. Hammer loop. Pockets and knee pad pockets strengthened with an abrasion-resistant fabric (600D polyester). ID insert.
- NORM: EN ISO 13688

Size	Code	H (cm)	W (cm)		
S (48)	<b>L4050648</b>	164-170	78-84	x	10
M (50)	<b>L4050650</b>	170-176	82-86	x	10
L (52)	<b>L4050652</b>	176-182	84-90	x	10
2L (54)	<b>L4050654</b>	176-182	88-96	x	10
XL (56)	<b>L4050656</b>	182-188	96-102	x	10
3XL (60)	<b>L4050660</b>	194-200	104-110	x	10

### 3 PROTECTIVE BIB PANTS

• ПОЛУКМБИНЕЗОНЫ ЗАЩИТНЫЕ • SCHUTZLATZHOSEN

270  
g/m<sup>2</sup>

100%  
COTTON

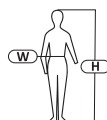

Abrasion-resistant  
fabric reinforcement



Special buckle  
construction  
to avoid  
loosening



Knee pads for  
protective trousers and  
bibpants  
- see page 398

Kat. I  
Cat. I **CE**

- MATERIAL: 100% cotton.
- 10 pockets, including 6 with Velcro fastening. Mobile phone pocket. Triple seams. Waist width adjustment with buttons and a rubber band. Key ring. Hammer loop. Reflective components. Adjustable braces. Braces, pockets and knee pad pockets strengthened with an abrasion-resistant fabric (600D polyester). ID insert.
- NORM: EN ISO 13688

Size	Code	H (cm)	W (cm)		
S (48)	<b>L4060648</b>	164-170	78-90	x	10
M (50)	<b>L4060650</b>	170-176	82-92	x	10
L (52)	<b>L4060652</b>	176-182	84-96	x	10
2L (54)	<b>L4060654</b>	176-182	88-102	x	10
XL (56)	<b>L4060656</b>	182-188	96-108	x	10
3XL (60)	<b>L4060660</b>	194-200	104-116	x	10

**1 PROTECTIVE JACKETS**

• КУРТКИ ЗАЩИТНЫЕ • SCHUTZJACKEN

**190**  
g/m<sup>2</sup>

**100%**  
COTTON

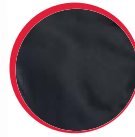

Abrasion-resistant fabric reinforcement

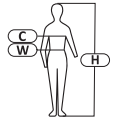

**Kat. I**  
**Cat. I** **CE**

- MATERIAL: 100% cotton.
- 7 pockets, including 4 with Velcro fastening. Mobile phone pocket. Zip. Ventilation openings to increase air circulation. Sleeves, yoke and pockets strengthened with an abrasion-resistant fabric (300D polyester). Sleeves adjustable with Velcro. ID insert.
- NORM: EN ISO 13688

Size	Code	H (cm)	C (cm)	W (cm)	☐
S (48)	<b>L4040548</b>	164-170	88-96	78-84	20
M (50)	<b>L4040550</b>	170-176	96-104	82-86	20
L (52)	<b>L4040552</b>	176-182	104-108	84-90	20
2L (54)	<b>L4040554</b>	176-182	108-116	88-96	20
XL (56)	<b>L4040556</b>	182-188	116-124	96-102	20
3XL (60)	<b>L4040560</b>	194-200	124-132	104-110	20

**2 PROTECTIVE TROUSERS**

• БРЮКИ ЗАЩИТНЫЕ ДО ПОЯСА • SCHUTZBUNDHOSEN

**190**  
g/m<sup>2</sup>

**100%**  
COTTON

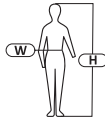

Abrasion-resistant fabric reinforcement



Knee pads for protective trousers and bibpants - see page 398

**Kat. I**  
**Cat. I** **CE**

- MATERIAL: 100% cotton.
- 9 pockets, including 6 with Velcro fastening. Mobile phone pocket. Triple seams. Waist width adjustable with buttons. Key ring. Hammer loop. Pockets and knee pad pockets strengthened with an abrasion-resistant fabric (300D polyester).
- NORM: EN ISO 13688

Size	Code	H (cm)	W (cm)	☐
S (48)	<b>L4050448</b>	164-170	78-84	20
M (50)	<b>L4050450</b>	170-176	82-86	20
L (52)	<b>L4050452</b>	176-182	84-90	20
2L (54)	<b>L4050454</b>	176-182	88-96	20
XL (56)	<b>L4050456</b>	182-188	96-102	20
3XL (60)	<b>L4050460</b>	194-200	104-110	20

**3 PROTECTIVE BIB PANTS**

• ПОЛУКОМБИНЕЗОНЫ ЗАЩИТНЫЕ • SCHUTZLATZHOSEN

**190**  
g/m<sup>2</sup>

**100%**  
COTTON

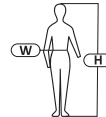

Abrasion-resistant fabric reinforcement



Special buckle construction to avoid self loosening



Knee pads for protective trousers and bibpants - see page 398

**Kat. I**  
**Cat. I** **CE**

- MATERIAL: 100% cotton.
- 11 pockets, including 7 with Velcro fastening. Mobile phone pocket. Triple seams. Waist width adjustable with buttons and a rubber band. Key ring. Hammer loop. Adjustable braces. Pockets and knee pad pockets strengthened with an abrasion-resistant fabric (300D polyester).
- NORM: EN ISO 13688

Size	Code	H (cm)	W (cm)	☐
S (48)	<b>L4060448</b>	164-170	78-90	20
M (50)	<b>L4060450</b>	170-176	82-92	20
L (52)	<b>L4060452</b>	176-182	84-96	20
2L (54)	<b>L4060454</b>	176-182	88-102	20
XL (56)	<b>L4060456</b>	182-188	96-108	20
3XL (60)	<b>L4060460</b>	194-200	104-116	20

**1 PROTECTIVE JACKETS**

• КУРТКИ ЗАЩИТНЫЕ • SCHUTZJACKEN

**245**  
g/m<sup>2</sup>



Allton

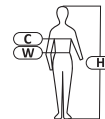

Kat. I  
Cat. I CE

- MATERIAL: 35% cotton, 65% polyester.
- 5 pockets, including 3 with Velcro fastening. Mobile phone pocket. Triple seams. Zip. Width adjustment at the jacket bottom, with snap fasteners. Cuffs fastened with snap fasteners, enabling adjustment. Contrasting seams, emphasizing the precision of finish. ID insert.
- NORM: EN ISO 13688

Size	Code	H (cm)	C (cm)	W (cm)	☐
S	LPAB64S	164	84-88	72-76	10
M	LPAB70M	170	92-96	82-86	10
M	LPAB76M	176	92-96	82-86	10
L	LPAB76L	176	100-104	90-94	10
L	LPAB82L	182	100-104	90-94	10
L	LPAB88L	188	100-104	90-94	10
XL	LPAB76XL	176	108-112	98-102	10
XL	LPAB82XL	182	108-112	98-102	10
XL	LPAB88XL	188	108-112	98-102	10
2XL	LPAB822XL	182	116-120	106-110	10
2XL	LPAB882XL	188	116-120	106-110	10
3XL	LPAB943XL	194	126-130	116-120	10

**2 PROTECTIVE TROUSERS**

• БРЮКИ ЗАЩИТНЫЕ ДО ПОЯСА • SCHUTZBUNDHOSEN

**245**  
g/m<sup>2</sup>

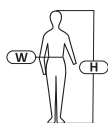

Allton



Knee pads for protective trousers and bibpants  
- see page 398

Kat. I  
Cat. I CE

- MATERIAL: 35% cotton, 65% polyester.
- 5 pockets, including 2 with Velcro fastening. Double seams. Waist width adjustment with a rubber band. Key ring. Knee pad pockets with Velcro fastening. Contrasting seams, emphasizing the precision of finish. ID insert.
- NORM: EN ISO 13688

Size	Code	H (cm)	W (cm)	☐
S	LPAS64S	164	72-76	10
M	LPAS70M	170	82-86	10
M	LPAS76M	176	82-86	10
L	LPAS76L	176	90-94	10
L	LPAS82L	182	90-94	10
L	LPAS88L	188	90-94	10
XL	LPAS76XL	176	98-102	10
XL	LPAS82XL	182	98-102	10
XL	LPAS88XL	188	98-102	10
2XL	LPAS822XL	182	106-110	10
2XL	LPAS882XL	188	106-110	10
3XL	LPAS943XL	194	116-120	10

**3 PROTECTIVE BIB PANTS**

• ПОЛУКОМБИНЕЗОНЫ ЗАЩИТНЫЕ • SCHUTZLATZHOSEN

**245**  
g/m<sup>2</sup>

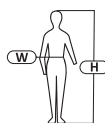

Allton



Special buckle construction to avoid self loosening



Knee pads for protective trousers and bibpants  
- see page 398

Kat. I  
Cat. I CE

- MATERIAL: 35% cotton, 65% polyester.
- 7 pockets, including 4 with Velcro fastening. Mobile phone pocket. Double seams. Waist width adjustment with buttons and a rubber band. Key ring. Braces adjustable with a fastener and a rubber band. Knee pad pockets with Velcro fastening. Contrasting seams, emphasizing the precision of finish. ID insert.
- NORM: EN ISO 13688

Size	Code	H (cm)	W (cm)	☐
S	LPA064S	164	72-76	10
M	LPA070M	170	82-86	10
M	LPA076M	176	82-86	10
L	LPA076L	176	90-94	10
L	LPA082L	182	90-94	10
L	LPA088L	188	90-94	10
XL	LPA076XL	176	98-102	10
XL	LPA082XL	182	98-102	10
XL	LPA088XL	188	98-102	10
2XL	LPA0822XL	182	106-110	10
2XL	LPA0882XL	188	106-110	10
3XL	LPA0943XL	194	116-120	10

**1 PROTECTIVE VESTS**

• ЖИЛЕТЫ ЗАЩИТНЫЕ • SCHUTZWESTEN

Allton

245 g/m<sup>2</sup>

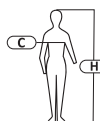

Kat. I  
Cat. I CE

- MATERIAL: 35% cotton, 65% polyester.
- 8 pockets, including 2 zipped ones. Mobile phone pocket. Zip. Key ring. Tape measure loop. Mesh lining. Contrasting seams, emphasizing the precision of finish. ID insert.
- NORM: EN ISO 13688

Size	Code	H (cm)	C (cm)	
S	LPAK1S	158-164	84-88	20
M	LPAK1M	164-170	92-96	20
L	LPAK1L	170-176	100-104	20
XL	LPAK1XL	176-182	108-112	20
2XL	LPAK12XL	182-188	116-120	20
3XL	LPAK13XL	188-194	126-130	20

**2 PROTECTIVE SHORTS**

• ШОРТЫ ЗАЩИТНЫЕ КОРОТКИЕ • SCHUTZHOSEN KURZ

Allton

245 g/m<sup>2</sup>

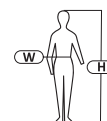

Kat. I  
Cat. I CE

- MATERIAL: 35% cotton, 65% polyester.
- 7 pockets, including 4 with Velcro fastening. Mobile phone pocket. Double seams. Width adjustment with a rubber band. Key ring. Narrow side pocket. Contrasting seams, emphasizing the precision of finish. ID insert.
- NORM: EN ISO 13688

Size	Code	H (cm)	W (cm)	
S	LPAS1S	158-164	72-76	20
M	LPAS1M	164-170	82-86	20
L	LPAS1L	170-176	90-94	20
XL	LPAS1XL	176-182	98-102	20
2XL	LPAS12XL	182-188	106-110	20
3XL	LPAS13XL	188-194	116-120	20

**3 PROTECTIVE CROPPED PANTS**

• БРЮКИ-КАПРИ ЗАЩИТНЫЕ • SCHUTZHOSEN 3/4

Allton

245 g/m<sup>2</sup>



Adjustable width of the leg bottom with a special drawstring.

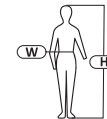

Kat. I  
Cat. I CE

- MATERIAL: 35% cotton, 65% polyester.
- 7 pockets, including 4 with Velcro fastening. Mobile phone pocket. Double seams. Width adjustment with a rubber band. Width adjustment at the pants' bottom with a special drawstring. Key ring. Contrasting seams, emphasizing the precision of finish. ID insert.
- NORM: EN ISO 13688

Size	Code	H (cm)	W (cm)	
S	L1714012	158-164	72-76	20
M	L1714013	164-170	82-86	20
L	L1714014	170-176	90-94	20
XL	L1714015	176-182	98-102	20
2XL	L1714016	182-188	106-110	20
3XL	L1714017	188-194	116-120	20

**1 PROTECTIVE SHORTS**

• ШОРТЫ ЗАЩИТНЫЕ КОРОТКИЕ • SCHUTZHOSEN KURZ

245 g/m<sup>2</sup>

100% COTTON

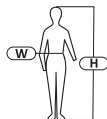

Kat. I  
Cat. I



- MATERIAL: 100% cotton.
- 10 pockets, including 4 with Velcro fastening. Mobile phone pocket. Double seams. Waist width adjustment with a rubber band. Key ring. Hammer loop. Tape measure loop. Narrow side pocket. ID insert.
- NORM: EN ISO 13688

Size	Code	H (cm)	W (cm)	☐
S	L4070401	158-164	72-76	20
M	L4070402	164-170	82-86	20
L	L4070403	170-176	90-94	20
XL	L4070404	176-182	98-102	20
2XL	L4070405	182-188	106-110	20
3XL	L4070406	188-194	116-120	20

**2 PROTECTIVE SHORTS**

• ШОРТЫ ЗАЩИТНЫЕ КОРОТКИЕ • SCHUTZHOSEN KURZ

245 g/m<sup>2</sup>

100% COTTON

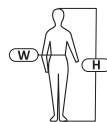

Kat. I  
Cat. I



- MATERIAL: 100% cotton.
- 10 pockets, including 4 with Velcro fastening. Mobile phone pocket. Double seams. Waist width adjustment with a rubber band. Key ring. Hammer loop. Tape measure loop. Narrow side pocket. ID insert.
- NORM: EN ISO 13688

Size	Code	H (cm)	W (cm)	☐
S	L4070301	158-164	72-76	20
M	L4070302	164-170	82-86	20
L	L4070303	170-176	90-94	20
XL	L4070304	176-182	98-102	20
2XL	L4070305	182-188	106-110	20
3XL	L4070306	188-194	116-120	20





1 PROTECTIVE CLOTHES — SETS (JACKET & BIB PANTS)

• ЗАЩИТНАЯ ОДЕЖДА – КОМПЛЕКТЫ (КУРТКА, ПОЛУКОМБИНЕЗОН) • SCHUTZKLEIDUNG - SETS (JACKE, LATZHOSE) DUNKELBLAU



210 g/m<sup>2</sup>



Special buckle construction to avoid self loosening

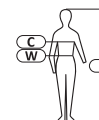

Kat. I  
Cat. I CE

- MATERIAL: 35% cotton, 65% polyester.
- **Jacket:** 2 pockets with Velcro fastening. Double seams. Ventilation openings to improve air circulation. Width adjustment at the jacket bottom with a rubber band. Buttoned-up cuffs. ID insert. **Bib pants:** 6 pockets, including 1 with a zip fastener. Double seams. Waist width adjustment with buttons and a rubber band. Adjustable braces with a fastener and a rubber band. Loop for hammer and tape measure. Contrasting seams, emphasizing the precision of finish. ID insert.
- NORM: EN ISO 13688

Size	Code	Colour	Code	Colour	Code	Colour	Code	Colour	H (cm)	C (cm)	W (cm)	Box
S	LPQK64S	Blue	LPQA64S	Green	LPQC64S	White	LPQE64S	Red	164	84-88	72-76	5
M	LPQK70M	Blue	LPQA70M	Green	LPQC70M	White	LPQE70M	Red	170	92-96	82-86	5
M	LPQK76M	Blue	LPQA76M	Green	LPQC76M	White	LPQE76M	Red	176	92-96	82-86	5
L	LPQK76L	Blue	LPQA76L	Green	LPQC76L	White	LPQE76L	Red	176	100-104	90-94	5
L	LPQK82L	Blue	LPQA82L	Green	LPQC82L	White	LPQE82L	Red	182	100-104	90-94	5
L	LPQK88L	Blue	LPQA88L	Green	LPQC88L	White	LPQE88L	Red	188	100-104	90-94	5
XL	LPQK76XL	Blue	LPQA76XL	Green	LPQC76XL	White	LPQE76XL	Red	176	108-112	98-102	5
XL	LPQK82XL	Blue	LPQA82XL	Green	LPQC82XL	White	LPQE82XL	Red	182	108-112	98-102	5
XL	LPQK88XL	Blue	LPQA88XL	Green	LPQC88XL	White	LPQE88XL	Red	188	108-112	98-102	5
2XL	LPQK822XL	Blue	LPQA822XL	Green	LPQC822XL	White	LPQE822XL	Red	182	116-120	106-110	5
2XL	LPQK882XL	Blue	LPQA882XL	Green	LPQC882XL	White	LPQE882XL	Red	188	116-120	106-110	5
3XL	LPQK943XL	Blue	LPQA943XL	Green	LPQC943XL	White	LPQE943XL	Red	194	126-130	116-120	5

### 1 PROTECTIVE BIB PANTS

• ПОЛУКОМБИНЕЗОНЫ ЗАЩИТНЫЕ • SCHUTZLATZHOSEN

## Quest

210  
g/m<sup>2</sup>



Special buckle construction to avoid self loosening

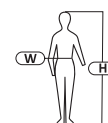

Kat. I  
Cat. I

- MATERIAL: 35% cotton, 65% polyester.
- 6 pockets, including 1 with Zip. Double seams. Waist width adjustment with buttons and a rubber band. Braces adjustable with a fastener and a rubber band. Loop for hammer and tape measure. Contrasting seams, emphasizing the precision of finish. ID insert.
- NORM: EN ISO 13688

Size	Code	Colour	Code	Colour	Code	Colour	H (cm)	W (cm)	
S	LPQL64S		LPQB64S		LPQD64S		164	72-76	10
M	LPQL70M		LPQB70M		LPQD70M		170	82-86	10
M	LPQL76M		LPQB76M		LPQD76M		176	82-86	10
L	LPQL76L		LPQB76L		LPQD76L		176	90-94	10
L	LPQL82L		LPQB82L		LPQD82L		182	90-94	10
L	LPQL88L		LPQB88L		LPQD88L		188	90-94	10
XL	LPQL76XL		LPQB76XL		LPQD76XL		176	98-102	10
XL	LPQL82XL		LPQB82XL		LPQD82XL		182	98-102	10
XL	LPQL88XL		LPQB88XL		LPQD88XL		188	98-102	10
2XL	LPQL822XL		LPQB822XL		LPQD822XL		182	106-110	10
2XL	LPQL882XL		LPQB882XL		LPQD882XL		188	106-110	10
3XL	LPQL943XL		LPQB943XL		LPQD943XL		194	116-120	10

### 1 REINFORCED WELDING CLOTHES – SETS (JACKET, BIB PANTS)

- ОДЕЖДА ДЛЯ СВАРЩИКА УСИЛЕННАЯ – КОМПЛЕКТЫ (КУРТКА, ПОЛУКОМБИНЕЗОН)
- SCHWEISSERKLEIDUNG VERSTÄRKT - SETS (JACKE, LATZHOSE)

380 g/m<sup>2</sup>

100% COTTON



Special buckle construction to avoid self loosening

CERTYFIKAT CIOP – PIB

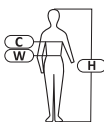

Kat. II CE

- MATERIAL: 100% cotton.
- Flame-retardant protective clothes designed for welding and related processes, resistant to hot agents and flame. Protect from ignition as a result of a short-term contact with flames (performance level A1+A2), convection heat (performance level B1) and thermal radiation (performance level C1). Made from thick cotton textile with a special satin weave and fire-retardant finish. The front of the jacket and the bib pants and the lower part of the sleeves are reinforced with the double textile layer to improve protection. Flame-retardant threads. Protection grade 1 (small splinters of melted metal). The clothes meet the requirements of the following standards: EN ISO 11611:2015, EN ISO 11612:2015, EN ISO 13688:2013.
- Jacket:** Zip covered with a snap-fastened fold. 2 zipped inner pockets. Width adjustment at the jacket bottom with a rubber band. Cuffs with concealed snap fasteners to enable adjustment. High-quality zip from a renowned supplier and YKK snap fasteners.
- Bib pants:** 4 pockets, including 1 inner zipped pocket. Additional crotch seam enforcement. Waist width adjustment with a rubber band. Adjustable braces with a fastener and rubber band.
- NORM: EN ISO 11611:2015, EN ISO 11612:2015, EN ISO 13688:2013

Size	Code	H [cm]	C [cm]	W [cm]	☐
S (A)	L4140511	164-170	96-104	84-92	20
M (A)	L4140512	170-176	96-104	84-92	20
M (B)	L4140522	170-176	104-112	92-100	20
L (A)	L4140513	176-182	96-104	84-92	20
L (B)	L4140523	176-182	104-112	92-100	20
L (C)	L4140533	176-182	112-120	100-108	20
XL (A)	L4140514	182-188	96-104	84-92	20
XL (B)	L4140524	182-188	104-112	92-100	20
XL (C)	L4140534	182-188	112-120	100-108	20
2XL (B)	L4140525	188-194	104-112	92-100	20
2XL (C)	L4140535	188-194	112-120	100-108	20
3XL (C)	L4140536	194-200	112-120	100-108	20

### 2 REINFORCED CUFF WELDING CLOTHES - SETS (JACKET, BIB PANTS)

- ОДЕЖДА ДЛЯ СВАРЩИКА С УСИЛЕННЫМИ МАНЖЕТАМИ - КОМПЛЕКТЫ (КУРТКА, ПОЛУКОМБИНЕЗОН)
- SCHWEISSERKLEIDUNG MIT VERSTÄRKTEN MANSCHETTEN - SETS (JACKE, LATZHOSE)

380 g/m<sup>2</sup>

100% COTTON



Special buckle construction to avoid self loosening

CERTYFIKAT CIOP – PIB

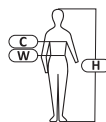

Kat. II CE

- MATERIAL: 100% cotton.
- Flame-retardant protective clothes designed for welding and related processes, resistant to hot agents and flame. Protect from ignition as a result of a short-term contact with flames (performance level A1+A2), convection heat (performance level B1) and thermal radiation (performance level C1). Made from thick cotton textile with a special satin weave and fire-retardant finish. The jacket cuffs are reinforced with the double textile layer to improve protection. Flame-retardant threads. Protection grade 1 (small splinters of melted metal). The clothes meet the requirements of the following standards: EN ISO 11611:2015, EN ISO 11612:2015, EN ISO 13688:2013.
- Jacket:** Zip covered with a snap-fastened fold. 2 zipped inner pockets. Width adjustment at the jacket bottom with a rubber band. Cuffs with concealed snap fasteners to enable adjustment. High-quality zip from a renowned supplier and YKK snap fasteners.
- Bib pants:** 4 pockets, including 1 inner zipped pocket. Additional crotch seam enforcement. Waist width adjustment with a rubber band. Adjustable braces with a fastener and rubber band.
- NORM: EN ISO 11611:2015, EN ISO 11612:2015, EN ISO 13688:2013

Size	Code	H [cm]	C [cm]	W [cm]	☐
S (A)	L4140611	164-170	96-104	84-92	20
M (A)	L4140612	170-176	96-104	84-92	20
M (B)	L4140622	170-176	104-112	92-100	20
L (A)	L4140613	176-182	96-104	84-92	20
L (B)	L4140623	176-182	104-112	92-100	20
L (C)	L4140633	176-182	112-120	100-108	20
XL (A)	L4140614	182-188	96-104	84-92	20
XL (B)	L4140624	182-188	104-112	92-100	20
XL (C)	L4140634	182-188	112-120	100-108	20
2XL (B)	L4140625	188-194	104-112	92-100	20
2XL (C)	L4140635	188-194	112-120	100-108	20
3XL (C)	L4140636	194-200	112-120	100-108	20

PROLINE  
LAHTI PRO  
MEGA  
JUCO  
OTHER BRANDS  
ENDI  
KLINGSPOR  
EXPRESS  
ACTION CAV  
TRITON  
VALCAN

**1 WELDING CLOTHES – SETS (JACKET, BIB PANTS)**

• СВАРОЧНАЯ ОДЕЖДА - КОМПЛЕКТЫ (КУРТКА И ПОЛУКОМБИНЕЗОН)  
• SCHWEISSERKLEIDUNG - SETS (JACKE, LATZHOSE)

**320**  
g/m<sup>2</sup>

**100%**  
COTTON



Special buckle construction to avoid self loosening

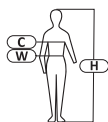

Kat. II  
Cat. II CE

- MATERIAL: 100% cotton.
- Flame-retardant protective clothes designed for welding and related processes, resistant to hot agents and flame. Protect from ignition as a result of a short-term contact with flames (performance level A1+A2), molten iron spatter (performance level E2), convection heat (performance level B1), contact heat (performance level F1) and thermal radiation (performance level C1). Made from thick cotton textile with a fire-retardant finish. Flame-retardant threads. Protection grade 1 (small splinters of melted metal). The clothes meet the requirements of the following standards: EN ISO 11611:2015, EN ISO 11612:2015, EN ISO 13688:2013.
- **Jacket:** buttoned-up, buttons covered with a fold. Zipped inner pocket. Width adjustment at the jacket bottom with a rubber band. Cuffs with concealed snap fasteners.
- **Bib pants:** 4 pockets, including 1 inner zipped pocket. Additional crotch seam enforcement. Waist width adjustment with a rubber band. Adjustable braces with a fastener and rubber band.
- NORM: EN ISO 11611:2015, EN ISO 11612:2015, EN ISO 13688:2013

Size	Code	H (cm)	C (cm)	W (cm)	☐
S (A)	L4140311	164-170	96-104	84-92	20
M (A)	L4140312	170-176	96-104	84-92	20
M (B)	L4140322	170-176	104-112	92-100	20
L (A)	L4140313	176-182	96-104	84-92	20
L (B)	L4140323	176-182	104-112	92-100	20
L (C)	L4140333	176-182	112-120	100-108	20
XL (A)	L4140314	182-188	96-104	84-92	20
XL (B)	L4140324	182-188	104-112	92-100	20
XL (C)	L4140334	182-188	112-120	100-108	20
2XL (B)	L4140325	188-194	104-112	92-100	20
2XL (C)	L4140335	188-194	112-120	100-108	20
3XL (C)	L4140336	194-200	112-120	100-108	20

**2 ANTISTATIC WELDING CLOTHES – SETS (JACKET, BIB PANTS)**

• АНТИСТАТИЧЕСКАЯ СВАРОЧНАЯ ОДЕЖДА - КОМПЛЕКТЫ (КУРТКА И ПОЛУКОМБИНЕЗОН)  
• SCHWEISSERKLEIDUNG ANTISTATISCHE - SETS (JACKE, LATZHOSE)

**310**  
g/m<sup>2</sup>

**99%**  
COTTON

**1%**  
ANTISTATIC  
THREAD



Special buckle construction to avoid self loosening

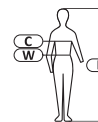

Kat. II  
Cat. II CE

- MATERIAL: 99% cotton, 1% antistatic thread.
- Flame-retardant protective clothes designed for welding and related processes, resistant to hot agents and flame, with antistatic properties. Protect from ignition as a result of a short-term contact with flames (performance level A1+A2), molten iron spatter (performance level E2), convection heat (performance level B1), contact heat (performance level F1), thermal radiation (performance level C1) and prevent static discharge able to start ignition. Made from thick cotton textile with a fire-retardant and antistatic finish. Flame-retardant threads. Protection grade 1 (small splinters of melted metal). The clothes meet the requirements of the following standards: EN ISO 11611:2015, EN ISO 11612:2015, EN 1149-5:2008, EN ISO 13688:2013.
- **Jacket:** buttoned-up, buttons covered with a fold. Zipped inner pocket. Width adjustment at the jacket bottom with a rubber band. Cuffs with concealed snap fasteners.
- **Bib pants:** 4 pockets, including 1 inner zipped pocket. Additional crotch seam enforcement. Waist width adjustment with a rubber band. Adjustable braces with a fastener and rubber band.
- NORM: EN ISO 11611:2015, EN ISO 11612:2015, EN 1149-5:2008, EN ISO 13688:2013

Size	Code	H (cm)	C (cm)	W (cm)	☐
S (A)	L4140411	164-170	96-104	84-92	20
M (A)	L4140412	170-176	96-104	84-92	20
M (B)	L4140422	170-176	104-112	92-100	20
L (A)	L4140413	176-182	96-104	84-92	20
L (B)	L4140423	176-182	104-112	92-100	20
L (C)	L4140433	176-182	112-120	100-108	20
XL (A)	L4140414	182-188	96-104	84-92	20
XL (B)	L4140424	182-188	104-112	92-100	20
XL (C)	L4140434	182-188	112-120	100-108	20
2XL (B)	L4140425	188-194	104-112	92-100	20
2XL (C)	L4140435	188-194	112-120	100-108	20
3XL (C)	L4140436	194-200	112-120	100-108	20

**1 ANTISTATIC CLOTHES – SETS (JACKET, BIB PANTS)**

- АНТИСТАТИЧЕСКАЯ ОДЕЖДА – КОМПЛЕКТЫ (КУРТКА И ПОЛУКОМБИНЕЗОН)
- ANTISTATISCHE KLEIDUNG - SETS (JACKE, LATZHOSE)

**243**  
g/m<sup>2</sup>

**1%**  
ANTISTATIC  
THREAD



CERTYFIKAT  
**CIOP – PIB**

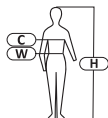

**Kat. II**  
**Cat. II** **CE**

- **MATERIAL:** 35% cotton, 64% polyester, 1% antistatic thread.
- Antistatic protective clothes able to dissipate and discharge static charges. Prevent electrostatic discharge able to start ignition. Made from a textile with antistatic finish. The clothes meet the requirements of the following standards: EN 1149-5:2008 and EN ISO 13688:2013.
- **Jacket:** Buttoned-up, buttons covered with a fold. Two buttoned-up pockets. Width adjustment at the jacket bottom with a rubber. Buttoned-up cuffs.
- **Bib pants:** 4 pockets, including 1 buttoned-up pocket. Additional crotch seam enforcement. Waist width adjustment with a rubber band. Adjustable braces with a fastener and rubber band.
- **NORM:** EN 1149-5:2008 i EN ISO 13688:2013

Size	Code	H (cm)	C (cm)	W (cm)	☐
S (A)	<b>L4140711</b>	164-170	96-104	84-92	20
M (A)	<b>L4140712</b>	170-176	96-104	84-92	20
M (B)	<b>L4140722</b>	170-176	104-112	92-100	20
L (A)	<b>L4140713</b>	176-182	96-104	84-92	20
L (B)	<b>L4140723</b>	176-182	104-112	92-100	20
L (C)	<b>L4140733</b>	176-182	112-120	100-108	20
XL (A)	<b>L4140714</b>	182-188	96-104	84-92	20
XL (B)	<b>L4140724</b>	182-188	104-112	92-100	20
XL (C)	<b>L4140734</b>	182-188	112-120	100-108	20
2XL (B)	<b>L4140725</b>	188-194	104-112	92-100	20
2XL (C)	<b>L4140735</b>	188-194	112-120	100-108	20
3XL (C)	<b>L4140736</b>	194-200	112-120	100-108	20

**2 PROTECTIVE COVERALLS**

- ФАРТУКИ ЗАЩИТНЫЕ • SCHUTZSCHÜRZEN

**260**  
g/m<sup>2</sup>

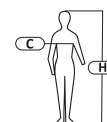

**Kat. I**  
**Cat. I** **CE**

- **MATERIAL:** 35% cotton, 65% polyester.
- 5 pockets, including 2 with a snap fastener. Key ring. Double seams. Pocket bottom strengthened with double textile layer, protecting from chafing. Adjustable, buttoned-up cuffs. ID insert.
- **NORM:** EN ISO 13688

Size	Code	H (cm)	C (cm)	☐
S	<b>L4160101</b>	158-164	84-88	20
M	<b>L4160102</b>	164-170	92-96	20
L	<b>L4160103</b>	170-176	100-104	20
XL	<b>L4160104</b>	176-182	108-112	20
2XL	<b>L4160105</b>	182-188	116-120	20
3XL	<b>L4160106</b>	188-194	126-130	20

## 1 POLO SHIRTS

• ТЕХНИСКИ • ПОЛОHEMDEN

220 g/m<sup>2</sup>

100% COTTON

RING-SPUN



Decorative reinforcements

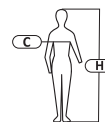

- MATERIAL: 100% cotton.
- T-shirts with a collar and two buttons. Ring-spun cotton, characterised by high density, combined with softness and smoothness, guarantees strength and resistance to chafing, and ensures comfortable wearing. 220 g/m<sup>2</sup>. Decorative reinforcements from checked textile on the sleeves, button placket and inside the collar increase product quality and extend its usable life.
- NORM: EN ISO 13688

Size	Code	Colour	Code	Colour	Code	Colour	Code	Colour	Code	Colour	Code	Colour	Code	Colour	H (cm)	C (cm)	Box
S	L4030901	Green	L4030701	Red	L4030601	Grey	L4030501	Blue	L4030301	Black	L4030801	White	L4030401	Light Blue	158-164	84-88	40
M	L4030902	Green	L4030702	Red	L4030602	Grey	L4030502	Blue	L4030302	Black	L4030802	White	L4030402	Light Blue	164-170	92-96	40
L	L4030903	Green	L4030703	Red	L4030603	Grey	L4030503	Blue	L4030303	Black	L4030803	White	L4030403	Light Blue	170-176	100-104	40
XL	L4030904	Green	L4030704	Red	L4030604	Grey	L4030504	Blue	L4030304	Black	L4030804	White	L4030404	Light Blue	176-182	108-112	40
2XL	L4030905	Green	L4030705	Red	L4030605	Grey	L4030505	Blue	L4030305	Black	L4030805	White	L4030405	Light Blue	182-188	116-120	40
3XL	L4030906	Green	L4030706	Red	L4030606	Grey	L4030506	Blue	L4030306	Black	L4030806	White	L4030406	Light Blue	188-194	126-130	40

## 2 POLO SHIRTS

• ТЕХНИСКИ • ПОЛОHEMDEN

190 g/m<sup>2</sup>

100% COTTON

RING-SPUN



- MATERIAL: 100% cotton
- Shirts with collar fastened with 3 buttons. Ring-spun cotton of a high density, but simultaneously soft and smooth, which guarantees durability, abrasion-resistance and comfort.
- NORM: EN ISO 13688

Size	Code	Colour	Code	Colour	Code	Colour	Code	Colour	H (cm)	C (cm)	Box
S	L4031301	Red	L4031201	Blue	L4031101	Grey	L4031001	Black	158-164	84-88	50
M	L4031302	Red	L4031202	Blue	L4031102	Grey	L4031002	Black	164-170	92-96	50
L	L4031303	Red	L4031203	Blue	L4031103	Grey	L4031003	Black	170-176	100-104	50
XL	L4031304	Red	L4031204	Blue	L4031104	Grey	L4031004	Black	176-182	108-112	50
2XL	L4031305	Red	L4031205	Blue	L4031105	Grey	L4031005	Black	182-188	116-120	50
3XL	L4031306	Red	L4031206	Blue	L4031106	Grey	L4031006	Black	188-194	126-130	50

**1 T-SHIRTS**  
• ФУТБОЛКИ • T-SHIRTS

**180**  
g/m<sup>2</sup>

**100%**  
COTTON

**RING-SPUN**

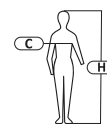

- MATERIAL: 100% cotton
- Ring-spun cotton, characterised by high density, combined with softness and smoothness, guarantees strength and resistance to chafing, and ensures comfortable wearing. Bands on scruff and arms ensure additional reinforcement. Double seams increase usable life. Sufficiently high weight (180 g/m<sup>2</sup>) is perfect for prints.
- NORM: EN ISO 13688

Size	Code	Colour	Code	Colour	Code	Colour	Code	Colour	Code	Colour	Code	Colour	Code	Colour	Code	Colour	Code	Colour	H (cm)	C (cm)	Box
S	L4020601	Green	L4020101	Red	L4020201	Grey	L4020301	Blue	L4020501	Black	L4020401	White	L4021901	Light Blue	L4021801	Dark Grey	L4021701	Orange	158-164	84-88	80
M	L4020602	Green	L4020102	Red	L4020202	Grey	L4020302	Blue	L4020502	Black	L4020402	White	L4021902	Light Blue	L4021802	Dark Grey	L4021702	Orange	164-170	94-100	80
L	L4020603	Green	L4020103	Red	L4020203	Grey	L4020303	Blue	L4020503	Black	L4020403	White	L4021903	Light Blue	L4021803	Dark Grey	L4021703	Orange	170-176	100-106	80
XL	L4020604	Green	L4020104	Red	L4020204	Grey	L4020304	Blue	L4020504	Black	L4020404	White	L4021904	Light Blue	L4021804	Dark Grey	L4021704	Orange	176-182	106-112	80
2XL	L4020605	Green	L4020105	Red	L4020205	Grey	L4020305	Blue	L4020505	Black	L4020405	White	L4021905	Light Blue	L4021805	Dark Grey	L4021705	Orange	182-188	112-116	80
3XL	L4020606	Green	L4020106	Red	L4020206	Grey	L4020306	Blue	L4020506	Black	L4020406	White	L4021906	Light Blue	L4021806	Dark Grey	L4021706	Orange	188-194	116-122	80

## 1 LADIES' T-SHIRTS

• ФУТБОЛКИ ЖЕНСКИЕ • DAMEN T-SHIRTS

180  
g/m<sup>2</sup>

100%  
COTTON

RING-SPUN

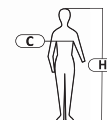

- MATERIAL: 100% cotton.
- Ring-spun cotton, characterised with high density, combined with softness and smoothness, guarantees strength and resistance to chafing, and ensures comfortable wearing. Double seams increase usable life. Sufficiently high weight (180 g/m<sup>2</sup>) is perfect for prints.
- NORM: EN ISO 13688

Size	Code	Colour	Code	Colour	Code	Colour	Code	Colour	H (cm)	C (cm)	☐
S	L4021101	Red	L4021201	Grey	L4021301	Blue	L4021401	Black	158-164	84-88	50
M	L4021102	Red	L4021202	Grey	L4021302	Blue	L4021402	Black	164-170	92-96	50
L	L4021103	Red	L4021203	Grey	L4021303	Blue	L4021403	Black	170-176	100-104	50
XL	L4021104	Red	L4021204	Grey	L4021304	Blue	L4021404	Black	170-176	110-116	50
2XL	L4021105	Red	L4021205	Grey	L4021305	Blue	L4021405	Black	176-182	122-128	50
3XL	L4021106	Red	L4021206	Grey	L4021306	Blue	L4021406	Black	176-182	134-140	50

## 2 FUNCTIONAL T-SHIRTS

• ФУТБОЛКИ ФУНКЦИОНАЛЬНЫЕ • FUNKTIONALET-SHIRTS

120  
g/m<sup>2</sup>

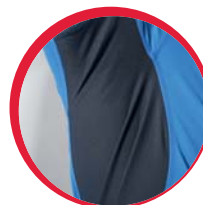

Mesh inserts under the arms ensure excellent ventilation



Reflective elements increasing visibility

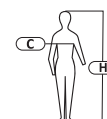

- MATERIAL: 100% polyester.
- Moisture is removed outside to ensure comfort and cool feeling during workout. The T-shirt is made from pleasant, flexible knitwear 120 g/m<sup>2</sup> which fits the body perfectly. Mesh inserts under the arms. Extra reflective components thanks to which the user is more visible also at night.
- NORM: EN ISO 13688

Size	Code	Colour	Code	Colour	Code	Colour	H (cm)	C (cm)	☐
S	L4021001	Blue	L4021501	Grey	L4021601	Red	158-164	84-88	50
M	L4021002	Blue	L4021502	Grey	L4021602	Red	164-170	92-96	50
L	L4021003	Blue	L4021503	Grey	L4021603	Red	170-176	100-104	50
XL	L4021004	Blue	L4021504	Grey	L4021604	Red	176-182	108-112	50
2XL	L4021005	Blue	L4021505	Grey	L4021605	Red	182-188	116-120	50
3XL	L4021006	Blue	L4021506	Grey	L4021606	Red	188-194	126-130	50







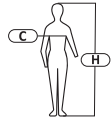













**1 SLEEVELESS T-SHIRT**

• МАЙКИ БЕЗ РУКАВОВ • ÄRMELLOSE SHIRTS

**160**  
g/m<sup>2</sup>**100%**  
COTTON  
RING-SPUNKat. I  
Cat. I

- MATERIAL: 100% cotton
- Ring-spun cotton of a high density, but simultaneously soft and smooth, which guarantees durability, abrasion-resistance and comfort.
- NORM: EN ISO 13688







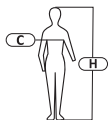





Size	Code	Colour	Code	Colour	Code	Colour	H (cm)	C (cm)	
S	L4022201		L4022001		L4022101		158-164	84-88	100
M	L4022202		L4022002		L4022102		164-170	92-96	100
L	L4022203		L4022003		L4022103		170-176	100-104	100
XL	L4022204		L4022004		L4022104		176-182	108-112	100
2XL	L4022205		L4022005		L4022105		182-188	116-120	100
3XL	L4022206		L4022006		L4022106		188-194	126-130	100

**2 LONG-SLEEVE T-SHIRTS**

• МАЙКИ С ДЛИННЫМ РУКАВОМ • LANGARM-SHIRTS

**190**  
g/m<sup>2</sup>**100%**  
COTTON  
RING-SPUNKat. I  
Cat. I

- MATERIAL: 100% cotton
- Ring-spun cotton of a high density, but simultaneously soft and smooth, which guarantees durability, abrasion-resistance and comfort. Elastic welt cuffs.
- NORM: EN ISO 13688

Size	Code	Colour	Code	Colour	H (cm)	C (cm)	
S	L4022301		L4022401		158-164	84-88	50
M	L4022302		L4022402		164-170	92-96	50
L	L4022303		L4022403		170-176	100-104	50
XL	L4022304		L4022404		176-182	108-112	50
2XL	L4022305		L4022405		182-188	116-120	50
3XL	L4022306		L4022406		188-194	126-130	50

**1 CHECKED FLANNEL SHIRTS**

• РУБАШКИ ФЛАНЕЛЕВЫЕ В КЛЕТКУ • FLANNELHEMDEN MIT KAROMUSTER

170 g/m<sup>2</sup>

100% COTTON

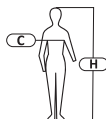

- MATERIAL: 100% cotton 170 g/m<sup>2</sup>.
- Buttoned-up. High-quality soft and smooth woven cotton ensures comfortable use. Single pocket.
- NORM: EN ISO 13688

Size	Code	H (cm)	C (cm)	☐
S	L4180301	158-164	84-88	20
M	L4180302	164-170	92-96	20
L	L4180303	170-176	100-104	20
XL	L4180304	176-182	108-112	20
2XL	L4180305	182-188	116-120	20
3XL	L4180306	188-194	126-130	20

**2 CHECKED FLANNEL SHIRTS**

• РУБАШКИ ФЛАНЕЛЕВЫЕ В КЛЕТКУ • FLANNELHEMDEN MIT KAROMUSTER

170 g/m<sup>2</sup>

100% COTTON

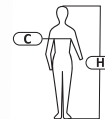

- MATERIAL: 100% cotton 170 g/m<sup>2</sup>.
- Buttoned-up. High-quality soft and smooth woven cotton ensures comfortable use. Single pocket.
- NORM: EN ISO 13688

Size	Code	H (cm)	C (cm)	☐
S	L4180401	158-164	84-88	20
M	L4180402	164-170	92-96	20
L	L4180403	170-176	100-104	20
XL	L4180404	176-182	108-112	20
2XL	L4180405	182-188	116-120	20
3XL	L4180406	188-194	126-130	20

**3 CHECKED FLANNEL SHIRTS**

• РУБАШКИ ФЛАНЕЛЕВЫЕ В КЛЕТКУ • FLANNELHEMDEN MIT KAROMUSTER

120 g/m<sup>2</sup>

100% COTTON

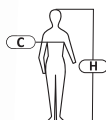

- MATERIAL: 100% cotton 120 g/m<sup>2</sup>.
- Buttoned-up. Single pocket.
- NORM: EN ISO 13688

Size	Code	H (cm)	C (cm)	☐
S	LPKF2S	164-170	84-88	48
M	LPKF2M	170-176	92-96	48
L	LPKF2L	176-182	100-104	48
XL	LPKF2XL	182-188	108-112	48
2XL	LPKF22XL	188-194	116-120	48

**4 CHECKED FLANNEL SHIRTS**

• РУБАШКИ ФЛАНЕЛЕВЫЕ В КЛЕТКУ • FLANNELHEMDEN MIT KAROMUSTER

120 g/m<sup>2</sup>

100% COTTON

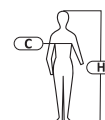

- MATERIAL: 100% cotton 120 g/m<sup>2</sup>.
- Buttoned-up. Single pocket.
- NORM: EN ISO 13688

Size	Code	H (cm)	C (cm)	☐
S	LPKF1S	164-170	84-88	48
M	LPKF1M	170-176	92-96	48
L	LPKF1L	176-182	100-104	48
XL	LPKF1XL	182-188	108-112	48
2XL	LPKF12XL	188-194	116-120	48

**1 CHECKED FLANNEL SHIRTS**

• РУБАШКИ ФЛАНЕЛЕВЫЕ В КЛЕТКУ N • FLANELLEMEDEN MIT KAROMUSTER - BLAU

**120**  
g/m<sup>2</sup>

**100%**  
COTTON

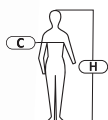

**Kat. I**  
**Cat. I** **CE**

- MATERIAL: 100% cotton 120 g/m<sup>2</sup>.
- Buttoned-up. Single pocket.
- NORM: EN ISO 13688

Size	Code	H (cm)	C (cm)	
S	LPKF3S	164-170	84-88	48
M	LPKF3M	170-176	92-96	48
L	LPKF3L	176-182	100-104	48
XL	LPKF3XL	182-188	108-112	48
2XL	LPKF32XL	188-194	116-120	48

**2 PADDED FLANNEL SHIRTS**

• РУБАШКИ ФЛАНЕЛЕВЫЕ УТЕПЛЕННЫЕ • FLANELLEMEDEN WATTIERT

**120**  
g/m<sup>2</sup>  
COATING

**120**  
g/m<sup>2</sup>  
PADDING

**100%**  
COTTON



Quilted lining

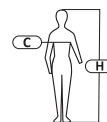

**Kat. I**  
**Cat. I** **CE**

- MATERIAL: Coating: 100% cotton 120 g/m<sup>2</sup>. Padding: 120 g/m<sup>2</sup>. Lining: taffeta 50 g/m<sup>2</sup>.
- Buttoned-up. 4 pockets, including 2 with button fastening. Buttoned-up cuffs.
- NORM: EN ISO 13688

Size	Code	H (cm)	C (cm)	
S	L4180201	158-164	84-88	20
M	L4180202	164-170	92-96	20
L	L4180203	170-176	100-104	20
XL	L4180204	176-182	108-112	20
2XL	L4180205	182-188	116-120	20
3XL	L4180206	188-194	126-130	20



**1 HOODED SWEATSHIRTS WITH ZIP**

• КУРТКИ С КАПЮШОНОМ И ЗАСТЁЖКОЙ-МОЛНИЕЙ • SWEATSHIRTS MIT KARUZEN UND REISSVERSCHLUSS

**320**  
g/m<sup>2</sup>

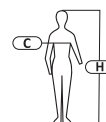

- MATERIAL: 60% cotton, 35% polyester, 5% viscose, 320 g/m<sup>2</sup>, anti-pilling and padded inside.
- Ring-spun cotton, characterised by high density, combined with softness and smoothness, guarantees strength and chafing resistance, and ensures comfortable use experience. Practical hood with cotton lining and adjustment by means of straps, as well as high collar, offer perfect protection from cold and wind. 2 pockets. Hoodie cuffs and bottom with an elastic band.
- NORM: EN ISO 13688

Size	Code	Colour	Code	Colour	H [cm]	C [cm]	☐
S	L4011201	■	L4010801	■	158-164	84-88	20
M	L4011202	■	L4010802	■	164-170	92-96	20
L	L4011203	■	L4010803	■	170-176	100-104	20
XL	L4011204	■	L4010804	■	176-182	108-112	20
2XL	L4011205	■	L4010805	■	182-188	116-120	20
3XL	L4011206	■	L4010806	■	188-194	126-130	20

**2 HOODED SWEATSHIRTS**

• КУРТКИ С КАПЮШОНОМ • SWEATSHIRTS MIT KARUZEN

**320**  
g/m<sup>2</sup>

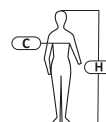

- MATERIAL: 60% cotton, 35% polyester, 5% viscose, 320 g/m<sup>2</sup>, anti-pilling and padded inside.
- Ring-spun cotton, characterised by high density, combined with softness and smoothness, guarantees strength and chafing resistance, and ensures comfortable use experience. A practical hood with a cotton lining and strap adjustments offers perfect protection from cold and wind. A large kangaroo front pocket. Cuffs and hoodie bottom ended with an elastic strip.
- NORM: EN ISO 13688

Size	Code	Colour	Code	Colour	H [cm]	C [cm]	☐
S	L4010701	■	L4010401	■	158-164	84-88	20
M	L4010702	■	L4010402	■	164-170	92-96	20
L	L4010703	■	L4010403	■	170-176	100-104	20
XL	L4010704	■	L4010404	■	176-182	108-112	20
2XL	L4010705	■	L4010405	■	182-188	116-120	20
3XL	L4010706	■	L4010406	■	188-194	126-130	20

1 SWEATSHIRTS

• КУРТКИ • SWEATSHIRTS

320 g/m<sup>2</sup>

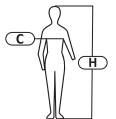

Kat. I  
Cat. I



- MATERIAL: 60% cotton, 35% polyester, 5% viscose, 320 g/m<sup>2</sup>, anti-pilling and padded inside.
- Ring-spun cotton, characterised by high density, combined with softness and smoothness, guarantees strength and chafing resistance, and ensures comfortable use experience. Cuffs and bottom with an elastic band.
- NORM: EN ISO 13688

Size	Code	Colour	Code	Colour	H (cm)	C (cm)	☐
S	L4011701		L4011301		158-164	84-88	20
M	L4011702		L4011302		164-170	92-96	20
L	L4011703		L4011303		170-176	100-104	20
XL	L4011704		L4011304		176-182	108-112	20
2XL	L4011705		L4011305		182-188	116-120	20
3XL	L4011706		L4011306		188-194	126-130	20

2 FLEECE JACKETS WITH REINFORCEMENTS

• КУРТКИ ФЛИСОВЫЕ С УПРОЧНЕНИЕМ • FLEECEJACKE MIT VERSTÄRKUNGEN

290 g/m<sup>2</sup>

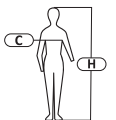

Kat. I  
Cat. I



- MATERIAL: Fleece 100% polyester 290 g/m<sup>2</sup>, short pile, brushed bilaterally and anti-pilling. Inserts: Oxford 600D 100% polyester 230 g/m<sup>2</sup>.
- 3 zipped pockets. Zip. Wind-proof zips. Zip cover. Width adjustment at the jacket bottom with a special drawstring. Sleeves, yoke and bottom strengthened with a abrasion resistant textile.
- NORM: EN ISO 13688

Size	Code	Colour	Code	Colour	H (cm)	C (cm)	☐
S	L4011401		L4011501		158-164	84-88	20
M	L4011402		L4011502		164-170	92-96	20
L	L4011403		L4011503		170-176	100-104	20
XL	L4011404		L4011504		176-182	108-112	20
2XL	L4011405		L4011505		182-188	116-120	20
3XL	L4011406		L4011506		188-194	126-130	20

### 1 FLEECE JACKETS WITH REINFORCEMENTS

• КУРТКИ ФЛИСОВЫЕ С УПРОЧНЕНИЕМ • FLEECEJACKEN MIT VERSTÄRKUNGEN

290 g/m<sup>2</sup>

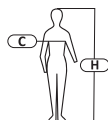

- MATERIAL: Fleece 100% polyester 290 g/m<sup>2</sup>, short pile, brushed bilaterally and anti-pilling. Inserts: Oxford 600D 100% polyester 230 g/m<sup>2</sup>.
- 3 zipped pockets. Zip. Wind-proof zips. Zip cover: Width adjustment at the jacket bottom with a special drawstring. Sleeves, yoke and bottom strengthened with a abrasion resistant textile.
- NORM: EN ISO 13688

Size	Code	H [cm]	C [cm]	☐
S	L4010501	158-164	84-88	20
M	L4010502	164-170	92-96	20
L	L4010503	170-176	100-104	20
XL	L4010504	176-182	108-112	20
2XL	L4010505	182-188	116-120	20
3XL	L4010506	188-194	126-130	20

### 2 FLEECE JACKETS

• КУРТКИ ФЛИСОВЫЕ • FLEECEJACKEN

290 g/m<sup>2</sup>

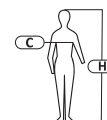

- MATERIAL: Fleece 100% polyester 290 g/m<sup>2</sup>, short pile, brushed bilaterally and anti-pilling.
- 3 zipped pockets. Zip. Wind-proof zips. Width adjustment at the jacket bottom with a special drawstring.
- NORM: EN ISO 13688

Size	Code	H [cm]	C [cm]	☐
S	LPBP1S	158-164	84-88	20
M	LPBP1M	164-170	92-96	20
L	LPBP1L	170-176	100-104	20
XL	LPBP1XL	176-182	108-112	20
2XL	LPBP12XL	182-188	116-120	20
3XL	LPBP13XL	188-194	126-130	20

### 3 FLEECE JACKETS

• КУРТКИ ФЛИСОВЫЕ • FLEECEJACKEN

290 g/m<sup>2</sup>

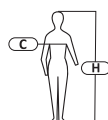

- MATERIAL: Fleece 100% polyester 290 g/m<sup>2</sup>, short pile, brushed bilaterally and anti-pilling.
- 3 zipped pockets. Zip. Wind-proof zips. Zip cover: Width adjustment at the jacket bottom with a special drawstring.
- NORM: EN ISO 13688

Size	Code	H [cm]	C [cm]	☐
S	L4011601	158-164	84-88	20
M	L4011602	164-170	92-96	20
L	L4011603	170-176	100-104	20
XL	L4011604	176-182	108-112	20
2XL	L4011605	182-188	116-120	20
3XL	L4011606	188-194	126-130	20



**1 FLEECE JACKETS**

• КУРТКИ ФЛИСОВЫЕ • FLEESEJACKEN

**290**  
g/m<sup>2</sup>

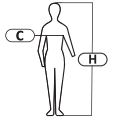

- MATERIAL: Fleece 100% polyester 290 g/m<sup>2</sup>, short pile, brushed bilaterally and anti-pilling.
- 3 zipped pockets. Zip. Wind-proof zips. Zip cover. Width adjustment at the jacket bottom with a special drawstring.
- NORM: EN ISO 13688

Size	Code	Colour	Code	Colour	Code	Colour	Code	Colour	H (cm)	C (cm)	☐
S	LPBP2S		L4010201		L4010101		L4011801		158-164	84-88	20
M	LPBP2M		L4010202		L4010102		L4011802		164-170	92-96	20
L	LPBP2L		L4010203		L4010103		L4011803		170-176	100-104	20
XL	LPBP2XL		L4010204		L4010104		L4011804		176-182	108-112	20
2XL	LPBP22XL		L4010205		L4010105		L4011805		182-188	116-120	20
3XL	LPBP23XL		L4010206		L4010106		L4011806		188-194	126-130	20

**2 FLEECE JACKETS WITH HALF ZIP**

• КУРТКИ ФЛИСОВЫЕ С КОРОТКОЙ МОЛНИЕЙ • FLEESEPULLIS MIT KURZEM REISSVERSCHLUSS

**180**  
g/m<sup>2</sup>

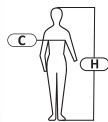

- MATERIAL: Fleece 100% polyester 180 g/m<sup>2</sup>, short pile, brushed bilaterally and anti-pilling.
- Practical zipped pocket on the sleeve. Half zip. Wind-proof zips. Zip cover. Sleeves ended with an elastic cuff ensuring perfect fit.
- NORM: EN ISO 13688

Size	Code	H (cm)	C (cm)	☐
S	LPBP3S	158-164	84-88	20
M	LPBP3M	164-170	92-96	20
L	LPBP3L	170-176	100-104	20
XL	LPBP3XL	176-182	108-112	20
2XL	LPBP32XL	182-188	116-120	20
3XL	LPBP33XL	188-194	126-130	20



PROLINE

LAHTI PRO

MEGA

JUCCO

OTHER BRANDS

ERDI

KLINGSPOR

EXPRESS

ACTION CAN

TRYTON

VULCAN

**1 LADIES' FLEECE JACKETS**

• КУРТКИ ФЛИСОВЫЕ ЖЕНСКИЕ • DAMENFLEECEJACKEN

**290**  
g/m<sup>2</sup>

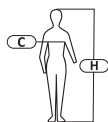

- MATERIAL: Fleece 100% polyester 290 g/m<sup>2</sup>, short pile, brushed bilaterally and anti-pilling.
- 2 zipped pockets. Zip. Wind-proof zips. Zip cover.
- NORM: EN ISO 13688

Size	Code	H [cm]	C [cm]	☐
S	L4010301	158-164	82-86	20
M	L4010302	164-170	88-92	20
L	L4010303	170-176	94-98	20
XL	L4010304	170-176	100-104	20
2XL	L4010305	176-182	106-110	20
3XL	L4010306	176-182	112-116	20

**2 LADIES' FLEECE JACKETS**

• КУРТКИ ФЛИСОВЫЕ ЖЕНСКИЕ • DAMENFLEECEJACKEN

**290**  
g/m<sup>2</sup>

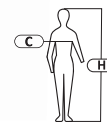

- MATERIAL: Fleece 100% polyester 290 g/m<sup>2</sup>, short pile, brushed bilaterally and anti-pilling.
- 2 zipped pockets. Zip. Wind-proof zips. Zip cover.
- NORM: EN ISO 13688

Size	Code	H [cm]	C [cm]	☐
S	L4010601	158-164	82-86	20
M	L4010602	164-170	88-92	20
L	L4010603	170-176	94-98	20
XL	L4010604	170-176	100-104	20
2XL	L4010605	176-182	106-110	20
3XL	L4010606	176-182	112-116	20





**1 JACKETS**  
• КУРТКИ • JACKEN

**400**  
g/m<sup>2</sup>

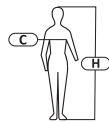

- MATERIAL: 100% polyester. Special 3-ply textile with TPU membrane, waterproof (5000 mm), breathable (3000g/m<sup>2</sup>/24 h), guaranteeing excellent wearing.
- 4 zippered pockets, including a practical one on the sleeve. Zip cover. Reflective components. Sleeves finished with cuffs with Velcro adjustment. Width adjustment at the jacket bottom, with a two-side drawstring with a stopper.
- NORM: EN ISO 13688

Size	Code	H (cm)	C (cm)	☐
S	L4092001	158-164	84-88	20
M	L4092002	164-170	92-96	20
L	L4092003	170-176	100-104	20
XL	L4092004	176-182	108-112	20
2XL	L4092005	182-188	116-120	20
3XL	L4092006	188-194	126-130	20

**2 SOFT-SHELL JACKETS WITH HOOD**  
• КУРТКИ СОФТШЕЛЛ С КАПУШОНОМ • SOFTSHELLJACKEN MIT KAPUZE

**300**  
g/m<sup>2</sup>

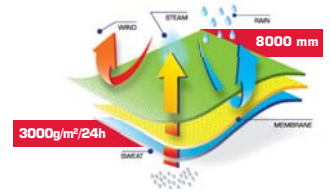
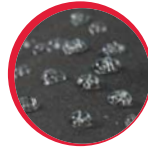

Material with reflective print increasing the visibility after dark.

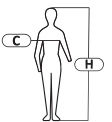

- MATERIAL: Shell: soft-shell fabric, 100% polyester with a weight of 300 g/m<sup>2</sup>. Lining: microfleece with a weight of 160 g/m<sup>2</sup>.
- Special 3-layer soft-shell fabric with a TPU membrane, waterproof (8000 mm), breathable (3000 g/m<sup>2</sup>/24h), ensuring high comfort of use. Fabric with a reflective print that increases visibility after dark. 5 pockets (3 outer with a zipper and 2 inner). Detachable, adjustable width hood. Zipper. Zipper cover. Sleeves with Velcro strap adjustment. Jacket bottom width adjustment with a special drawstring.
- NORM: EN ISO 13688

Size	Code	H (cm)	C (cm)	☐
S	L4092301	158-164	84-88	20
M	L4092302	164-170	92-96	20
L	L4092303	170-176	100-104	20
XL	L4092304	176-182	108-112	20
2XL	L4092305	182-188	116-120	20
3XL	L4092306	188-194	126-130	20

PROLINE

LAHTI PRO

MEGA

JUCCO

OTHER BRANDS

ERDI

KLINGSPOR

EXPRESS

ACTION CAN

TRAYTON

VULCAN

**1 SOFT-SHELL HOODED JACKETS**

• КУРТКИ СОФТШЕЛЛ С КАПЮШОНОМ • SOFTCOATINGJACKEN MIT KARUZE

**310**  
g/m<sup>2</sup>

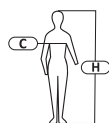
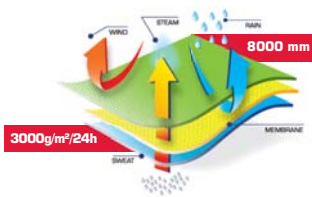

- MATERIAL: Coating: soft-shell textile, 100% polyester 310 g/m<sup>2</sup>. Lining: microfleece 160 g/m<sup>2</sup>.
- Special 3-layer soft-shell textile with TPU membrane, waterproof (8000 mm), breathable (3000g/m<sup>2</sup>/24h), ensuring high comfort of use. 5 pockets (3 outer with zip fasteners and 2 inner ones). Detachable hood with width adjustment. Zip fastener. Zip cover. Sleeves with Velcro adjustment. Width adjustment at the jacket bottom with a special drawstring.
- NORM: EN ISO 13688

Size	Code	H (cm)	C (cm)	☐
S	L4091601	158-164	84-88	20
M	L4091602	164-170	92-96	20
L	L4091603	170-176	100-104	20
XL	L4091604	176-182	108-112	20
2XL	L4091605	182-188	116-120	20
3XL	L4091606	188-194	126-130	20

**2 SOFT-SHELL HOODED JACKETS**

• КУРТКИ СОФТШЕЛЛ С КАПЮШОНОМ • SOFTCOATINGJACKEN MIT KARUZE

**310**  
g/m<sup>2</sup>

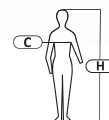
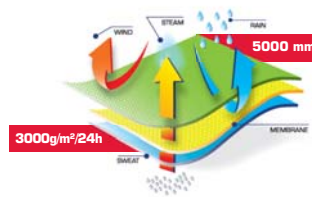
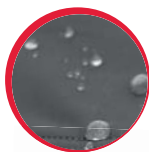

- MATERIAL: Coating: soft-shell textile, 94% polyester, 6% elastane, 310 g/m<sup>2</sup>. Lining: microfleece, 140 g/m<sup>2</sup>.
- Special 3-layer soft-shell textile with TPU membrane, water-proof (5000 mm), breathable (3000g/m<sup>2</sup>/24h), ensuring high comfort of use. Elastane in the textile guarantees flexibility, softness and strength. 4 zipped pockets, including a practical one on the sleeve. Detachable, width-adjustable hood. Water-proof zips to increase rain protection. Zip. Zip cover. Reflective components. Sleeves ended with a cuff with Velcro adjustment. Width adjustment at the jacket bottom with a special drawstring.
- NORM: EN ISO 13688

Size	Code	H (cm)	C (cm)	☐
S	LPKS2S	158-164	84-88	20
M	LPKS2M	164-170	92-96	20
L	LPKS2L	170-176	100-104	20
XL	LPKS2XL	176-182	108-112	20
2XL	LPKS22XL	182-188	116-120	20
3XL	LPKS23XL	188-194	126-130	20

**1 SOFT-SHELL JACKETS**

• КУРТКИ СОФТШЕЛЛ • SOFTCOATINGJACKEN

**310 g/m<sup>2</sup>**

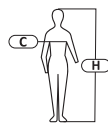
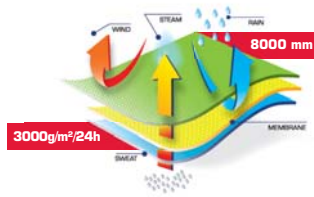
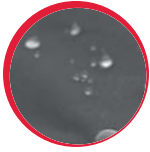

- MATERIAL: Coating: soft-shell textile, 96% polyester, 4% elastane, 310 g/ m<sup>2</sup>  
Lining: microfleece, 160 g/ m<sup>2</sup>.
- Special 3-layer soft-shell textile with TPU membrane, water-proof (8000 mm), breathable (3000g/ m<sup>2</sup>/24h), ensuring high comfort of use. Elastane in the textile guarantees flexibility, softness and strength. 5 pockets (3 outer, zipped and 2 inner). Wind-proof zips. Zip cover: A reflective component. Sleeves with Velcro adjustment. Width adjustment at the jacket bottom, with a special drawstring.
- NORM: EN ISO 13688

Size	Code	H (cm)	C (cm)	☐
S	L4090101	158-164	84-88	20
M	L4090102	164-170	92-96	20
L	L4090103	170-176	100-104	20
XL	L4090104	176-182	108-112	20
2XL	L4090105	182-188	116-120	20
3XL	L4090106	188-194	126-130	20

**2 SOFT-SHELL JACKETS**

• КУРТКИ СОФТШЕЛЛ • SOFTCOATINGJACKEN

**310 g/m<sup>2</sup>**

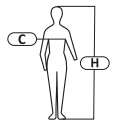
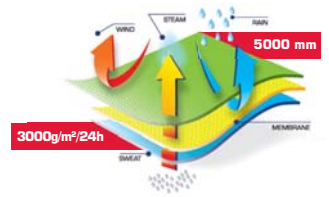

- MATERIAL: Coating: soft-shell textile, 94% polyester, 6% elastane, 310 g/ m<sup>2</sup>.  
Lining: microfleece, 150 g/ m<sup>2</sup>.
- Special 3-layer soft-shell textile with TPU membrane, water-proof (5000 mm), breathable (3000g/ m<sup>2</sup>/24h), ensuring high comfort of use. Elastane in the textile guarantees flexibility, softness and strength. 6 pockets (3 outer, zipped and 3 inner, including one for a mobile). Water-proof zips to increase rain protection. Zip cover: Reflective components. Sleeves ended with a cuff with Velcro adjustment. Width adjustment at the jacket bottom with a special drawstring.
- NORM: EN ISO 13688

Size	Code	H (cm)	C (cm)	☐
S	LPKS1S	158-164	84-88	20
M	LPKS1M	164-170	92-96	20
L	LPKS1L	170-176	100-104	20
XL	LPKS1XL	176-182	108-112	20
2XL	LPKS12XL	182-188	116-120	20
3XL	LPKS13XL	188-194	126-130	20

**1 LADIES' SOFT-SHELL HOODED JACKETS**

• КУРТКИ СООТШЕЛЛ С КАПОШНОМ ЖЕНСКИЕ • DAMENSOFTCOATINGJACKEN MIT KARUZE

**310 g/m<sup>2</sup>**

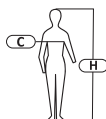
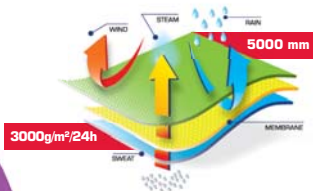

- MATERIAL: Coating: soft-shell textile, 96% polyester, 4% elastane, 310 g/m<sup>2</sup> Lining: microfleece, 160 g/m<sup>2</sup>.
- Special 3-layer soft-shell textile with TPU membrane, water-proof (5000 mm), breathable (3000g/m<sup>2</sup>/24h), ensuring high comfort of use. Elastane in the textile guarantees flexibility, softness and strength. 4 pockets (2 outer, zipped and 2 inner). Width-adjustable hood. Wind-proof zips. Zip. Zip cover: Reflective components. Sleeves with Velcro adjustment. Width adjustment at the jacket bottom with a special drawstring.
- NORM: EN ISO 13688

Size	Code	H (cm)	C (cm)	☐
S	L4090501	158-164	82-86	20
M	L4090502	164-170	88-92	20
L	L4090503	170-176	94-98	20
XL	L4090504	170-176	100-104	20
2XL	L4090505	176-182	106-110	20
3XL	L4090506	176-182	112-116	20

**2 LADIES' SOFT-SHELL JACKETS**

• КУРТКИ СООТШЕЛЛ ЖЕНСКИЕ • DAMENSOFTCOATINGJACKEN

**310 g/m<sup>2</sup>**

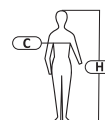
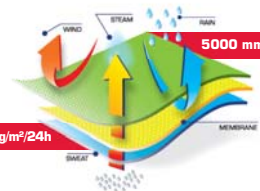

- MATERIAL: Coating: soft-shell textile, 96% polyester, 4% elastane, 310 g/m<sup>2</sup>. Lining: microfleece, 160 g/m<sup>2</sup>.
- Special 3-layer soft-shell textile with TPU membrane, water-proof (5000 mm), breathable (3000g/m<sup>2</sup>/24h), ensuring high comfort of use. Elastane in the textile guarantees flexibility, softness and strength. 4 pockets (2 outer, zipped and 2 inner). Wind-proof zips. Zip. Zip cover: Reflective components. Sleeves with Velcro adjustment. Width adjustment at the jacket bottom with a special drawstring.
- NORM: EN ISO 13688

Size	Code	H (cm)	C (cm)	☐
S	L4090401	158-164	82-86	20
M	L4090402	164-170	88-92	20
L	L4090403	170-176	94-98	20
XL	L4090404	170-176	100-104	20
2XL	L4090405	176-182	106-110	20
3XL	L4090406	176-182	112-116	20

**3 JACKETS**

• КУРТКА • JACKEN

**70 g/m<sup>2</sup>**

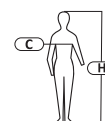

- MATERIAL: Shell: 100% polyester taffeta 210T coated with PA, Lining: 190T polyester.
- The lightweight, waterproof fabric ensures comfortable use. Watertight seams. 3 pockets (2 outer with a zipper and 1 inner). Windproof zippers. Zipper cover: Waterproof, adjustable hood, hidden in a Velcro collar. Cuffs finished with an elastic welt that provides protection against wind and water. Ventilation openings in the jacket's back improve air circulation. Jacket bottom width adjustment with a double-sided, lockable drawstring.
- NORM: EN ISO 13688

Size	Code	H (cm)	C (cm)	☐
S	L4092101	158-164	84-88	20
M	L4092102	164-170	92-96	20
L	L4092103	170-176	100-104	20
XL	L4092104	176-182	108-112	20
2XL	L4092105	182-188	116-120	20
3XL	L4092106	188-194	126-130	20

**1 WATERPROOF JACKETS**

• КУРТКИ ПРОТИВОДОЖДЕВЫЕ • REGENJACKEN

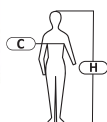

Kat. I  
Cat. I

- MATERIAL: 100% polyurethane
- The lightweight material used (100% Polyurethane) ensures comfortable use, increases durability and provides resistance to mechanical damage. Ventilation openings under the arms improve air circulation. Waterproof, adjustable hood, hidden in the zippered collar. Cuffs finished with an inner, elastic welt, which provides protection against wind and water. Jacket bottom width adjustment with a welt. Zipper with additional flap fastened with press studs. 2 outer pockets.
- NORM: EN ISO 13688

Size	Code	Colour	Code	Colour	H (cm)	C (cm)	☐
S	L4091701	■	L4091801	■	158-164	84-88	10
M	L4091702	■	L4091802	■	164-170	92-96	10
L	L4091703	■	L4091803	■	170-176	100-104	10
XL	L4091704	■	L4091804	■	176-182	108-112	10
2XL	L4091705	■	L4091805	■	182-188	116-120	10
3XL	L4091706	■	L4091806	■	188-194	126-130	10

**2 WATERPROOF TROUSERS**

• БРЮКИ ПРОТИВОДОЖДЕВЫЕ • REGENHOSEN

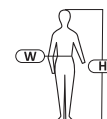

Kat. I  
Cat. I

- MATERIAL: 100% polyurethane
- The lightweight material used (100% Polyurethane) ensures comfortable use, increases durability and provides resistance to mechanical damage. Waist adjustable with a welt. Pant leg width adjustable with a zipper. 2 side openings for access to the pocket.
- NORM: EN ISO 13688

Size	Code	Colour	Code	Colour	H (cm)	W (cm)	☐
S	L4101001	■	L4101101	■	158-164	74-78	10
M	L4101002	■	L4101102	■	164-170	82-86	10
L	L4101003	■	L4101103	■	170-176	98-102	10
XL	L4101004	■	L4101104	■	176-182	108-112	10
2XL	L4101005	■	L4101105	■	182-188	106-110	10
3XL	L4101006	■	L4101106	■	188-194	116-120	10

**3 RAIN SETS (JACKETS, PANTS)**

• КОМПЛЕКТЫ ПРОТИВОДОЖДЕВЫЕ (КУРТКИ, БРЮКИ) • REGENSETS (JACKEN, HOSEN)

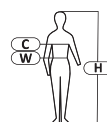

Kat. I  
Cat. I

- MATERIAL: PVC, polyester
- **Jackets:** Watertight seams. Ventilation openings under the arms and on the back improve air circulation. Waterproof, adjustable hood, hidden in the zippered collar. Cuffs finished with an inner, elastic welt, which provides protection against wind and water. Jacket bottom width adjustment with a welt. 2 outer pockets.
- **Pants:** Watertight seams. Waist adjustable with a welt. Pant leg width adjustable with. Snap fasteners 2 side openings for access to the pocket.
- NORM: EN ISO 13688

Size	Code	Colour	Code	Colour	Code	Colour	H (cm)	C (cm)	W (cm)	☐
S	L4140101	■	L4140201	■	L4140801	■	158-164	84-88	74-78	20
M	L4140102	■	L4140202	■	L4140802	■	164-170	92-96	82-86	20
L	L4140103	■	L4140203	■	L4140803	■	170-176	100-104	90-94	20
XL	L4140104	■	L4140204	■	L4140804	■	176-182	108-112	98-102	20
2XL	L4140105	■	L4140205	■	L4140805	■	182-188	116-120	106-110	20
3XL	L4140106	■	L4140206	■	L4140806	■	188-194	126-130	116-120	20

**1 RAINCOATS**

• ПЛАЩИ-ДОЖДЕВИКИ • REGENMÄNTEL

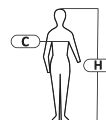

Kat. I  
Cat. I **CE**

- Material: PVC, polyester
- Waterproof seams. Ventilation openings under the arms and on the back improve air circulation. Waterproof, adjustable hood, hidden in the zippered collar: Cuffs finished with an inner; elastic welt, which provides protection against wind and water: Zipper with additional flap fastened with snap fasteners. 2 outer pockets
- NORM: EN ISO 13688

Size	Code	Colour	Code	Colour	Code	Colour	H [cm]	C [cm]	
S	L4170201		L4170301		L4170401		158-164	84-88	20
M	L4170202		L4170302		L4170402		164-170	92-96	20
L	L4170203		L4170303		L4170403		170-176	100-104	20
XL	L4170204		L4170304		L4170404		176-182	108-112	20
2XL	L4170205		L4170305		L4170405		182-188	116-120	20
3XL	L4170206		L4170306		L4170406		188-194	126-130	20

**2 RAINCOATS**

• ПЛАЩИ-ДОЖДЕВИКИ • REGENMÄNTEL

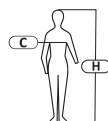

Kat. I  
Cat. I **CE**

- MATERIAL: 70% PVC, 30% polyester
- Sleeves with a cuff protecting from wind. Back and under arms ventilation. With a zip and snap fasteners. Two side pockets. Hood with straps. Water-proof textile. Unisex raincoat, both for men and women.
- NORM: EN ISO 13688

Size	Code	H [cm]	C [cm]	
M	LPPP1M	164-170	84-92	10
L	LPPP1L	170-176	92-100	10
XL	LPPP1XL	176-182	100-108	10
2XL	LPPP12XL	182-188	108-116	10

**3 RAINCOAT**

• ПЛАЩ-ДОЖДЕВИК • REGENMÄNTEL



Kat. I  
Cat. I **CE**

- MATERIAL: 100% polietylen.
- Unisex raincoat, for women and men. In a ziplock bag. Hood with drawstring. Snap fastening.
- NORM: EN ISO 13688

Size	Code	
one size	LPPPO1U	50/300

**4 "PONCHO" RAINCOATS**

• НАКИДКИ-ПОНЧО ПРОТИВОДОЖДЕВЬЕ • REGENMÄNTEL TYP „PONCHO“



Kat. I  
Cat. I **CE**

- MATERIAL: PVC.
- Hood with straps. Snap fastening.
- NORM: EN ISO 13688

Size	Code	Colour	
one size	LPPP11U		50
	LPPP12U		50



**1 PADDED VESTS**  
• БЕЗРУКАВКИ УТЕПЛЕННЫЕ • STEPPWESTEN

**70**  
g/m<sup>2</sup>  
POLYESTER  
COATING

**310**  
g/m<sup>2</sup>  
SOFT-SHELL  
COATING

**120**  
g/m<sup>2</sup>  
PADDING

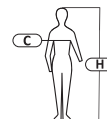
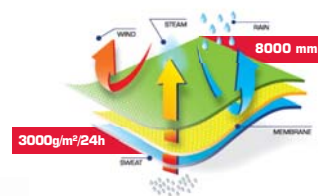

- MATERIAL: Coating: 100% polyester 70 g/m<sup>2</sup> and soft-shell textile, 96% polyester, 4% elastane, 310 g/m<sup>2</sup>. Padding: 120g/m<sup>2</sup>. Lining: taffeta 50 g/m<sup>2</sup> and microfleece 160 g/m<sup>2</sup>.
- Inserts from 3-ply soft-shell textile with TPU membrane, waterproof (8000 mm), breathable (3000g/m<sup>2</sup>/24 h), guaranteeing excellent wearing experience. 3 zipped pockets (2 outer and 1 inner one). Zip fastener: Zip cover: Width adjustment at the vest bottom with a special drawstring.
- NORM: EN ISO 13688

Size	Code	Colour	Code	Colour	Code	Colour	H (cm)	C (cm)	Box
S	L4130701	■	L4131001	■	L4131101	■	158-164	84-88	20
M	L4130702	■	L4131002	■	L4131102	■	164-170	92-96	20
L	L4130703	■	L4131003	■	L4131103	■	170-176	100-104	20
XL	L4130704	■	L4131004	■	L4131104	■	176-182	108-112	20
2XL	L4130705	■	L4131005	■	L4131105	■	182-188	116-120	20
3XL	L4130706	■	L4131006	■	L4131106	■	188-194	126-130	20

**1 PADDED VESTS**

• БЕЗРУКАВКИ УТЕПЛЁННЫЕ • WESTEN GEFÜTTERT

**155**  
g/m<sup>2</sup>  
COATING

**180**  
g/m<sup>2</sup>  
PADDING

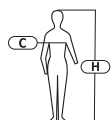





Kat. I  
Cat. I



- MATERIAL: Coating: 100% polyester, pognée type, 155 g/m<sup>2</sup>. Padding: 180 g/m<sup>2</sup>. Lining: taffeta, 50 g/m<sup>2</sup>.
- Waterproof, PVC-coated textile, preventing water absorption. 8 pockets (7 outer, including 4 zipped ones, and 1 inner). Mobile phone pocket. Key ring. Zip. Reflective components. Width adjustment at the bottom with a special drawstring. Arm openings finished inside with cuffs protecting from wind.
- NORM: EN ISO 13688

Size	Code	H (cm)	C (cm)	
S	LPBO1S	158-164	84-88	20
M	LPBO1M	164-170	92-96	20
L	LPBO1L	170-176	100-104	20
XL	LPBO1XL	176-182	108-112	20
2XL	LPBO12XL	182-188	116-120	20
3XL	LPBO13XL	188-194	126-130	20

**2 LADIES' FLEECE VESTS**

• ЖЕНСКИЕ ФЛИСОВЫЕ ЖИЛЕТЫ • DAMEN-FLEECE-WESTEN

**290**  
g/m<sup>2</sup>

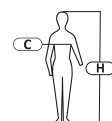



Kat. I  
Cat. I



- MATERIAL: High quality fleece, 100% polyester, 290 g/m<sup>2</sup>, short-cut, brushed on both sides and non pilling.
- 3 pockets, including one with a Velcro strap. Windproof zipper: Zipper cover.
- NORM: EN ISO 13688

Size	Code	H (cm)	C (cm)	
S	L4131201	158-164	82-86	20
M	L4131202	164-170	88-92	20
L	L4131203	170-176	94-98	20
XL	L4131204	170-176	100-104	20
2XL	L4131205	176-182	106-110	20
3XL	L4131206	176-182	112-116	20

**3 PADDED VEST**

• БЕЗРУКАВКИ УТЕПЛЁННЫЕ • WESTEN GEFÜTTERT

**160**  
g/m<sup>2</sup>  
COATING



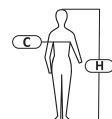









**160**  
g/m<sup>2</sup>  
PADDING

Kat. I  
Cat. I



- MATERIAL: Coating: 100% polyester; pognée type, 160 g/m<sup>2</sup>. Padding: 160 g/m<sup>2</sup>. Lining: taffeta 50 g/m<sup>2</sup>.
- PVC-covered textile, protecting against water infiltration. 3 zipped pockets. Zip fastener: Zip cover.
- NORM: EN ISO 13688

Size	Code	Colour	Code	Colour	H (cm)	C (cm)	
S	L4130801		L4130901		158-164	84-88	20
M	L4130802		L4130902		164-170	92-96	20
L	L4130803		L4130903		170-176	100-104	20
XL	L4130804		L4130904		176-182	108-112	20
2XL	L4130805		L4130905		182-188	116-120	20
3XL	L4130806		L4130906		188-194	126-130	20



**1 PADDED JACKETS WITH DETACHABLE SLEEVES**

• КУРТКИ СОФТШЕЛЛ С ОТСТЕГИВАЮЩИМИСЯ РУКАВАМИ • ISOLIERTE JACKEN MIT ABNEHMBAREN ÄRMELN

**275**  
g/m<sup>2</sup>  
COATING

**160**  
g/m<sup>2</sup>  
PADDING

**2 in 1**



Reflective stripes

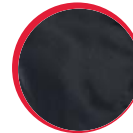

Abrasion-resistant fabric reinforcement

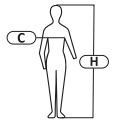

Kat. I  
Cat. I



- MATERIAL: Shell: 100% pongee polyester 275 g/m<sup>2</sup>. Insulation: 160 g/m<sup>2</sup>. Lining: taffeta 50 g/m<sup>2</sup>.
- Impregnated rip-stop fabric with a PVC coating, extremely durable and resistant to mechanical damage. 6 pockets, including 2 with zippers. Reflective strips that improve safety during work. Sleeves reinforced with an abrasion-resistant fabric (600D polyester). Removable sleeves. Double stitching. Insulated, adjustable hood, with zipper and Velcro fastening. Zipper with additional flap fastened with Velcro. Zipper cover. Sleeves finished with a welded cuff with Velcro strap. Jacket bottom width adjustment with an elastic band. Ventilation openings improve air circulation. Stylish and interesting design.
- NORM: EN ISO 13688

Size	Code	H [cm]	C [cm]	
S	L4092401	158-164	84-88	10
M	L4092402	164-170	92-96	10
L	L4092403	170-176	100-104	10
XL	L4092404	176-182	108-112	10
2XL	L4092405	182-188	116-120	10
3XL	L4092406	188-194	126-130	10

**2 PADDED TROUSERS**

• БРЮКИ УТЕПЛЁННЫЕ ДО ПОЯСА • ISOLIERTE HOSE BIS ZUR TAILLE

**275**  
g/m<sup>2</sup>  
COATING

**160**  
g/m<sup>2</sup>  
PADDING



Reflective stripes



Adjustable leg width



Abrasion-resistant fabric reinforcement



Knee pads for protective trousers and bibpants - see page 398

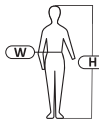

Kat. I  
Cat. I



- MATERIAL: Shell: 100% pongee polyester 275 g/m<sup>2</sup>. Insulation: 160 g/m<sup>2</sup>. Lining: taffeta 50 g/m<sup>2</sup>.
- Impregnated rip-stop fabric with a PVC coating, extremely durable and resistant to mechanical damage. 9 pockets, including 1 with a zipper. Reflective strips that improve safety during work. Knee protector pockets reinforced with an abrasion-resistant fabric (600D polyester). Triple-stitched seams. Adjustable waist with an elastic band. Key ring. 2 loops for a hammer. 2 tape measure holders. Belt loops. Bottom pant leg width adjustable with a zipper. Stylish and interesting design.
- NORM: EN ISO 13688

Size	Code	H [cm]	W [cm]	
S	L4101201	158-164	74-78	10
M	L4101202	164-170	82-86	10
L	L4101203	170-176	90-94	10
XL	L4101204	176-182	98-102	10
2XL	L4101205	182-188	106-110	10
3XL	L4101206	188-194	116-120	10

**3 PADDED BIB PANTS**

• ПОЛУКОМБИНЕЗОНЫ УТЕПЛЁННЫЕ • ISOLIERTE LATZHOSE

**275**  
g/m<sup>2</sup>  
COATING

**160**  
g/m<sup>2</sup>  
PADDING



Reflective stripes



Adjustable leg width



Special buckle construction to avoid self loosening



Knee pads for protective trousers and bibpants - see page 398

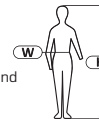

Kat. I  
Cat. I



- MATERIAL: Shell: 100% pongee polyester 275 g/m<sup>2</sup>. Insulation: 160 g/m<sup>2</sup>. Lining: taffeta 50 g/m<sup>2</sup>.
- Impregnated rip-stop fabric with a PVC coating, extremely durable and resistant to mechanical damage. 11 pockets, including 1 with a zipper. Reflective strips that improve safety during work. Knee protector pockets reinforced with an abrasion-resistant fabric (600D polyester). Triple-stitched seams. Adjustable waist with buttons and an elastic band. Key ring. 2 loops for a hammer. 2 tape measure holders. Adjustable-length braces. Bottom pant leg width adjustable with a zipper. Stylish and interesting design.
- NORM: EN ISO 13688

Size	Code	H [cm]	W [cm]	
S	L4110901	158-164	74-78	10
M	L4110902	164-170	82-86	10
L	L4110903	170-176	90-94	10
XL	L4110904	176-182	98-102	10
2XL	L4110905	182-188	106-110	10
3XL	L4110906	188-194	116-120	10

PROLINE

LAHTI PRO

MEGA

JUCCO

OTHER BRANDS

ERDI

KLINGSPOR

EXPRESS

ACTION CAN

TRYTON

VULCAN

### 1 PADDED JACKETS WITH DETACHABLE FLEECE

• КУРТКИ УТЕПЛЕННЫЕ С ОТСТЕГИВАЮЩИМСЯ ФЛИСОМ • GEFÜTTERTE JACKEN MIT ABNEHMBARER FLEECE

275 g/m<sup>2</sup> COATING

3in1

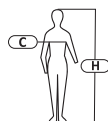

Kat. I  
Cat. I



- MATERIAL: Coating: 100% polyester, pogne type, 275 g/m<sup>2</sup>. Lining: taffeta, 50 g/m<sup>2</sup>. Detachable lining: taffeta, 280 g/m<sup>2</sup>.
- Waterproof rip-stop textile, PVC-coated, strong and resistant to mechanical damage. 7 pockets: jacket – 3 outer, zipped, and 2 inner: fleece lining – 2 outer, zipped, and 1 inner: Hood hidden in a collar fastened with Velcro. Double hood adjustment (width and depth). Zipped ventilation openings with mesh. Watertight zips and seams. A zip with an extra flap with Velcros and snap fasteners. Zip cover: Width adjustment at the jacket and fleece lining bottom with a special drawstring. Reflective components. Sleeves with Velcro fastening.
- NORM: EN ISO 13688

Size	Code	H [cm]	C [cm]	
S	LPKZ2S	158-164	84-88	10
M	LPKZ2M	164-170	92-96	10
L	LPKZ2L	170-176	100-104	10
XL	LPKZ2XL	176-182	108-112	10
2XL	LPKZ22XL	182-188	116-120	10
3XL	LPKZ23XL	188-194	126-130	10

### 2 PADDED BIB PANTS

• ПОЛУКОМБИНЕЗОНЫ УТЕПЛЕННЫЕ • LATZHOSEN GEFÜTTERT

275 g/m<sup>2</sup> COATING

160 g/m<sup>2</sup> PADDING



Adjustable leg width



Special buckle construction to avoid loosening

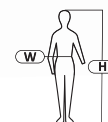

Kat. I  
Cat. I



- MATERIAL: Coating: 100% polyester, pongee type, 275 g/m<sup>2</sup>. Padding: density 160 g/m<sup>2</sup>. Lining: taffeta, 50 g/m<sup>2</sup>.
- Waterproof rip-stop textile, PVC-covered, strong and resistant to mechanical damage. 7 pockets, including 1 zipped. Mobile phone pocket. Waist width adjustment with a rubber band. Zip with extra flap with Velcro. Reflective components. Adjustable braces. Leg width adjustment at the bottom with a zip.
- NORM: EN ISO 13688

Size	Code	H [cm]	W [cm]	
S	L4110801	158-164	74-78	10
M	L4110802	164-170	82-86	10
L	L4110803	170-176	90-94	10
XL	L4110804	176-182	98-102	10
2XL	L4110805	182-188	106-110	10
3XL	L4110806	188-194	116-120	10

**1 PADDED JACKETS**

• КУРТКИ УТЕПЛЁННЫЕ • JAKEN GEFÜTTERT

**200**  
g/m<sup>2</sup>  
COATING

**200**  
g/m<sup>2</sup>  
PADDING

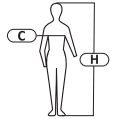

Kat. I  
Cat. I



- MATERIAL: Coating: 100% polyester, 600D Oxford, 200 g/m<sup>2</sup>. Padding: 200 g/m<sup>2</sup>. Lining: fleece 260 g/m<sup>2</sup> and taffeta, 50 g/m<sup>2</sup>.
- Strong, Waterproof PU textile. 10 pockets (9 outer, including 3 zipped and 1 inner). Mobile phone pocket. Padded adjustable hood, zip-fastened. Zip with extra flap with snap fasteners. Watertight zip. Reflective elements. Sleeves ended with cuff with Velcro adjustment. Width adjustment at the jacket bottom with a special drawstring. Ventilation openings to increase air circulation.
- NORM: EN ISO 13688

Size	Code	H (cm)	C (cm)	
S	<b>LPKZ1S</b>	158-164	84-88	10
M	<b>LPKZ1M</b>	164-170	92-96	10
L	<b>LPKZ1L</b>	170-176	100-104	10
XL	<b>LPKZ1XL</b>	176-182	108-112	10
2XL	<b>LPKZ12XL</b>	182-188	116-120	10
3XL	<b>LPKZ13XL</b>	188-194	126-130	10

**2 PADDED TROUSERS**

• БРЮКИ УТЕПЛЁННЫЕ • HOSEN GEFÜTTERT

**200**  
g/m<sup>2</sup>  
COATING

**160**  
g/m<sup>2</sup>  
PADDING



Adjustable leg width

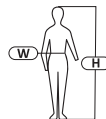

Kat. I  
Cat. I



- MATERIAL: Coating: 100% polyester, 600D Oxford, 200 g/m<sup>2</sup>. Padding: 160 g/m<sup>2</sup>. Lining: taffeta 50 g/m<sup>2</sup>.
- Strong waterproof, PU-covered textile, 7 pockets, including 4 with Velcro fastening. Waist width adjustment with a rubber band. Belt loops. Reflective components. Leg width adjustment at the bottom with a zip.
- NORM: EN ISO 13688

Size	Code	H (cm)	W (cm)	
S	<b>L4100701</b>	158-164	74-78	10
M	<b>L4100702</b>	164-170	82-86	10
L	<b>L4100703</b>	170-176	90-94	10
XL	<b>L4100704</b>	176-182	98-102	10
2XL	<b>L4100705</b>	182-188	106-110	10
3XL	<b>L4100706</b>	188-194	116-120	10

**3 PADDED BIB PANTS**

• ПОЛУКОМБИНЕЗОНЫ УТЕПЛЁННЫЕ • LATZHOSEN GEFÜTTERT

**200**  
g/m<sup>2</sup>  
COATING

**160**  
g/m<sup>2</sup>  
PADDING



Adjustable leg width



Special buckle construction to avoid self loosening

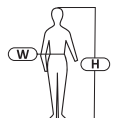

Kat. I  
Cat. I



- MATERIAL: Coating: 100% polyester, 600D Oxford, 200 g/m<sup>2</sup>. Padding: 160 g/m<sup>2</sup>. Lining: taffeta 50 g/m<sup>2</sup>.
- Strong waterproof PU-covered textile, 6 pockets, including 3 with Velcro fastening. Mobile phone pocket. Waist width adjustment with a rubber band. Zip with extra flap with Velcro. Reflective components. Adjustable braces. Leg width adjustment at the bottom with a zip.
- NORM: EN ISO 13688

Size	Code	H (cm)	W (cm)	
S	<b>L4110101</b>	158-164	74-78	10
M	<b>L4110102</b>	164-170	82-86	10
L	<b>L4110103</b>	170-176	90-94	10
XL	<b>L4110104</b>	176-182	98-102	10
2XL	<b>L4110105</b>	182-188	106-110	10
3XL	<b>L4110106</b>	188-194	116-120	10

**1 QUILTED JACKETS**  
• СТЕГАНЫЕ КУРТКИ • STEPPJACKEN

**200**  
g/m<sup>2</sup>  
COATING

**450**  
g/pc  
PADDING

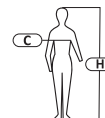

Kat. I  
Cat. I



- MATERIAL: Coating: 100% polyester rip-stop type, 200 g/m<sup>2</sup>. Padding: 450 g/pc. Lining: taffeta, 60 g/m<sup>2</sup>.
- Waterproof rip-stop textile, PVC-covered, extra strong and resistant to mechanical damage. 5 pockets (3 outer zipped and 2 inner; including 1 made from mesh). Pocket for a mobile phone/wallet. Padded hood with double adjustment (depth and width), attached by means of a zip and snap fasteners. Practical peak at the hood. Zip. Zip cover: Flexible inner cuffs, protecting from wind and cold. Width adjustment at the jacket bottom with a special drawstring.
- NORM: EN ISO 13688

Size	Code	H [cm]	C [cm]	
S	<b>L4090801</b>	158-164	84-88	10
M	<b>L4090802</b>	164-170	92-96	10
L	<b>L4090803</b>	170-176	100-104	10
XL	<b>L4090804</b>	176-182	108-112	10
2XL	<b>L4090805</b>	182-188	116-120	10
3XL	<b>L4090806</b>	188-194	126-130	10

**2 PADDED JACKETS**  
• КУРТКИ УТЕПЛЕННЫЕ • JAKKEN GEFÜTTERT

**140**  
g/m<sup>2</sup>  
COATING

**200**  
g/m<sup>2</sup>  
PADDING

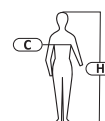

Kat. I  
Cat. I



- MATERIAL: Coating: 100% polyester, 300D Oxford, 140 g/m<sup>2</sup>. Padding: 200 g/m<sup>2</sup>. Lining: taffeta, 50 g/m<sup>2</sup>.
- Waterproof PU-covered textile. 7 pockets (6 outer; including 1 zipped and 1 inner). Padded, adjustable hood, attached by means of a zip and snap fasteners. A zip with extra flap with snap fasteners. Snap fasteners covered with plastic protecting from water. Flexible inner cuffs, protecting from wind and cold.
- NORM: EN ISO 13688

Size	Code	H [cm]	C [cm]	
S	<b>L4091501</b>	158-164	84-88	10
M	<b>L4091502</b>	164-170	92-96	10
L	<b>L4091503</b>	170-176	100-104	10
XL	<b>L4091504</b>	176-182	108-112	10
2XL	<b>L4091505</b>	182-188	116-120	10
3XL	<b>L4091506</b>	188-194	126-130	10

**1 PADDED JACKETS WITH DETACHABLE SLEEVES**

• КУРТКИ УТЕПЛЕННЫЕ С ОТСТЕГИВАЮЩИМИСЯ РУКАВАМИ • ISOLIERTE JACKEN MIT ABNEHMBAREN ÄRMELN

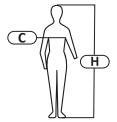

**120**  
g/m<sup>2</sup>

**180**  
g/m<sup>2</sup>  
PADDING

**Kat. I**  
**Cat. I** **CE**

- MATERIAL: Coating: 100% polyester, 200D Oxford, 120 g/m<sup>2</sup> polyuretane coated. Padding: 100% polyester, 180 g/m<sup>2</sup>. Lining: 190T polyester taffeta, 54 g/m<sup>2</sup>.
- Hood hidden in a collar fastened with Velcro. Sleeves ended with cuff with Velcro adjustment. Width adjustment at the jacket bottom with a welt, reflective elements. A zip with an extra flap with Velcro. Detachable sleeves. 5 pockets including one zipped (4 outer and 1 inner)
- NORM: EN ISO 13688

Size	Code	H (cm)	C (cm)	
S	<b>L4092701</b>	158-164	84-88	10
M	<b>L4092702</b>	164-170	92-96	10
L	<b>L4092703</b>	170-176	100-104	10
XL	<b>L4092704</b>	176-182	108-112	10
2XL	<b>L4092705</b>	182-188	116-120	10
3XL	<b>L4092706</b>	188-194	126-130	10



PROLINE

LAHTI PRO

MEGA

JUCCO

OTHER BRANDS

ERDI

KLINGSPOR

EXPRESS

ACTION CAN

TRAYTON

VULCAN

### 1 THERMOACTIVE SHIRTS

• ТЕРМОФУТБОЛКИ • THERMOAKTIVE UNTERHEMDEN

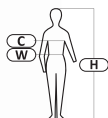

- MATERIAL: 72% polyamide, 21% polyester; 7% elastane.
- This honeycomb textile ensures perfect ventilation. Special weave absorbs moisture, removing it from the areas with increased perspiration. Cuffs guarantee perfect fit, ensuring comfort of wearing and protecting from cold. High-weave offers thermal protection.
- NORM: EN ISO 13688

Size	Code	H [cm]	C [cm]	W [cm]		
S/M	L4120101	158-175	86-96	64-86	x	40
L/XL	L4120103	175-185	98-108	76-98	x	40
2XL/3XL	L4120105	185-195	110-120	88-110	x	40

### 2 THERMOACTIVE PANTS

• ТЕРМОКАЛЬСОНЫ • THERMOAKTIVE LANGE UNTERHOSEN

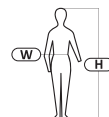

- MATERIAL: 72% polyamide, 21% polyester; 7% elastane.
- This honeycomb textile ensures perfect ventilation. Special weave absorbs moisture, removing it from the areas with increased perspiration. Cuffs guarantee perfect fit, ensuring comfort of wearing and protecting from cold. High-weave offers thermal protection.
- NORM: EN ISO 13688

Size	Code	H [cm]	W [cm]		
S/M	L4120201	158-175	64-86	x	40
L/XL	L4120203	175-185	76-98	x	40
2XL/3XL	L4120205	185-195	88-110	x	40

### 3 THERMAL SHIRTS

• ФУТБОЛКИ УТЕПЛЁННЫЕ • THERMONEMDEN

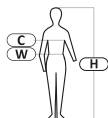

- MATERIAL: 35% cotton, 65% polyester.
- A combination of cotton (35%) and polyester (65%) ensures good breathing properties. Double-weave fabric ensures high heat insulation and the unique fabric brushing makes the product softer without compromising its durability. Sleeves ended with an elastic cuff.
- NORM: EN ISO 13688

Size	Code	H [cm]	C [cm]	W [cm]		
M	LPKT1M	170-175	99-104	84-89	x	72
L	LPKT1L	175-180	107-112	91-99	x	72
XL	LPKT1XL	180-185	114-119	102-107	x	72
XXL	LPKT12XL	185-190	122-127	110-115	x	72

### 4 THERMAL PANTS

• КАЛЬСОНЫ УТЕПЛЁННЫЕ • LANGE THERMOUNTERHOSEN

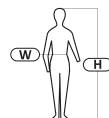

- MATERIAL: 35% cotton, 65% polyester.
- A combination of cotton (35%) and polyester (65%) ensures good breathing properties. Double-weave fabric ensures high heat insulation and the unique fabric brushing makes the product softer without compromising its durability. Legs ended with a cuff.
- NORM: EN ISO 13688

Size	Code	H [cm]	W [cm]		
M	LPKA1M	170-175	84-89	x	72
L	LPKA1L	170-175	91-99	x	72
XL	LPKA1XL	175-180	102-107	x	72
XXL	LPKA12XL	180-185	110-115	x	72

**1 LONG THERMAL WORK SOCKS**

• ТЕРМОНОСКИ РАБОЧИЕ, ДЛИННЫЕ • THERMOARBEITSSOCKEN LANG

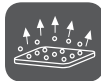

COOL MAX®

- MATERIAL: 38% cotton, 38% polyester (Coolmax®), 20% polyester; 4% elastane.
- Coolmax fibres ensure high breathability and fast moisture evaporation. Areas with special weave provide extra warmth to the feet and shin. Ended with a cuff. Fit the feet perfectly.

Size	Code		
39-42	<b>L3090639</b>	x	10/100
43-46	<b>L3090643</b>	x	10/100

**2 THERMAL WORK SOCKS**

• ТЕРМОНОСКИ РАБОЧИЕ • THERMOARBEITSSOCKEN



COOL MAX®

- MATERIAL: 60% cotton, 30% polyester (Coolmax®), 5% polyamide, 5% elastane.
- The use of Coolmax fibres ensures high breathability and quick moisture evaporation. Flexible zones with a special weave keep the socks in place. Ended with a cuff. Fit the feet perfectly.

Size	Code		
39-42	<b>L3090539</b>	x	10/100
43-46	<b>L3090543</b>	x	10/100

**3 WORK SOCKS**

• НОСКИ РАБОЧИЕ • ARBEITSSOCKEN

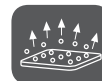

- MATERIAL: 80% cotton, 15% polyester, 3% polyamide, 2% elastane.
- Ended with a cuff. Fit the feet perfectly.

Size	Code		
39-42	<b>L3090439</b>	x	10/100
43-46	<b>L3090443</b>	x	10/100

**4 THERMAL WORK SOCKS, EXTRA THICK**

• НОСКИ РАБОЧИЕ УТЕПЛЕННЫЕ, ОЧЕНЬ ТОЛСТЫЕ • GEFÜTTERTER ARBEITSSOCKEN DICK



- MATERIAL: 91% acrylic, 5% nylon, 3% polyester, 1% elastane.
- The use of acrylic weave offers great thermal properties and softness. Ended with a cuff.

Size	Code		
39-42	<b>L3090339</b>	x	10/80
43-46	<b>L3090343</b>	x	10/80

**5 WORK SOCKS MEDIUM-THICK**

• НОСКИ РАБОЧИЕ СРЕДНЕЙ ТОЛЩИНЫ • ARBEITSSOCKEN MITTLERE DICKE

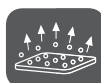

- MATERIAL: 50% cotton, 45% polyester, 5% elastane.
- Ended with a cuff. Fit the feet perfectly.

Size	Code		
39-42	<b>L3090239</b>	x	10/60
43-46	<b>L3090243</b>	x	10/60

**6 THIN WORK SOCKS**

• НОСКИ РАБОЧИЕ ТОНКИЕ • ARBEITSSOCKEN DÜNN



- MATERIAL: 75% cotton, 20% polyester, 5% elastane.
- Ended with a cuff. Fit the feet perfectly.

Size	Code		
39-42	<b>L3090139</b>	x	10/80
43-46	<b>L3090143</b>	x	10/80

**7 WORK SOCKS**

• НОСКИ РАБОЧИЕ • ARBEITSSOCKEN



- MATERIAL: 80% cotton, 17% polyester, 3% elastane.
- Ended with a cuff. Fit the feet perfectly.

Size	Code		
39-42	<b>L3090739</b>	x	10/80
43-46	<b>L3090743</b>	x	10/80

**8 SHORT WORK SOCKS**

• НОСКИ РАБОЧИЕ КОРОТКИЕ • ARBEITSSOCKEN KURZ



- MATERIAL: 80% cotton, 17% polyester, 3% elastane.
- Ended with a cuff. Fit the feet perfectly.

Size	Code		
39-42	<b>L3090839</b>	x	10/80
43-46	<b>L3090843</b>	x	10/80

**1 HIGH VISIBILITY JACKETS, SLIM FIT, SLIM FIT**

• СИГНАЛЬНЫЕ КУРТКИ, SLIM FIT • WARNJACKEN, SLIM FIT

**270**  
g/m<sup>2</sup>

**CLASS**  
**1**

CERTYFIKAT  
**CIOP - PIB**

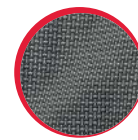

Reinforcements



Additional reflective elements

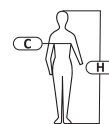

- MATERIAL: 35% cotton, 65% polyester; 270 g/m<sup>2</sup>; 60% cotton, 40% polyester; 270 g/m<sup>2</sup>
- Double-stitched reflective strips in accordance with EN ISO 20471. Additional reflective inserts that increase safety during work. 5 pockets, including 2 with zippers. Triple-stitched seams. Neck and pockets reinforced with an abrasion-resistant fabric (500D polyester). Bottom of the jacket and sleeves adjustable with Velcro straps. Slim fit. Stylish and interesting design. ID insert.
- NORM: EN ISO 13688, EN ISO 20471

Size	Code	Colour	Code	Colour	H (cm)	C (cm)	☐
S	L4041101	Yellow	L4041201	Orange	158-164	84-88	20
M	L4041102	Yellow	L4041202	Orange	164-170	92-96	20
L	L4041103	Yellow	L4041203	Orange	170-176	100-104	20
XL	L4041104	Yellow	L4041204	Orange	176-182	108-112	20
2XL	L4041105	Yellow	L4041205	Orange	182-188	116-120	20
3XL	L4041106	Yellow	L4041206	Orange	188-194	126-130	20

PROLINE

LAHTI PRO

MEGA

JUCO

OTHER BRANDS

ERDI

KLINGSPOR

EXPRESS

ACTION CAN

TRYTON

VULCAN



**1 HIGH VISIBILITY TROUSERS, SLIM FIT, SLIM FIT**

• СИГНАЛЬНЫЕ БРЮКИ, SLIM FIT • WARNHOSE, SLIM FIT

**270**  
g/m<sup>2</sup>

**CLASS**  
**1**

CERTYFIKAT  
**CIOP – PIB**

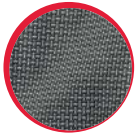

Reinforcements



Reflective elements



Innovative waist width regulation



Knee pads for protective trousers and bibpants  
- see page 398

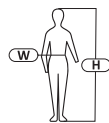

**Kat. II**  
**Cat. II**



- MATERIAL: 35% cotton, 65% polyester; 270 g/m<sup>2</sup>; 60% cotton, 40% polyester; 270 g/m<sup>2</sup>
- Reflective strips in accordance with EN ISO 20471. 8 pockets, including 1 with a zipper. Pocket for mobile phone. Additional reflective inserts that increase safety during work. Triple-stitched seams. Additional reinforcement of seams in the crotch area. Innovative width adjustment in the waist by means of a special structure with an elastic band. Loop for a hammer. Belt loops. Knee protector pockets reinforced with an abrasion-resistant fabric (500D polyester). Slim fit. Stylish and interesting design. ID insert.
- NORM: EN ISO 13688, EN ISO 20471

Size	Code	Colour	Code	Colour	H (cm)	W (cm)	☐
S	L4051101	Yellow	L4051201	Orange	158-164	74-78	20
M	L4051102	Yellow	L4051202	Orange	164-170	82-86	20
L	L4051103	Yellow	L4051203	Orange	170-176	90-94	20
XL	L4051104	Yellow	L4051204	Orange	176-182	98-102	20
2XL	L4051105	Yellow	L4051205	Orange	182-188	106-110	20
3XL	L4051106	Yellow	L4051206	Orange	188-194	116-120	20

**2 HIGH VISIBILITY BIB PANTS, SLIM FIT, SLIM FIT**

• СИГНАЛЬНЫЕ ПОЛУКОМБИНЕЗОНЫ, SLIM FIT • WARNLATZHOSE, SLIM FIT

**270**  
g/m<sup>2</sup>

**CLASS**  
**1**

CERTYFIKAT  
**CIOP – PIB**



Reinforcements



Reflective elements



Innovative waist width regulation



Special buckle construction to avoid loosening



Knee pads for protective trousers and bibpants  
- see page 398

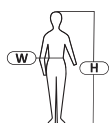

**Kat. II**  
**Cat. II**



- MATERIAL: 35% cotton, 65% polyester; 270 g/m<sup>2</sup>; 60% cotton, 40% polyester; 270 g/m<sup>2</sup>
- Reflective strips in accordance with EN ISO 20471. 9 pockets, including 1 with a zipper. Pocket for mobile phone. Additional reflective inserts that increase safety during work. Triple-stitched seams. Additional reinforcement of seams in the crotch area. Innovative width adjustment in the waist by means of a special structure with an elastic band. Loop for a hammer. Adjustable-length braces. Knee protector pockets reinforced with an abrasion-resistant fabric (500D polyester). Slim fit. Stylish and interesting design. ID insert.
- NORM: EN ISO 13688, EN ISO 20471

Size	Code	Colour	Code	Colour	H (cm)	W (cm)	☐
S	L4061001	Yellow	L4061101	Orange	158-164	74-78	20
M	L4061002	Yellow	L4061102	Orange	164-170	82-86	20
L	L4061003	Yellow	L4061103	Orange	170-176	90-94	20
XL	L4061004	Yellow	L4061104	Orange	176-182	98-102	20
2XL	L4061005	Yellow	L4061105	Orange	182-188	106-110	20
3XL	L4061006	Yellow	L4061106	Orange	188-194	116-120	20

PROLINE

LAHTI PRO

MEGA

JUCO

OTHER BRANDS

ERDI

KLINGSPOR

EXPRESS

ACTION CAN

TRYTON

VULCAN

**1 HIGH VISIBILITY PREMIUM JACKETS**

• КУРТКИ СИГНАЛЬНЫЕ, ПРЕМИУМ • WARNSCHUTZHOSEN, PREMIUM

CERTYFIKAT  
**CIOP – PIB**

**270**  
g/m<sup>2</sup>

**CLASS**  
**2**

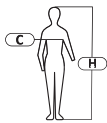

Kat. II  
Cat. II

- MATERIAL: 60% cotton, 40% polyester; 270 g/m<sup>2</sup>.
- Reflective stripes according to EN ISO 20471. High visibility grade: grade 2. Double seams. Zip. Adjustable cuffs with snap fasteners. Jacket bottom adjustable with snap fasteners. Snap fasteners coated with plastic protecting from water. 7 pockets, including 3 with Velcro fasteners. Mobile phone pocket. ID insert.
- NORM: EN ISO 13688, EN ISO 20471

Size	Code	Colour	Code	Colour	H (cm)	C (cm)	☐
S	L4091201	Yellow	L4091101	Orange	158-164	84-88	20
M	L4091202	Yellow	L4091102	Orange	164-170	92-96	20
L	L4091203	Yellow	L4091103	Orange	170-176	100-104	20
XL	L4091204	Yellow	L4091104	Orange	176-182	108-112	20
2XL	L4091205	Yellow	L4091105	Orange	182-188	116-120	20
3XL	L4091206	Yellow	L4091106	Orange	188-194	126-130	20

**2 HIGH VISIBILITY PREMIUM TROUSERS**

• БРЮКИ СИГНАЛЬНЫЕ, ПРЕМИУМ • WARNSCHUTZHOSE, PREMIUM

CERTYFIKAT  
**CIOP – PIB**

**270**  
g/m<sup>2</sup>

**CLASS**  
**2**



Knee pads for protective trousers and bibpants - see page 398

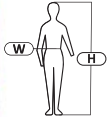

Kat. II  
Cat. II

CE

- MATERIAL: 60% cotton, 40% polyester; 270 g/m<sup>2</sup>.
- Reflective stripes to EN ISO 20471. High visibility grade: grade 2. Double seams. Waist adjustment with a drawstring. Belt loops. Snap fastener coated with plastic to protect from water. 10 pockets, including 4 with Velcro fasteners. Knee-pad pockets with Velcro fasteners. Hammer loop. ID insert.
- NORM: EN ISO 13688, EN ISO 20471

Size	Code	Colour	Code	Colour	H (cm)	W (cm)	☐
S	L4100601	Yellow	L4100501	Orange	158-164	74-78	20
M	L4100602	Yellow	L4100502	Orange	164-170	82-86	20
L	L4100603	Yellow	L4100503	Orange	170-176	90-94	20
XL	L4100604	Yellow	L4100504	Orange	176-182	98-102	20
2XL	L4100605	Yellow	L4100505	Orange	182-188	106-110	20
3XL	L4100606	Yellow	L4100506	Orange	188-194	116-120	20

**3 HIGH VISIBILITY PREMIUM BIB PANTS**

• ПОЛУКОМБИНЕЗОНЫ СИГНАЛЬНЫЕ, ПРЕМИУМ • WARNSCHUTZLATZHOSEN, PREMIUM

CERTYFIKAT  
**CIOP – PIB**

**270**  
g/m<sup>2</sup>

**CLASS**  
**3**



Special buckle construction to avoid self loosening



Knee pads for protective trousers and bibpants - see page 398

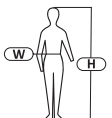

Kat. II  
Cat. II

CE

- MATERIAL: 60% cotton/ 40% polyester 270 g/m<sup>2</sup>.
- Reflective stripes to EN ISO 20471. Highest visibility grade: grade 3. Double seams. Waist adjustment with buttons and a drawstring. Snap fasteners coated with plastic to protect from water. Adjustable braces. 11 pockets, including 5 with Velcro fastener. Knee-pad pockets with Velcro. Hammer loop. ID insert.
- NORM: EN ISO 13688, EN ISO 20471

Size	Code	Colour	Code	Colour	H (cm)	W (cm)	☐
S	L4110701	Yellow	L4110601	Orange	158-164	74-78	20
M	L4110702	Yellow	L4110602	Orange	164-170	82-86	20
L	L4110703	Yellow	L4110603	Orange	170-176	90-94	20
XL	L4110704	Yellow	L4110604	Orange	176-182	98-102	20
2XL	L4110705	Yellow	L4110605	Orange	182-188	106-110	20
3XL	L4110706	Yellow	L4110606	Orange	188-194	116-120	20

**1 HIGH VISIBILITY JACKETS**

• КУРТКИ СИГНАЛЬНЫЕ • WARNSCHUTZJACKEN

CERTYFIKAT  
**CIOP - PIB**

**270**  
g/m<sup>2</sup>

**CLASS**  
**2**

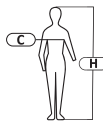

Kat. II  
Cat. II

- MATERIAL: 40% cotton, 60% polyester, 270 g/m<sup>2</sup>.
- Reflective stripes according to EN ISO 20471. High visibility grade: grade 2. Double seams. Ended with a collar. Buttoned-up. 5 pockets, including 2 with Velcro fasteners. Mobile phone pockets. ID insert.
- NORM: EN ISO 13688, EN ISO 20471

Size	Code	Colour	Code	Colour	H [cm]	C [cm]	
S	L4091001	Yellow	L4090901	Orange	158-164	84-88	20
M	L4091002	Yellow	L4090902	Orange	164-170	92-96	20
L	L4091003	Yellow	L4090903	Orange	170-176	100-104	20
XL	L4091004	Yellow	L4090904	Orange	176-182	108-112	20
2XL	L4091005	Yellow	L4090905	Orange	182-188	116-120	20
3XL	L4091006	Yellow	L4090906	Orange	188-194	126-130	20

**2 HIGH VISIBILITY TROUSERS**

• БРЮКИ СИГНАЛЬНЫЕ • WARNSCHUTZHOSEN

CERTYFIKAT  
**CIOP - PIB**

**270**  
g/m<sup>2</sup>

**CLASS**  
**2**

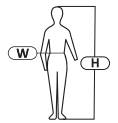

Kat. II  
Cat. II

- MATERIAL: 40% cotton, 60% polyester, 270 g/m<sup>2</sup>.
- Reflective stripes to EN ISO 20471. High visibility grade: grade 2. Double seams. Waist adjustment with a drawstring. Belt loops. Snap fastener coated with plastic to protect from water. 6 pockets, including 2 with Velcro fasteners. ID insert.
- NORM: EN ISO 13688, EN ISO 20471

Size	Code	Colour	Code	Colour	H [cm]	W [cm]	
S	L4100401	Yellow	L4100301	Orange	158-164	74-78	20
M	L4100402	Yellow	L4100302	Orange	164-170	82-86	20
L	L4100403	Yellow	L4100303	Orange	170-176	90-94	20
XL	L4100404	Yellow	L4100304	Orange	176-182	98-102	20
2XL	L4100405	Yellow	L4100305	Orange	182-188	106-110	20
3XL	L4100406	Yellow	L4100306	Orange	188-194	116-120	20

**3 HIGH VISIBILITY BIB PANTS**

• ПОЛУКОМБИНЕЗОНЫ СИГНАЛЬНЫЕ • WARNSCHUTZLATZHOSEN

CERTYFIKAT  
**CIOP - PIB**

**270**  
g/m<sup>2</sup>

**CLASS**  
**2**



Specjalna konstrukcja klamry zapobiegająca jej zsuwaniu się

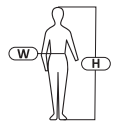

Kat. II  
Cat. II

- MATERIAL: 40% cotton, 60% polyester, 270 g/m<sup>2</sup>.
- Reflective stripes to EN ISO 20471. High visibility grade: grade 2. Double seams. Waist adjustment with buttons and a drawstring. Adjustable braces. 7 pockets, including 3 with Velcro fasteners. ID insert.
- NORM: EN ISO 13688, EN ISO 20471

Size	Code	Colour	Code	Colour	H [cm]	W [cm]	
S	L4110501	Yellow	L4110401	Orange	158-164	74-78	20
M	L4110502	Yellow	L4110402	Orange	164-170	82-86	20
L	L4110503	Yellow	L4110403	Orange	170-176	90-94	20
XL	L4110504	Yellow	L4110404	Orange	176-182	98-102	20
2XL	L4110505	Yellow	L4110405	Orange	182-188	106-110	20
3XL	L4110506	Yellow	L4110406	Orange	188-194	116-120	20

PROLINE  
LAHTI PRO  
MEGA  
JUCO  
OTHER BRANDS  
ERDI  
KLINGSPOR  
EXPRESS  
ACTION CAN  
TRYTON  
VULCAN

**1 HIGH VISIBILITY PADDED JACKETS**

• КУРТКИ СИГНАЛЬНЫЕ УТЕПЛЁННЫЕ • WARNSCHUTZJACKEN GEFÜTTERT

CERTYFIKAT  
**CIOP - PIB**

- 180**  
g/m<sup>2</sup>  
COATING
- 160**  
g/m<sup>2</sup>  
PADDING
- 
- 2000**  
mm
- CLASS 3**





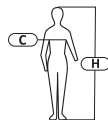









High grade quality waterproof material (2000 mm)



Kat. II  
Cat. II

- MATERIAL: Coating: 100% polyester Oxford 300D, 180 g/m<sup>2</sup> PU-coated. Padding: 100% polyester, 160 g/m<sup>2</sup>. Lining: 190T polyester, taffeta 54 g/m<sup>2</sup>.
- Highest visibility grade: grade 3. Reflective stripes according to EN ISO 20471. Watertight seams. Snap fasteners coated with plastic protecting from water. Waterproof adjustable hood, concealed in a collar. Inner flexible cuffs to protect from wind and cold. Width adjustment at the jacket bottom with a two-sided drawstring with a stop. A zip with extra flap with snap-fasteners. 7 pockets (4 outer ones, including one for a mobile and 3 inner). Ventilation openings to improve air circulation.
- NORM: EN ISO 13688, EN ISO 20471

Size	Code	Colour	Code	Colour	H (cm)	C (cm)	
S	L4090701		L4090601		158-164	84-88	10
M	L4090702		L4090602		164-170	92-96	10
L	L4090703		L4090603		170-176	100-104	10
XL	L4090704		L4090604		176-182	108-112	10
2XL	L4090705		L4090605		182-188	116-120	10
3XL	L4090706		L4090606		188-194	126-130	10

**2 HIGH VISIBILITY PADDED TROUSERS**

• БРЮКИ СИГНАЛЬНЫЕ УТЕПЛЁННЫЕ • WARNSCHUTZHOSEN GEFÜTTERT

CERTYFIKAT  
**CIOP - PIB**

- 180**  
g/m<sup>2</sup>  
COATING
- 160**  
g/m<sup>2</sup>  
PADDING
- 
- 2000**  
mm
- CLASS 2**

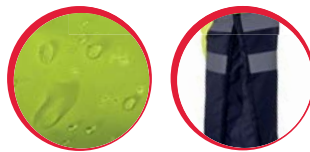



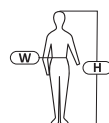









High grade quality waterproof material (2000 mm) Zip regulated leg width



Kat. II  
Cat. II

- MATERIAL: Coating: 100% polyester Oxford 300D, 180 g/m<sup>2</sup> PU-coated. Padding: 100% polyester, 160 g/m<sup>2</sup>. Lining: 190T polyester, taffeta 54 g/m<sup>2</sup>.
- High visibility grade: grade 2. Reflective stripes according to EN ISO 20471. Watertight seams. Waist width adjustment with a drawstring. Belt loops. A snap fastener coated with plastic to protect from water. 6 pockets.
- NORM: EN ISO 13688, EN ISO 20471

Size	Code	Colour	Code	Colour	H (cm)	W (cm)	
S	L4100201		L4100101		158-164	74-78	10
M	L4100202		L4100102		164-170	82-86	10
L	L4100203		L4100103		170-176	90-94	10
XL	L4100204		L4100104		176-182	98-102	10
2XL	L4100205		L4100105		182-188	106-110	10
3XL	L4100206		L4100106		188-194	116-120	10

### 1 HIGH VISIBILITY QUILTED BIB PANTS

• ПОЛУКОМБИНЕЗОНЫ СИГНАЛЬНЫЕ УТЕПЛЕННЫЕ • WARNSCHUTZLATZHOSEN GEFÜTTERT

**180**  
g/m<sup>2</sup>  
COATING

**160**  
g/m<sup>2</sup>  
PADDING



**CLASS**  
**3**

CERTYFIKAT  
**CIOP - PIB**



Special buckle construction to avoid self loosening



High grade quality waterproof material (2000 mm)



Zip regulated leg width

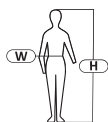

**Kat. II**  
**Cat. II** **CE**

- MATERIAL: Coating: 100% polyester Oxford 300D, 180 g/m<sup>2</sup> PU-coated. Padding: 100% polyester, 160 g/m<sup>2</sup>. Lining: 190T polyester, taffeta 54 g/m<sup>2</sup>.
- Highest visibility grade: grade 3. Reflective stripes according to EN ISO 20471. Watertight seams. Waist width adjustment with buttons and a drawstring. Adjustable braces. 5 pockets
- NORM: EN ISO 13688, EN ISO 20471

Size	Code	Colour	Code	Colour	H (cm)	W (cm)	☐
S	L4110301	Yellow	L4110201	Orange	158-164	74-78	10
M	L4110302	Yellow	L4110202	Orange	164-170	82-86	10
L	L4110303	Yellow	L4110203	Orange	170-176	90-94	10
XL	L4110304	Yellow	L4110204	Orange	176-182	98-102	10
2XL	L4110305	Yellow	L4110205	Orange	182-188	106-110	10
3XL	L4110306	Yellow	L4110206	Orange	188-194	116-120	10

### 2 HIGH VISIBILITY PADDED JACKETS WITH DETACHABLE SLEEVES

• СИГНАЛЬНЫЕ КУРТКИ УТЕПЛЕННЫЕ С ОТСТЕГИВАЮЩИМИСЯ РУКАВАМИ • ISOLIERTE WARNJACKEN MIT ABNEHMBAREN ÄRMELN

**180**  
g/m<sup>2</sup>  
COATING

**160**  
g/m<sup>2</sup>  
PADDING



**CLASS**  
**1**

CERTYFIKAT  
**CIOP - PIB**



High grade quality waterproof material (2000 mm)

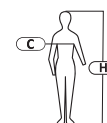

**180**  
g/m<sup>2</sup> **Kat. II**  
**Cat. II** **CE**

- Material: Coating: 100% Oxford polyester 300D 180 g/m<sup>2</sup> with polyurethane (PU) coating. Padding: 100% polyester 160 g/m<sup>2</sup>. Lining: 190T polyester taffeta 54 g/m<sup>2</sup>.
- Reflective strips in accordance with EN ISO 20471. Watertight seams. Waterproof, adjustable hood, hidden in a Velcro collar. Cuffs finished with a welt with Velcro strap adjustment. Jacket bottom width adjustment with a welt. Zipper with additional flap fastened snaps. Removable sleeves. 5 pockets, including 1 with a zipper (4 outer and 1 inner).
- NORM: EN ISO 13688, EN ISO 20471

Size	Code	Colour	Code	Colour	H (cm)	C (cm)	☐
S	L4092501	Yellow	L4092601	Orange	158-164	84-88	10
M	L4092502	Yellow	L4092602	Orange	164-170	92-96	10
L	L4092503	Yellow	L4092603	Orange	170-176	100-104	10
XL	L4092504	Yellow	L4092604	Orange	176-182	108-112	10
2XL	L4092505	Yellow	L4092605	Orange	182-188	116-120	10
3XL	L4092506	Yellow	L4092606	Orange	188-194	126-130	10

**1 HIGH VISIBILITY PADDED REVERSIBLE VESTS**

• ДВУСТОРОННИЕ СИГНАЛЬНЫЕ ЖИЛЕТЫ УТЕПЛЁННЫЕ • DOPPELSEITIGE, ISOLIERTE WARNWESTEN

CERTYFIKAT  
**CIOP – PIB**

**180**  
g/m<sup>2</sup>  
COATING

**160**  
g/m<sup>2</sup>  
PADDING



**CLASS**  
**1**



High grade quality waterproof material (2000 mm)

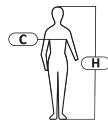

- Material: Coating: 100% Oxford polyester 300D 180 g/m<sup>2</sup> with polyurethane (PU) coating. Padding: 100% polyester 160 g/m<sup>2</sup>. Lining: Fleece 100% polyester 220 g/m<sup>2</sup>.
- Reflective strips in accordance with EN ISO 20471. Watertight seams. 6 pockets, including 5 with a zipper (3 outer and 2 inner). Vest bottom width adjustment with a special drawstring.
- NORM: EN ISO 13688, EN ISO 20471

Size	Code	Colour	Code	Colour	H (cm)	C (cm)	☐
S	L4131301	Yellow	L4131401	Orange	158-164	84-88	20
M	L4131302	Yellow	L4131402	Orange	164-170	92-96	20
L	L4131303	Yellow	L4131403	Orange	170-176	100-104	20
XL	L4131304	Yellow	L4131404	Orange	176-182	108-112	20
2XL	L4131305	Yellow	L4131405	Orange	182-188	116-120	20
3XL	L4131306	Yellow	L4131406	Orange	188-194	126-130	20

**2 HIGH VISIBILITY FLEECE JACKETS**

• КУРТКИ ФЛИСОВЫЕ СИГНАЛЬНЫЕ • КУРТКИ ФЛИСОВЫЕ СИГНАЛЬНЫЕ

CERTYFIKAT  
**CIOP – PIB**

**300**  
g/m<sup>2</sup>

**CLASS**  
**2**

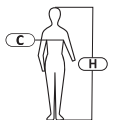

- MATERIAL: High-quality fleece 100% polyester, 300 g/m<sup>2</sup>, short pile, brushed bilaterally and anti-pilling.
- Reflective stripes EN ISO 20471 combined with a high-visibility fabric ensure high visibility grade: grade 2. 3 zipped pockets. Wind-tight zips. Width adjustment at the jacket bottom with a two-sided drawstring with a stop.
- NORM: EN ISO 13688, EN ISO 20471

Size	Code	Colour	Code	Colour	H (cm)	C (cm)	☐
S	L4010901	Yellow	L4011001	Orange	158-164	84-88	20
M	L4010902	Yellow	L4011002	Orange	164-170	92-96	20
L	L4010903	Yellow	L4011003	Orange	170-176	100-104	20
XL	L4010904	Yellow	L4011004	Orange	176-182	108-112	20
2XL	L4010905	Yellow	L4011005	Orange	182-188	116-120	20
3XL	L4010906	Yellow	L4011006	Orange	188-194	126-130	20



**1 HIGH VISIBILITY SOFT SHELL JACKETS WITH DETACHABLE SLEEVES**

• ПРЕДУПРЕЖДАЮЩИЕ КУРТКИ СООТШЕЛЛ С ОТСТЕГИВАЮЩИМИСЯ РУКАВАМИ  
• WARNSCHUTZSOFTCOATINGJACKEN MIT ABNEHMBAREN ÄRMELN

**320**  
g/m<sup>2</sup>

**CLASS**  
**1**

**2in1**

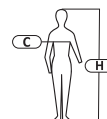
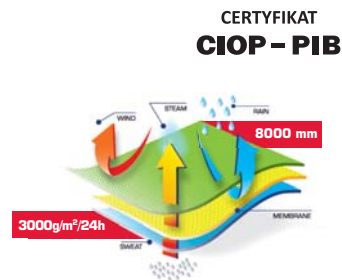
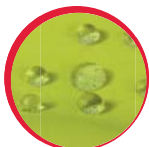

- MATERIAL: 100% polyester.
- Special 3-ply soft-shell textile with TPU membrane, waterproof (8000 mm), breathable (3000 g/m<sup>2</sup>/24 h), guaranteeing excellent wearing experience. Reflective stripes compliant with standard EN ISO 20471. 3 zipped pockets. Wind-proof zip fasteners. Detachable hood with width adjustment. Detachable sleeves. Zip cover. Sleeves finished with cuffs with Velcro adjustment. Width adjustment at the jacket bottom with a special drawstring.
- NORM: EN ISO 13688, EN ISO 20471

Size	Code	Colour	Code	Colour	H [cm]	C [cm]	☐
S	L4091901	Yellow	L4092201	Orange	158-164	84-88	20
M	L4091902	Yellow	L4092202	Orange	164-170	92-96	20
L	L4091903	Yellow	L4092203	Orange	170-176	100-104	20
XL	L4091904	Yellow	L4092204	Orange	176-182	108-112	20
2XL	L4091905	Yellow	L4092205	Orange	182-188	116-120	20
3XL	L4091906	Yellow	L4092206	Orange	188-194	126-130	20

### 1 HIGH VISIBILITY RAIN JACKETS

• КУРТКИ ПРОТИВОДОЖДЕВЫЕ СИГНАЛЬНЫЕ • WARNSCHUTZREGENJACKEN

180 g/m<sup>2</sup>



CLASS 3



High grade quality waterproof material (2000 mm)



CERTYFIKAT  
CIOP – PIB

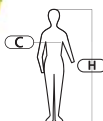

Kat. II  
Cat. II  
CE

- MATERIAL: 100% polyester; Oxford 300D, polyurethane (PU)-coated.
- Reflective stripes according to EN ISO 20471 combined with high-visibility textile ensure the highest visibility grade: grade 3. Watertight seams. Waterproof adjustable hood, concealed in a collar; zipped. Sleeves ended with a Velcro-adjustable cuff. Width adjustment at the jacket bottom with a drawstring. 2 outer pockets with snap fasteners. Ventilation openings on the jacket front and back to increase air circulation.
- NORM: EN ISO 13688, EN ISO 20471

Size	Code	Colour	Code	Colour	H (cm)	C (cm)	☐
S	L4091301	Yellow	L4091401	Orange	158-164	84-88	20
M	L4091302	Yellow	L4091402	Orange	164-170	92-96	20
L	L4091303	Yellow	L4091403	Orange	170-176	100-104	20
XL	L4091304	Yellow	L4091404	Orange	176-182	108-112	20
2XL	L4091305	Yellow	L4091405	Orange	182-188	116-120	20
3XL	L4091306	Yellow	L4091406	Orange	188-194	126-130	20

### 2 HIGH VISIBILITY RAIN TROUSERS

• БРЮКИ ПРОТИВОДОЖДЕВЫЕ СИГНАЛЬНЫЕ • WARNSCHUTZREGENHOSEN

180 g/m<sup>2</sup>



CLASS 2



High grade quality waterproof material (2000 mm)



CERTYFIKAT  
CIOP – PIB



Zip regulated leg width

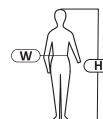

Kat. II  
Cat. II  
CE

- MATERIAL: 100% polyester; Oxford 300D, polyurethane (PU)-coated.
- Reflective stripes according to EN ISO 20471 combined with high-visibility fabric ensure high visibility grade: grade 2. Watertight seams. Width adjustment in the waist with a drawstring. Leg width adjustment with zip. 2 side openings enable to reach the pockets.
- NORM: EN ISO 13688, EN ISO 20471

Size	Code	Colour	Code	Colour	H (cm)	W (cm)	☐
S	L4100801	Yellow	L4100901	Orange	158-164	74-78	20
M	L4100802	Yellow	L4100902	Orange	164-170	82-86	20
L	L4100803	Yellow	L4100903	Orange	170-176	90-94	20
XL	L4100804	Yellow	L4100904	Orange	176-182	98-102	20
2XL	L4100805	Yellow	L4100905	Orange	182-188	106-110	20
3XL	L4100806	Yellow	L4100906	Orange	188-194	116-120	20

### 3 HIGH VISIBILITY RAINCOATS

• ПЛАЩИ-ДОЖДЕВИКИ СИГНАЛЬНЫЕ • WARNSCHUTZREGENMÄNTEL

180 g/m<sup>2</sup>

CLASS 3



High grade quality waterproof material (2000 mm)



CERTYFIKAT  
CIOP – PIB

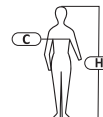

Kat. II  
Cat. II  
CE

- MATERIAL: 100% polyester; Oxford 300D, polyurethane (PU)-coated.
- Reflective stripes according to EN ISO 20471 combined with high-visibility fabric ensure the high visibility grade: grade 3. Watertight seams. Width adjustment in the waist with a drawstring. Zip regulated leg width. Two side openings enable to access pockets easily.
- NORM: EN ISO 13688, EN ISO 20471

Size	Code	H (cm)	C (cm)	Colour	☐
S	L4170101	158-164	84-88	Yellow	20
M	L4170102	164-170	92-96	Yellow	20
L	L4170103	170-176	100-104	Yellow	20
XL	L4170104	176-182	108-112	Yellow	20
2XL	L4170105	182-188	116-120	Yellow	20
3XL	L4170106	188-194	126-130	Yellow	20



**1 HIGH VISIBILITY POLO SHIRTS**

• ТЕННИСКИ СИГНАЛЬНЫЕ • WARNSCHUTZPOLOHEMDEN

CERTYFIKAT  
**CIOP – PIB**

**140**  
g/m<sup>2</sup>

**CLASS**  
**2**

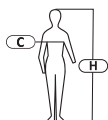

- MATERIAL: 100% Bird-eye polyester 140 g/m<sup>2</sup>.
- Reflective stripes to EN ISO 20471 combined with the high-visibility fabric ensure high visibility grade: grade 2. Bird-eye textile improving air circulation. Finished with a collar: Buttoned-up. Pocket. Nape tape ensuring extra reinforcement.
- NORM: EN ISO 13688, EN ISO 20471

Size	Code	Colour	Code	Colour	H (cm)	C (cm)	☐
S	L4030201	Yellow	L4030101	Orange	158-164	84-88	50
M	L4030202	Yellow	L4030102	Orange	164-170	92-96	50
L	L4030203	Yellow	L4030103	Orange	170-176	100-104	50
XL	L4030204	Yellow	L4030104	Orange	176-182	108-112	50
2XL	L4030205	Yellow	L4030105	Orange	182-188	116-120	50
3XL	L4030206	Yellow	L4030106	Orange	188-194	126-130	50

**2 HIGH VISIBILITY T-SHIRTS**

• ФУТБОЛКИ СИГНАЛЬНЫЕ • WARNSCHUTZ-T-SHIRTS

CERTYFIKAT  
**CIOP – PIB**

**140**  
g/m<sup>2</sup>

**CLASS**  
**2**

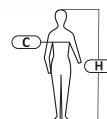

- MATERIAL: 100% Bird-eye polyester 140 g/m<sup>2</sup>.
- Reflective stripes EN ISO 20471 combined with a high-visibility fabric ensure high visibility grade: grade 2. Bird-eye fabric to increase air circulation. Tape on the nape provides extra strengthening.
- NORM: EN ISO 13688, EN ISO 20471

Size	Code	Colour	Code	Colour	H (cm)	C (cm)	☐
S	L4020801	Yellow	L4020701	Orange	158-164	84-88	50
M	L4020802	Yellow	L4020702	Orange	164-170	92-96	50
L	L4020803	Yellow	L4020703	Orange	170-176	100-104	50
XL	L4020804	Yellow	L4020704	Orange	176-182	108-112	50
2XL	L4020805	Yellow	L4020705	Orange	182-188	116-120	50
3XL	L4020806	Yellow	L4020706	Orange	188-194	126-130	50

**3 MESH VESTS WITH REFLECTIVE STRIPES**

• ЖИЛЕТЫ СЕТКА СО СВЕТООТРАЖАЮЩИМИ ПОЛОСАМИ • NETZWESTEN MIT REFLEXSTREIFEN

**120**  
g/m<sup>2</sup>

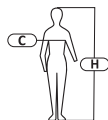
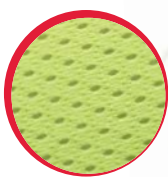

- MATERIAL: 100% polyester 120 g/m<sup>2</sup>.
- Velcro fasteners. Two reflective stripes. Mesh fabric structure ensures high breathability. Application: identification of people.

Size	Code	Colour	Code	Colour	H (cm)	C (cm)	☐
S	L4130501	Yellow	L4130601	Orange	158-164	86-90	100
M	L4130502	Yellow	L4130602	Orange	164-170	92-96	100
L	L4130503	Yellow	L4130603	Orange	170-176	100-104	100
XL	L4130504	Yellow	L4130604	Orange	176-182	108-112	100
2XL	L4130505	Yellow	L4130605	Orange	182-188	116-120	100
3XL	L4130506	Yellow	L4130606	Orange	188-194	126-130	100

**4 HIGH-VISIBILITY VESTS**

• ЖИЛЕТЫ СИГНАЛЬНЫЕ • WARNSCHUTZWESTEN

**120**  
g/m<sup>2</sup>

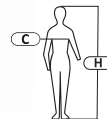

- MATERIAL: 100% polyester 120 g/m<sup>2</sup>.
- Velcro fasteners. Two reflective stripes.
- NORM: EN ISO 13688, EN ISO 20471

Size	Code	Colour	Code	Colour	H (cm)	C (cm)	☐
S	LPK01S	Yellow	LPK02S	Orange	158-164	84-88	100
M	LPK01M	Yellow	LPK02M	Orange	164-170	92-96	100
L	LPK01L	Yellow	LPK02L	Orange	170-176	100-104	100
XL	LPK01XL	Yellow	LPK02XL	Orange	176-182	108-112	100
2XL	LPK012XL	Yellow	LPK022XL	Orange	182-188	116-120	100
3XL	LPK013XL	Yellow	LPK023XL	Orange	188-194	126-130	100

PROLINE

LAHTI PRO

MEGA

JUCCO

OTHER BRANDS

ERDI

KLINGSPOR

EXPRESS

ACTION CAN

TRYTON

VULCAN

**1 HIGH-VISIBILITY VESTS FOR CHILDREN**

• ЖИЛЕТЫ СИГНАЛЬНЫЕ ДЕТСКИЕ • WARNSCHUTZWESTEN FÜR KINDER

**120**  
g/m<sup>2</sup>

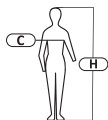

**Kat. II**  
**Cat. II** **CE**

- MATERIAL: 100% polyester 120 g/m<sup>2</sup>.
- Velcro fasteners. Two reflective stripes.
- NORM: EN 1150

Size/ Age category	Code	Colour	Code	Colour	H (cm)	C (cm)	
S/4-6 Years	L4130101		L4130201		120-134	75-85	100
M/7-9 Years	L4130102		L4130202		134-150	85-95	100
L/10-12 Years	L4130103		L4130203		150-165	95-105	100

**2 HIGH-VISIBILITY SHORTS**

• ШОРТЫ КОРОТКИЕ СИГНАЛЬНЫЕ • WARNHOSEN KURZ

**270**  
g/m<sup>2</sup>

**CLASS**  
**1**

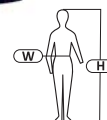

**Kat. II**  
**Cat. II** **CE**

- MATERIAL: 40% cotton, 60% polyester; 270 g/m<sup>2</sup>.
- Reflective stripes to EN ISO 20471. Visibility grade: 1. Waist width adjustment with a drawstring. Double seams. Belt loops. Snap fastener covered with plastic to protect from water: 4 pockets, including 2 with Velcro fastening. ID insert.
- NORM: EN ISO 13688, EN ISO 20471

Size	Code	Colour	Code	Colour	H (cm)	W (cm)	
S	L4070101		L4070201		158-164	74-78	20
M	L4070102		L4070202		164-170	82-86	20
L	L4070103		L4070203		170-176	90-94	20
XL	L4070104		L4070204		176-182	98-102	20
2XL	L4070105		L4070205		182-188	106-110	20
3XL	L4070106		L4070206		188-194	116-120	20

**3 ELASTIC REFLECTIVE BA**

• ЭЛАСТИЧНАЯ СВЕТООТРАЖАЮЩАЯ ПОВЯЗКА • ELASTISCHE REFLEXWARNSTREIFEN



**Kat. II**  
**Cat. II** **CE**

- MATERIAL: PVC
- Reflective film according to EN 13356:2001. High flexibility ensures perfect fit. Soft inner material ensures high comfort of use.
- NORM: EN 13356:2001

Dimensions [cm]	Code	
3 x 34	L9010100	200/1000



CAPS AND TUBE SCARFS MADE OF HIGH VISIBILITY FABRIC  
- PAGES 332, 334-335

**4 TROUSERS BELTS**

• РЕМНИ ДЛЯ БРЮК • HOSENGÜRTEL



**130cm**  
**MAX** **50% COTTON**  
**50% POLYESTER** **CE**

- MATERIAL: 50% cotton / 50% polyester
- Strong metal clamp with a quick and easy fastening system. 130 cm long, can be shortened. 3.7 cm wide. Durable material.

Code	Size [cm]	Colour	
L9020100	one size (max. length 130 cm)		50
L9020200	one size (max. length 130 cm)		50

**1 PROTECTIVE COVERALLS**

• КОМБИНЕЗОНЫ ЗАЩИТНЫЕ • SCHUTZOVERALLS

**50**  
g/m<sup>2</sup>
**Kat. I** **CE**  
**Cat. I**

- **MATERIAL:** polypropylene non-woven fabric 50 g/m<sup>2</sup>.
- **Application:** any dirty works, gardening, car repair, preliminary varnishing works, visits to plants, coveralls for visitors, building works, industrial coating, inspections of machines and devices, protection from dust not hazardous to health, protection of work and daily clothes, hobby.
- **Properties/Features:**
  - Rubber cuffs at the sleeves, legs and hood
  - Rubber at the waist, ensuring optimum fit of the coverall to the body

Size	Code	
M	L4150202	50
L	L4150203	50
XL	L4150204	50
2XL	L4150205	50
3XL	L4150206	50

**2 TYVEK® 500 XPERT, CHF5 MODEL COVERALLS**• КОМБИНЕЗОНЫ ЗАЩИТНЫЕ TYVEK® 500 XPERT, МОДЕЛЬ CHF5  
• SCHUTZOVERALLS TYVEK® CLASSIC XPERT, MODEL CHF5
**Anti-chemical**  
**protective clothes**  
 — Category III

EN 1149-5



TYP 5



TYP 6



EN 14126



EN 1073-2

**CE**

- New protection standard for Type 5 and 6 coveralls. Colour: white. Durable but lightweight (coveralls weight < 180 g). Three-part hood with a rubber band, offering optimum fit for the head and face, even when the user moves. Wide gusset in the crotch offers unrestricted movements. Zip with a lock, made from Tyvek®. Large slider, easy to grasp. Flap covering the zip to improve protection. Sleeves which do not fall down even when you raise your hands. Elastic cuffs on sleeves and legs. Glued-in rubber band at the waist. Tyvek® Classic Xpert coveralls are anti-chemical protective clothes, category III, Type 5-B i 6-B. It is a barrier for biological agents (only the textile) to EN 14126, and also protects from radioactive solids to EN 1073-2. Antistatic finish to EN 1149, both sides. Outer sewn seams. Very small infiltration of solids inside the coveralls thanks to the optimised clothes' design. Sample coveralls application areas: chemical industry, vehicle coating, pharmaceutical industry, non-automatic laminate production, e.g. the production of boats or wind turbine components.

TYVEK® is a registered trade mark of DuPont or its subsidiaries.

\* - DuPont pictogram

Typ 5 - Protection from solids

Typ 6 - Protection from sprayed liquid

EN 1149-1:2006 oraz EN 1149-5:2008 - Anti-static, properties provided the

appropriate grounding is ensured, and the relative humidity is above 25%

EN 1073-2:2002 - Protection from radioactive solids

Size	Code	
S	DU001S	100
M	DU001M	100
L	DU001L	100
XL	DU001XL	100
2XL	DU0012XL	100
3XL	DU0013XL	100

PROLINE

LAHTI PRO

MEGA

JUCO

OTHER BRANDS

ERDI

KLINGSPOR

EXPRESS

ACTION CAN

TRYTON

VULCAN

**1 PROSHIELD<sup>®</sup> BASIC, CHF5 MODEL PROTECTIVE COVERALLS**

- КОМБИНЕЗОНЫ ЗАЩИТНЫЕ PROSHIELD<sup>®</sup> BASIC, МОДЕЛЬ CHF5
- SCHUTZOVERALLS PROSHIELD<sup>®</sup> BASIC, MODELL CHF5



Anti-chemical protective clothes — Category III



EN 1149-5



TYP 5



TYP 6



EN 1073-2



- Limited protection from solids and yet high comfort of work. Fabric: SMS. Coveralls with a hood with a rubber band. Flexible cuffs on the sleeves and legs. Rubber band at the waist (sewn in). A flap covering the zip. Antistatic finish. [EN 1149-5] inside. Protection from radioactive contamination [EN1073-2 Class 1]. Designed to protect from dirt during light works, e.g. in workshops and other industries.

\* - DuPont pictogram

Typ 5 - Protection from solids

Typ 6 - Protection from sprayed liquid

EN 1149-5:2008 - Anti-static. properties provided the appropriate grounding is ensured. and the relative humidity is above 25%

EN 1073-2:2002 - Protection from. radioactive solids

Size	Code	
S	DU012S	50
M	DU012M	50
L	DU012L	50
XL	DU012XL	50
2XL	DU0122XL	50
3XL	DU0123XL	50

**2 PROTECTIVE COVERALLS**

- КОМБИНЕЗОНЫ ЗАЩИТНЫЕ
- SCHUTZOVERALLS

60 g/m<sup>2</sup>



Kat. III  
Cat. III

- **MATERIAL:** multilayer non-woven fabric (polypropylene/polyethylene/polypropylene) 60 g/m<sup>2</sup>
- **Application:** removal of impurities (e.g. asbestos), decontamination work, work with solid and liquid dangerous substances (not under pressure), maintenance, maintenance and repair of industrial lines, inspections of machines and equipment, visiting facilities, construction works, performing industrial coatings, cleaning ducts, work in agriculture and the food industry
- **Features/properties:** - elastic in the waist for optimal coverall fit - cuffs on sleeves, legs and hood - relaxed cut with reinforcement in the crotch - ergonomic, three-part hood - zipper cover extending to the chin - internal overlock seams (green) assuring greater tightness - thumb loops

Size	Code	
L	46194	50
XL	46195	50
2XL	46196	50
3XL	46197	50

**3 PROTECTIVE COVERALLS**

- КОМБИНЕЗОНЫ ЗАЩИТНЫЕ
- SCHUTZOVERALLS



Kat. I  
Cat. I

- **MATERIAL:** polypropylene non-woven fabric 50 g/m<sup>2</sup>
- **Use:** dirty work, gardening, car repairs, preliminary work in varnishing, visiting industrial work areas, coveralls for guests, construction work, applying industrial coatings, inspections of machinery and equipment, protection against non-hazardous dust, protection of work and everyday clothing, hobby.
- **Features/properties:** - cuffs on sleeves, legs and hood - ergonomic, three-part hood - elastic in the waist for optimal coverall fit - zipper cover extending to the chin - external overlock seams assuring greater tightness - relaxed cut with reinforcement in the crotch

Size	Code	
M	46188	100
L	46189	100
XL	46190	100
2XL	46191	100
3XL	46192	100

# HEAD AND HEARING PROTECTION



- caps
- baclavas
- ear guards
- ear plugs
- helmets
- scarfs

**1 PADDED CAPS WITH FLAPS**

• ШАПКИ-УШАНКИ УТЕПЛЁННЫЕ • OHRENMÜTZEN GEFÜTTERT

**215**  
g/m<sup>2</sup>  
COATING

**100**  
g/m<sup>2</sup>  
PADDING

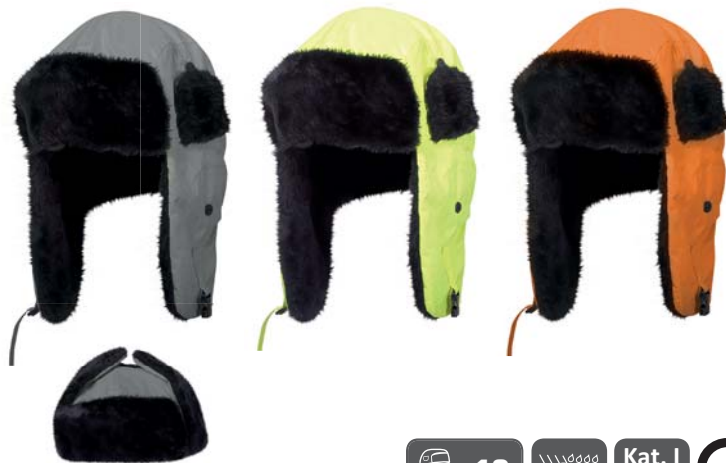

- Coating: 100% polyester; 215 g/m<sup>2</sup>. Lining: 100% polyester; 120 g/m<sup>2</sup>. Padding: faux sheepskin 800 g/m<sup>2</sup>. Filling: 100% polyester; 100 g/m<sup>2</sup>. Waterproofed. PVC-coated textile.
- Flaps fastened up with a buckle. Cap padding with high-quality faux sheepskin. Extra ear protection adjustable with a button.
- NORM: EN ISO 13688

Size (head perimeter) [cm]	Code	Colour	Box
one size (57-61)	L1020100	Grey	8
one size (57-61)	L1020200	Yellow	8
one size (57-61)	L1020300	Orange	8

**2 PADDED CAP WITH FLAPS**

• ШАПКА-УШАНКА УТЕПЛЁННАЯ • OHRENMÜTZE GEFÜTTERT

**175**  
g/m<sup>2</sup>  
COATING

**120**  
g/m<sup>2</sup>  
PADDING

**100%**  
COTTON



- MATERIAL: Coating: 100% cotton, 175 g/m<sup>2</sup>. Lining: 100% polyester; 120 g/m<sup>2</sup>. Padding: faux sheepskin 800 g/m<sup>2</sup>. Filling: 100% polyester; 120 g/m<sup>2</sup>.
- Double layer construction ensures good thermal insulation from cold.
- NORM: EN ISO 13688

Size (head perimeter) [cm]	Code	Colour	Box
60	L1915160	Dark Blue	8

**3 ACRYLIC CAP WITH PADDING**

• ШАПКА АКРИЛОВАЯ УТЕПЛЁННАЯ  
• ACRYLMÜTZEN MIT FÜTTERUNG

**420**  
g/m<sup>2</sup>



Kat. I  
Cat. I

- MATERIAL: Coating: 100% acrylic. Padding: 160 g/m<sup>2</sup>.
- Two-layer padding inside ensures very good thermal insulation from cold.

Size (head perimeter) [cm]	Code	Colour	Box
one size (57-61)	L102060S	Black	12/96

**4 ACRYLIC CAPS WITH PADDING**

• ШАПКИ АКРИЛОВЫЕ УТЕПЛЁННЫЕ  
• ACRYLMÜTZEN MIT FÜTTERUNG

**320**  
g/m<sup>2</sup>



- MATERIAL: Coating: 100% acrylic. Padding: 160 g/m<sup>2</sup>.
- Two-layer padding inside ensures very good thermal insulation from cold. Length adjustment thanks to folding out.
- NORM: EN ISO 13688

Size (head perimeter) [cm]	Code	Colour	Box
one size (57-61)	L1934100	Grey	8
one size (57-61)	L1937100	Yellow	8
one size (57-61)	L1938100	Orange	8

**5 ACRYLIC CAP**

• ШАПКА АКРИЛОВАЯ • ACRYLMÜTZE

**320**  
g/m<sup>2</sup>



- MATERIAL: 100% acrylic
- Adjustable length thanks to folding out. Two-layer structure ensures good thermal insulation.
- NORM: EN ISO 13688

Size (head perimeter) [cm]	Code	Colour	Box
one size (57-61)	L1922100	Black	8

**1 ACRYLIC BALACLAVA**

• БАЛАКЛАВА АКРИЛОВАЯ • ACRYLSTURMHAUBE

**280**  
g/m<sup>2</sup>



x12 **Kat. I**  
**Cat. I**

- MATERIAL: 100% acrylic.
- Balaclava with two holes. Two-layer structure ensures good thermal insulation.
- NORM: EN ISO 13688

Size (head perimeter) (cm)	Code	Colour	
one size (57-61)	L1020500		8

**2 ACRYLIC BALACLAVA**

• БАЛАКЛАВА АКРИЛОВАЯ • ACRYLIC BALACLAVA

**340**  
g/m<sup>2</sup>



x12 **Kat. I**  
**Cat. I**

- MATERIAL: 100% acrylic.
- Balaclava with one hole. Two-layer structure ensures good thermal insulation.
- NORM: EN ISO 13688

Size (head perimeter) (cm)	Code	Colour	
one size (57-61)	L1020400		8



PROLINE

LAHTI PRO

MEGA

JUCCO

OTHER BRANDS

ENDI

KLINGSPOR

EXPRESS

ACTION CAN

TRITON

VULCAN

**1 BASEBALL CAP**

• ШАПКА С КОЗЫРЬКОМ • SCHIRMMÜTZEN

**260**  
g/m<sup>2</sup>

**100%**  
COTTON



- MATERIAL: 100% cotton 260 g/m<sup>2</sup>.
- Adjustable with a metal buckle. Reflective components. Metal-finished ventilation openings to improve air circulation. Stiffened peak and cap front ensure unchanging appearance for long usable life.
- NORM: EN ISO 13688

Size (head perimeter) (cm)	Code	Colour	
one size (57-61)	L1010300		8



**2 BASEBALL CAPS**

• ШАПКИ С КОЗЫРЬКОМ • SCHIRMMÜTZEN

**290**  
g/m<sup>2</sup>

**100%**  
COTTON



- MATERIAL: 100% cotton 290 g/m<sup>2</sup>.
- Velcro adjustment. Ventilation openings to improve air circulation. Stiffened peak and cap front ensure unchanging appearance for long usable life.
- NORM: EN ISO 13688

Size (head perimeter) (cm)	Code	Colour	
one size (57-61)	L1811300		8
one size (57-61)	L1812300		8
one size (57-61)	L1813300		8
one size (57-61)	L1814300		8
one size (57-61)	L1815300		8
one size (57-61)	L1816300		8

**3 BASEBALL CAPS**

• ШАПКИ С КОЗЫРЬКОМ • SCHIRMMÜTZEN

**290**  
g/m<sup>2</sup>



- MATERIAL: 60% cotton, 40% polyester, density 290 g/m<sup>2</sup>.
- Velcro adjustment. Reflective components. Ventilation openings to improve air circulation. Stiffened peak and cap front ensure unchanged appearance for long usable life.
- NORM: EN ISO 13688

Size (head perimeter) (cm)	Code	Colour	
one size (57-61)	L1010100		8
one size (57-61)	L1010200		8



**1 ALL-PURPOSE TUBE SCARVES**

• ПЛАТКИ МНОГОФУНКЦИОНАЛЬНЫЕ • MULTIFUNKTIONSTÜSCHER

**128 g/m<sup>2</sup>**



- MATERIAL: 100% microfibre polyester, breathable, 128 g/m<sup>2</sup>.
- Seamless structure. Reflective stripes improve safety of use. Flexibility. Protection from wind, sunshine, sand, cold or dust. Perfect for active people, doing summer and winter sports or working outdoors.

Size	Code	Colour		
one size	L1030100		x	50/200
one size	L1030200		x	50/200
one size	L1030300		x	50/200

**2 ALL-PURPOSE TUBE SCARVES WITH FLEECE**

• ПЛАТКИ МНОГОФУНКЦИОНАЛЬНЫЕ С ФЛИСОМ • MULTIFUNKTIONSTÜSCHER MIT FLEECE

**220 g/m<sup>2</sup> FLEECE**

**128 g/m<sup>2</sup> MICROFIBRE**



- MATERIAL: 100% polyester mikrofibre/ fleece, breathable, 128 g/m<sup>2</sup> (mikrofibre), 220 g/m<sup>2</sup> (fleece).
- Reflective stripes improve safety of use. Seamless structure of the microfibre part. Flexibility. Excellent protection from frost, cold, wind or dust. Perfect for active people, doing summer and winter sports or working outdoors.

Size	Code	Colour	
one size	L1030400		50/200
one size	L1030600		50/200

**3 ALL-PURPOSE FLEECE TUBE SCARF**

• СНУД (ШАРФ-ТРУБА) МНОГОФУНКЦИОНАЛЬНЫЙ ФЛИСОВЫЙ • MULTIFUNKTIONSSCHLAUCHSCHAL AUS FLEECE

**160 g/m<sup>2</sup>**

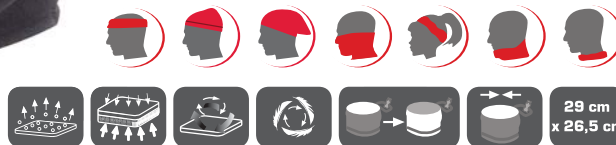

- MATERIAL: Fabric: high-quality fleece 100% polyester, 160 g/m<sup>2</sup>, short-pile, brushed bilaterally and anti-piling.
- Two-layer design provides very good insulation from cold and the ability to use on two sides. Width adjustment with a special drawstring ensures perfect fit and user comfort. Excellent protection from frost, cold, wind or dust. Perfect for active people, doing summer and winter sports or working outdoors.

Size	Code	Colour	
one size	L1030700		50/200

**1 INDUSTRIAL HELMET FOR WORK AT HEIGHT**

- ПРОМЫШЛЕННЫЙ ЗАЩИТНЫЙ ШЛЕМ ДЛЯ РАБОТЫ НА ВЫСОТЕ
- INDUSTRIEHELM FÜR HÖHENARBEITEN



Kat. III  
Cat. III

- MATERIAL: ABS
- Protects from mechanical injuries and low voltage up to 1000 V A.C. or 1500 V D.C. Suitable for use in temperatures ranging from -30°C to +50°C. Practical 3-point chin strap. A short peak ensures excellent visibility. Size adjusted with a knob. Six-strap head structure ensures stable fitting of the helmet on the head.
- NORM: EN 397, EN 50365 Grade 0

Size (cm)	Code	Colour	
52-63	L1040402		20

**2 INDUSTRIAL HELMETS**

- ШЛЕМЫ ПРОМЫШЛЕННЫЕ
- INDUSTRIEHELME



Face shields suitable for protective helmet LAHTI PRO - see page 347



Noise-protection earmuffs suitable for protective helmet LAHTI PRO - see page 338



Kat. II  
Cat. II



- SHELL MATERIAL: ABS
- Protects against mechanical injuries. Suitable for use in temperatures ranging from -10 °C to +50 °C. Functional four-point chinstrap. Vents in the upper part of the shell assure optimum airflow. Size adjustment by means of a knob. Six-arm suspension guarantees stable fitting of the helmet on the head. Universal openings on the sides for mounting accessories. For use with LAHTI PRO ear protectors with the SKU: L1700200 and face shields: L1520400, L1520500
- NORM: EN 397

Size (cm)	Code	Colour	
52-64	L1040501		24
	L1040502		24
	L1040503		24
	L1040504		24
	L1040505		24
	L1040506		24

PROLINE  
LAHTI PRO  
MEGA  
JUCO  
OTHER BRANDS  
ERDI  
KLINGSPOR  
EXPRESS  
ACTION CAN  
TRYTON  
VULCAN

**1 INDUSTRIAL HELMETS**

• ШЛЕМЫ ПРОМЫШЛЕННЫЕ • INDUSTRIESCHUTZHELME

CERTYFIKAT  
**CIOP – PIB**



Kat. III  
Cat. III

- MATERIAL: HDPE
- Protect from mechanical injuries and short-term contact with electric conductors with the current value up to 440 V [Cat. III]. Suitable for use in temperatures ranging from -20°C to +50°C. The harness has four bearing straps made from textile tapes and a main strap in the form of polyethylene pressure moulding. They have a non-woven sweatband and chin strap from textile tape. Groove protecting from dripping water. Universal openings on the sides. Application: building works, industry.
- NORM: EN 397

Size (cm)	Code	Colour	☐
53-59	L1040201	White	20
	L1040202	Red	20
	L1040203	Blue	20
	L1040204	Orange	20
	L1040205	Yellow	20
	L1040206	Green	20

**2 INDUSTRIAL HELMETS**

• ШЛЕМЫ ПРОМЫШЛЕННЫЕ • INDUSTRIESCHUTZHELME



Face shields suitable for protective helmet LAHTI PRO - see page 347

Noise-protection earmuffs suitable for protective helmet LAHTI PRO - see page 338

Kat. II  
Cat. II

- MATERIAL: HDPE
- Protect from mechanical injuries. Suitable for use in temperatures from -10°C to +50°C. Practical chin strap. Six-band harness ensures stable helmet placement on the head. Groove protecting from dripping water. Universal openings on the sides to attach accessories. Application: building works, industry. Compatible with noise-protection earmuffs LAHTI PRO, code: L1700200.
- NORM: EN 397

Size (cm)	Code	Colour	☐
53-64	L1040101	Blue	40
	L1040102	Yellow	40
	L1040103	Orange	40
	L1040104	Green	40
	L1040105	White	40
	L1040106	Red	40



### 1 NOISE-PROTECTION EARMUFFS ATTACHED TO THE INDUSTRIAL PROTECTIVE LAHTI PRO HELMET

- НАУШНИКИ ПРОТИВОШУМНЫЕ ДЛЯ ПРОМЫШЛЕННОГО ЗАЩИТНОГО ШЛЕМА
- GEHÖRSCHUTZ FÜR DIE BEFESTIGUNG AM INDUSTRIESCHUTZHELM LAHTI PRO

**SNR: 26dB**



L10401, L10405

- MATERIAL: ABS
- Sound insulation: SNR: 26dB, H: 27dB, M: 26dB, L: 18dB. Thick and soft earmuff cushions ensure comfort during long-term use. Smooth earmuff height adjustment guarantees perfect fit. Deflecting and rotary earpieces enable work without earmuffs installed, without the need to detach them from the helmet. Compatible with industrial LAHTI PRO helmets, codes: L10401, L10405.
- NORM: EN 352-3

**Kat. III**  
**Cat. III**

Code



L1700200

x

10/60

### 4 FOAM EAR PLUGS

- БЕРУШИ ПЕННЫЕ - GEHÖRSCHUTZSTÖPSEL AUS SCHAUMSTOFF

**SNR: 34dB**



L171010K (5 pairs)



L171010B (100 pairs) L171010D (200 pairs)

7-12 mm

**Kat. III**  
**Cat. III**



- MATERIAL: Made from slow-expandable, soft and elastic polyurethane foam.
- Sound insulation: SNR: 34dB, H: 34dB, M: 31dB, L: 29dB. Hearing protection from excessive noise: excellent insulation of high-frequency sounds. Perfect fit in the hearing duct thanks to the self-forming material. Even pressure distribution on the hearing duct, ensuring high comfort of use. Smooth and dirt-proof surface, preventing accumulation of dirt. Disposable product.
- NORM: EN 352-2

Code

Quantity per package

Package



L171010K	5 pairs	blister	40/800
L171010B	100 pairs	box	20
L171010D	200 pairs	dispenser	20

### 2 NOISE-PROTECTION EARMUFFS

- НАУШНИКИ ПРОТИВОШУМНЫЕ
- GEHÖRSCHUTZ

**SNR: 29dB**



**Kat. III**  
**Cat. III**

- MATERIAL: ABS
- Sound insulation: SNR: 29dB, H: 32dB, M: 27dB, L: 19dB. Smooth earmuff height adjustment guarantees perfect fit to the head. Thick and soft earmuff cushions ensure comfort during long-term use.
- NORM: EN 352-1

Code



46032

x

10/60

### 5 FOAM EAR PLUGS

- БЕРУШИ ПЕННЫЕ - GEHÖRSCHUTZSTÖPSEL AUS SCHAUMSTOFF



**SNR: 36dB**

**Kat. II**  
**Cat. II**



- MATERIAL: Polyurethane foam
- Sound insulation: SNR: 36dB, H: 34dB, M: 34dB, L: 31dB. Thanks to the self-forming polyurethane foam, the ear plug evenly distributes pressure on the hearing duct. Elastic. Very good protection from excessive noise. Application: food industry. Sold in plastic bags - 10 pairs in a package.
- NORM: EN 352-2

Code

Dimensions (mm)



46002

11 x 25

10

### 6 SILICONE EAR PLUGS

- БЕРУШИ СИЛИКОНОВЫЕ - GEHÖRSCHUTZSTÖPSEL AUS SILIKON

**SNR: 32dB**



8-10 mm

**Kat. III**  
**Cat. III**



- MATERIAL: Soft and flexible silicagel.
- Sound insulation: SNR: 32dB, H: 32dB, M: 29dB, L: 28dB. Protection from excess noise; perfect insulation of high-frequency sounds. Special ring shape enables easy fitting in the hearing duct. Smooth and dirt-proof surface preventing accumulation of dirt. Disposable product.
- NORM: EN 352-2

Code

Quantity per package



L171020K

5 pairs

x

40/800

### 7 BOW-MOUNTED EAR PLUGS

- БЕРУШИ НА ДУЖКЕ
- BÜGELGEHÖRSCHUTZSTÖPSEL AUS SCHAUMSTOFF

**SNR: 21dB**



**Kat. III**  
**Cat. III**



- MATERIAL: Tips: thermoplastic elastomer. Bow: ABS.
- Sound insulation: SNR: 21dB, H: 22dB, M: 17dB, L: 15dB. Hearing protection from excessive noise; very good insulation of high-frequency sounds. Comfortable bow which ensures easy plug manipulation. Smooth and dirt-proof surface preventing accumulation of dirt. Lightweight and comfortable alternative to earmuffs. Reusable product.
- NORM: EN 352-2

Code



L1710300

x

15/300

# EYE AND FACE PROTECTION

- face shields
- glasses
- goggles
- welding helmets



**1 TRANSPARENT PROTECTIVE GLASSES**

• ЗАЩИТНЫЕ ОЧКИ БЕСЦВЕТНЫЕ • SCHUTZBRILLE KLAR

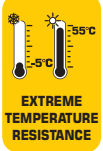

- MATERIAL: Transparent polycarbonate lenses with UV filter, covered with a special coating preventing fogging, resistant to scratching.
- Their inside is finished with EVA foam (dismountable) which seals, absorbs shock and improves the comfort of use. Designed for personal eye protection against mechanical damage. Protect from impact with particles weighing 0.86 g at 45 m/s in extreme temperatures (guaranteed resistance from -5°C ± 2°C to 55°C ± 2°C). Resistance grade - FT.
- NORM: EN 166, EN 170

Code		
L1500500	x	48

**2 TRANSPARENT PROTECTIVE GLASSES**

• ЗАЩИТНЫЕ ОЧКИ БЕСЦВЕТНЫЕ  
• SCHUTZBRILLE KLAR

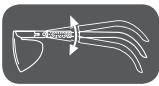
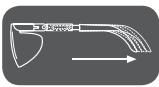

- MATERIAL: Transparent polycarbonate lenses.
- Earpiece length and angle adjustment. Adjustment of earpiece length. Soft nosepiece reducing the risk of irritation. Wide field of vision. Lightweight and robust structure. Designed for personal eye protection against mechanical damage. Protect from impact with particles weighing 0.86 g at 45 m/s. Resistance class - F.
- NORM: EN 166

Code		
46037	x	48

**3 GREY PROTECTIVE GLASSES**

• ЗАЩИТНЫЕ ОЧКИ СЕРЫЕ • SCHUTZBRILLE GRAU

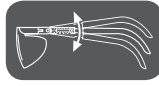
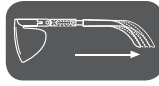

- MATERIAL: Grey polycarbonate lenses with glare protection.
- Earpiece length and angle adjustment. Soft nosepiece reducing the risk of irritation. Wide field of vision. Lightweight and strong structure. Designed for personal eye protection against mechanical damage. Protect from impact with particles weighing 0.86 g at 45 m/s. Resistance class - F.
- NORM: EN 166, EN 172

Code		
46038	x	48

**4 YELLOW PROTECTIVE GLASSES**

• ЗАЩИТНЫЕ ОЧКИ ЖЁЛТЫЕ • SCHUTZBRILLE GELB

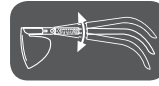
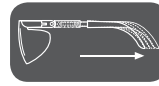

- MATERIAL: Yellow polycarbonate lenses with UV filter.
- Earpiece length and angle adjustment. Openings on the earpiece ends to attach a string/suspension. A soft nosepiece to reduce the risk of irritation. Wide field of vision. Lightweight and strong structure. Designed for personal eye protection against mechanical damage. Protect from impact with particles weighing 0.86 g at 45 m/s. Resistance class - F.
- NORM: EN 166, EN 172

Code		
46039	x	48

**1 TRANSPARENT PROTECTIVE GLASSES**

• ЗАЩИТНЫЕ ОЧКИ БЕСЦВЕТНЫЕ • SCHUTZBRILLE KLAR



**FT** MECHANICAL RESISTANCE  
**UV** EXTREME TEMPERATURE RESISTANCE  
 Kat. II  
 Cat. II

- MATERIAL: Transparent polycarbonate lenses with UV filter. Comfortable, flexible earpieces made from TPR.
- Openings on the earpiece ends, enabling to attach a string/suspension. Soft nosepiece reducing the risk of irritation. Lightweight and strong structure. Designed for personal eye protection against mechanical damage. Protect from impact with particles weighing 0.86 g at 45 m/s in extreme temperatures (guaranteed protection from -5°C ± 2°C to 55°C ± 2°C ) Resistance class - FT.
- NORM: EN 166, EN 170

Code		
L1500200	x	12/300

**2 GREY PROTECTIVE GLASSES**

• ЗАЩИТНЫЕ ОЧКИ СЕРЫЕ • SCHUTZBRILLE GRAU



**FT** MECHANICAL RESISTANCE  
**SPF** SUN PROTECTIVE FACTOR  
 Kat. II  
 Cat. II

- MATERIAL: Grey polycarbonate lenses with glare protection. Comfortable, flexible earpieces made from TPR.
- Openings on the earpiece ends, enabling to attach a string/suspension. Soft nosepiece reducing the risk of irritation. Lightweight and strong structure. Designed for personal eye protection against mechanical damage. Protect from impact with particles weighing 0.86 g at 45 m/s in extreme temperatures (guaranteed protection from -5°C ± 2°C to 55°C ± 2°C ). Resistance class - FT.
- NORM: EN 166, EN 172

Code		
L1500300	x	12/300

**3 YELLOW PROTECTIVE GLASSES**

• ЗАЩИТНЫЕ ОЧКИ ЖЕЛТЫЕ • SCHUTZBRILLE GELB



**FT** MECHANICAL RESISTANCE  
**UV** EXTREME TEMPERATURE RESISTANCE  
 Kat. II  
 Cat. II

- MATERIAL: Yellow polycarbonate lenses with UV filter . Comfortable, flexible earpieces made from TPR.
- Openings on the earpiece ends, enabling to attach a string/suspension. Soft nosepiece reducing the risk of irritation. Lightweight and robust structure. Designed for personal eye protection against mechanical damage. Protect from impact with particles weighing 0.86 g at 45 m/s in extreme temperatures (guaranteed protection from -5°C ± 2°C to 55°C ± 2°C ). Resistance class - FT.
- NORM: EN 166, EN 170

Code		
L1500400	x	12/300

**4 TRANSPARENT PROTECTIVE GLASSES**

• ЗАЩИТНЫЕ ОЧКИ БЕСЦВЕТНЫЕ • SCHUTZBRILLE KLAR



**F** MECHANICAL RESISTANCE  
 Kat. II  
 Cat. II

- MATERIAL: Transparent polycarbonate lenses.
- Adjustment of earpiece length. Soft nosepiece reducing the risk of irritation. Lightweight and robust structure. Designed for personal eye protection against mechanical damage. Protect from impact with particles weighing 0.86 g at 45 m/s. Resistance class - F.
- NORM: EN 166

Code		
46033	x	12/300

**5 GREY PROTECTIVE GLASSES**

• ЗАЩИТНЫЕ ОЧКИ СЕРЫЕ • SCHUTZBRILLE GRAU



**F** MECHANICAL RESISTANCE  
**SPF** SUN PROTECTIVE FACTOR  
 Kat. II  
 Cat. II

- MATERIAL: Grey polycarbonate lenses with glare protection.
- Adjustment of earpiece length. Soft nosepiece reducing the risk of irritation. Lightweight and strong structure. Designed for personal eye protection against mechanical damage. Protect from impact with particles weighing 0.86 g at 45 m/s. Resistance class - F.
- NORM: EN 166, EN 172

Code		
46035	x	12/300

**6 YELLOW PROTECTIVE GLASSES**

• ЗАЩИТНЫЕ ОЧКИ ЖЕЛТЫЕ • SCHUTZBRILLE GELB



**F** MECHANICAL RESISTANCE  
**UV**  
 Kat. II  
 Cat. II

- MATERIAL: Yellow polycarbonate lenses with UV filter.
- Earpiece length and angle adjustment. Openings on the earpiece ends to attach a string/suspension. A soft nosepiece to reduce the risk of irritation. Lightweight and strong structure. Designed for personal eye protection against mechanical damage. Protect from impact with particles weighing 0.86 g at 45 m/s. Resistance class - F.
- NORM: EN 166, EN 170

Code		
46051	x	12/300

PROLINE

LAHTI PRO

MEGA

JUCCO

OTHER BRANDS

ERDI

KLINGSPOR

EXPRESS

ACTION CAN

TRYTON

VULCAN

**1 TRANSPARENT PROTECTIVE GLASSES**

• ЗАЩИТНЫЕ ОЧКИ БЕСЦВЕТНЫЕ • SCHUTZBRILLE KLAR



**F**  
MECHANICAL RESISTANCE

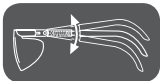
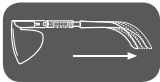

Kat. II  
Cat. II **CE**

- MATERIAL: Transparent polycarbonate lenses.
- Adjustable earpieces (angle and length adjustment). Designed for personal eye protection against mechanical damage. Protect from impact with particles weighing 0.86 g at 45 m/s. Resistance class - F.
- NORM: EN 166

Code		
L2011300	x	12/300

**2 TRANSPARENT PROTECTIVE GLASSES**

• ЗАЩИТНЫЕ ОЧКИ БЕСЦВЕТНЫЕ • SCHUTZBRILLE KLAR



**F**  
MECHANICAL RESISTANCE

Kat. II  
Cat. II **CE**

- MATERIAL: Transparent polycarbonate lenses.
- Designed for personal eye protection against mechanical damage. Protect from impact with particles weighing 0.86 g at 45 m/s. Resistance class - F.
- NORM: EN 166

Code		
46018	x	12/300

**3 TRANSPARENT PROTECTIVE GLASSES**

• ЗАЩИТНЫЕ ОЧКИ БЕСЦВЕТНЫЕ • SCHUTZBRILLE KLAR



**F**  
MECHANICAL RESISTANCE

Kat. II  
Cat. II **CE**

- MATERIAL: Transparent polycarbonate lenses.
- Designed for personal eye protection in the hazard of splinters and splashes created when grinding, drilling, cutting, mowing, chiselling, coating etc.. Protect from impact with particles weighing 0.86 g at 45 m/s. Resistance class - F.
- NORM: EN 166

Code		
46023	x	10/100

**4 TRANSPARENT PROTECTIVE GLASSES**

• ЗАЩИТНЫЕ ОЧКИ БЕСЦВЕТНЫЕ • SCHUTZBRILLE KLAR



**S**  
MECHANICAL RESISTANCE

Kat. II  
Cat. II **CE**

- MATERIAL: Transparent polycarbonate lenses.
- Designed for personal eye protection in the hazard of splinters and splashes created when grinding, drilling, cutting, mowing, chiselling etc.. Protect from impact with particles weighing 43 g at 5.1 m/s. Resistance class - S.
- NORM: EN 166

Code		
L1500100	x	12/240

**5 MESH PROTECTIVE GLASSES**

• ЗАЩИТНЫЕ ОЧКИ СЕТЧАТЫЕ • SCHUTZBRILLE MIT NETZ



**F**  
MECHANICAL RESISTANCE

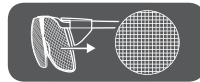

Kat. II  
Cat. II **CE**

- MATERIAL: Metal mesh/plastic.
- No steaming effect thanks to lenses replaced with metal mesh. Special shape of earpieces, offering additional side protection and not reducing the field of vision. Openings on the earpiece ends to attach a string/suspension. Lightweight and strong structure ensuring high comfort of use. Designed for personal eye protection against mechanical damage resulting from solids. Protect from impact with particles weighing 0.86 g at 45 m/s. Application: gardening works, i.e. shrub trimming, lawn mowing etc., tree felling, manual and machine treatment of wood, metals, plastic, stone and aggregates. Resistance class - F.
- NORM: EN 1731

Code		
LPOS01	x	12/300

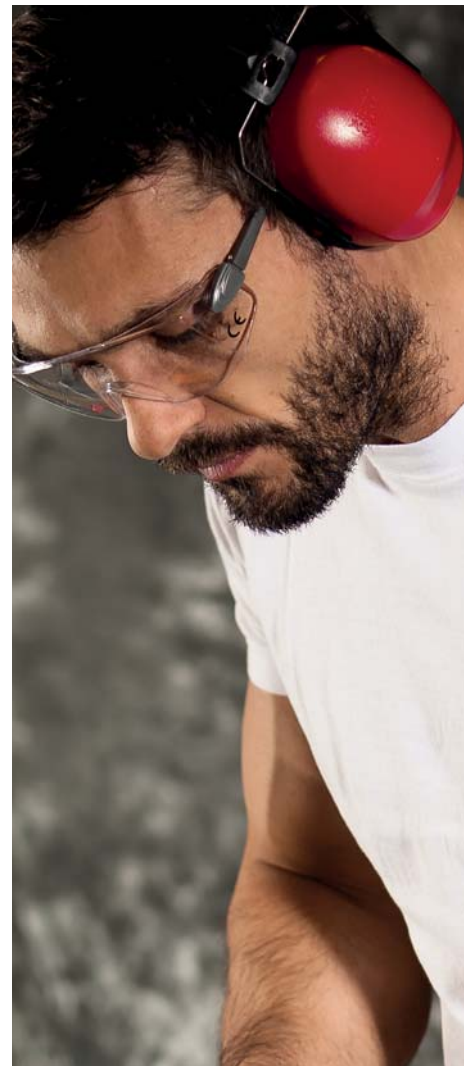



**1 PROTECTIVE GOGGLES**

• ЗАЩИТНЫЕ ОЧКИ „ГУГЛЫ“ ПРОТИВООСКОЛОЧНЫЕ • SPLITTERSCHUTZGOOGLES

**BT**  
MECHANICAL  
RESISTANCE**UV****ANTI-FOG****EXTREME  
TEMPERATURE  
RESISTANCE****Kat. II  
Cat. II** **CE**

- MATERIAL: Transparent polycarbonate glass with UV filter with anti-fog coating.
- Protect from splinters and splashes created when grinding, drilling, cutting, mowing, chiselling etc. Wide, adjustable flexible rubber band, ensuring perfect fit. Ventilation openings to ensure excellent air circulation. Designed for personal eye protection against mechanical damage. Protect from impact with particles weighing 0.86 g at 120 m/s in extreme temperatures (guaranteed protection from -5°C ± 2°C to 55°C ± 2°C). Resistance class - BT.
- NORM: EN 166, EN 170

Code

**L1510500**

x

5/100

**2 PROTECTIVE GOGGLES**

• ЗАЩИТНЫЕ ОЧКИ „ГУГЛЫ“ ПРОТИВООСКОЛОЧНЫЕ • SPLITTERSCHUTZGOOGLES

**B**  
MECHANICAL  
RESISTANCE**Kat. II  
Cat. II** **CE**

- MATERIAL: The transparent polycarbonate glass.
- The transparent polycarbonate pane offers eye protection against splinters and splashes created when grinding, drilling, cutting, mowing, chiselling etc. Wide, adjustable flexible rubber band, ensuring perfect fit. Ventilation openings ensure perfect circulation of air. Designed for personal eye protection against mechanical damage. Protect from impact with particles weighing 0.86 g at 120 m/s. Resistance class - B.
- NORM: EN 166

Code

**L1510400**

x

10/60

**3 PROTECTIVE GOGGLES**

• ЗАЩИТНЫЕ ОЧКИ „ГУГЛЫ“ ПРОТИВООСКОЛОЧНЫЕ • SPLITTERSCHUTZGOOGLES

**F**  
MECHANICAL  
RESISTANCE**Kat. II  
Cat. II** **CE**

- MATERIAL: Transparent polycarbonate glass.
- Adjustable elastic rubber band, ensuring perfect fit. Cut-out openings preventing glass fogging. Designed for personal eye protection against mechanical damage. Protect from impact with particles weighing 0.86 g at 45 m/s. Resistance class - F.
- NORM: EN 166

Code

**46017**

x

20/200

**4 PROTECTIVE GOGGLES**

• ЗАЩИТНЫЕ ОЧКИ „ГУГЛЫ“ ПРОТИВООСКОЛОЧНЫЕ • SPLITTERSCHUTZGOOGLES

**S**  
MECHANICAL  
RESISTANCE**Kat. II  
Cat. II** **CE**

- MATERIAL: The transparent polycarbonate glass.
- Protect against splinters and splashes created when grinding, drilling, cutting, mowing, chiselling etc. Adjustable elastic rubber band, ensuring perfect fit. Cut-out openings preventing glass fogging. Protect from impact with particles weighing 43 g at 5.1 m/s. Resistance class - S.
- NORM: EN 166

Code

**L1510100**

x

20/120

**5 PROTECTIVE GOGGLES**

• ЗАЩИТНЫЕ ОЧКИ „ГУГЛЫ“ ПРОТИВООСКОЛОЧНЫЕ • SPLITTERSCHUTZGOOGLES

**B**  
MECHANICAL  
RESISTANCE**ANTI-FOG****Kat. II  
Cat. II** **CE**

- MATERIAL: Transparent PC glass, resistant to fogging.
- The goggles are well-ventilated which improves the comfort of work. Protect from impact with particles weighing 0.86 g at 120 m/s. Resistance class - B.
- NORM: EN 166

Code

**46028**

10

**1 WELDING GOGGLES**

• Очки „ГУГЛЫ“ ЗАЩИТНЫЕ СВАРОЧНЫЕ • SCHWEISSBRILLE

CERTYFIKAT  
**CIOP - PIB**



- MATERIAL: metal
- Designed to protect the eyes and their vicinity against welding radiation, hot and cold splinters of melted metal, sinter, sun rays, when firing and melting certain metals, seam heating. Resistant to low-energy impact with a ball weighing 0.86 g at 45 m/s. The two glasses are connected with a special connector enabling to adjust them to any face. Not subject to deformation. Resistant to changing weather conditions and corrosion. Tilting frame with a filter, enabling to view without the need to remove the goggles.
- NORM: EN 175

Code	Dimensions (mm)	
L1510200	200 x 100 x 70	8/80

**2 WELDING GOGGLES**

• Очки „ГУГЛЫ“ СВАРОЧНЫЕ • SCHWEISSBRILLE



- MATERIAL: made from plastic.
- Designed to protect eyes and their vicinity against welding radiation and sun rays. Tilting frame with a filter enabling to view without removing the goggles. With a replaceable protection pane and welding filter with dimming rate of 5 DIN. 6 ventilation openings. Weight 90 g.
- NORM: EN 175

Code	Dimensions (mm)	
L1510300	180 x 100 x 90	60

**3 WELDING SHIELDS**

• ЩИТКИ СВАРОЧНЫЕ • SCHWEISSSCHILDE

CERTYFIKAT  
**CIOP - PIB**

L1530100



L1530200



L1530300



L1530400



- MATERIAL: rigid pressboard
- Designed for protecting welder's eyes, face and neck from intense visible light, hazardous ultraviolet and infrared radiation of the electric arc, as well as from the spatter of melt metal and slag during the welding process. The standard accessories include replaceable protective pane and welding filter with the dimming rate of 10 DIN (for the window shield, the window filter has the dimming rate of 5 DIN).
- NORM: EN 175

Code	Filter size (mm)	Filter with preview	Dimensions (mm)	Handle type	
L1530100	50 x 100	no	470 x 290 x 105	wooden	30
L1530200	80 x 100	no	390 x 230 x 85	wooden	40
L1530300	50 x 100	no	390 x 230 x 85	plastic	35
L1530400	50 x 100 + 20 x 100	yes	390 x 230 x 85	wooden	40

**4 WELDING SHIELDS**

• ЩИТКИ СВАРОЧНЫЕ • SCHWEISSCHILDE

CERTYFIKAT  
**CIOP - PIB**

L1530500



L1530600



- MATERIAL: rigid pressboard
- Designed for protecting welder's eyes, face and neck from intense visible light, hazardous ultraviolet and infrared radiation of the electric arc, as well as from the spatter of melt metal and slag during the welding process. Recommended especially for works in places difficult to reach. The standard accessories include replaceable protective pane and welding filter with the dimming rate of 10 DIN. Extra lightweight. Easily replaced filter and protective pane thanks to the plastic frame they are installed in.
- NORM: EN 175

Code	Filter size (mm)	Filter size	Dimensions	Handle type	
L1530500	50 x 100	no	350 x 260 x 85	plastic	40
L1530600	50 x 100	no	275 x 200 x 50	plastic	60

**1 WELDING SHIELD**

• ЩИТОК СВАРОЧНЫЙ • SCHWEISSCHILD

CERTYFIKAT  
**CIOP - PIB**



Kat. II  
Cat. II

- MATERIAL: composite
- Designed for protecting welder's eyes, face and neck from intense visible light, hazardous ultraviolet and infrared radiation of the electric arc, as well as from the spatter of melt metal and slag during the welding process. The standard accessories include replaceable protective pane and welding filter with the dimming rate of 10 DIN. Easily replaced filter and protective pane. Resistant to cracking and moisture. Perfect for working outdoors.
- NORM: EN 175

Code	Filter size (mm)	Filter with preview	Dimensions (mm)	Handle type	
L1530700	50 x 100	nie	420 x 265 x 120	plastic	20

**2 WELDING HELMET**

• ШЛЕМ СВАРОЧНЫЙ • SCHWEISSHELM

CERTYFIKAT  
**CIOP - PIB**



Adjustable head straps

Kat. II  
Cat. II

- MATERIAL: plastic
- Designed for protecting welder's eyes, face and neck from intense visible light, hazardous ultraviolet and infrared radiation of the electric arc, as well as from the spatter of melt metal and slag during the welding process. The standard accessories include replaceable welding filter with the dimming rate of 11 DIN, glass transparent filter and polycarbonate protective pane. Comfortable, adjustable head strap. Tilting frame with a filter enabling to see without the need to raise the visor helmet. Resistant to cracking and moisture. Perfect for working outdoors.
- NORM: EN 175

Code	Filter size (mm)	Helmet size (mm)	
L1540300	90 x 110	320 x 220 x 190	20

**3 WELDING HELMETS**

• ШЛЕМЫ СВАРОЧНЫЕ • SCHWEISSHELME

CERTYFIKAT  
**CIOP - PIB**

L1540100



Adjustable head straps



L1540200

Kat. II  
Cat. II

- MATERIAL: rigid pressboard
- Designed for protecting welder's eyes, face and neck from intense visible light, hazardous ultraviolet and infrared radiation of the electric arc, as well as from the spatter of melt metal and slag during the welding process. The standard accessories include replaceable protective pane and welding filter with the dimming rate of 10 DIN (for the window-equipped version, the window filter has the dimming rate of 5 DIN). Comfortable, adjustable head strap.
- NORM: EN 175

Code	Filter size (mm)	Filter with preview	Helmet size (mm)	Collar (leather)	
L1540100	80 x 100	no	325 x 220 x 175	no	20
L1540200	50 x 100 + 20 x 100	yes	325 x 220 x 175	yes	20

### 1 AUTO DARKENING WELDING HELMET

• ШЛЕМ СВАРОЧНЫЙ САМОЗАТЕМНЯЮЩИЙСЯ - AUTOMATIK SCHWEISSHELM

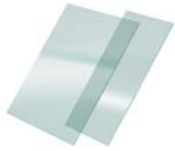

Replaceable glass  
L1540401  
- see page 347

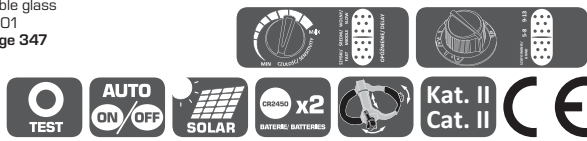

- MATERIAL: polyamide
- Two-range dimming 5-8/9-13 DIN. Permanent protection from UV/IR radiation - 16 DIN. Field of vision size 98 x 55 mm. 4 light sensors. Automatic switching on/off. Filter test. Grinding function. Response time: 1/25000 s. Smooth adjustment of sensitivity and lightening delay. Power supply: solar battery + 2 CR2450 batteries. Adjustable head straps. Replaceable glass L1540401 available.
- NORM: EN 379



Code	Field of vision size (mm)	Helmet size (mm)	
L1540400	98 x 55	241 x 230 x 330	6

### 2 AUTO DARKENING WELDING HELMET

• ШЛЕМ СВАРОЧНЫЙ САМОЗАТЕМНЯЮЩИЙСЯ - AUTOMATIK SCHWEISSHELM

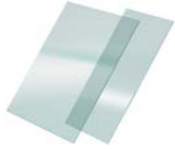

Replaceable glass  
L1540501  
- see page 347



- MATERIAL: polyamide
- Dimming range 9-13 DIN. Permanent protection from UV/IR radiation - 16 DIN. Field of vision size 100 x 50 mm. 2 light sensors. Automatic switching on/off. Filter test. Grinding function. Response time: 1/25000 s. Smooth adjustment of sensitivity and lightening delay. Power supply: solar battery + 2 CR2032 batteries. Adjustable head straps. Replaceable glass L1540501 available.
- NORM: EN 379



Code	Field of vision size (mm)	Helmet size (mm)	
L1540500	100 x 50	241 x 230 x 330	6

### 3 AUTO DARKENING WELDING HELMET

• ШЛЕМ СВАРОЧНЫЙ САМОЗАТЕМНЯЮЩИЙСЯ - AUTOMATIK SCHWEISSHELM

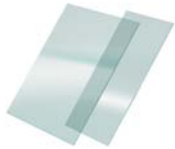

Replaceable glass  
L1540601  
- see page 347



- MATERIAL: polyamide
- Dimming range 9-13 DIN. Permanent protection from UV/IR radiation - 16 DIN. Field of vision size 92 x 42 mm. 2 light sensors. Automatic switching on/off. Grinding function. Response time: 1/15000 s. Smooth adjustment of sensitivity and lightening delay. Power supply: solar battery + 2 non-replaceable CR2032 batteries. Adjustable head straps. Replaceable glass L1540601 available.
- NORM: EN 379



Code	Field of vision size (mm)	Helmet size (mm)	
L1540600	92 x 42	241 x 230 x 330	6

### 1 COVER LENS FOR WELDING HELMET

- НАБОР СМЕННЫХ СТЕКОЛ (ВНУТРЕННИХ И НАРУЖНЫХ) ДЛЯ САМОЗАТЕМНЯЮЩИХСЯ ШЛЕМОВ
- SATZ AUSTAUSCHBARER GLÄSER (INNEN UND AUSSEN) FÜR SELBSTDIMMENDE VISIERE

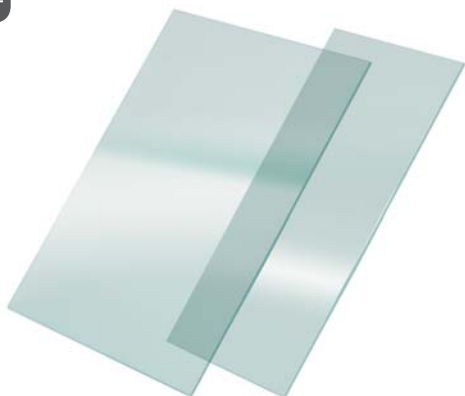

- MATERIAL: polycarbonate
- Resistant to medium energy impact with a ball weighing 0.86 g at a speed of 45 m/s. Resistance class - F. Thickness 0.8 mm. For use as replaceable parts in L1540400, L1540500, L1540600 face masks.
- NORM: EN 166

Code	Helmet type	
L1540401	L1540400	50
L1540501	L1540500	50
L1540601	L1540600	50

### 2 FACE SHIELD ATTACHED TO INDUSTRIAL LAHTI PRO HELMET

- ЗАЩИТНЫЙ ЛИЦЕВОЙ ЩИТОК ДЛЯ КРЕПЛЕНИЯ К ПРОМЫШЛЕННОМУ ЗАЩИТНОМУ ШЛЕМУ LAHTI PRO
- GESICHTSSCHUTZ FÜR DIE BEFESTIGUNG AM INDUSTRIESCHUTZHELM LAHTI PRO



- MATERIAL: polycarbonate
- First optical class. Resistant to solid spatter. Resistant to splashes of non-aggressive liquids created when working (e.g. manual and machine treatment of metal, wood, plastic etc.). Resistant to medium-energy impact with a ball weighing 0.86 g at 120 m/s. Resistance grade - B. Compatible with industrial LAHTI PRO helmets, codes: L10401, L10405 and noise-protection earmuffs L1700200.

Code	Helmet size (mm)	
L1520400	200	25/50

### 3 MESH FACE SHIELD ATTACHED TO INDUSTRIAL LAHTI PRO HELMET

- СЕТЧАТЫЙ ЛИЦЕВОЙ ЩИТОК ДЛЯ КРЕПЛЕНИЯ К ПРОМЫШЛЕННОМУ ЗАЩИТНОМУ ШЛЕМУ LAHTI PRO
- NETZGESICHTSSCHUTZ FÜR DIE BEFESTIGUNG AM INDUSTRIESCHUTZHELM LAHTI PRO



- MATERIAL: metal
- Resistant to solid spatter created when working (e.g. manual and machine treatment of metal, wood, plastic etc.). Resistant to low-energy impact with a ball weighing 0.86 g at 45 m/s. Resistance grade - F. Compatible with industrial LAHTI PRO helmets, codes: L10401, L10405 and noise-protection earmuffs L1700200.

Code	Shield height (mm)	
L1520500	210	25/50



PROLINE

LAHTI PRO

MEGA

JUCO

OTHER BRANDS

ERDI

KLINGSPOR

EXPRESS

ACTION CAN

TRYTON

VULCAN

**1 FACE SHIELD**

• ЗАЩИТНЫЙ ЛИЦЕВОЙ ЩИТОК • GESICHTSSCHUTZ



CERTYFIKAT  
**CIOP - PIB**



Kat. II  
Cat. II

- MATERIAL: polycarbonate
- Spatter protection with a visor and adjustable head straps, made from polycarbonate 1 mm thick. First optical class. Resistant to solid spatter. Resistant to liquid splashes:
  - of acids (sulphuric, hydrochloric, hydrosulphuric, nitric, phosphoric acids)
  - low-concentration alcohols, e.g. 25% ammonia
  - alcohols, except methyl alcohols
  - aliphatic hydrocarbons
  - detergents
  - fuels
  - mineral, animal, vegetable oils
  - engine oils
- Resistance to medium-energy impact with a ball weighing 0.86 g, with the speed of 120 m/s. Weight 245 g. Resistance class - B.
- NORM: EN 166

Code	Pane height [mm]	
L1520300	240	40

**2 FACE SHIELD**

• ЗАЩИТНЫЙ ЛИЦЕВОЙ ЩИТОК • GESICHTSSCHUTZ



CERTYFIKAT  
**CIOP - PIB**



Kat. II  
Cat. II

- MATERIAL: polycarbonate
- Spatter protection with adjustable head straps, made from polycarbonate 1 mm thick. First optical class. Resistance to solid splinters. Resistance to liquid splashes:
  - of acids (sulphuric, hydrochloric, hydrosulphuric, nitric, phosphoric acids)
  - low-concentration alcohols, e.g. 25% ammonia
  - alcohols, except methyl alcohols
  - aliphatic hydrocarbons
  - detergents
  - fuels
  - mineral, animal, vegetable oils
  - engine oils
- Resistance to medium-energy impact with a ball weighing 0.86 g, with the speed of 120 m/s. Weight 215 g. Resistance class - B.
- NORM: EN 166

Code	Pane height [mm]	
L1520200	240	45

**3 FACE SHIELD**

• ЗАЩИТНЫЙ ЛИЦЕВОЙ ЩИТОК • GESICHTSSCHUTZ



CERTYFIKAT  
**CIOP - PIB**



Kat. II  
Cat. II

- MATERIAL: polycarbonate
- Spatter protection with Velcro-adjustable head straps, made from polycarbonate 1 mm thick. First optical class. Resistant to solid spatter. Resistant to liquid splashes:
  - of acids (sulphuric, hydrochloric, hydrosulphuric, nitric, phosphoric acids)
  - low-concentration alcohols, e.g. 25% ammonium hydroxide
  - alcohols, except methyl alcohols
  - aliphatic hydrocarbons
  - detergents
  - fuels
  - mineral, animal, vegetable oils
  - engine oils
- Resistance to medium-energy impact with a ball weighing 0.86 g, with the speed of 120 m/s. Weight 107 g. Resistance class - B.
- NORM: EN 166

Code	Pane height [mm]	
L1520100	200	100

**4 FACE SHIELD**

• ЗАЩИТНЫЙ ЛИЦЕВОЙ ЩИТОК • GESICHTSSCHUTZ



Kat. II  
Cat. II

- MATERIAL: polycarbonate
- Projectile guard with visor and adjustable headband. Made of polycarbonate. Resistant to solid spatter. Resistant to medium energy impact with a ball weighing 0.86 g at a speed of 120 m/s. Resistance class - B.
- NORM: EN 166

Code	Pane height [mm]	
L1520600	200	10/40

**5 MESH FACE SHIELD**

• ЗАЩИТНЫЙ СЕТЧАТЫЙ ЛИЦЕВОЙ ЩИТОК • NETZ-GESICHTSSCHUTZ



Kat. II  
Cat. II

- MATERIAL: metal mesh
- Projectile guard with visor and adjustable headband. Made of metal mesh. Resistant to solid spatter. Resistant to medium energy impact with a ball weighing 0.86 g at a speed of 45 m/s. Resistance class - F.
- NORM: EN 166

Code	Pane height [mm]	
L1520700	180	10/40

# RESPIRATORY PROTECTION

absorbers  
half-masks  
masks



PROLINE

LAHTI PRO

MEGA

JUCO

OTHER BRANDS

ERDI

KLINGSPOR

EXPRESS

ACTION CAN

TRAYTON

VULCAN

**1 FFP1 DUST-PROOF MASKS**

• РЕСПИРАТОРЫ ПРОТИВОПЫЛЬНЫЕ FFP1 • STAUBMASKEN FFP1

**FFP1**



**Kat. III**  
**Cat. III**

- MATERIAL: Multi-layered filtration material.
- Designed for work in conditions where the dispersed phase concentration does not exceed 4 x TLV. Multi-layered filtration material protects the respiratory system. Nose clip and polyurethane foam seal guarantee comfortable use. The headband made from braided rubber threads ensures perfect fit of the mask to the face.
- NORM: EN 149

Code	Quantity per package		
L1200100	5	x	100

**2 FFP1 DUST-PROOF MASKS WITH A VALVE**

• РЕСПИРАТОРЫ ПРОТИВОПЫЛЬНЫЕ FFP1 С КЛАПАНОМ  
• STAUBMASKEN FFP1 MIT VENTIL

**FFP1**



**Kat. III**  
**Cat. III**

- MATERIAL: Multi-layered filtration material.
- Designed for work in conditions where the dispersed phase concentration does not exceed 4 x TLV. Multi-layered filtration material protects the respiratory system. Nose clip and polyurethane foam seal guarantee comfortable use. The valve facilitates air exhalation. The headband made from braided rubber threads ensures perfect fit of the mask to the face.
- NORM: EN 149

Code	Quantity per package		
L1200200	3	x	100

**5 FFP2 DUST-PROOF MASKS**

• РЕСПИРАТОРЫ ПРОТИВОПЫЛЬНЫЕ FFP2  
• STAUBMASKEN FFP2

**FFP2**



**Kat. III**  
**Cat. III**

- MATERIAL: Multi-layered filtration material.
- Designed for work in conditions where the dispersed phase concentration does not exceed 10 x TLV. Multi-layered filtration material protects the respiratory system. Nose clip and polyurethane foam seal guarantee comfortable use. The headband made from braided rubber threads ensures perfect fit of the mask to the face.
- NORM: EN 149

Code	Quantity per package		
L1200300	5	x	100

**3 FFP1 FOLDABLE DUST-PROOF MASKS WITH A VALVE**

• ПРОТИВОПЫЛЬНЫЕ МАСКИ СКЛАДЫВАЮЩИЕСЯ FFP1 С КЛАПАНОМ  
• FALTBARE STAUBMASKEN FFP1 MIT VENTIL

**FFP1**



**Kat. III**  
**Cat. III**

- MATERIAL: Multi-layered filtration material.
- Designed for work conditions where the dispersed phase concentration does not exceed 4 x TLV. The foldable mask structure makes their storage easier. Multi-layered filtration material protects the respiratory system. Nose clip and polyurethane foam seam guarantee comfortable use. The valve offers easier exhalation. The head straps made from braided rubber threads ensure perfect fit of the mask to the face. Head strap clips ensure smooth adjustment.
- NORM: EN 149

Code	Quantity per package		
L1200600	5	x	150

**6 FFP2 DUST-PROOF MASKS WITH A VALVE**

• РЕСПИРАТОРЫ ПРОТИВОПЫЛЬНЫЕ FFP2 С КЛАПАНОМ  
• STAUBMASKEN FFP2 MIT VENTIL

**FFP2**



**Kat. III**  
**Cat. III**

- MATERIAL: Multi-layered filtration material.
- Designed for work in conditions where the dispersed phase concentration does not exceed 10 x TLV. Multi-layered filtration material protects the respiratory system. Nose clip and polyurethane foam seal guarantee comfortable use. The valve facilitates air exhalation. The headband made from braided rubber threads ensures perfect fit of the mask to the face.
- NORM: EN 149

Code	Quantity per package		
L1200400	3	x	100



**1 FFP2 FOLDABLE DUST-PROOF MASKS WITH A VALVE**

- ПРОТИВОПЫЛЬНЫЕ МАСКИ СКЛАДЫВАЮЩИЕСЯ FFP2 С КЛАПАНОМ
- FALTBARE STAUBMASKEN FFP2 MIT VENTIL

FFP2



Kat. III  
Cat. III

- MATERIAL: Multi-layered filtration material.
- Designed for work conditions where the dispersed phase concentration does not exceed 10 x TLV. The foldable mask structure makes their storage easier. Multi-layered filtration material protects the respiratory system. Nose clip and polyurethane foam seam guarantee comfortable use. The valve offers easier exhalation. The head straps made from braided rubber threads ensure perfect fit of the mask to the face. Head strap clips ensure smooth adjustment.
- NORM: EN 149

Code	Quantity per package		
L1200700	5	x	150

**4 FFP3 DUST-PROOF MASKS WITH A VALVE**

- ПРОТИВОПЫЛЬНЫЕ МАСКИ И СКЛАДЫВАЮЩИЕСЯ FFP3 С КЛАПАНОМ
- FALTBARE STAUBMASKEN FFP3 MIT VENTIL

FFP3



Kat. III  
Cat. III

- MATERIAL: Multi-layered filtration material.
- Designed for work conditions where the dispersed phase concentration does not exceed 30 x TLV. The foldable mask structure makes their storage easier. Multi-layered filtration material protects the respiratory system. Nose clip and polyurethane foam seam guarantee comfortable use. The valve offers easier exhalation. The head straps made from braided rubber threads ensure perfect fit of the mask to the face. Head strap clips ensure smooth adjustment.
- NORM: EN 149

Code	Quantity per package		
L120080S	1	x	200

**2 FFP2 DUST-PROOF MASKS WITH A VALVE AND AN ACTIVATED CARBON LAYER**

- ПРОТИВОПЫЛЬНЫЕ МАСКИ FFP2 С КЛАПАНОМ СО СЛОЕМ АКТИВИРОВАННОГО УГЛЯ
- STAUBMASKEN FFP2 MIT VENTIL MIT AKTIVKOHLESCHICHT

FFP2



Kat. III  
Cat. III

- MATERIAL: Multi-layered filtration material.
- Designed for work conditions where the dispersed phase concentration does not exceed 10 x TLV. The activated carbon layer reduces the adverse effects related to odours. Multi-layered filtration material protects the respiratory system. Nose clip and polyurethane foam seam guarantee comfortable use. The valve offers easier exhalation. The head straps made from braided rubber threads ensure perfect fit of the mask to the face. Head strap clips ensure smooth adjustment.
- NORM: EN 149

Code	Quantity per package		
L120100S	5	x	200

**5 FFP1 DUST-PROOF MASKS WITHOUT A VALVE**

- РЕСПИРАТОРЫ ПРОТИВОПЫЛЬНЫЕ FFP1 БЕЗ КЛАПАНА
- STAUBMASKEN FFP1 OHNE VENTIL

FFP1



Kat. III  
Cat. III

- MATERIAL: Multi-layered filtration material.
- Designed for work in conditions where the dispersed phase concentration does not exceed 4 x TLV. Multi-layered filtration material protects the respiratory system. Nose clip and polyurethane foam seal guarantee comfortable use. The headband made from braided rubber threads ensures perfect fit of the mask to the face.
- NORM: EN 149

Code	Quantity per package		
46006	5	x	100

**3 FFP3 DUST-PROOF MASKS WITH A VALVE**

- РЕСПИРАТОРЫ ПРОТИВОПЫЛЬНЫЕ FFP3 С КЛАПАНОМ
- STAUBMASKEN FFP3 MIT VENTIL

FFP3



Kat. III  
Cat. III

- MATERIAL: Multi-layered filtration material.
- Designed for work in conditions where the dispersed phase concentration does not exceed 30 x TLV. Multi-layered filtration material protects the respiratory system. Nose clip and polyurethane foam seal guarantee comfortable use. The valve facilitates air exhalation. The headband made from braided rubber threads ensures perfect fit of the mask to the face. The insert improves tightness.
- NORM: EN 149

Code	Quantity per package		
L120050S	1	x	140

**6 FFP1 DUST-PROOF MASKS WITH A VALVE**

- РЕСПИРАТОРЫ ПРОТИВОПЫЛЬНЫЕ FFP1 С КЛАПАНОМ
- STAUBMASKEN FFP1 MIT VENTIL

FFP1



Kat. III  
Cat. III

- MATERIAL: Multi-layered filtration material.
- Designed for work conditions where the dispersed phase concentration does not exceed 4 x TLV. Multi-layered filtration material protects the respiratory system. Nose clip and polyurethane foam seal guarantee comfortable use. The valve facilitates air exhalation. The headband made from braided rubber threads ensures perfect fit of the mask to the face.
- NORM: EN 149

Code	Quantity per package		
46007	3	x	100

PROLINE

LAHTI PRO

MEGA

JUCO

OTHER BRANDS

ERDI

KLINGSPOR

EXPRESS

ACTION CAN

TRAYTON

VULCAN

**1 HALF-FACE SMOG MASK WITH TWO VALVES AND ACTIVATED CHARCOAL LAYER**

- РЕСПИРАТОР ДЛЯ ЗАЩИТЫ ОТ СМОГА С 2-Я КЛАПАНАМИ И СЛОЕМ АКТИВНОГО УГЛЯ
- ANTI-SMOG-HALBMASKE MIT ZWEI VENTILEN UND EINER AKTIVKOHLESCHICHT



- MATERIAL: Non-woven fabric with active carbon.
- Foldable mask design makes them easy to store. Multi-layer filter provides respiratory protection. A nose clip and polyurethane foam gasket guarantee comfortable use. Two valves makes exhaling easier. Headbands made of rubber threads in a braid ensure perfect adhesion of the mask to the face. Headband holders allow smooth adjustment.

Code	Quantity per package	
46008	1	200

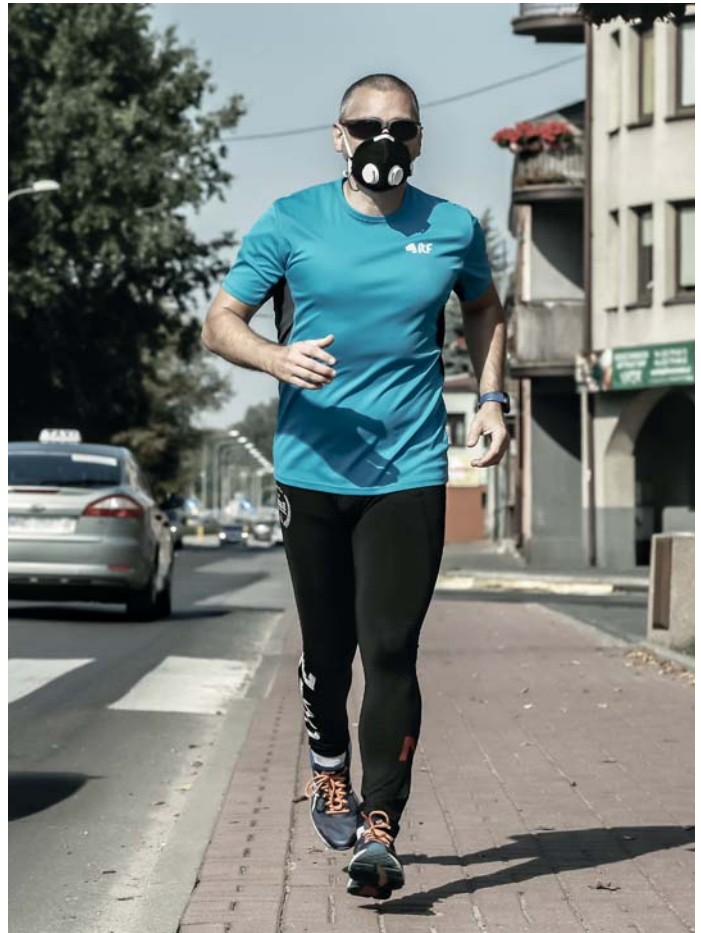

**2 SILICONE HALF-MASK "EURMASK"**

- РЕСПИРАТОР СИЛИКОНОВЫЙ „EURMASK” • SILIKONHALBMASKE „EURMASK”



- MATERIAL: silicon
- High comfort of work and good fit to the user's face in workplaces with gas, vapour and mist hazard. After combining with appropriate absorbers or filtering absorbers with diameter 70 mm it can be used for protecting respiratory tract against hazardous chemicals.

Application:

- With absorbers 46055 - A1 - organic vapours up to the concentration of 0.1% in air, 46058 - A1B1E1K1 - any other gases up to the concentration of 0.1% in air

- With filtering absorbers 46056 - A1P2 - organic vapours up to the concentration of 0.1% in air and dusts up to 10 X TLV. Easy operation. Absorbers not included. Half-masks are permitted only when the oxygen concentration in the air is not lower than 17% of the volume.

- NORM: EN 149

Code	Type	
46063	two absorbers	16

**3 ABSORBERS FOR HALF-MASKS "EURMASK"**

- ФИЛЬТРЫ ДЛЯ РЕСПИРАТОРОВ "EURMASK"
- FILTER FÜR HALBMASKEN „EURMASK"



- A1 - vapours and gases of organic substances
- B1 - vapours and gases of inorganic substances
- E1 - acid vapours
- K1 - vapours of ammonium hydroxide and its organic derivatives
- P2 - dust, smoke and mist - class 2 - longer lifecycle
- ABEK - mixtures of toxic gases and vapours (multi-gas)
- In the set of 2. 46058 - EN 14387 standard.
- NORM: EN 149, EN 14387

Code	Typ	
46055	A1	4/64
46056	A1, P2	4/64
46058	A1, B1, E1, K1 (ABEK)	4/64

# WORK AT HEIGHT

connector ropes

safety harness

safety shock absorbers

self-locking devices

snaphooks



PROLINE

LAHTI PRO

MEGA

JUCCO

OTHER BRANDS

ERDI

KLINGSPOR

EXPRESS

ACTION CAN

TRAYTON

VULCAN

**1 SAFETY HARNESS**

• СТРАХОВОЧНАЯ ПРИВЯЗЬ • SICHERHEITSGURT



Kat. III  
Cat. III CE

- MATERIAL: polyester
- The rear back catch in the form of a metal clamp. Two front textile catches. A belt for guided harness hanging with side clamps. Adjustable breast strap and thigh straps.
- NORM: EN 361

Code		
L8010300	x	15

**2 SAFETY HARNESS**

• СТРАХОВОЧНАЯ ПРИВЯЗЬ • SICHERHEITSGURT



Kat. III  
Cat. III CE

- MATERIAL: polyester
- The rear back catch in the form of a metal clamp. Two front textile catches. Adjustable breast strap and thigh straps.
- NORM: EN 361

Code		
L8010200	x	40

**3 SAFETY HARNESS**

• СТРАХОВОЧНАЯ ПРИВЯЗЬ • SICHERHEITSGURT



Kat. III  
Cat. III CE

- MATERIAL: polyester
- The rear back catch in the form of a metal clamp. Adjustable breast strap and thigh straps.
- NORM: EN 361

Code		
L8010100	x	40

**4 KIT FOR WORK AT HEIGHT**

• КОМПЛЕКТ ДЛЯ РАБОТ НА ВЫСОТЕ • SET FÜR HÖHENARBEITEN



Kat. III  
Cat. III CE

- MATERIAL: polyester
- The set includes: Safety harness L8010200: the rear back catch in the form of a metal clamp. Two front textile catches. Adjustable breast strap and thigh straps. Safety shock absorber L8020100: length: 1.5 m, tape endings stitched together and covered with a protective sleeve. Steel snaphooks with a lock L8050100, 2 pieces: maximum opening: 18 mm. With a locking nut.
- NORM: EN 361, EN 362, EN 355

Code		
L8060100	x	25

**5 SELF-LOCKING DEVICE**

• УСТРОЙСТВО САМОТОРМОЗЯЩЕЕ • SELBSTBREMSSENDE VORRICHTUNG



Kat. III  
Cat. III CE

- Working length: 6 m. Finished with a snaphook with a lock on the fixing eye side and with a revolving hook on the opposite side. Integrated locking mechanism.
- NORM: EN 360

Code		
L8040300	x	10

**6 SELF-LOCKING DEVICE**

• УСТРОЙСТВО САМОТОРМОЗЯЩЕЕ • SELBSTBREMSSENDE VORRICHTUNG



Kat. III  
Cat. III CE

- Working length: 2.5 m. Finished with steel snaphooks with a lock. With a safety shock absorber. Integrated locking mechanism.
- NORM: EN 360

Code		
L8040200	x	20

**1 SAFETY SHOCK ABSORBER WITH A DOUBLE LANYARD**

• СТРАХОВОЧНЫЙ СТРОП С АМОРТИЗАТОРОМ – ДВОЙНОЙ • SICHERHEITSSTOSSDÄMPFER MIT DOPPELTER LEINE



Kat. III  
Cat. III CE

- MATERIAL: polyester
- Length: 1.75 m. Lanyard endings with steel snaphooks. Lanyard loops with extra eyelets protecting from abrasion. Finished with a steel snaphook with a lock on the shock absorber side.
- NORM: EN 355

Code	Image of box
L8020200	10

**2 SAFETY SHOCK ABSORBER WITH A LANYARD**

• ПРЕДОХРАНИТЕЛЬНЫЙ АМОРТИЗАТОР С ТРОСОМ • SICHERHEITSSTOSSDÄMPFER MIT SCHNUR



Kat. III  
Cat. III CE

- MATERIAL: polyester
- Length: 1.75 m. Endings with steel snaphooks. Lanyard loops with eyelets protecting from abrasion.
- NORM: EN 355

Code	Image of box
L8020300	20

**3 SAFETY SHOCK ABSORBER**

• СТРАХОВОЧНЫЙ АМОРТИЗАТОР • SICHERHEITSSTOSSDÄMPFER



Kat. III  
Cat. III CE

- MATERIAL: polyester
- Length: 1.5 m. Tape endings stitched together and covered with a protective sleeve.
- NORM: EN 355

Code	Image of box
L8020100	50

**4 LANYARD FOR SUPPORTED WORK**

• СТРОП ДЛЯ РАБОТЫ С ПОДДЕРЖКОЙ • LEINE FÜR GESTÜTZTE ARBEITEN



Kat. III  
Cat. III CE

- MATERIAL: polyester
- Adjustable length: 0.85 m – 1.35 m. Lanyard ending with an eyelet protecting from abrasion.
- NORM: EN 358

Code	Image of box
L8030100	50

**5 CONNECTION ROPES**

• СТРОПЫ ПРИСОЕДИНИТЕЛЬНЫЕ • VERBINDUNGSLEINEN



Kat. III  
Cat. III CE

- MATERIAL: polyester
- Rope endings with eyelets protecting from abrasion.
- NORM: EN 353-2

Code	Length (m)	Image of box
L8030210	10	20
L8030220	20	10

**6 SELF LOCKING DEVICE**

• САМОЗАЖИМНОЕ УСТРОЙСТВО • SELBSTSCHLIESSENDE VORRICHTUNG



Kat. III  
Cat. III CE

- MATERIAL: polyester
- With a rope for connecting with the user's harness. Lever with automatic locking system. To be used with connection lanyards dia. 14 mm (L8030210, L8030220).
- NORM: EN 353-2

Code	Image of box
L8040100	30

**7 STEEL SNAPHOOK WITH A LOCK**

• КАРАБИН СТАЛЬНОЙ С БЛОКИРОВКОЙ • STAHLKARABINERHABEN MIT BLOCKADE



Kat. III  
Cat. III CE

- MATERIAL: steel
- Maximum opening: 18 mm. With a locking nut.
- NORM: EN 362

Code	Image of box
L8050100	150

# HAND PROTECTION

**gloves:**

- anti-vibration
  - antistatic
  - cotton
  - cowhide
  - disposable
  - dotted
  - furniture cowhide
  - goatskin
  - non-slip
  - padded
  - reinforced
  - synthetic leather
  - welding
  - workshop
- and many others



**1 REFLECTIVE PVC-REINFORCED PROTECTIVE GLOVES**

- ПЕРЧАТКИ ЗАЩИТНЫЕ СВЕТООТРАЖАЮЩИЕ, УПРОЧНЁННЫЕ ЭЛЕМЕНТАМИ ПВХ
- REFLEXHANDSCHUHE MIT PVC-ELEMENTEN VERSTÄRKT



Kat. I  
Cat. I CE

- MATERIAL: PVC, microfibre, elastane, reflective fabric, neoprene.
- The top made from flexible fabric ensures perfect fit to hands. Reflective fabric on the fingers improves the user's visibility. Multiple PVC reinforcements on the grip part, fingers and thumb protect from abrasion. Terry on the thumb collects perspiration. Long, flexible cuff with a Velcro fastening ensures safety and comfort of use.
- NORM: EN 420

Size	Code		
9 (L)	L280709K	x	10/ 100
10 (XL)	L280710K	x	10/ 100
11 (2XL)	L280711K	x	10/ 100

**2 PROTECTIVE GLOVES COVERED WITH NON-SLIP SILICONE MESH**

- ПЕРЧАТКИ ЗАЩИТНЫЕ, ПОКРЫТЫЕ ПРОТИВОСКОЛЬЗЯЩЕЙ СИЛИКОНОВОЙ СЕТКОЙ
- SCHUTZHANDSCHUHE MIT ANTI-RUTSCH- NETZ AUS SILIKON



Kat. I  
Cat. I CE

- MATERIAL: polyester, nylon, elastane, microfibre, silicone
- Silicone mesh on the glove palm improves comfort of work with slippery objects. SBR pads protect from corns and vibrations. Flexible elastane layers ensure perfect fit to the hand. Flexible cuff with a Velcro fastener ensures comfort.
- NORM: EN 420

Size	Code		
8 (M)	L280108K	x	10/ 100
9 (L)	L280109K	x	10/ 100
10 (XL)	L280110K	x	10/ 100
11 (2XL)	L280111K	x	10/ 100



### 1 PROTECTIVE GLOVES COVERED WITH NON-SLIP SILICONE

- ПЕРЧАТКИ ЗАЩИТНЫЕ, ПОКРЫТЫЕ ПРОТИВОСКОЛЬЗЯЩИМ СИЛИКОНОМ
- HANDSCHUHE MIT ANTI-RUTSCH-SILIKONBESCHICHTUNG



Kat. I  
Cat. I

- MATERIAL: microfibre, polyester, nylon, silicone
- The top made from flexible fabric ensures perfect fit. Silicone pattern on the glove palm improves comfort of work with slippery objects. PVC reinforcement on the index finger protects from abrasion. Reflective material on the top improves the user's visibility. Flexible cuff with a Velcro fastening ensures comfort of use.
- NORM: EN 420

Size	Code		
8 (M)	L281108K	x	10/100
9 (L)	L281109K	x	10/100
10 (XL)	L281110K	x	10/100
11 (2XL)	L281111K	x	10/100

### 2 PROTECTIVE GLOVES WITH PVC PADDING

- ПЕРЧАТКИ ЗАЩИТНЫЕ С ПВХ ПОДУШКОЙ • SCHUTZHANDSCHUHE MIT PVC-KISSEN



Kat. I  
Cat. I

- MATERIAL: microfibre, elastane, PVC, neoprene
- Additional PVC reinforcements on fingertips and part of index finger and thumb prevent rapid wear of the glove. The top made from flexible elastane ensures perfect fit. Thick, soft PVC pad protects from corns and vibrations, and prevents excess wear of the grip part. Elastic cuff with Velcro fastener ensures comfort.
- NORM: EN 420

Size	Code		
9 (L)	L280809K	x	10/100
10 (XL)	L280810K	x	10/100
11 (2XL)	L280811K	x	10/100

### 3 HIGH VISIBILITY PROTECTIVE GLOVES WITH ANTI-CARD PADDING

- ПЕРЧАТКИ ЗАЩИТНЫЕ ПОВЫШЕННОЙ ВИДИМОСТИ, С ПОДУШКОЙ ЗАЩИЩАЮЩЕЙ ОТ МОЗОЛЕЙ
- SCHUTZHANDSCHUHE MIT ERHÖHTER SICHTBARKEIT UND BLASENSCHUTZKISSEN



Kat. I  
Cat. I

- MATERIAL: microfibre, elastane
- The top of the glove, made from flexible elastane with improved visibility, ensures perfect fit to the hand and increases the user's visibility. Reinforcements on the grip part protect from excess wear. Soft pad on the grip part protects from corns and vibrations. Flexible cuff with a Velcro fastener ensures comfort.
- NORM: EN 420

Size	Code		
8 (M)	L280508K	x	6/72
9 (L)	L280509K	x	6/72
10 (XL)	L280510K	x	6/72
11 (2XL)	L280511K	x	6/72

### 4 PVC-REINFORCED PROTECTIVE GLOVES

- ПЕРЧАТКИ ЗАЩИТНЫЕ, УПРОЧНЁННЫЕ ПВХ ЭЛЕМЕНТАМИ • HANDSCHUHE MIT PVC-ELEMENTEN VERSTÄRKT



Kat. I  
Cat. I

- MATERIAL: Mikrofibra, PVC, elasthan, polyester, neopren.
- The top of the glove, made from flexible elastane, ensures perfect fit to the hand. Reinforcements on the grip part protect from excess wear. Terry on the thumb collects perspiration.
- NORM: EN 420

Size	Code		
9 (L)	L280909K	x	6/72
10 (XL)	L280910K	x	6/72
11 (2XL)	L280911K	x	6/72



### 1 PVC-COATED PROTECTIVE GLOVES

• ПЕРЧАТКИ ЗАЩИТНЫЕ С ПВХ ПОКРЫТИЕМ • SCHUTZHANDSCHUHE MIT PVC-BESCHICHTUNG



Kat. I  
Cat. I

- MATERIAL: polyester, cotton, elastane, neoprene, PVC
- The glove palm, with rough surface, ensures perfect grip. The top of the glove, made from flexible fabric, ensures perfect fit to the hand. Terry on the thumb collects perspiration. Flexible cuff with a Velcro fastener ensures comfort.
- NORM: EN 420

Size	Code		
8 (M)	L281008K	x	6/60
9 (L)	L281009K	x	6/60
10 (XL)	L281010K	x	6/60
11 (2XL)	L281011K	x	6/60

### 2 HIGH-VISIBILITY PROTECTIVE GLOVES

• ПЕРЧАТКИ ЗАЩИТНЫЕ, ПОВЫШЕННОЙ ВИДИМОСТИ  
• SCHUTZHANDSCHUHE MIT ERHÖHTER SICHTBARKEIT



Kat. I  
Cat. I

- MATERIAL: microfibre, elastane, polyester
- The top of the glove is made from high-visibility fabric. Ventilated microfibre on the fingers ensures air circulation inside the glove. Flexible cuff with a velcro fastener ensures comfort.
- NORM: EN 420

Size	Code		
8 (M)	L280308K	x	6/72
9 (L)	L280309K	x	6/72
10 (XL)	L280310K	x	6/72
11 (2XL)	L280311K	x	6/72

### 3 TWO-FINGER ANTI-CARD PADDED PROTECTIVE GLOVES

• ПЕРЧАТКИ ЗАЩИТНЫЕ БЕЗ 3 ПАЛЬЦЕВ, С ПОДУШКОЙ ЗАЩИЩАЮЩЕЙ ОТ МОЗОЛЕЙ  
• SCHUTZHANDSCHUHE OHNE 3 FINGER MIT BLASENSCHUTZKISSEN



Kat. I  
Cat. I

- MATERIAL: microfibre, elastane
- Soft pad on the grip part protects from corns and vibrations. The top of the glove, made from flexible elastane, prevents hand sweating and ensures perfect fit. Open finger tips offer high manual dexterity, enabling the user to do high-precision works and feel the object held. The insets on the tips of middle fingers make it easier to remove the glove. Elastic cuff with Velcro fastener ensures comfort.
- NORM: EN 420

Size	Code		
8 (M)	L281208K	x	6/72
9 (L)	L281209K	x	6/72
10 (XL)	L281210K	x	6/72
11 (2XL)	L281211K	x	6/72

### 4 FINGERLESS ANTI-CARD PADDED PROTECTIVE GLOVES

• ПЕРЧАТКИ ЗАЩИТНЫЕ БЕЗ ПАЛЬЦЕВ, С ПОДУШКОЙ ЗАЩИЩАЮЩЕЙ ОТ МОЗОЛЕЙ  
• FINGERLOSE SCHUTZHANDSCHUHE MIT BLASENSCHUTZKISSEN



Kat. I  
Cat. I

- MATERIAL: microfibre, elastane
- Open finger tips enable the user to feel the object held and do high-precision works. The top of the glove, made from flexible elastane, ensures perfect fit. Ventilated microfibre on the fingers ensures air circulation inside the glove. The insets on the tips of middle fingers make it easier to remove the glove. Soft, reinforced pad on the grip part protects from corns and vibrations. Elastic cuff with Velcro fastener ensures comfort.
- NORM: EN 420

Size	Code		
8 (M)	L280608K	x	6/72
9 (L)	L280609K	x	6/72
10 (XL)	L280610K	x	6/72
11 (2XL)	L280611K	x	6/72

PROLINE

LAHTI PRO

MEGA

JUCO

OTHER BRANDS

ERDI

KLINGSPOR

EXPRESS

ACTION CAN

TRYTON

VULCAN

### 1 SYNTHETIC LEATHER PROTECTIVE GLOVES

• ЗАЩИТНЫЕ ПЕРЧАТКИ ИЗ СИНТЕТИЧЕСКОЙ КОЖИ • SCHUTZHANDSCHUHE AUS KUNSTLEDER



Kat. I  
Cat. I CE

- MATERIAL: microfibre, elastane
- Single-piece gripping part increases the glove's durability.
- NORM: EN 420

Size	Code		
8 (M)	L271508K	x	12/120
9 (L)	L271509K	x	12/120
10 (XL)	L271510K	x	12/120
11 (2XL)	L271511K	x	12/120

### 2 SYNTHETIC LEATHER PROTECTIVE GLOVES

• ЗАЩИТНЫЕ ПЕРЧАТКИ ИЗ СИНТЕТИЧЕСКОЙ КОЖИ  
• SCHUTZHANDSCHUHE AUS KUNSTLEDER



Kat. I  
Cat. I CE

- MATERIAL: microfibre, elastane
- Single-piece gripping part increases the glove's durability. Wide cuff provides additional wrist protection.
- NORM: EN 420

Size	Code		
7 (S)	L271407K	x	12/120
8 (M)	L271408K	x	12/120
9 (L)	L271409K	x	12/120



**1 PIGSKIN PROTECTIVE GLOVES**

• ПЕРЧАТКИ ЗАЩИТНЫЕ ИЗ СВИНОЙ КОЖИ • SCHUTZHANDSCHUHE AUS SCHWEINSLEDER



Kat. I  
Cat. I

- MATERIAL: pigskin, microfibre, elastane, polyester, neoprene
- The top of the glove, made from flexible elastane, ensures perfect fit. Ventilated microfibre on the fingers ensures air circulation inside the glove. Double layer of leather on the part of thumb prevents rapid wear. The grip part made from a single leather piece increases the glove durability. Flexible cuff with a Velcro fastener ensures comfort.
- NORM: EN 420

Size	Code		
9 (L)	L280409K	x	10/ 100
10 (XL)	L280410K	x	10/ 100
11 (2XL)	L280411K	x	10/ 100

**2 GOATSKIN PROTECTIVE GLOVES**

• ПЕРЧАТКИ ЗАЩИТНЫЕ ИЗ КОЗЬЕЙ КОЖИ • SCHUTZHANDSCHUHE AUS ZIEGENLEDER



Kat. I  
Cat. I

- MATERIAL: goatskin, cotton elastane
- The grip part made from a single leather piece increases glove durability. The top made from elastic material ensures perfect fit to the hand. Flexible cuff with a Velcro fastener ensures comfort.
- NORM: EN 420

Size	Code		
8 (M)	L270808K	x	12/ 120
9 (L)	L270809K	x	12/ 120
10 (XL)	L270810K	x	12/ 120
11 (2XL)	L270811K	x	12/ 120

**3 GOAT LEATHER PROTECTIVE GLOVES**

• ПЕРЧАТКИ ЗАЩИТНЫЕ ИЗ КОЗЬЕЙ КОЖИ • SCHUTZHANDSCHUHE AUS ZIEGENLEDER



Kat. I  
Cat. I

- MATERIAL: goatskin, cotton, elastane
- Single-piece leather grip increases the glove's durability. Inserts of high-visibility material. Elastic Velcro closed welt provides comfort.
- NORM: EN 420

Size	Code		
8 (M)	L271808K	x	12/ 120
9 (L)	L271809K	x	12/ 120
10 (XL)	L271810K	x	12/ 120
11 (2XL)	L271811K	x	12/ 120

**4 GOATSKIN PROTECTIVE GLOVES**

• ПЕРЧАТКИ ЗАЩИТНЫЕ ИЗ КОЗЬЕЙ КОЖИ • SCHUTZHANDSCHUHE AUS ZIEGENLEDER



EN 388  
2123x



Kat. II  
Cat. II

- MATERIAL: goatskin, cotton, elastane
- The grip part made from a single leather piece increases glove durability. Elastic cuff with Velcro ensures comfort.
- NORM: EN 420, EN 388

Size	Code		
8 (M)	L270208K	x	12/ 120
9 (L)	L270209K	x	12/ 120
10 (XL)	L270210K	x	12/ 120
11 (2XL)	L270211K	x	12/ 120

## 1 GOATSKIN PROTECTIVE GLOVES

• ПЕРЧАТКИ ЗАЩИТНЫЕ ИЗ КОЗЬЕЙ КОЖИ • SCHUTZHANDSCHUHE AUS ZIEGENLEDER



Kat. I  
Cat. I

- MATERIAL: goatskin, cotton
- The grip part made from a single leather piece increases glove durability. Elastic cuff with Velcro ensures comfort.
- NORM: EN 420

Size	Code		
8 (M)	L270608K	x	12/120
9 (L)	L270609K	x	12/120
10 (XL)	L270610K	x	12/120
11 (2XL)	L270611K	x	12/120

## 2 GOATSKIN PROTECTIVE GLOVES

• ПЕРЧАТКИ ЗАЩИТНЫЕ ИЗ КОЗЬЕЙ КОЖИ • SCHUTZHANDSCHUHE AUS ZIEGENLEDER



Kat. II  
Cat. II

- MATERIAL: goatskin, cotton, elastane
- The grip part made from a single leather piece increases glove durability.
- NORM: EN 420, EN 388

Size	Code		
8 (M)	L270708K	x	12/120
9 (L)	L270709K	x	12/120
10 (XL)	L270710K	x	12/120
11 (2XL)	L270711K	x	12/120

## 3 GOATSKIN PROTECTIVE GLOVES

• ПЕРЧАТКИ ЗАЩИТНЫЕ ИЗ КОЗЬЕЙ КОЖИ • SCHUTZHANDSCHUHE AUS ZIEGENLEDER



Kat. I  
Cat. I

- MATERIAL: goatskin, cotton, elastane
- The grip part made from a single leather piece increases glove durability.
- NORM: EN 420

Size	Code		
8 (M)	L271608K	x	12/120
9 (L)	L271609K	x	12/120
10 (XL)	L271610K	x	12/120
11 (2XL)	L271611K	x	12/120



**1 GOATSKIN PROTECTIVE GLOVES**

• ПЕРЧАТКИ ЗАЩИТНЫЕ ИЗ КОЗЬЕЙ КОЖИ • SCHUTZHANDSCHUHE AUS ZIEGENLEDER



Kat. I  
Cat. I

- MATERIAL: goatskin
- Gloves made entirely from leather are more durable. A wrist cuff ensures high work comfort.
- NORM: EN 420

Size	Code		
8 (M)	L271008K	x	12/120
9 (L)	L271009K	x	12/120
10 (XL)	L271010K	x	12/120
11 (2XL)	L271011K	x	12/120

**2 GOATSKIN PROTECTIVE GLOVES**

• ПЕРЧАТКИ ЗАЩИТНЫЕ ИЗ КОЗЬЕЙ КОЖИ • SCHUTZHANDSCHUHE AUS ZIEGENLEDER



Kat. I  
Cat. I

- MATERIAL: goatskin
- Gloves made entirely from leather are more durable. Ended with a cuff with extra wrist protection made from leather.
- NORM: EN 420

Size	Code		
8 (M)	L271108K	x	12/120
9 (L)	L271109K	x	12/120
10 (XL)	L271110K	x	12/120
11 (2XL)	L271111K	x	12/120

**3 GOAT LEATHER PROTECTIVE GLOVES**

• ПЕРЧАТКИ ЗАЩИТНЫЕ ИЗ КОЗЬЕЙ КОЖИ • SCHUTZHANDSCHUHE AUS ZIEGENLEDER



Kat. I  
Cat. I

- MATERIAL: goatskin, cotton
- Single-piece leather grip increases the glove's durability. Finished with a welt.
- NORM: EN 420

Size	Code		
8 (M)	L271708W		10
9 (L)	L271709W		10
10 (XL)	L271710W		10
11 (2XL)	L271711W		10

12 pairs in a pack.

**4 GOAT LEATHER PROTECTIVE GLOVES**

• ПЕРЧАТКИ ЗАЩИТНЫЕ ИЗ КОЗЬЕЙ КОЖИ • SCHUTZHANDSCHUHE AUS ZIEGENLEDER



Kat. I  
Cat. I

- MATERIAL: goatskin, cotton
- The grip part made from a single leather piece increases glove durability. Stiffened cuff ensures extra wrist protection.
- NORM: EN 420

Size	Code		
10 (XL)	L270910K	x	12/120

PROLINE

LAHTI PRO

MEGA

JUCO

OTHER BRANDS

ERDI

KLINGSPOR

EXPRESS

ACTION CAN

TRYTON

VULCAN

**1 COWHIDE PROTECTIVE GLOVES**

• ПЕРЧАТКИ ЗАЩИТНЫЕ ИЗ БЫЧЬЕЙ КОЖИ • SCHUTZHANDSCHUHE AUS RINDSLIEDER



Kat. I  
Cat. I

- MATERIAL: split cowhide, cotton
- The grip part made from a single leather piece increases glove durability. High comfort of work thanks to the inner lining.
- NORM: EN 420

Size	Code		
10 (XL)	L270110K	x	12/120

**2 COWHIDE PROTECTIVE GLOVES**

• ПЕРЧАТКИ ЗАЩИТНЫЕ ИЗ БЫЧЬЕЙ КОЖИ • SCHUTZHANDSCHUHE AUS RINDSLIEDER



Kat. I  
Cat. I

- MATERIAL: split cowhide, cotton
- Stitched glove grip part. High comfort of work thanks to the inner lining.
- NORM: EN 420

Size	Code	
10 (XL)	L270510W	10

12 pairs in a pack.



**3 FURNITURE COWHIDE PROTECTIVE GLOVES**

• ЗАЩИТНЫЕ ПЕРЧАТКИ ИЗ МЕБЕЛЬНОЙ КОЖИ КРУПНОГО РОГАТОГО СКОТА  
• SCHUTZHANDSCHUHE AUS MÖBELRINDSLIEDER



Kat. I  
Cat. I

- MATERIAL: cowhide, cotton
- Stitched contact part. Leather cuff ensures extra wrist protection.
- NORM: EN 420

Size	Code	
10 (XL)	L271310W	10

12 pairs in a pack.

**1 FURNITURE PROTECTIVE GLOVES**

• ПЕРЧАТКИ ЗАЩИТНЫЕ ИЗ МЕБЕЛЬНОЙ КОЖИ • SCHUTZHANDSCHUHE AUS MÖBELLEDER



**Kat. I** **Cat. I**

- MATERIAL: full-grain leather; cotton
- Stitched grip part of the glove. High comfort of work thanks to the inner lining.
- NORM: EN 420

Size	Code		
10 (XL)	L271210W	x	10

12 pairs in a pack.

**2 WELDING GLOVES**

• ПЕРЧАТКИ ЗАЩИТНЫЕ СВАРОЧНЫЕ • SCHWEISSERSCHUTZHANDSCHUHE



**Kat. II** **Cat. II**

- MATERIAL: split cowhide, cotton
- Glove length 35 cm. The grip part made from a single leather piece. High comfort of work and improved thermal insulation thanks to the inner lining. Non-flammable thread on the seams increases glove resistance to heat. High resistance to chafing, tearing and piercing (resistance level 4). High resistance to flame, convection heat and small splinters of melted metal (resistance level 4). Application: welding.
- NORM: EN 420, EN 407, EN 388, EN12477-A

Size	Code		
11 (2XL)	L270311K	x	12/60

**3 WELDING GLOVES**

• ПЕРЧАТКИ ЗАЩИТНЫЕ СВАРОЧНЫЕ • SCHWEISSERSCHUTZHANDSCHUHE



**Kat. II** **Cat. II**

- MATERIAL: goatskin, cowhide
- Glove length 35 cm. Single-piece leather grip increases the glove's durability. Non-flammable thread at the seams improves the glove's resistance to high temperatures. High ignition resistance [level 4 resistance]. Finished with a welt. Application: Welding
- NORM: EN 420, EN 407, EN388, EN12477-A

Size	Code		
10 (XL)	L271910K	x	12/120

**4 WELDING GLOVES**

• ПЕРЧАТКИ ЗАЩИТНЫЕ СВАРОЧНЫЕ • SCHWEISSERSCHUTZHANDSCHUHE



**Kat. II** **Cat. II**

- MATERIAL: split cowhide, cotton
- Glove length 35 cm. The grip part made from a single leather piece. High resistance to flame, convection heat and small splinters of melted metal (resistance level 4). Application: welding.
- NORM: EN 420, EN 407, EN 388, EN12477-A

Size	Code		
11 (2XL)	L270411K	x	12/60

PROLINE

LAHTI PRO

MEGA

JUCO

OTHER BRANDS

ERDI

KLINGSPOR

EXPRESS

ACTION CAN

TRYTON

VULCAN

**1 GLOVES PROTECTING FROM CHAINSAW CUTTING**

• ПЕРЧАТКИ, ЗАЩИЩАЮЩИЕ ОТ ПОРЕЗОВ ЦЕПНОЙ ПИЛОЙ • SCHNITTSCHUTZHANDSCHUHE ZUM KETTENSÄGEN



Kat. III  
Cat. III



- MATERIAL: cow leather, polyamide
- Cut-proof insert on the left glove top prevents cutting with the chain saw moving at 20 m/s. The grip part made from a single leather piece increases glove durability. Extra leather reinforcement on the grip part prevents rapid wear. Ended with a cuff. Application: chainsaw use.
- IMPORTANT: Only the left glove has the said protection from chainsaw cutting on its upper part. The cut-proof insert does not protect the left hand thumb and fingers.
- NORM: EN 388, EN 381-7

Size	Code		
10 (XL)	L290210K	x	10/50
11 (2XL)	L290211K	x	10/50

**2 ANTI-VIBRATION PROTECTIVE GLOVES**

• ПЕРЧАТКИ ЗАЩИТНЫЕ АНТИВИБРАЦИОННЫЕ • ANTI-VIBRATIONSSCHUTZHANDSCHUHE



Kat. II  
Cat. II



- MATERIAL: polyester, rubber
- The grip part of the glove with rubber pads to reduce vibration. High resistance to chafing and tearing (resistance level 4).
- NORM: EN 420, EN 388, EN ISO 10819

Size	Code		
10 (XL)	L290110K	x	12/60

**3 COTTON PROTECTIVE GLOVES**

• ХЛОПКОВЫЕ ЗАЩИТНЫЕ ПЕРЧАТКИ • BAUMWOLLSCHUTZHANDSCHUHE

100%  
COTTON



Kat. I  
Cat. I



- MATERIAL: cotton
- Elastic and stretchy, fit the hand perfectly. Ensure high manual abilities and perfect feel of the object kept in hand. Perfect for use inside other gloves. Finished with a cuff.
- NORM: EN 420

Size	Code	
8 (M)	L290308W	25
9 (L)	L290309W	25
10 (XL)	L290310W	25
11 (2XL)	L290311W	25

12 pairs in a pack.





**1 LATEX COATED PROTECTIVE GLOVES**

• ПЕРЧАТКИ ЗАЩИТНЫЕ С ЛАТЕКСНЫМ ПОКРЫТИЕМ • SCHUTZHANDSCHUHE MIT LATEXBESCHICHTUNG

LATEX

EN 388  
2241



Kat. II  
Cat. II

- MATERIAL: polyester, latex
- Coated with porous latex, improving resistance to chafing and tearing and increasing grip. High-quality knitwear - weave 10. Ended with a cuff.
- NORM: EN 420, EN 388

Size	Code	Box
8 (M)	L210208W	10
9 (L)	L210209W	10
10 (XL)	L210210W	10
11 (2XL)	L210211W	10

Size	Code	Box
9 (L)	L210209K	12/120

L210208W-L210211W 12 pairs in a pack.  
L210209K 1 pair on a card.

**4 LATEX COATED PROTECTIVE GLOVES**

• ПЕРЧАТКИ ЗАЩИТНЫЕ С ЛАТЕКСНЫМ ПОКРЫТИЕМ • SCHUTZHANDSCHUHE MIT LATEXBESCHICHTUNG

LATEX



Kat. I  
Cat. I

- MATERIAL: nylon, latex
- Coated with porous latex, improving resistance to chafing and tearing and increasing grip. Elastic and stretchy, ensure very good grip and high comfort of work. Ended with a cuff.
- NORM: EN 420

Size	Code	Box
7 (S)	L211207W	20
8 (M)	L211208W	20
9 (L)	L211209W	20
10 (XL)	L211210W	20
11 (2XL)	L211211W	20

Size	Code	Box
9 (L)	L211209K	12/240
10 (XL)	L211210K	12/240

L211207W-L211211W 12 pairs in a pack.  
L211209K, L211210K 1 pair on a card.

**2 LATEX COATED PROTECTIVE GLOVES**

• ПЕРЧАТКИ ЗАЩИТНЫЕ С ЛАТЕКСНЫМ ПОКРЫТИЕМ • SCHUTZHANDSCHUHE MIT LATEXBESCHICHTUNG

LATEX



Kat. I  
Cat. I

- MATERIAL: polyester, cotton, latex.
- Coated with porous latex, improving resistance to chafing and tearing and increasing grip. Ended with a cuff.
- NORM: EN 420

Size	Code	Box
8 (M)	L210308W	10
9 (L)	L210309W	10
10 (XL)	L210310W	10
11 (2XL)	L210311W	10

Size	Code	Box
9 (L)	L210309K	12/120

L210308W-L210311W 12 pairs in a pack.  
L210309K 1 pair on a card.

**5 LATEX COATED PROTECTIVE GLOVES**

• ПЕРЧАТКИ ЗАЩИТНЫЕ С ЛАТЕКСНЫМ ПОКРЫТИЕМ • SCHUTZHANDSCHUHE MIT LATEXBESCHICHTUNG

LATEX



Kat. I  
Cat. I

- MATERIAL: polyester, latex
- Coated with porous latex, improving resistance to chafing and tearing and increasing grip. Elastic and stretchy, ensure very good grip and high comfort of work. Ended with a cuff.
- NORM: EN 420

Size	Code	Box
7 (S)	L210507W	20
8 (M)	L210508W	20
9 (L)	L210509W	20
10 (XL)	L210510W	20

Size	Code	Box
9 (L)	L210509K	12/120

L210507W-L210510W 12 pairs in a pack.  
L210509K 1 pair on a card.

**3 LATEX COATED PROTECTIVE GLOVES**

• ПЕРЧАТКИ ЗАЩИТНЫЕ С ЛАТЕКСНЫМ ПОКРЫТИЕМ • SCHUTZHANDSCHUHE MIT LATEXBESCHICHTUNG

LATEX

EN 388  
4141



Kat. II  
Cat. II

- MATERIAL: nylon, polyester, latex
- Coated with porous latex, improving resistance to chafing and tearing and increasing grip. High resistance to chafing, tearing and piercing (resistance level 4). Elastic and stretchy, ensure very good grip and high comfort of work. Ended with a cuff.
- NORM: EN 420, EN 388

Size	Code	Box
7 (S)	L210407W	10
8 (M)	L210408W	10
9 (L)	L210409W	10
10 (XL)	L210410W	10

Size	Code	Box
9 (L)	L210409K	12/120

L210407W-L210410W 12 pairs in a pack.  
L210409K 1 pair on a card.

**6 LATEX COATED PROTECTIVE GLOVES**

• ПЕРЧАТКИ ЗАЩИТНЫЕ С ЛАТЕКСНЫМ ПОКРЫТИЕМ • SCHUTZHANDSCHUHE MIT LATEXBESCHICHTUNG

LATEX



Kat. I  
Cat. I

- MATERIAL: polyester, latex
- Coated with porous latex, improving resistance to chafing and tearing and increasing grip. Elastic and stretchy, ensure very good grip and high comfort of work. Ended with a cuff.
- NORM: EN 420

Size	Code	Box
9 (L)	L211109W	20
10 (XL)	L211110W	20

12 pairs in a pack.

PROLINE  
LAHTI PRO  
MEGA  
JUCO  
OTHER BRANDS  
ERDI  
KLINGSPOR  
EXPRESS  
ACTION CAN  
TRYTON  
VULCAN

**1 LATEX COATED PROTECTIVE GLOVES**

- ПЕРЧАТКИ ЗАЩИТНЫЕ С ЛАТЕКСНЫМ ПОКРЫТИЕМ
- LATEXBESCHICHTETE SCHUTZHANDSCHUHE

LATEX



Kat. I  
Cat. I CE

- MATERIAL: polyester; latex
- Coated with a porous latex foam with a structure that increases resistance to abrasion and tears, and increases adhesion. Flexible and stretchable - ensure very good grip and high work comfort. Finished with a welt.
- NORM: EN 420

Size	Code		
7 (S)	L211507K	x	12/120
8 (M)	L211508K	x	12/120
9 (L)	L211509K	x	12/120

**2 LATEX COATED PROTECTIVE GLOVES**

- ПЕРЧАТКИ ЗАЩИТНЫЕ С ЛАТЕКСНЫМ ПОКРЫТИЕМ
- SCHUTZHANDSCHUHE MIT LATEXBESCHICHTUNG

LATEX



Kat. I  
Cat. I CE

- MATERIAL: polyester; cotton; latex
- Coated with a thick layer of porous latex, improving resistance to chafing and tearing and increasing grip. Additional thick latex surface on the top of the glove protects the metacarpal bones from abrasion. Ended with a cuff.
- NORM: EN 420

Size	Code	
10 (XL)	L210910W	10

Size	Code	
10 (XL)	L210910K	12/120

L210910W 12 pairs in a pack.  
L210910K 1 pair on a card.

**3 LATEX COATED PROTECTIVE GLOVES**

- ПЕРЧАТКИ ЗАЩИТНЫЕ С ЛАТЕКСНЫМ ПОКРЫТИЕМ
- SCHUTZHANDSCHUHE MIT LATEXBESCHICHTUNG

LATEX



Kat. I  
Cat. I CE

- MATERIAL: cotton; polyester; latex
- Coated with latex, improving resistance to chafing and tearing. Ended with a cuff. Called "latex-dipped" gloves.
- NORM: EN 420

Size	Code	
9 (L)	L210609W	50

12 pairs in a pack.

**4 LATEX COATED PROTECTIVE GLOVES**

- ПЕРЧАТКИ ЗАЩИТНЫЕ С ЛАТЕКСНЫМ ПОКРЫТИЕМ
- SCHUTZHANDSCHUHE MIT LATEXBESCHICHTUNG

LATEX



Kat. I  
Cat. I CE

- MATERIAL: cotton; polyester; latex
- Coated with latex on the grip part and half of the top. Porous surface ensures improved grip. Ended with a cuff.
- NORM: EN 420

Size	Code	
10 (XL)	L211410W	10

12 pairs in a pack.

**5 HOUSEHOLD LATEX PROTECTIVE GLOVES**

- ПЕРЧАТКИ ЗАЩИТНЫЕ ХОЗЯЙСТВЕННЫЕ ИЗ ЛАТЕКСА
- SCHUTZHANDSCHUHE FÜR DEN HAUSHALT AUS LATEX

FLOCK-COVERED

LATEX

NON-SLIP SURFACE

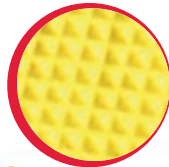

Kat. I  
Cat. I CE

- MATERIAL: latex
- Rough, non-slip surface ensures improved grip. Flock inside to facilitate glove putting on and taking off.
- NORM: EN 420

Size	Code		
8 (M)	L211008K	x	12/240
9 (L)	L211009K	x	12/240

**6 HOUSEHOLD LATEX PROTECTIVE GLOVES**

- ПЕРЧАТКИ ЗАЩИТНЫЕ ХОЗЯЙСТВЕННЫЕ ИЗ ЛАТЕКСА
- SCHUTZHANDSCHUHE FÜR DEN HAUSHALT AUS LATEX

FLOCK-COVERED

LATEX

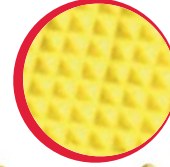

Kat. I  
Cat. I CE

- MATERIAL: latex
- Rough grip surface ensures improved grip. Flock inside to facilitate glove putting on and taking off.
- NORM: EN 420

Size	Code		
8 (M)	L211308K	x	12/240
9 (L)	L211309K	x	12/240
10 (XL)	L211310K	x	12/240

**1 PADDED GOATSKIN PROTECTIVE GLOVES**

• УТЕПЛЁННЫЕ ЗАЩИТНЫЕ ПЕРЧАТКИ ИЗ КОЗЬЕЙ КОЖИ • GEFÜTTERTER SCHUTZHANDSCHUHE AUS ZIEGENLEDER



Kat. I  
Cat. I CE

- MATERIAL: goatskin, cotton, polyester
- The contact part made from a single leather piece increases the glove durability. Fleece lining protects the user from cold and ensures higher work comfort. Stiffened cuff ensures extra wrist protection.
- NORM: EN 420

Size	Code		
10 (XL)	L250610K	x	12/120

**2 PADDED PROTECTIVE GLOVES**

• ПЕРЧАТКИ ЗАЩИТНЫЕ УТЕПЛЁННЫЕ • ISOLIERTE SCHUTZHANDSCHUHE



Kat. I  
Cat. I CE

- MATERIAL: goatskin, elastane, polyester
- Single-piece gripping part increases the durability of the glove. Top surface part of the glove made from an elastic fabric assures a perfect fit to the hand. Fleece lining protects the user against cold and increases work comfort. Elastic Velcro closed welt provides comfort.
- NORM: EN 420

Size	Code		
8 (M)	L251208K	x	12/120
9 (L)	L251209K	x	12/120
10 (XL)	L251210K	x	12/120
11 (2XL)	L251211K	x	12/120

**3 PADDED PROTECTIVE GLOVES**

• ПЕРЧАТКИ ЗАЩИТНЫЕ УТЕПЛЁННЫЕ • GEFÜTTERTER SCHUTZHANDSCHUHE



Kat. I  
Cat. I CE

- MATERIAL: polyurethane, elastane, polyester
- The contact part made from a single piece increases the glove durability. The outer surface of the glove, made from high-visibility flexible material, ensures perfect fit to the hand. A reflective component along the index finger improves the user's visibility. Fleece lining protects the user from cold and ensures higher work comfort. A wrist cuff ensures high work comfort.
- NORM: EN 420

Size	Code		
8 (M)	L250708K	x	12/120
9 (L)	L250709K	x	12/120
10 (XL)	L250710K	x	12/120
11 (2XL)	L250711K	x	12/120

**4 PADDED PROTECTIVE GLOVES**

• ПЕРЧАТКИ ЗАЩИТНЫЕ УТЕПЛЁННЫЕ • ISOLIERTE SCHUTZHANDSCHUHE



Kat. I  
Cat. I CE

- MATERIAL: polyurethane, elastane, polyester
- Single-piece gripping part increases the glove's durability. Top surface of the glove made from a high-visibility fabric also assures a perfect fit. A reflective element along the index finger increases the user's visibility. Fleece lining protects the user against cold and increases work comfort. Wrist welt provides good work comfort.
- NORM: EN 420

Size	Code		
8 (M)	L250908K	x	12/120
9 (L)	L250909K	x	12/120
10 (XL)	L250910K	x	12/120
11 (2XL)	L250911K	x	12/120

### 1 PADDED PROTECTIVE GLOVES

• ПЕРЧАТКИ ЗАЩИТНЫЕ УТЕПЛЁННЫЕ • ISOLIERTE SCHUTZHANDSCHUHE



Kat. I  
Cat. I

- MATERIAL: polyurethane, elastane, polyester
- Single-piece gripping part increases the glove's durability. Top surface part of the glove made from an elastic fabric assures a perfect fit. Fleece lining protects the user against cold and increases work comfort. A special insert between the insulation lining and the outer material limits water penetration inside the glove. A reflective element along the index finger increases the user's visibility. Elastic Velcro closed welt provides comfort.
- NORM: EN 420

Size	Code		
8 (M)	L251108K	x	12/120
9 (L)	L251109K	x	12/120
10 (XL)	L251110K	x	12/120
11 (2XL)	L251111K	x	12/120

### 2 LATEX COATED PADDED PROTECTIVE GLOVES

• ПЕРЧАТКИ ЗАЩИТНЫЕ УТЕПЛЁННЫЕ, С ЛАТЕКСНЫМ ПОКРЫТИЕМ  
• SCHUTZHANDSCHUHE MIT FÜTTERUNG UND LATEX-BESCHICHTUNG

UP TO  
**-50°C**  
PROTECTION  
AGAINST COLD

LATEX

EN 511  
010

EN 388  
2231



EXTRA  
THICK  
ACRYLIC  
PADDING



Kat. II  
Cat. II

- MATERIAL: acrylic, latex
- Coated with porous latex, improving resistance to chafing and tearing and improving grip. Protect the user from cold and improve comfort of work. Ended with a cuff.
- NORM: EN 420, EN 511, EN 388

Size	Code		
8 (M)	L250108K	x	12/120
9 (L)	L250109K	x	12/120
10 (XL)	L250110K	x	12/120
11 (2XL)	L250111K	x	12/120

### 3 LATEX COATED PADDED PROTECTIVE GLOVES

• LATEX COATED PADDED PROTECTIVE GLOVES • ПЕРЧАТКИ ЗАЩИТНЫЕ УТЕПЛЁННЫЕ, С ЛАТЕКСНЫМ ПОКРЫТИЕМ • GEFÜTTERTE SCHUTZHANDSCHUHE MIT LATEXBESCHICHTUNG

UP TO  
**-50°C**  
PROTECTION  
AGAINST COLD

HI-VIS

LATEX

EN 511  
010

EN 388  
2231



EXTRA  
THICK  
ACRYLIC  
PADDING



Kat. II  
Cat. II

- MATERIAL: acrylic, latex
- Made from higher-visibility fabric. Coated with porous latex, improving resistance to chafing and tearing and increasing grip. Protect the user from cold and improve comfort of work. Ended with a cuff.
- NORM: EN 420, EN 511, EN 388

Size	Code		
8 (M)	L250308K	x	12/120
9 (L)	L250309K	x	12/120
10 (XL)	L250310K	x	12/120
11 (2XL)	L250311K	x	12/120

### 4 LATEX COATED PADDED PROTECTIVE GLOVES

• ПЕРЧАТКИ ЗАЩИТНЫЕ УТЕПЛЁННЫЕ, С ЛАТЕКСНЫМ ПОКРЫТИЕМ • GEFÜTTERTE SCHUTZHANDSCHUHE MIT LATEXBESCHICHTUNG

UP TO  
**-50°C**  
PROTECTION  
AGAINST COLD

HI-VIS

LATEX

EN 511  
010

EN 388  
2231



EXTRA  
THICK  
ACRYLIC  
PADDING



Kat. II  
Cat. II

- MATERIAL acrylic, latex
- Made from higher-visibility fabric. Coated with porous latex, improving resistance to chafing and tearing and increasing grip. Protect the user from cold and improve comfort of work. Ended with a cuff.
- NORM: EN 420, EN 511, EN 388

Size	Code		
8 (M)	L250208K	x	12/120
9 (L)	L250209K	x	12/120
10 (XL)	L250210K	x	12/120
11 (2XL)	L250211K	x	12/120

**1 LATEX COATED PADDED PROTECTIVE GLOVES**

• ПЕРЧАТКИ ЗАЩИТНЫЕ УТЕПЛЕННЫЕ, С ЛАТЕКСНЫМ ПОКРЫТИЕМ  
• GEFÜTTERTE SCHUTZHANDSCHUHE MIT LATEXBESCHICHTUNG

HI-VIS

LATEX



ACRYLIC  
PADDING



Kat. I  
Cat. I CE

- MATERIAL: acrylic, latex
- Made from higher-visibility fabric. Coated with porous latex, improving resistance to chafing and tearing and increasing grip. Protect the user from cold and improve comfort of work. Ended with a cuff.
- NORM: EN 420

Size	Code		
8 (M)	L250408K	x	12/120
9 (L)	L250409K	x	12/120
10 (XL)	L250410K	x	12/120
11 (2XL)	L250411K	x	12/120

**2 LATEX COATED PADDED PROTECTIVE GLOVES**

• ПЕРЧАТКИ ЗАЩИТНЫЕ УТЕПЛЕННЫЕ, С ЛАТЕКСНЫМ ПОКРЫТИЕМ • LATEXBESCHICHTETE ISOLIERTE SCHUTZHANDSCHUHE

HI-VIS

LATEX



EXTRA  
THICK  
ACRYLIC  
PADDING



Kat. I  
Cat. I CE

- MATERIAL: acrylic, latex
- Made of a material that increases visibility. Coated with a porous latex that increases resistance to abrasion and tears, while also increasing adhesion. They protect the user from the cold and increase work comfort. Finished with a welt.
- NORM: EN 420

Size	Code		
8 (M)	L251008K	x	12/120
9 (L)	L251009K	x	12/120
10 (XL)	L251010K	x	12/120
11 (2XL)	L251011K	x	12/120

**3 LATEX COATED PADDED PROTECTIVE GLOVES**

• ПЕРЧАТКИ ЗАЩИТНЫЕ УТЕПЛЕННЫЕ, С ЛАТЕКСНЫМ ПОКРЫТИЕМ  
• GEFÜTTERTE SCHUTZHANDSCHUHE MIT LATEXBESCHICHTUNG

HI-VIS

LATEX



POLYESTER  
PADDING



Kat. I  
Cat. I CE

- MATERIAL: polyester, latex
- Coated with porous latex, improving resistance to chafing and tearing and increasing grip. Protect the user from cold and improve comfort of work. Ended with a cuff.
- NORM: EN 420

Size	Code		
8 (M)	L250508W		10
9 (L)	L250509W		10
10 (XL)	L250510W		10
11 (2XL)	L250511W		10

Size	Code		
9 (L)	L250509K		12/120
10 (XL)	L250510K		12/120

L250508W-L250511W 12 pairs in a pack.  
L250509K, L250510K 1 pair on a card.

**4 LATEX COATED PADDED PROTECTIVE GLOVES**

• ПЕРЧАТКИ ЗАЩИТНЫЕ УТЕПЛЕННЫЕ, С ЛАТЕКСНЫМ ПОКРЫТИЕМ • GEFÜTTERTE SCHUTZHANDSCHUHE MIT LATEXBESCHICHTUNG

HI-VIS

LATEX



POLYESTER  
PADDING



Kat. I  
Cat. I CE

- MATERIAL: polyester, latex
- Coated with porous latex, improving resistance to chafing and tearing and increasing grip. Protect the user from cold and improve comfort of work. Elastic and flexible, ensure very good grip and high comfort of work. Ended with a cuff.
- NORM: EN 420

Size	Code		
8 (M)	L250808W		10
9 (L)	L250809W		10
10 (XL)	L250810W		10
11 (2XL)	L250811W		10

Size	Code		
9 (L)	L250809K		12/120
10 (XL)	L250810K		12/120

L250808W-L250811W 12 pairs in a pack.  
L250809K, L250810K 1 pair on a card.

**1 NITRILE-COATED PROTECTIVE GLOVES WITH INCREASED RESISTANCE TO BLADE CUTTING (LEVEL 5)**

• ПЕРЧАТКИ ЗАЩИТНЫЕ ПОКРЫТЫЕ НИТРИЛОМ С ПОВЫШЕННОЙ СТОЙКОСТЬЮ К РАЗРЕЗАНИЮ ОСТРЫМИ ПРЕДМЕТАМИ (УРОВЕНЬ 5) • HANDSCHUHE MIT NITRILBESCHICHTUNG UND EINER GESTEIGERTEN BESTÄNDIGKEIT GEGEN MESSERSCHNITTE (STUFE 5)

NITRILE

EN 388

4544

LEVEL 5

BLADE CUT RESISTANCE



Kat. II  
Cat. II

- MATERIAL: HDPE, glass fibre, nylon, elastane
- Made from a mixture of fibres offering utmost protection to blade cutting (resistance level 5). The grip part of the glove is coated with nitrile, increasing resistance to grease and oils. High resistance to abrasion, tear and piercing (resistance level 4).
- NORM: EN 420, EN 388

Size	Code		
9 (L)	L200209K	x	12/120
10 (XL)	L200210K	x	12/120
11 (2XL)	L200211K	x	12/120

**2 SANDY NITRILE COATED PROTECTIVE GLOVES**

• ПЕРЧАТКИ ЗАЩИТНЫЕ ПОКРЫТЫЕ НИТРИЛОМ • HANDSCHUHE MIT NITRILBESCHICHTUNG

NITRILE

EN 388

4122



Kat. II  
Cat. II

- MATERIAL: polyamide, polyester, nitrile
- The grip part of the glove is coated with nitrile, increasing improved resistance to grease and oils. Nitrile coating with a special texture increases comfort of work with slippery objects. Elastic and stretchy, fit the hand shape perfectly. Ended with a cuff.
- NORM: EN 420, EN 388

Size	Code		
8 (M)	L220608K	x	12/120
9 (L)	L220609K	x	12/120
10 (XL)	L220610K	x	12/120
11 (2XL)	L220611K	x	12/120

**3 NITRILE COATED PROTECTIVE GLOVES**

• ПЕРЧАТКИ ЗАЩИТНЫЕ ПОКРЫТЫЕ НИТРИЛОМ • NITRILBESCHICHTETE SCHUTZHANDSCHUHE

NITRILE



Kat. I  
Cat. I

- MATERIAL: nylon, elastane, nitrile.
- Nitrile coating on the gripping part and half of the upper. Foamed nitrile coating provides high breathability. Increased resistance to greases and oils. Flexible and stretchable, they match the shape of the hand perfectly. Finished with a welt
- NORM: EN 420

Size	Code		
7 (S)	L221207K	x	12/120
8 (M)	L221208K	x	12/120
9 (L)	L221209K	x	12/120
10 (XL)	L221210K	x	12/120
11 (2XL)	L221211K	x	12/120

**4 NITRILE COATED PROTECTIVE GLOVES**

• ПЕРЧАТКИ ЗАЩИТНЫЕ ПОКРЫТЫЕ НИТРИЛОМ • NITRILBESCHICHTETE SCHUTZHANDSCHUHE

NITRILE



Kat. I  
Cat. I

- MATERIAL: nylon, elastane, nitrile
- Nitrile coating on the gripping part and half of the upper. Thin, foamed nitrile coating provides high breathability, good dexterity and a perfect feel for the held object. Increased resistance to greases and oils. Flexible and stretchable, they match the shape of the hand perfectly. Finished with a welt
- NORM: EN 420

Size	Code		
7 (S)	L221307K	x	12/120
8 (M)	L221308K	x	12/120
9 (L)	L221309K	x	12/120
10 (XL)	L221310K	x	12/120
11 (2XL)	L221311K	x	12/120

**1 NITRILE COATED PROTECTIVE GLOVES**

• ПЕРЧАТКИ ЗАЩИТНЫЕ ПОКРЫТЫЕ НИТРИЛОМ • NITRILBESCHICHTETE SCHUTZHANDSCHUHE

NITRILE



Kat. I  
Cat. I CE

- MATERIAL: nylon, elastane, nitrile
- Nitrile coating on the gripping part and half of the upper. Additional sprinkling of nitrile on the gripping part increases work comfort with slippery objects. Upper surface of the glove made from a high-visibility fabric. Foamed nitrile coating provides high breathability. Increased resistance to greases and oils. Flexible and stretchable, they match the shape of the hand perfectly. Finished with a welt.
- NORM: EN 420

Size	Code		
7 (S)	L221407K	x	12/ 120
8 (M)	L221408K	x	12/ 120
9 (L)	L221409K	x	12/ 120
10 (XL)	L221410K	x	12/ 120
11 (2XL)	L221411K	x	12/ 120



**2 NITRILE COATED PROTECTIVE GLOVES**

• ПЕРЧАТКИ ЗАЩИТНЫЕ ПОКРЫТЫЕ НИТРИЛОМ  
• HANDSCHUHE MIT NITRILBESCHICHTUNG

NITRILE

EN 388  
4121



Kat. II  
Cat. II CE

- MATERIAL: nylon, nitrile
- Coated with double nitrile layer on the contact surface and half of the outer part. Nitrile coating with a special texture increases comfort of work with slippery objects. High abrasion resistance (resistance level 4). Improved resistance to grease and oil. Finished with a cuff.
- NORM: EN 420, EN 388

Size	Code		
8 (M)	L221008K	x	12/ 120
9 (L)	L221009K	x	12/ 120
10 (XL)	L221010K	x	12/ 120
11 (2XL)	L221011K	x	12/ 120

**3 NITRILE COATED PROTECTIVE GLOVES**

• ПЕРЧАТКИ ЗАЩИТНЫЕ ПОКРЫТЫЕ НИТРИЛОМ  
• SCHUTZHANDSCHUHE MIT NITRILBESCHICHTUNG

NITRILE



Kat. I  
Cat. I CE

- MATERIAL: polyester, nitrile
- Coated with nitrile on the grip and top part, to ensure higher resistance to grease and oil. Elastic and stretchy, fit the hand perfectly. Ended with a cuff.
- NORM: EN 420

Size	Code		
8 (M)	L220708W	10	
9 (L)	L220709W	10	
10 (XL)	L220710W	10	
11 (2XL)	L220711W	10	

12 pairs in a pack.

**4 NITRILE COATED PROTECTIVE GLOVES**

• ПЕРЧАТКИ ЗАЩИТНЫЕ ПОКРЫТЫЕ НИТРИЛОМ  
• SCHUTZHANDSCHUHE MIT NITRILBESCHICHTUNG

NITRILE



Kat. I  
Cat. I CE

- MATERIAL: polyester, nitrile
- Coated with nitrile on the contact surface and half of the outer part. Improved resistance to grease and oil. Finished with a cuff.
- NORM: EN 420

Size	Code		
8 (M)	L221108W	10	
9 (L)	L221109W	10	
10 (XL)	L221110W	10	
11 (2XL)	L221111W	10	

12 pairs in a pack.

**1 NITRILE COATED PROTECTIVE GLOVES**

- ПЕРЧАТКИ ЗАЩИТНЫЕ ПОКРЫТЫЕ НИТРИЛОМ
- HANDSCHUHE MIT NITRILBESCHICHTUNG

NITRILE



Kat. I  
Cat. I CE

- MATERIAL: polyester, nitrile
- Coated with nitrile, ensuring higher resistance to grease and oil. Elastic and stretchy, fit the hand perfectly. Ended with a cuff.
- NORM: EN 420

Size	Code	
7 (S)	L220307W	20
8 (M)	L220308W	20
9 (L)	L220309W	20
10 (XL)	L220310W	20
11 (2XL)	L220311W	20

Size	Code	
9 (L)	L220309K	12/240
10 (XL)	L220310K	12/240

L220307W-L220311W 12 pairs in a pack.  
L220309K, L220310K 1 pair on a card.

**2 NITRILE COATED PROTECTIVE GLOVES**

- ПЕРЧАТКИ ЗАЩИТНЫЕ ПОКРЫТЫЕ НИТРИЛОМ
- SCHUTZHANDSCHUHE MIT NITRILBESCHICHTUNG

NITRILE

EN 388  
4111



Kat. II  
Cat. II CE

- MATERIAL: cotton, nitrile
- Coated with nitrile on the grip surface and half of the top. High resistance to chafing (resistance level 4). Improved resistance to grease and oil.
- NORM: EN 420, EN 388

Size	Code	
9 (L)	L220209W	20
10 (XL)	L220210W	20

12 pairs in a pack.

**3 NITRILE COATED PROTECTIVE GLOVES**

- ПЕРЧАТКИ ЗАЩИТНЫЕ ПОКРЫТЫЕ НИТРИЛОМ
- SCHUTZHANDSCHUHE MIT NITRILBESCHICHTUNG

NITRILE



Kat. I  
Cat. I CE

- MATERIAL: cotton, nitrile
- Coated with nitrile on the grip surface and half of the top. Improved resistance to grease and oil.
- NORM: EN 420

Size	Code	
8 (M)	L220108W	20
9 (L)	L220109W	20
10 (XL)	L220110W	20

12 pairs in a pack.

**4 NITRILE COATED PROTECTIVE GLOVES**

- ПЕРЧАТКИ ЗАЩИТНЫЕ ПОКРЫТЫЕ НИТРИЛОМ
- HANDSCHUHE MIT NITRILBESCHICHTUNG

NITRILE

EN 388  
4121x



Kat. II  
Cat. II CE

- MATERIAL: cotton, polyester, nitrile
- Coated with nitrile on the grip and top part. Stiffened cuff. High resistance to chafing (resistance level 4). Improved resistance to grease and oil.
- NORM: EN 420, EN 388

Size	Code	
10 (XL)	L220510W	10

Size	Code	
10 (XL)	L220510K	12/120

L220510W 12 pairs in a pack.  
L220510K 1 pair on a card.

**5 NITRILE COATED PROTECTIVE GLOVES**

- ПЕРЧАТКИ ЗАЩИТНЫЕ ПОКРЫТЫЕ НИТРИЛОМ
- SCHUTZHANDSCHUHE MIT NITRILBESCHICHTUNG

NITRILE



Kat. I  
Cat. I CE

- MATERIAL: cotton, nitrile
- Coated with nitrile on the grip part and top, to ensure improved resistance to grease and oil.
- NORM: EN 420

Size	Code	
10 (XL)	L220910W	10

12 pairs in a pack.



**1 NITRILE COATED PROTECTIVE GLOVES**

• ПЕРЧАТКИ ЗАЩИТНЫЕ ПОКРЫТЫЕ НИТРИЛОМ • HANDSCHUHE MIT NITRILBESCHICHTUNG

**NITRILE**



**Kat. I  
Cat. I** CE

- MATERIAL: polyester, nitrile
- Coated with nitrile along the entire grip part and on the finger tips outside, to ensure improved resistance to grease and oil. Elastic and stretchy, fit the hand perfectly. Ended with a cuff.
- NORM: EN 420

Size	Code		
7 (S)	L220407K	x	12/120
8 (M)	L220408K	x	12/120
9 (L)	L220409K	x	12/120

**2 PROTECTIVE GLOVES MADE FROM NITRILE, DISPOSABLE**

• ПЕРЧАТКИ ЗАЩИТНЫЕ ОДНОРАЗОВЫЕ ИЗ НИТРИЛА  
• SCHUTZHANDSCHUHE EINWEGPRODUKTE AUS NITRIL

**NITRILE**



**Kat. I  
Cat. I** CE

- MATERIAL: nitrile
- Made from nitrile, ensuring higher resistance to grease and oil. Elastic and stretchy, fit the hand perfectly. Porous pattern on fingertips improves the comfort of work with slippery objects.
- NORM: EN 420

Size	Code	
7 (S)	L220807B	10
8 (M)	L220808B	10
9 (L)	L220809B	10
10 (XL)	L220810B	10

100 szt. in package.

**3 POLYURETHANE-COATED PROTECTIVE GLOVES WITH INCREASED RESISTANCE TO BLADE CUTTING (LEVEL 5)**

• ПЕРЧАТКИ ЗАЩИТНЫЕ С ПОЛИУРЕТАНОВЫМ ПОКРЫТИЕМ С ПОВЫШЕННОЙ СТОЙКОСТЬЮ К РАЗРЕЗАНИЮ ОСТРЫМИ ПРЕДМЕТАМИ (УРОВЕНЬ 5) • HANDSCHUHE MIT POLYURETHANBESCHICHTUNG UND GESTEIGERTE BESTÄNDIGKEIT GEGEN MESSERSCHNITTE (STUFE 5)

**PU**

**EN 388**  
4543

**LEVEL 5**  
BLADE CUT RESISTANCE



**Kat. II  
Cat. II** CE

- MATERIAL: modified synthetic fibre, polyester, polyurethane
- PU-coating ensures high manual dexterity and perfect feel of the object held. High resistance to chafing (resistance level 4). Made from modified synthetic fibre with the highest resistance to blade cutting (resistance level 5). Ended with a cuff.
- NORM: EN 420, EN 388

Size	Code		
10 (XL)	L200110K	x	12/240

**4 ANTISTATIC PROTECTIVE GLOVES**

• ПЕРЧАТКИ ЗАЩИТНЫЕ АНТИЭЛЕКТРОСТАТИЧЕСКИЕ • ANTISTATISCHE SCHUTZHANDSCHUHE

**ANTI-STATIC**

**PU**  
**EN 388**  
4131x



**Kat. II  
Cat. II** CE

- MATERIAL: nylon, carbon fibre, polyurethane
- Coated with polyurethane to ensure high manual dexterity and perfect feel of the object held. Carbon fibre prevents accumulation of static charge on the glove surface. Elastic and stretchy, fit the hand perfectly. High resistance to static charge (can be used in explosive atmosphere). Ended with a cuff. Wide scope of application (e.g. precision works, works related to installing electronic components, works in explosive atmosphere).

IMPORTANT: To ensure comprehensive static discharge protection, the gloves should be worn with protective clothes, shoes and headgear carefully selected and made from proven anti-static fabric.

- NORM: EN 420, EN 388, EN 16350:2014

Size	Code		
7 (S)	L230407K	x	12/120
8 (M)	L230408K	x	12/120
9 (L)	L230409K	x	12/120
10 (XL)	L230410K	x	12/120
11 (2XL)	L230411K	x	12/120

PROLINE

LAHTI PRO

MEGA

JUCO

OTHER BRANDS

ERDI

KLINGSPOR

EXPRESS

ACTION CAN

TRAYTON

VULCAN

**1 PU COATED PROTECTIVE GLOVES**

- ПЕРЧАТКИ ЗАЩИТНЫЕ С ПОЛИУРЕТАНОВЫМ ПОКРЫТИЕМ
- SCHUTZHANDSCHUHE MIT POLYURETHANBESCHICHTUNG



**Kat. I**  
**Cat. I** CE

- MATERIAL: polyester; polyurethane
- Coated with polyurethane, ensuring high manual dexterity and perfect feel of the object held. Elastic and stretchy, fit the hand perfectly. Ended with a cuff.
- NORM: EN 420

Size	Code		
7 (S)	L230107W		25
8 (M)	L230108W		25
9 (L)	L230109W		25
10 (XL)	L230110W		25
11 (2XL)	L230111W		25

Size	Code		
9 (L)	L230109K		12/300
10 (XL)	L230110K		12/300

L230107W-L230111W 12 pairs in a pack.  
L230109K, L230110K 1 pair on a card.

**2 PU COATED PROTECTIVE GLOVES**

- ПЕРЧАТКИ ЗАЩИТНЫЕ С ПОЛИУРЕТАНОВЫМ ПОКРЫТИЕМ
- SCHUTZHANDSCHUHE MIT POLYURETHANBESCHICHTUNG



**Kat. I**  
**Cat. I** CE

- MATERIAL: polyester; polyurethane
- Coated with polyurethane, ensuring high manual dexterity and perfect feel of the object held. Elastic and stretchy, fit the hand perfectly. Ended with a cuff.
- NORM: EN 420

Size	Code		
7 (S)	L230207W		25
8 (M)	L230208W		25
9 (L)	L230209W		25
10 (XL)	L230210W		25
11 (2XL)	L230211W		25

Size	Code		
9 (L)	L230209K		12/300
10 (XL)	L230210K		12/300

L230207W-L230211W 12 pairs in a pack.  
L230209K, L230210K 1 pair on a card.

**3 PU COATED PROTECTIVE GLOVES**

- ПЕРЧАТКИ ЗАЩИТНЫЕ С ПОЛИУРЕТАНОВЫМ ПОКРЫТИЕМ
- HANDSCHUHE MIT POLYURETHANBESCHICHTUNG



**Kat. II**  
**Cat. II** CE

- MATERIAL: polyester; polyurethane
- Coated with polyurethane, ensuring high manual abilities and perfect feel of the object kept in hand. High abrasion resistance (resistance level 4). Elastic and stretchy, fit the hand perfectly. Finished with a cuff.
- NORM: EN 420, EN 388

Size	Code		
8 (M)	L230507W		10
9 (L)	L230508W		10
10 (XL)	L230509W		10
11 (2XL)	L230510W		10

12 pairs in a pack.

**4 PU COATED PROTECTIVE GLOVES**

- ПЕРЧАТКИ ЗАЩИТНЫЕ С ПОЛИУРЕТАНОВЫМ ПОКРЫТИЕМ
- HANDSCHUHE MIT POLYURETHANBESCHICHTUNG



**Kat. I**  
**Cat. I** CE

- MATERIAL: polyester; polyurethane
- Coated with polyurethane along the entire grip part and on the finger tips outside, to ensure improved manual dexterity and perfect feel of the object held. Elastic and stretchy, fit the hand perfectly. Ended with a cuff.
- NORM: EN 420

Size	Code		
7 (S)	L230307K	x	12/240
8 (M)	L230308K	x	12/240
9 (L)	L230309K	x	12/240

**5 PVC COATED PROTECTIVE GLOVES**

- ПЕРЧАТКИ ЗАЩИТНЫЕ С ПВХ ПОКРЫТИЕМ
- SCHUTZHANDSCHUHE MIT PVC-ÜBERGUSS



**Kat. II**  
**Cat. II** CE

- MATERIAL: cotton, PVC
- PVC-coated on the top and palm. High resistance to chafing (resistance level 4). Improved resistance to grease and oil.
- NORM: EN 420, EN 388

Size	Code		
9 (L)	L240109W		10
10 (XL)	L240110W		10

Size	Code		
10 (XL)	L240110K		12/120

L240109W, L240110W 12 pairs in a pack.  
L240110K 1 pair on a card.

**6 PVC PROTECTIVE GLOVES**

- ПЕРЧАТКИ ЗАЩИТНЫЕ ИЗ ПВХ • SCHUTZHANDSCHUHE AUS PVC



**Kat. II**  
**Cat. II** CE

- MATERIAL: cotton, PVC
- Coated with PVC in whole, to ensure improved resistance to grease and oil.
- NORM: EN 420, EN 388

Size	Code		
10 (XL)	L240210W		10

12 pairs in a pack.

**1 DOTTED PROTECTIVE GLOVES**

• ПЕРЧАТКИ ЗАЩИТНЫЕ С ТОЧЕЧНЫМ ПОКРЫТИЕМ • GERPUNKTETE SCHUTZHANDSCHUHE

PVC



Kat. I  
Cat. I



- MATERIAL: cotton, PVC.
- PVC spots assure a non-slip effect and excellent grip. Finished with a welt.
- NORM: EN 420

Size	Code		
7 (S)	L240507K	x	12/120
8 (M)	L240508K	x	12/120
9 (L)	L240509K	x	12/120



**2 DOTTED PROTECTIVE GLOVES**

• ПЕРЧАТКИ ЗАЩИТНЫЕ С ТОЧЕЧНЫМ ПОКРЫТИЕМ • GERPUNKTETE SCHUTZHANDSCHUHE

PVC



Kat. I  
Cat. I



- MATERIAL: cotton, PVC
- PVC dots offer non-slip properties and excellent grip. Finished with a cuff.
- NORM: EN 420

Size	Code	
10 (XL)	L240310W	25

12 pairs in a pack.

**3 DOTTED PROTECTIVE GLOVES**

• ПЕРЧАТКИ ЗАЩИТНЫЕ С ТОЧЕЧНЫМ ПОКРЫТИЕМ • GERPUNKTETE SCHUTZHANDSCHUHE

PVC



Kat. I  
Cat. I



- MATERIAL: cotton, polyester
- PVC spots provide a non-slip effect and excellent grip
- NORM: EN 420

Size	Code	
10 (XL)	L240410W	10

12 pairs in a pack.

## LEG PROTECTION

- ankle boots
- clogs
- insoles
- knee pads
- wellingtons
- sandals
- shoe laces
- shoes
- snow boots



**1 SANDALS (SAFETY FOOTWEAR)**

• САНДАЛИ (БЕЗОПАСНАЯ ОБУВЬ) • SANDALEN (SICHERHEITSSCHUHE)

- S1 SRA
- 
- METAL FREE
- RUBBER



- MATERIAL: Upper: suede / knitwear mesh, outer shoe front and back strengthened with TPR. Lining: knitwear mesh. Insole: replaceable. Sole: non-slip rubber (on ceramic surface), resistant to diesel oil, a deep tread ensures high footwear stability.
- SAFETY CAT.: S1 SRA
- The sandals have a composite toe cap, antistatic properties and a covered heel. They also absorb energy in the heel part. The shoes do not have any metal components.
- NORM: ISO 20345:2011

L30603XX XX: 39, 40, 41, 42, 43, 44, 45, 46, 47  10

**2 SANDALS WITH NO TOE CAP (OCCUPATIONAL FOOTWEAR)**

• САНДАЛИ БЕЗ УСИЛЕННОГО НОСКА (ПРОФЕССИОНАЛЬНАЯ ОБУВЬ) • SANDALEN OHNE KAPPEN (BERUFSSCHUHE)

- O1 SRA
- 
- METAL FREE
- NO TOE CAP
- RUBBER



- MATERIAL: Upper: suede / knitwear mesh, outer shoe front and back strengthened with TPR. Lining: knitwear mesh. Insole: replaceable. Sole: non-slip rubber (on ceramic surface), a deep tread ensures high footwear stability.
- SAFETY CAT.: S1 SRA
- The sandals have antistatic properties and a covered heelcap. They also absorb energy in the heel part. The shoes do not have any metal components.
- NORM: ISO 20347: 2011

L30606XX XX: 39, 40, 41, 42, 43, 44, 45, 46, 47  10

**3 LADIES SANDALS (SAFETY FOOTWEAR)**

• САНДАЛИИ ЖЕНСКИЕ (БЕЗОПАСНАЯ ОБУВЬ) • DAMENSANDALEN (SICHERHEITSSCHUHE)

- S1 SRC
- 
- METAL FREE
- RUBBER



- MATERIAL: Upper: suede / knitwear mesh, outer shoe front and back strengthened with TPR. Lining: knitwear mesh. Insole: replaceable. Sole: non-slip rubber (on ceramic and steel surface), resistant to diesel oil.
- SAFETY CAT.: S1 SRC
- The sandals have a composite toe cap, antistatic properties, reflective elements and a covered heel. They also absorb energy in the heel part. The shoes do not have any metal components.
- NORM: ISO 20345:2011

L30604XX XX: 36, 37, 38, 39, 40, 41, 42  10



PROLINE

LAHTI PRO

MEGA

JUDO

OTHER BRANDS

ENDI

KLINGSPOR

EXPRESS

ACTION CAN

TRAYTON

VULCAN

PROLINE

LAHTI PRO

MEGA

JUCO

OTHER BRANDS

ERDI

KLINGSPOR

EXPRESS

ACTION CAN

TRAYTON

VULCAN

**1 SANDALS (SAFETY FOOTWEAR)**  
 • САНДАЛИ (БЕЗОПАСНАЯ ОБУВЬ) • SANDALEN (SICHERHEITSSCHUHE)

S1 SRC



- MATERIAL: Upper: suede. Lining: knitwear mesh. Insole: replaceable. Sole: non-slip two-thickness polyurethane (on steel and ceramic surfaces), resistant to diesel oil, a deep tread ensures high footwear stability.
- SAFETY CAT.: S1 SRC
- The sandals have a steel toe cap and display antistatic properties. They absorb energy in their heel part. They possess also a covered heel and reflective elements.
- NORM: ISO 20345: 2011

L30601XX XX: 39, 40, 41, 42, 43, 44, 45, 46, 47 10

**2 SANDALS (SAFETY FOOTWEAR)**  
 • САНДАЛИ (БЕЗОПАСНАЯ ОБУВЬ) • SANDALEN (SICHERHEITSSCHUHE)

S1 SRC



- MATERIAL: Upper: leather. Lining: knitwear mesh. Insole: replaceable. Sole: non-slip two-thickness polyurethane (on steel and ceramic surfaces), resistant to diesel oil, a deep tread ensures high footwear stability.
- SAFETY CAT.: S1 SRC
- The sandals have a steel toe cap and display antistatic properties. They absorb energy in their heel part. They possess also a covered heel and reflective elements.
- NORM: ISO 20345: 2011

LPSOMAXX XX: 39, 40, 41, 42, 43, 44, 45, 46, 47 10

**3 SANDALS WITH NO TOE CAP (OCCUPATIONAL FOOTWEAR)**  
 • САНДАЛИ БЕЗ УСИЛЕННОГО НОСКА (ПРОФЕССИОНАЛЬНАЯ ОБУВЬ) • SANDALEN OHNE KAPPEN (BERUFSSCHUHE)

O1 SRC



METAL FREE



- MATERIAL: Upper: leather. Lining: knitwear mesh. Insole: replaceable. Sole: non-slip two-thickness polyurethane (on steel and ceramic surfaces), a deep tread ensures high footwear stability.
- SAFETY CAT.: O1 SRC
- The sandals have antistatic properties and a covered heel. They also absorb energy in the heel part. The shoes do not have any metal components.
- NORM: ISO 20347:2011

L30602XX XX: 39, 40, 41, 42, 43, 44, 45, 46, 47 10

**4 LADIES SANDALS (SAFETY FOOTWEAR)**  
 • САНДАЛИ ЖЕНСКИЕ (БЕЗОПАСНАЯ ОБУВЬ) • DAMENSANDALEN (SICHERHEITSSCHUHE)

S1 SRC



- MATERIAL: Upper: leather. Lining: knitwear mesh. Insole: replaceable. Sole: non-slip two-thickness polyurethane (steel and ceramic surface), resistant to diesel oil, a deep tread and parabolic heel which ensure high footwear stability and comfort of walking.
- SAFETY CAT.: S1 SRC
- The sandals have a steel toe cap, covered heelcap and antistatic properties. They absorb energy in their heel part.
- NORM: ISO 20345:2011

L30605XX XX: 36, 37, 38, 39, 40, 41, 42 10

**1 SHOES WITH NO TOE CAP (OCCUPATIONAL FOOTWEAR)**

• ПОЛУБОТИНКИ БЕЗ ПОДНОСКА (ОБУВЬ ДЛЯ ПРОФЕССИОНАЛЬНОГО ИСПОЛЬЗОВАНИЯ)  
• HALBSCHUHE OHNE KAPPE (BERUFSSCHUHE)

O2  
SRA

HIGH QUALITY  
CRAZY HORSE  
LEATHER

LEATHER INSOLE  
LEATHER LINING

NO TOE CAP

RUBBER



- MATERIAL: Upper: high-quality full-grain trekking „crazy horse” leather, outer boot front and back strengthened with TPR, high-quality metal eyelets. Lining: leather. Insole: replaceable leather. Sole: non-slip rubber (ceramic surface), a deep tread ensures high footwear stability.
- SAFETY CAT.: O2 SRA
- The low-cut shoes offer the following features: anti-electrostatic properties, energy absorption in the heel area, a covered heel, and limited permeability and water absorption.
- NORM: ISO 20347:2011

L30415XX XX: 39, 40, 41, 42, 43, 44, 45, 46, 47 10

**3 SHOES (SAFETY FOOTWEAR)**

• ПОЛУБОТИНКИ (БЕЗОПАСНАЯ ОБУВЬ) • HALBSCHUHE (SICHERHEITSSCHUHE)

SB  
SRA

HIGH QUALITY  
CRAZY HORSE  
LEATHER

RUBBER



- MATERIAL: Upper: leather / Oxford knitwear, outer shoe back strengthened with TPR. Lining: knitwear mesh. Insole: replaceable. Sole: non-slip rubber (on ceramic surface), a deep tread ensures high footwear stability.
- SAFETY CAT.: SB SRA
- The shoes have a steel toe cap.
- NORM: ISO 20345:2011

L30402XX XX: 36, 37, 38, 39, 40, 41, 42, 43, 44, 45, 46, 47 10

**2 SHOES (SAFETY FOOTWEAR)**

• ПОЛУБОТИНКИ (БЕЗОПАСНАЯ ОБУВЬ) • HALBSCHUHE (SICHERHEITSSCHUHE)

S1P  
SRA

HIGH QUALITY  
CRAZY HORSE  
LEATHER

METAL  
FREE

RUBBER



- MATERIAL: Upper: nubuck / knitwear mesh, outer shoe side strengthened with TPR. Lining: knitwear mesh. Insole: replaceable. Sole: non-slip rubber (on ceramic surface), resistant to diesel oil, a deep tread ensures high footwear stability.
- SAFETY CAT.: S1P SRA
- The shoes have a composite toe cap, polymer anti-puncture insert, antistatic properties and covered heel. They also absorb energy in the heel part. The shoes do not have any metal components.
- NORM: ISO 20345:2011

L30403XX XX: 39, 40, 41, 42, 43, 44, 45, 46, 47 10

**4 SHOES WITH NO TOE CAP (OCCUPATIONAL FOOTWEAR)**

• ПОЛУБОТИНКИ БЕЗ ПОДНОСКА (ОБУВЬ ДЛЯ ПРОФЕССИОНАЛЬНОГО ИСПОЛЬЗОВАНИЯ) • HALBSCHUHE OHNE KAPPEN (BERUFSSCHUHE)

O1  
SRA

HIGH QUALITY  
CRAZY HORSE  
LEATHER

METAL  
FREE

NO TOE CAP

RUBBER



- MATERIAL: Upper: nubuck / knitwear mesh, outer shoe side strengthened with TPR. Lining: knitwear mesh. Insole: replaceable. Sole: non-slip rubber (on ceramic surface), a deep tread ensures high footwear stability.
- SAFETY CAT.: O1 SRA
- The shoes have antistatic properties and a covered heel. They also absorb energy in the heel part. The shoes do not have any metal components.
- NORM: ISO 20347:2011

L30409XX XX: 39, 40, 41, 42, 43, 44, 45, 46, 47 10

PROLINE

LAHTI PRO

MEGA

JUGO

OTHER BRANDS

ERDI

KLINGSPOR

EXPRESS

ACTION CAN

TRAYTON

VULCAN

### 1 SHOES WITH NO TOE CAP (OCCUPATIONAL FOOTWEAR)

• ПОЛУБОТИНКИ БЕЗ ПОДНОСКА (ОБУВЬ ДЛЯ ПРОФЕССИОНАЛЬНОГО ИСПОЛЬЗОВАНИЯ)  
• HALBSCHUHE OHNE KAPPEN (BERUFSSCHUHE)

OB FO  
SRA



METAL  
FREE



- MATERIAL: Upper: suede / Oxford knitwear; outer shoe back strengthened with TPR. Lining: knitwear mesh. Insole: replaceable. Sole: non-slip rubber (on ceramic surface), resistant to diesel oil, a deep tread ensures high footwear stability.
- SAFETY CAT.: OB FO SRA
- The shoes do not have any metal components.
- NORM: ISO 20347:2011

L30408XX XX: 39, 40, 41, 42, 43, 44, 45, 46, 47  10

### 2 SHOES (SAFETY FOOTWEAR)

• ПОЛУБОТИНКИ (БЕЗОПАСНАЯ ОБУВЬ) • HALBSCHUHE (SICHERHEITSSCHUHE)

S1P  
SRA



- MATERIAL: Upper: suede, outer shoe front and back strengthened with TPR, high-quality metal eyelets. Lining: knitwear mesh. Insole: replaceable. Sole: non-slip rubber (on ceramic surface), resistant to diesel oil, a deep tread ensures high footwear stability.
- SAFETY CAT.: S1P SRA
- The shoes have a steel toe cap, steel anti-puncture insert, antistatic properties and covered heel. They also absorb energy in the heel part.
- NORM: ISO 20345:2011

L30410XX XX: 39, 40, 41, 42, 43, 44, 45, 46, 47  10

### 3 SHOES (SAFETY FOOTWEAR)

• ПОЛУБОТИНКИ (БЕЗОПАСНАЯ ОБУВЬ) • HALBSCHUHE (SICHERHEITSSCHUHE)

SB FO  
SRA



- MATERIAL: Upper: suede. Lining: knitwear mesh. Insole: replaceable. Sole: non-slip rubber (on ceramic surface), resistant to diesel oil.
- SAFETY CAT.: SB FO SRA
- The shoes have a steel toe cap.
- NORM: ISO 20345:2011

L30407XX XX: 39, 40, 41, 42, 43, 44, 45, 46, 47  10

### 4 LADIES' SHOES (SAFETY FOOTWEAR)

• ПОЛУБОТИНКИ ЖЕНСКИЕ (БЕЗОПАСНАЯ ОБУВЬ) • DAMENHALBSCHUHE (SICHERHEITSSCHUHE)

S1  
SRA



- MATERIAL: Upper: suede / knitwear mesh. Lining: knitwear mesh. Insole: replaceable. Sole: non-slip rubber (on ceramic surface), resistant to diesel oil, a deep tread ensures high footwear stability.
- SAFETY CAT.: S1 SRA
- The shoes have a steel toe cap and antistatic properties. They absorb energy in their heel part. They possess also a covered heel and reflective elements.
- NORM: ISO 20345:2011

L30406XX XX: 36, 37, 38, 39, 40, 41, 42  10



**1 LADIES' SHOES WITH NO TOE CAP (OCCUPATIONAL FOOTWEAR)**

- ПОЛУБОТИНКИ ЖЕНСКИЕ БЕЗ ПОДНОСКА (ОБУВЬ ДЛЯ ПРОФЕССИОНАЛЬНОГО ИСПОЛЬЗОВАНИЯ)
- DAMENHALBSCHUHE OHNE KAPPEN (BERUFSSCHUHE)



O1 SRC

METAL FREE

NO TOE CAP

RUBBER



Kat. II Cat. II CE

- MATERIAL: Upper: suede / knitwear mesh. Lining: knitwear mesh. Insole: replaceable. Sole: non-slip rubber (on steel and ceramic surfaces).
- SAFETY CAT.: O1 SRC
- The shoes have antistatic properties and a covered heel. They also absorb energy in the heel part. The shoes do not have any metal components.
- NORM: ISO 20347:2011

L30411XX XX: 36, 37, 38, 39, 40, 41, 42 10

**2 SHOES (SAFETY FOOTWEAR)**

- ПОЛУБОТИНКИ (БЕЗОПАСНАЯ ОБУВЬ) • HALBSCHUHE (SICHERHEITSSCHUHE)



S3 SRC



S SRC PU/PU Kat. II Cat. II CE

- MATERIAL: Upper: nubuck. Lining: knitwear mesh. Insole: replaceable. Sole: non-slip two-thickness polyurethane (steel and ceramic surface), resistant to diesel oil, a deep tread and parabolic heel which ensure high footwear stability and comfort of walking.
- SAFETY CAT.: S3 SRC
- The low-cut shoes offer the following features: a steel toe cap, polymer insole, anti-electrostatic properties, energy absorption in the heel area, enclosed heel, limited permeability and water absorption.
- NORM: ISO 20345: 2011

L30414XX XX: 39, 40, 41, 42, 43, 44, 45, 46, 47 10

**3 SHOES (SAFETY FOOTWEAR)**

- ПОЛУБОТИНКИ (БЕЗОПАСНАЯ ОБУВЬ) • HALBSCHUHE (SICHERHEITSSCHUHE)



S1P SRA



S SRA PU/PU Kat. II Cat. II CE

- MATERIAL: Upper: suede / knitwear mesh. Lining: knitwear mesh. Insole: replaceable. Sole: non-slip two-thickness polyurethane (on ceramic surface), resistant to diesel oil, a deep tread ensures high footwear stability.
- SAFETY CAT.: S1P SRA
- The shoes have a steel toe cap, steel anti-puncture insert, antistatic properties and covered heel. They also absorb energy in the heel part.
- NORM: ISO 20345:2011

L30405XX XX: 39, 40, 41, 42, 43, 44, 45, 46, 47 10

**4 SHOES (SAFETY FOOTWEAR)**

- ПОЛУБОТИНКИ (БЕЗОПАСНАЯ ОБУВЬ) • HALBSCHUHE (SICHERHEITSSCHUHE)



S1P SRC



S SRC PU/PU Kat. II Cat. II CE

- MATERIAL: Upper: suede/ knitwear mesh, high-quality metal eyelets. Lining: knitwear mesh. Insole: replaceable. Sole: non-slip two-thickness polyurethane (on steel and ceramic surfaces), resistant to diesel oil, a deep tread ensures high footwear stability.
- SAFETY CAT.: S1P SRC
- The shoes have a steel toe cap, steel anti-puncture insert, antistatic properties and covered heel. They also absorb energy in the heel part.
- NORM: ISO 20345:2011

L30404XX XX: 39, 40, 41, 42, 43, 44, 45, 46, 47 10

PROLINE  
LAHTI PRO  
MEGA  
JUCO  
OTHER BRANDS  
ERDI  
KLINGSPOR  
EXPRESS  
ACTION CAN  
TRYTON  
VULCAN

**1 SHOES (SAFETY FOOTWEAR)**

• ПОЛУБОТИНКИ (БЕЗОПАСНАЯ ОБУВЬ) • HALBSCHUHE (SICHERHEITSSCHUHE)

**S1  
SRA**



**METAL  
FREE**



- MATERIAL: Upper: leather. Lining: knitwear mesh. Insole: replaceable. Sole: non-slip two-thickness polyurethane (on ceramic surface), resistant to diesel oil, a deep tread and parabolic heel which ensure high footwear stability and comfort of walking.
- SAFETY CAT.: S1 SRA
- The shoes have a composite toe cap, antistatic properties and a covered heel. They also absorb energy in the heel part. The shoes do not have any metal components.
- NORM: ISO 20345:2011

LPPOMBXX XX: 39, 40, 41, 42, 43, 44, 45, 46, 47 10

**2 SHOES (SAFETY FOOTWEAR)**

• ПОЛУБОТИНКИ (БЕЗОПАСНАЯ ОБУВЬ) • HALBSCHUHE (SICHERHEITSSCHUHE)

**S3  
SRC**



- MATERIAL: Upper: leather. Lining: knitwear mesh. Insole: replaceable. Sole: non-slip one-thickness polyurethane (on ceramic surface), resistant to diesel oil, a deep tread and parabolic heel which ensure high footwear stability and comfort of walking.
- SAFETY CAT.: S3 SRC
- The shoes have a steel toe cap and steel anti-puncture insert, and antistatic properties. They absorb energy in their heel part. They possess also a covered heel, limited water permeability and absorption, and reflective elements.
- NORM: ISO 20345:2011

LPPOMCXX XX: 39, 40, 41, 42, 43, 44, 45, 46, 47 10

**3 SHOES (SAFETY FOOTWEAR)**

• ПОЛУБОТИНКИ (БЕЗОПАСНАЯ ОБУВЬ) • HALBSCHUHE (SICHERHEITSSCHUHE)

**S1  
SRC**



- MATERIAL: Upper: leather. Lining: knitwear mesh. Insole: replaceable. Sole: non-slip two-thickness polyurethane (on steel and ceramic surfaces), resistant to diesel oil, a deep tread ensures high footwear stability.
- SAFETY CAT.: S1 SRC
- The shoes have a steel toe cap and antistatic properties. They absorb energy in their heel part. They possess also a covered heel and reflective elements
- NORM: ISO 20345:2011

LPPOMAXX XX: 39, 40, 41, 42, 43, 44, 45, 46, 47 10

**4 SHOES WITH NO TOE CAP (OCCUPATIONAL FOOTWEAR)**

• ПОЛУБОТИНКИ БЕЗ ПОДНОСКА (ОБУВЬ ДЛЯ ПРОФЕССИОНАЛЬНОГО ИСПОЛЬЗОВАНИЯ)  
• HALBSCHUHE OHNE KAPPEN (BERUFSSCHUHE)

**O1  
SRC**



- MATERIAL: Upper: leather. Lining: knitwear mesh. Insole: replaceable. Sole: non-slip two-thickness polyurethane (on steel and ceramic surfaces), a deep tread ensures high footwear stability.
- SAFETY CAT.: O1 SRC
- The shoes have antistatic properties and a covered heel. They also absorb energy in the heel part.
- NORM: ISO 20347:2011

L30401XX XX: 39, 40, 41, 42, 43, 44, 45, 46, 47 10

**1 LADIES' SHOES (SAFETY FOOTWEAR)**

- ПОЛУБОТИНКИ ЖЕНСКИЕ (БЕЗОПАСНАЯ ОБУВЬ)
- DAMENHALBSCHUHE (SICHERHEITSSCHUHE)

**S1 SRC**

- MATERIAL: Upper: leather. Lining: knitwear mesh. Insole: replaceable. Sole: non-slip two-thickness polyurethane (on steel and ceramic surfaces), resistant to diesel oil, a deep tread and parabolic heel which ensure high footwear stability and comfort of walking.
- SAFETY CAT.: S1 SRC
- The shoes have a steel toe cap, antistatic properties and a covered heel. They also absorb energy in the heel part.
- NORM: ISO 20345:2011

**L30412XX**

XX: 36, 37, 38, 39, 40, 41, 42

**2 LADIES' SHOES WITH NO TOE CAP (OCCUPATIONAL FOOTWEAR)**

- ПОЛУБОТИНКИ ЖЕНСКИЕ БЕЗ ПОДНОСКА (ОБУВЬ ДЛЯ ПРОФЕССИОНАЛЬНОГО ИСПОЛЬЗОВАНИЯ)
- DAMENHALBSCHUHE OHNE KAPPEN (BERUFSSCHUHE)

**O1 SRC**

- MATERIAL: Upper: leather. Lining: knitwear mesh. Insole: replaceable. Sole: non-slip two-thickness polyurethane (on steel and ceramic surfaces), a deep tread and parabolic heel which ensure high footwear stability and comfort of walking.
- SAFETY CAT.: O1 SRC
- The shoes have antistatic properties and a covered heel. They also absorb energy in the heel part.
- NORM: ISO 20347:2011

**L30413XX**

XX: 36, 37, 38, 39, 40, 41, 42



**1 ANKLE BOOTS WITH NO TOE CAP (OCCUPATIONAL FOOTWEAR)**

• БОТИНКИ БЕЗ ПОДНОСКА (ОБУВЬ ДЛЯ ПРОФЕССИОНАЛЬНОГО ИСПОЛЬЗОВАНИЯ) • SCHNÜRSTIEFEL OHNE KAPPEN (BERUFSSCHUHE)

O2  
SRA



- MATERIAL: Upper: high-quality full-grain trekking „crazy horse” leather; outer boot front and back strengthened with TPR, high-quality metal eyelets. Lining: leather. Insole: replaceable leather. Sole: non-slip rubber (on ceramic surface), a deep tread ensures high footwear stability.
- SAFETY CAT.: O2 SRA
- The boots display antistatic properties. They absorb energy in their heel part. They possess also a covered heel, limited water permeability and absorption.
- NORM: ISO 20347:2011

L30115XX

XX: 39, 40, 41, 42, 43, 44, 45, 46, 47

10

**2 ANKLE BOOTS (SAFETY FOOTWEAR)**

• БОТИНКИ (БЕЗОПАСНАЯ ОБУВЬ) • SCHNÜRSTIEFEL (SICHERHEITSSCHUHE)

S3  
SRA



METAL  
FREE



- MATERIAL: Upper: nubuck, outer boot front and back strengthened with TPR. Lining: knitwear mesh. Insole: replaceable. Sole: non-slip rubber (ceramic surface), resistant to diesel oil, a deep tread ensures high footwear stability.
- SAFETY CAT.: S3 SRA
- The over-ankle shoes offer the following features: a composite toe cap, polymer insole, anti-electrostatic properties, energy absorption in the heel area, enclosed heel, limited permeability and water absorption. The shoes do not have any metal components.
- NORM: ISO 20345:2011

L30117XX

XX: 39, 40, 41, 42, 43, 44, 45, 46, 47

10

**3 ANKLE BOOTS (SAFETY FOOTWEAR)**

• БОТИНКИ (БЕЗОПАСНАЯ ОБУВЬ) • SCHNÜRSTIEFEL (SICHERHEITSSCHUHE)

S3  
SRA



METAL  
FREE



- MATERIAL: Upper: nubuck, TPR reinforced outer boot side and back. Lining: knitwear mesh. Insole: replaceable. Sole: non-slip two-thickness polyurethane (ceramic surface), resistant to diesel oil, a deep tread ensures high footwear stability.
- SAFETY CAT.: S3 SRA
- The over-ankle shoes offer the following features: a composite toe cap, polymer anti-puncture insole, anti-electrostatic properties, energy absorption in the heel area, enclosed heel, limited permeability and water absorption, and include reflective elements. The shoes do not have any metal components.
- NORM: ISO 20345:2011

L30118XX

XX: 39, 40, 41, 42, 43, 44, 45, 46, 47

10

**1 ANKLE BOOTS (SAFETY FOOTWEAR)**

• БОТИНКИ (БЕЗОПАСНАЯ ОБУВЬ) • SCHNÜRSTIEFEL (SICHERHEITSSCHUHE)



- MATERIAL: Upper: nubuck, outer boot front, side and back strengthened with TPR. Lining: knitwear mesh. Insole: replaceable. Sole: non-slip rubber (on steel and ceramic surfaces), a deep tread with a modern design ensures high footwear stability.
- SAFETY CAT.: SB SRC
- The boots have a steel toe cap.
- NORM: ISO 20345:2011

L30103XX    XX: 39, 40, 41, 42, 43, 44, 45, 46, 47    10

**2 ANKLE BOOTS (SAFETY FOOTWEAR)**

• БОТИНКИ (БЕЗОПАСНАЯ ОБУВЬ) • SCHNÜRSTIEFEL (SICHERHEITSSCHUHE)



- MATERIAL: Upper: nubuck, outer boot front, side and back strengthened with TPR, high-quality metal eyelets. Lining: knitwear mesh. Insole: replaceable. Sole: non-slip rubber (on ceramic surface), a deep tread ensures high footwear stability.
- SAFETY CAT.: SB SRA
- The boots have a steel toe cap.
- NORM: ISO 20345:2011

L30102XX    XX: 39, 40, 41, 42, 43, 44, 45, 46, 47    10

**3 ANKLE BOOTS (SAFETY FOOTWEAR)**

• БОТИНКИ (БЕЗОПАСНАЯ ОБУВЬ) • SCHNÜRSTIEFEL (SICHERHEITSSCHUHE)



- MATERIAL: Upper: nubuck / knitwear mesh, outer boot side strengthened with TPR. Lining: knitwear mesh. Insole: replaceable. Sole: non-slip rubber (on ceramic surface), resistant to diesel oil, a deep tread ensures high footwear stability.
- SAFETY CAT.: S1P SRA
- The boots have a composite toe cap, polymer anti-puncture insert, antistatic properties and covered heel. They also absorb energy in the heel part. The boots do not have any metal components.
- NORM: ISO 20345:2011

L30104XX    XX: 39, 40, 41, 42, 43, 44, 45, 46, 47    10

**4 ANKLE BOOTS (SAFETY FOOTWEAR)**

• БОТИНКИ (БЕЗОПАСНАЯ ОБУВЬ) • SCHNÜRSTIEFEL (SICHERHEITSSCHUHE)



- MATERIAL: Upper: leather / Oxford knitwear, outer boot side and back strengthened with TPR. Lining: knitwear mesh. Insole: replaceable. Sole: non-slip rubber (on ceramic surface), a deep tread ensures high footwear stability.
- SAFETY CAT.: SB SRA
- The boots have a steel toe cap.
- NORM: ISO 20345:2011

L30107XX    XX: 39, 40, 41, 42, 43, 44, 45, 46, 47    10

**1 ANKLE BOOTS (SAFETY FOOTWEAR)**

• БОТИНКИ (БЕЗОПАСНАЯ ОБУВЬ) • SCHNÜRSTIEFEL (SICHERHEITSSCHUHE)

**S1P SRA**

**RUBBER**



**Kat. II Cat. II** **CE**

- MATERIAL: Upper: suede, outer boot front and back strengthened with TPR, side cushions provide additional ankle protection, high-quality metal eyelets. Lining: knitwear mesh. Insole: replaceable. Sole: non-slip rubber (on ceramic surface), resistant to diesel oil, a deep tread ensures high footwear stability.
- SAFETY CAT.: S1P SRA
- The boots have a steel toe cap, steel anti-puncture insert, antistatic properties and covered heel. They also absorb energy in the heel part.
- NORM: ISO 20345:2011

**L30110XX**    **XX:** 39, 40, 41, 42, 43, 44, 45, 46, 47    10

**2 ANKLE BOOTS WITH NO TOE CAP (OCCUPATIONAL FOOTWEAR)**

• БОТИНКИ БЕЗ ПОДНОСКА (ОБУВЬ ДЛЯ ПРОФЕССИОНАЛЬНОГО ИСПОЛЬЗОВАНИЯ) • SCHNÜRSTIEFEL OHNE KAPPEN (BERUFSSCHUHE)

**O1 SRA**

**NO TOE CAP**

**RUBBER**



**Kat. II Cat. II** **CE**

- MATERIAL: Upper: suede, outer boot front, side and back strengthened with TPR, high-quality metal eyelets. Lining: knitwear mesh. Insole: replaceable. Sole: non-slip rubber (on ceramic surface), a deep tread ensures high footwear stability.
- SAFETY CAT.: O1 SRA
- The boots have antistatic properties and a covered heel. They also absorb energy in the heel part.
- NORM: ISO 20347:2011

**L30111XX**    **XX:** 39, 40, 41, 42, 43, 44, 45, 46, 47    10

**3 ANKLE BOOTS WITH NO TOE CAP (OCCUPATIONAL FOOTWEAR)**

• БОТИНКИ БЕЗ ПОДНОСКА (ПРОФЕССИОНАЛЬНАЯ ОБУВЬ) • SCHNÜRSTIEFEL OHNE KAPPEN (BERUFSSCHUHE)

**O2 SRA**

**NO TOE CAP**

**RUBBER**



**Kat. II Cat. II** **CE**

- MATERIAL: Upper: nubuck, outer boot front and back strengthened with TPR. Lining: knitwear mesh. Insole: replaceable. Sole: non-slip rubber (on ceramic surface), a deep tread ensures high footwear stability.
- SAFETY CAT.: O2 SRA
- The boots display antistatic properties. They absorb energy in their heel part. They possess also a covered heel, limited water permeability and absorption.
- NORM: ISO 20347:2011

**L30114XX**    **XX:** 39, 40, 41, 42, 43, 44, 45, 46, 47    10

**4 ANKLE BOOTS (SAFETY FOOTWEAR)**

• БОТИНКИ (БЕЗОПАСНАЯ ОБУВЬ) • SCHNÜRSTIEFEL (SICHERHEITSSCHUHE)

**SB FO SRA**

**RUBBER**



**Kat. II Cat. II** **CE**

- MATERIAL: Upper: suede. Lining: knitwear mesh. Insole: replaceable. Sole: non-slip rubber (on ceramic surface), resistant to diesel oil.
- SAFETY CAT.: SB FO SRA
- The boots have a steel toe cap.
- NORM: ISO 20345:2011

**L30108XX**    **XX:** 39, 40, 41, 42, 43, 44, 45, 46, 47    10

**1 ANKLE BOOTS (SAFETY FOOTWEAR)**

• БОТИНКИ (БЕЗОПАСНАЯ ОБУВЬ) • SCHNÜRSTIEFEL (SICHERHEITSSCHUHE)



- MATERIAL: Upper: suede, outer boot back strengthened with TPR. Lining: knitwear mesh. Insole: replaceable. Sole: non-slip rubber (on ceramic surface), a deep tread ensures high footwear stability.
- SAFETY CAT.: SB SRA
- The boots have a steel toe cap and The shoes do not have any metal components.

L30105XX XX: 39, 40, 41, 42, 43, 44, 45, 46, 47 10

**3 ANKLE BOOTS (SAFETY FOOTWEAR)**

• БОТИНКИ (БЕЗОПАСНАЯ ОБУВЬ) • SCHNÜRSTIEFEL (SICHERHEITSSCHUHE)



- MATERIAL: Upper: suede / knitwear mesh. Lining: knitwear mesh. Insole: replaceable. Sole: non-slip two-thickness polyurethane (on ceramic surface), resistant to diesel oil, a deep tread ensures high footwear stability.
- SAFETY CAT.: S1P SRA
- The boots have a steel toe cap, steel anti-puncture insert, antistatic properties and covered heel. They also absorb energy in the heel part.
- NORM: ISO 20345:2011

LPTOMFXX XX: 39, 40, 41, 42, 43, 44, 45, 46, 47 10

**2 ANKLE BOOTS (SAFETY FOOTWEAR)**

• БОТИНКИ (БЕЗОПАСНАЯ ОБУВЬ) • SCHNÜRSTIEFEL (SICHERHEITSSCHUHE)



- MATERIAL: Upper: nubuck. Lining: knitwear mesh. Insole: replaceable. Sole: non-slip two-thickness polyurethane (on steel and ceramic surfaces), resistant to diesel oil, a deep tread and parabolic heel which ensure high footwear stability and comfort of walking.
- SAFETY CAT.: S3 SRC
- The boots have a steel toe cap and steel anti-puncture insert, and antistatic properties. They absorb energy in their heel part. They possess also a covered heel, limited water permeability and absorption.
- NORM: ISO 20345:2011

L30113XX XX: 39, 40, 41, 42, 43, 44, 45, 46, 47 10

**4 ANKLE BOOTS (SAFETY FOOTWEAR)**

• БОТИНКИ (БЕЗОПАСНАЯ ОБУВЬ) • SCHNÜRSTIEFEL (SICHERHEITSSCHUHE)



- MATERIAL: Upper: suede/ knitwear mesh, high-quality metal eyelets. Lining: knitwear mesh. Insole: replaceable. Sole: non-slip two-thickness polyurethane (on steel and ceramic surfaces), resistant to diesel oil, a deep tread ensures high footwear stability.
- SAFETY CAT.: S1P SRC
- The boots have a steel toe cap, steel anti-puncture insert, antistatic properties and covered heel. They also absorb energy in the heel part.
- NORM: ISO 20345:2011

L30106XX XX: 39, 40, 41, 42, 43, 44, 45, 46, 47 10

**1 ANKLE BOOTS (SAFETY FOOTWEAR)**

• БОТИНКИ (БЕЗОПАСНАЯ ОБУВЬ) • SCHNÜRSTIEFEL (SICHERHEITSSCHUHE)



- MATERIAL: Upper: suede. Lining: knitwear mesh Insole: replaceable. Sole: non-slip two-thickness polyurethane (on ceramic surface), resistant to diesel oil, a deep tread ensures high footwear stability.
- SAFETY CAT.: S1P SRA
- The boots have a steel toe cap, steel anti-puncture insert, antistatic properties and covered heel. They also absorb energy in the heel part.
- NORM: ISO 20345:2011

L30109XX XX: 39, 40, 41, 42, 43, 44, 45, 46, 47 10

**3 ANKLE BOOTS (SAFETY FOOTWEAR)**

• БОТИНКИ (БЕЗОПАСНАЯ ОБУВЬ) • SCHNÜRSTIEFEL (SICHERHEITSSCHUHE)



- MATERIAL: Upper: leather. Lining: cambrella knitwear. Insole: replaceable. Sole: non-slip single-thickness polyurethane (on steel and ceramic surfaces), resistant to diesel oil, a deep tread ensures high footwear stability and comfort of walking.
- SAFETY CAT.: S1P SRC
- The boots have a steel toe cap, steel anti-puncture insert, antistatic properties and covered heel. They also absorb energy in the heel part.
- NORM: ISO 20345:2011

LPTOMEXX XX: 39, 40, 41, 42, 43, 44, 45, 46, 47 10

**2 ANKLE BOOTS (SAFETY FOOTWEAR)**

• БОТИНКИ (БЕЗОПАСНАЯ ОБУВЬ) • SCHNÜRSTIEFEL (SICHERHEITSSCHUHE)



- MATERIAL: Upper: leather. Lining: knitwear mesh. Insole: replaceable. Sole: non-slip two-thickness polyurethane (on ceramic surface), resistant to diesel oil, a deep tread and parabolic heel which ensure high footwear stability and comfort of walking.
- SAFETY CAT.: S1 SRA
- The boots have a composite toe cap, antistatic properties and a covered heel. They also absorb energy in the heel part. The boots do not have any metal components.
- NORM: ISO 20345:2011

LPTOMDXX XX: 39, 40, 41, 42, 43, 44, 45, 46, 47 10

**4 ANKLE BOOTS (SAFETY FOOTWEAR)**

• БОТИНКИ (БЕЗОПАСНАЯ ОБУВЬ) • SCHNÜRSTIEFEL (SICHERHEITSSCHUHE)



- MATERIAL: Upper: leather. Lining: knitwear mesh. Insole: replaceable. Sole: non-slip two-thickness polyurethane (on steel and ceramic surfaces), resistant to diesel oil, a deep tread and parabolic heel which ensure high footwear stability and comfort of walking.
- SAFETY CAT.: S3 SRC
- The boots have a steel toe cap and steel anti-puncture insert, and antistatic properties. They absorb energy in their heel part. They possess also a covered heel, limited water permeability and absorption.
- NORM: ISO 20345:2011

LPTOMGXX XX: 39, 40, 41, 42, 43, 44, 45, 46, 47 10



**1 ANKLE BOOTS (SAFETY FOOTWEAR)**

• БОТИНКИ (БЕЗОПАСНАЯ ОБУВЬ) • SCHNÜRSTIEFEL (SICHERHEITSSCHUHE)

**S1  
SRC**

- MATERIAL: Upper: leather. Lining: knitwear mesh. Insole: replaceable. Sole: non-slip two-thickness polyurethane (on steel and ceramic surfaces), resistant to diesel oil, a deep tread ensures high footwear stability.
- SAFETY CAT.: S1 SRC
- The boots have a steel toe cap and display antistatic properties. They absorb energy in their heel part. They possess also a covered heel and reflective elements
- NORM: ISO 20345:2011

LPTOMCXX XX: 39, 40, 41, 42, 43, 44, 45, 46, 47

**2 ANKLE BOOTS (SAFETY FOOTWEAR)**• БОТИНКИ БЕЗ ПОДНОСКА (ОБУВЬ ДЛЯ ПРОФЕССИОНАЛЬНОГО ИСПОЛЬЗОВАНИЯ)  
• SCHNÜRSTIEFEL OHNE KAPPEN (BERUFSSCHUHE)**O1  
SRC**

- MATERIAL: Upper: leather. Lining: knitwear mesh. Insole: replaceable. Sole: non-slip two-thickness polyurethane (on steel and ceramic surfaces), a deep tread ensures high footwear stability.
- SAFETY CAT.: O1 SRC
- The boots have antistatic properties and a covered heel. They also absorb energy in the heel part.
- NORM: ISO 20347:2011

L30101XX XX: 39, 40, 41, 42, 43, 44, 45, 46, 47

**3 ANKLE BOOTS (SAFETY FOOTWEAR)**

• БОТИНКИ (БЕЗОПАСНАЯ ОБУВЬ) • SCHNÜRSTIEFEL (SICHERHEITSSCHUHE)

**SB FO  
SRC**

- MATERIAL: Upper: leather. Lining: knitwear mesh. Insole: replaceable. Sole: non-slip one-thickness polyurethane (steel and ceramic surface), resistant to diesel oil, a deep tread ensures high footwear stability.
- SAFETY CAT.: SB FO SRC
- The over-ankle shoes have a steel toe cap.
- NORM: ISO 20345: 2011

L30116XX

XX: 39, 40, 41, 42, 43, 44, 45, 46, 47





**1 HIGH PADDED BOOTS (SAFETY FOOTWEAR)**

- ВЫСОКИЕ УТЕПЛЕННЫЕ БОТИНКИ (БЕЗОПАСНАЯ ОБУВЬ)
- SCHNÜRSTIEFEL GEFÜTTERT HOCH (SICHERHEITSSCHUHE)

S3 SRC

METAL FREE



- MATERIAL: Upper: leather: Lining: fur knitwear: Insole: replaceable. Sole: non-slip two-thickness polyurethane (on steel and ceramic surfaces), resistant to diesel oil, a deep tread and parabolic heel which ensure high footwear stability and comfort of walking.
- SAFETY CAT.: S3 SRC
- The boots have a composite toe cap and polymer anti-puncture insert, and antistatic properties. They absorb energy in their heel part. They possess also a covered heel, limited water permeability and absorbent elements components. The boots do not have any metal components.
- NORM: ISO 20345:2011

L30301XX XX: 39, 40, 41, 42, 43, 44, 45, 46, 47 10

**2 HIGH PADDED BOOTS (SAFETY FOOTWEAR)**

- ВЫСОКИЕ УТЕПЛЕННЫЕ БОТИНКИ (БЕЗОПАСНАЯ ОБУВЬ)
- SCHNÜRSTIEFEL GEFÜTTERT HOCH (SICHERHEITSSCHUHE)

S3 SRC



- MATERIAL: Upper: leather: Lining: fur knitwear: Insole: replaceable. Sole: non-slip two-thickness polyurethane (on steel and ceramic surfaces), resistant to diesel oil, a deep tread ensures high footwear stability.
- SAFETY CAT.: S3 SRC
- The boots have a steel toe cap and steel anti-puncture insert, and antistatic properties. They absorb energy in their heel part. They possess also a covered heel, limited water permeability and absorption.
- NORM: ISO 20345:2011

L30302XX XX: 39, 40, 41, 42, 43, 44, 45, 46, 47 10

**1 PADDED ANKLE BOOTS (SAFETY FOOTWEAR)**

• УТЕПЛЕННЫЕ БОТИНКИ (БЕЗОПАСНАЯ ОБУВЬ) • SCHNÜRSTIEFEL GEFÜTTERT (SICHERHEITSSCHUHE)

S3 SRC



- MATERIAL: Upper: leather. Lining: fur knitwear. Insole: replaceable. Sole: non-slip two-thickness polyurethane (on steel and ceramic surfaces), resistant to diesel oil, a deep tread ensures high footwear stability.
- SAFETY CAT.: S3 SRC
- The boots have a steel toe cap and steel anti-puncture insert, and display antistatic properties. They absorb energy in their heel part. They possess also a covered heel, limited water permeability and absorption.
- NORM: ISO 20345:2011

L30303XX XX: 39, 40, 41, 42, 43, 44, 45, 46, 47 10

**2 SNOW BOOTS**

• БОТИНКИ ЗИМНИЕ ДУТЫЕ • SCHNEESTIEFEL

HIGH QUALITY TPR



- MATERIAL: Upper: suede/ Oxford knitwear; high-quality metal eyelets. Lining: knitwear mesh. Insole: replaceable fur. Sole: high-quality TPR.

L30801XX XX: 39, 40, 41, 42, 43, 44, 45, 46, 47 12

**3 SNOW BOOTS**

• БОТИНКИ ЗИМНИЕ ДУТЫЕ • SCHNEESTIEFEL

HIGH QUALITY TPR



- MATERIAL: Upper: artificial suede. Lining: knitwear mesh. Insole: replaceable fur. Sole: high-quality TPR.

L30804XX XX: 39, 40, 41, 42, 43, 44, 45, 46, 47 12

**4 SNOW BOOTS**

• БОТИНКИ ЗИМНИЕ ДУТЫЕ • SCHNEESTIEFEL

HIGH QUALITY TPR



- MATERIAL: Upper: artificial leather. Lining: replaceable fur knitwear, tinfoil improving thermal insulation properties. Sole: high-quality TPR.

L30802XX XX: 39, 40, 41, 42, 43, 44, 45, 46 8

PROLINE

LAHTI PRO

MEGA

JUCCO

OTHER BRANDS

ENDI

KLINGSPOR

EXPRESS

ACTION CAN

TRITON

VULCAN

PROLINE

LAHTI PRO

MEGA

JUCO

OTHER BRANDS

ERDI

KLINGSPOR

EXPRESS

ACTION CAN

TRYTON

VULCAN

**1 HIGH WELLINGTON BOOTS WITH NO TOE CAP (OCCUPATIONAL FOOTWEAR)**

- ВЫСОКИЕ НЕПРОМОКАЕМЫЕ САПОГИ БЕЗ ПОДНОСКА (ОБУВЬ ДЛЯ ПРОФЕССИОНАЛЬНОГО ИСПОЛЬЗОВАНИЯ)
- GUMMISTIEFEL OHNE KAPPEN HOCH (BERUFSSCHUHE)

**O4 SRA**



- MATERIAL: Upper: PVC. Lining: knitwear Sole: Non-slip PVC (on ceramic surface).
- SAFETY CAT.: O4 SRA
- The wellingtons have antistatic properties and a covered heel. They also absorb energy in the heel part.
- NORM: ISO 20347:2011

**LPKOMAXX** XX: 39, 40, 41, 42, 43, 44, 45, 46, 47 10

**2 HIGH WELLINGTONS WITH NO TOE CAP (OCCUPATIONAL FOOTWEAR)**

- ВЫСОКИЕ НЕПРОМОКАЕМЫЕ САПОГИ БЕЗ ПОДНОСКА (ОБУВЬ ДЛЯ ПРОФЕССИОНАЛЬНОГО ИСПОЛЬЗОВАНИЯ)
- GUMMISTIEFEL OHNE KAPPEN HOCH (BERUFSSCHUHE)

**OB SRA**



- MATERIAL: Upper: PVC. Lining: knitwear Sole: Non-slip PVC (on ceramic surface).
- SAFETY CAT.: OB SRA
- NORM: ISO 20347:2011

**L30702XX** XX: 40, 41, 42, 43, 44, 45, 46, 47 5

**3 MEDIUM-HIGH WELLINGTONS WITH NO TOE CAP (OCCUPATIONAL FOOTWEAR)**

- СРЕДНЕВЫСОКИЕ НЕПРОМОКАЕМЫЕ САПОГИ БЕЗ ПОДНОСКА (ОБУВЬ ДЛЯ ПРОФЕССИОНАЛЬНОГО ИСПОЛЬЗОВАНИЯ)
- GUMMISTIEFEL OHNE KAPPEN HALBHOCH (BERUFSSCHUHE)

**OB E**



- MATERIAL: Upper: PVC. Lining: knitwear Sole: PVC.
- SAFETY CAT.: OB E
- The wellingtons absorb energy in the heel part.
- NORM: EN ISO 20347:2004

**L30701XX** XX: 41, 42, 43, 44 8  
XX: 45, 46, 47 6

**4 HIGH WELLINGTONS (SAFETY FOOTWEAR)**

- ВЫСОКИЕ НЕПРОМОКАЕМЫЕ САПОГИ (БЕЗОПАСНАЯ ОБУВЬ)
- REGENSTIEFEL HOCH (SICHERHEITSSCHUHE)

**demar.**



- MATERIAL: Upper: modified PVC. Lining: polyester knitwear. Sole: oil-proof PVC.
- SAFETY CAT.: S5
- Additional ankle protection.
- NORM: PN EN ISO 20345:2012

**DKRMCXX** XX: 40, 41, 42, 43, 44, 45, 46, 47, 48 5

**5 HIGH WELLINGTONS WITH PADDING**

- ВЫСОКИЕ НЕПРОМОКАЕМЫЕ УТЕПЛЕННЫЕ САПОГИ
- GUMMISTIEFEL MIT WÄRMEDÄMMENDEM VLIES HOCH

**demar.**



- MATERIAL: Upper: EVA. Sole: EVA.
- Highly durable, offering thermal insulation, flexible, ultralight; hardened sole and toe cap. Can be used with padding or without it (removable).

**DKMBXX** XX: 40, 41, 42, 43, 44, 45, 46, 47 4

**6 MEDIUM-HIGH WELLINGTONS WITH A CUFF AND PADDING**

- СРЕДНЕВЫСОКИЕ УТЕПЛЕННЫЕ НЕПРОМОКАЕМЫЕ САПОГИ С ВОРОТНИКОМ - GUMMISTIEFEL MIT KRAGEN UND WÄRMEDÄMMENDEM VLIES HALBHOCH



- MATERIAL: Upper: EVA / waterproof polyester collar with adjustable width. Padding: thick felt. Sole: EVA.
- Highly durable, retain their flexibility and thermal insulation properties even in -30°C. Can be used with a padding or without it (removable).

**K15361XX** XX: 42, 43, 44, 45, 46, 47, 48 5

**1 MEDIUM-HIGH WELLINGTONS WITH PADDING**

- СРЕДНЕВЫСОКИЕ НЕПРОМОКАЕМЫЕ УТЕПЛЕННЫЕ САПОГИ
- GUMMISTIEFEL MIT WÄRMEDÄMMENDEM VLIES HALBHOC

**EVA**

- MATERIAL: Upper: EVA. Padding: thick felt. Sole: EVA.
- Highly durable, retain their flexibility and thermal insulation properties even in -30°C. Can be used with a padding or without it (removable).

**K15461XX** XX: 42, 43, 44, 45, 46, 47, 48  5

**2 MEDIUM-HIGH LADIE'S WELLINGTONS WITH PADDING**

- СРЕДНЕВЫСОКИЕ НЕПРОМОКАЕМЫЕ ЖЕНСКИЕ УТЕПЛЕННЫЕ САПОГИ - GUMMISTIEFEL MIT WÄRMEDÄMMENDEM VLIES HALBHOC

**EVA**

- MATERIAL: Upper: EVA. Padding: thick felt. Sole: EVA.
- Highly durable, retain their flexibility and thermal insulation properties even in -30°C. Can be used with a padding or without it (removable).

**K15162XX** XX: 36, 37, 38, 39, 40, 41, 42  7

**3 FELT WELLINGTONS**

- САПОГИ НЕПРОМОКАЕМЫЕ С ВОЙЛОЧНЫМ ВЕРХОМ
- FILZ-GUMMISTIEFEL

**OB FO  
CI SRC****PVC****Kat. II  
Cat. II**

- MATERIAL: Upper: Italian PVC/felt. Lining: felt/tinfoil (improving thermal insulation properties). Sole: PVC, special design, ensuring improved grip to the ground
- NORM: ISO 20347:2012

**K15121XX** XX: 40, 41, 42, 43, 44, 45, 46  5

**4 LADIES' MEDIUM-HIGH WELLINGTONS**

- СРЕДНЕВЫСОКИЕ НЕПРОМОКАЕМЫЕ ЖЕНСКИЕ САПОГИ
- DAMENGUMMISTIEFEL HALBHOC

**demar.**

- MATERIAL: Upper: PVC insole: chemically bonded nonwoven fabric. Sole: PVC.

**DKDPXX** XX: 36/37, 37/38, 38/39, 39/40, 40/41  10

**5 MID-HIGH LADIES' WELLINGTON BOOTS**

- СРЕДНЕВЫСОКИЕ НЕПРОМОКАЕМЫЕ ЖЕНСКИЕ САПОГИ
- DAMENGUMMISTIEFEL HALBHOC

**demar.****CE**

- MATERIAL: Upper: PVC. Sole: PVC. Lining: polyester knitwear. Insole: replaceable nonwoven fabric.
- NORM: 89/686/EWG

**DKDDXX** XX: 36, 37, 38, 39, 40, 41, 42  5

**6 CLOGS**

- ШЛЕПАНЦЫ ТИПА „CLOGS“ • CLOGS

**EVA**

- MATERIAL: Upper: EVA. Sole: EVA. Insert: non-slip inside preventing the foot from slipping off the shoe.
- Highly durable, flexible and with excellent thermal insulation. Perfect for men and women.

**K14153XX** XX: 37, 38, 39, 40, 41, 42, 43, 44, 45, 46  16

PROLINE

LAHTI PRO

MEGA

JUCO

OTHER BRANDS

ERDI

KLINGSPOR

EXPRESS

ACTION CAN

TRAYTON

VULCAN

**1 SANDALS (SAFETY FOOTWEAR)**

- САНДАЛИ (БЕЗОПАСНАЯ ОБУВЬ)
- SANDALEN (SICHERHEITSSCHUHE)

**Demar.**



**SB SRC**



- MATERIAL: Upper: suede. Lining: 3D knitwear. Insole: replaceable, anatomically moulded. Sole: LIGHT SOLE, two-thickness polyurethane.
- SAFETY CAT.: SB SRC
- NORM: ISO 20345:2012

**DSRMWXX** XX: 40, 41, 42, 43, 44, 45, 46, 47  5

**2 "HUNTING" SHOES**

- ПОЛУБОТИНКИ «ХОТЯНИЧЬИ» • „JÄGER“-HALBSCHUHE

**Demar.**



- MATERIAL: Upper: waterproof nubuck leather. Lining: 3D knitwear. Insole: replaceable, 3D knitwear CLIMATIC. Sole: LIGHT SOLE, two-thickness polyurethane.

**DPMMAXX** XX: 42, 43, 44, 46,  5

**3 SANDALS (SAFETY FOOTWEAR)**

- САНДАЛИ (БЕЗОПАСНАЯ ОБУВЬ)
- SANDALEN (SICHERHEITSSCHUHE)

**Demar.**



**S1 SRC**



- MATERIAL: Upper: leather. Lining: 3D knitwear Insole: replaceable: anatomically moulded Sole: LIGHT SOLE, two-thickness polyurethane.
- NORM: PN EN ISO 20345:2012

**DSRMXX** XX: 40, 41, 42, 43, 44, 45, 46, 47, 48  5

**4 SHOES (SAFETY FOOTWEAR)**

- ПОЛУБОТИНКИ (БЕЗОПАСНАЯ ОБУВЬ)
- HALBSCHUHE (SICHERHEITSSCHUHE)

**Demar.**

**S1 SRC**



- MATERIAL: Upper: suede, polyester knitwear. Lining: 3D knitwear. Insole: replaceable, anatomically moulded. Sole: GRIMM, two-thickness polyurethane with the cutting-edge, aggressive design and deep non-slip tread; with additional toe protection on the front.
- SAFETY CAT.: S1 SRC
- NORM: ISO 20345:2012

**DPRMCXX** XX: 40, 41, 42, 43, 44, 45, 46, 47, 48  5

**5 ANKLE BOOTS (SAFETY FOOTWEAR)**

- БОТИНКИ (БЕЗОПАСНАЯ ОБУВЬ)
- HALBSCHUHE (SICHERHEITSSCHUHE)

**Demar.**

**S1 SRC**



- MATERIAL: Upper: suede, polyester knitwear. Lining: 3D knitwear. Insole: replaceable, anatomically moulded. Sole: GRIMM, two-thickness polyurethane with the cutting-edge, aggressive design and deep non-slip tread; with additional toe protection on the front.
- SAFETY CAT.: S1 SRC
- NORM: ISO 20345:2012

**DTRMCXX** XX: 41, 45  5

**6 ANKLE BOOTS (SAFETY FOOTWEAR)**

- БОТИНКИ (БЕЗОПАСНАЯ ОБУВЬ) • SCHNÜRSTIEFEL (SICHERHEITSSCHUHE)

**Demar.**

**S2 SRC**



- MATERIAL: Upper: waterproof leather. Lining: 3D knitwear. Insole: replaceable, anatomically moulded. Sole: GRIMM, two-thickness polyurethane with the cutting-edge, aggressive design and deep non-slip tread; with additional toe protection on the front.
- SAFETY CAT.: S2 SRC
- NORM: ISO 20345:2012 Kat. II

**DTRMAXX** XX: 40, 41, 42, 43, 44, 45, 46, 47, 48  5

**1 ANKLE BOOTS (SAFETY FOOTWEAR)**

• БОТИНКИ (БЕЗОПАСНАЯ ОБУВЬ) - SCHNÜRSTIEFEL (SICHERHEITSSCHUHE)

**demar.**

S3  
SRC



- MATERIAL: Sole: GRIMM, double-density polyurethane with the most modern, aggressive design and a deep non-slip tread; the front part has additional protection for toes.
- SAFETY CAT.: S3 SRC

DTRMBUXX

XX: 40, 41, 42, 43, 44,  
45, 46, 47, 48



**2 HIGH PADDED BOOTS (SAFETY FOOTWEAR)**

• ВЫСОКИЕ УТЕПЛЁННЫЕ БОТИНКИ (БЕЗОПАСНАЯ ОБУВЬ) - SCHNÜRSTIEFEL GEFÜTTERT HOCH (SICHERHEITSSCHUHE)

**demar.**

S2  
SRC



- MATERIAL: Upper: waterproof leather. Lining: fur knitwear. Insole: replaceable, moulded. Sole: GRIMM, two-thickness polyurethane with the cutting-edge, aggressive design and deep non-slip tread; with additional toe protection on the front.
- SAFETY CAT.: S2 SRC
- NORM: ISO 20345:2012

DTRMFXX

XX: 40, 41, 42, 43, 44,  
45, 46, 47, 48



PROLINE

LAHTI PRO

MEGA

JUCCO

OTHER BRANDS

ERDI

KLINGSPOR

EXPRESS

ACTION CAN

TRYTON

VULCAN

**1 KNEE PADS WITH GEL-AIR CUSHION (TYPE 1)**

- ПРОТЕКТОРЫ КОЛЕННЫХ СУСТАВОВ С ВОЗДУШНО-ГЕЛЕВОЙ ПОДУШКОЙ (ТИП 1)
- KNIESCHONER MIT GEL-LUFT-KISSEN (TYP 1)



HEAVY DUTY Kat. I Cat. I CE

- MATERIAL: 600D polyester
- Double protective layer [extra thick]. Innovative technology - special shape of the gel and air cushion fits the shape of the surface, ensuring full stability of knees. Adjustable Velcro fastening.
- NORM: EN 14404

Code		
52311	x	6/24

**2 ELASTIC CUSHION KNEE PADS (TYPE 1)**

- ПРОТЕКТОРЫ КОЛЕННЫХ СУСТАВОВ С ЭЛАСТИЧНОЙ ПОДУШКОЙ (ТИП 1) • KNIESCHONER MIT ELASTISCHEM KISSEN (TYP 1)



HEAVY DUTY Kat. I Cat. I CE

- MATERIAL: 600D polyester
- Elastic cushion with the shape adjusting to the knee. Thick protective layer: Double, adjustable Velcro fastening.
- NORM: EN 14404

Code		
52308	x	6/24

**3 KNEE PADS WITH GEL-AIR CUSHION (TYPE 1)**

- ПРОТЕКТОРЫ КОЛЕННЫХ СУСТАВОВ С ВОЗДУШНО-ГЕЛЕВОЙ ПОДУШКОЙ (ТИП 1) • KNIESCHONER MIT GEL-LUFT-KISSEN (TYP 1)



HEAVY DUTY Kat. I Cat. I CE

- MATERIAL: 600D polyester
- Gel-air cushion. Double protective layer [extra thick]. Adjustable Velcro fastening.
- NORM: EN 14404

Code		
52306	x	6/24

**4 KNEE PADS WITH PVC PROTECTION (TYPE 1)**

- ПРОТЕКТОРЫ КОЛЕННЫХ СУСТАВОВ С ПВХ ЗАЩИТОЙ (ТИП 1)
- KNIESCHONER MIT PVC-SCHUTZ (TYP 1)



HEAVY DUTY Kat. I Cat. I CE

- MATERIAL: 600D polyester
- Hard PVC cushion. Thick protective layer. Double, adjustable velcro fastening.
- NORM: EN 14404

Code		
52310	x	6/24

**5 KNEE PADS WITH SOFT PROTECTION (TYPE 1)**

- ПРОТЕКТОРЫ КОЛЕННЫХ СУСТАВОВ С МЯГКОЙ ЗАЩИТОЙ (ТИП 1) • KNIESCHONER MIT WEICHEN SCHÜTZERN (TYP 1)



HEAVY DUTY Kat. I Cat. I CE

- MATERIAL: 600D polyester
- Soft cushion protects the surface from scratching. Thick protective layer. Adjustable Velcro fastening.
- NORM: EN 14404

Code		
52309	x	6/24

**6 KNEE PADS (TYPE 2)**

- ПРОТЕКТОРЫ КОЛЕННЫХ СУСТАВОВ (ТИП 2)
- KNIESCHONER (TYP 2)



20 mm x 160 mm x 240 mm

Kat. I Cat. I CE

- MATERIAL: EVA/POE.
- Knee-pads for protective trousers and bib pants with pockets for knee pads [it is possible to adjust the knee-pad size by cutting them to match the size of pockets in trousers or bib pants]. Thanks to their double thickness, they ensure high comfort of work. Ideal for works requiring kneeling i.e. finishing, construction, gardening works etc.
- NORM: EN 14404

Code		
LPN001	x	50



**1 LEATHER KNEE PROTECTORS (TYPE 1)**

• ЗАЩИТА КОЛЕН ИЗ КОЖИ (ТИП 1) • KNIESCHONER AUS LEDER (TYP 1)



- MATERIAL: Resin-reinforced Russia leather
- Made of resin-reinforced Russia leather which provides high abrasion resistance. Thick layer of material on the inside adapts to the knee's shape. Adjustable straps ensure smooth adjustment.
- NORM: EN 14404

Code		
L3100201	x	15

**2 KNEE PADS WITH PVC PROTECTION (TYPE 1)**

• ПРОТЕКТОРЫ КОЛЕННЫХ СУСТАВОВ С ПВХ ЗАЩИТОЙ (ТИП 1)  
• KNIESCHONER MIT PVC-SCHUTZ (TYP 1)



- MATERIAL: 600D polyester
- Hard PVC cushion. Double, adjustable velcro fastening.
- NORM: EN 14404

Code		
52300	x	6/36

**3 KNEE PADS (TYPE 1)**

• ПРОТЕКТОРЫ КОЛЕННЫХ СУСТАВОВ (ТИП 1)  
• KNIESCHONER (TYP 1)



- MATERIAL: Waterproof, synthetic leather
- Flexible, ensuring freedom of movements. Resistant to crumbling and breaking. 52301 - single Velcro fastening. 52302 - double Velcro fastening.
- NORM: EN 14404

Code		
52301	x	6
52302	x	6

**4 KNEE PROTECTORS (TYPE 1)**

• ПРОТЕКТОРЫ КОЛЕННЫХ СУСТАВОВ (ТИП 1) • KNIESCHONER (TYP 1)



- MATERIAL: PU.
- Made of soft and flexible polyurethane, which protects the from scratches and adapts perfectly to the shape of the knee. Adjustable strap.
- NORM: EN 14404

Code		
L3100101	x	36

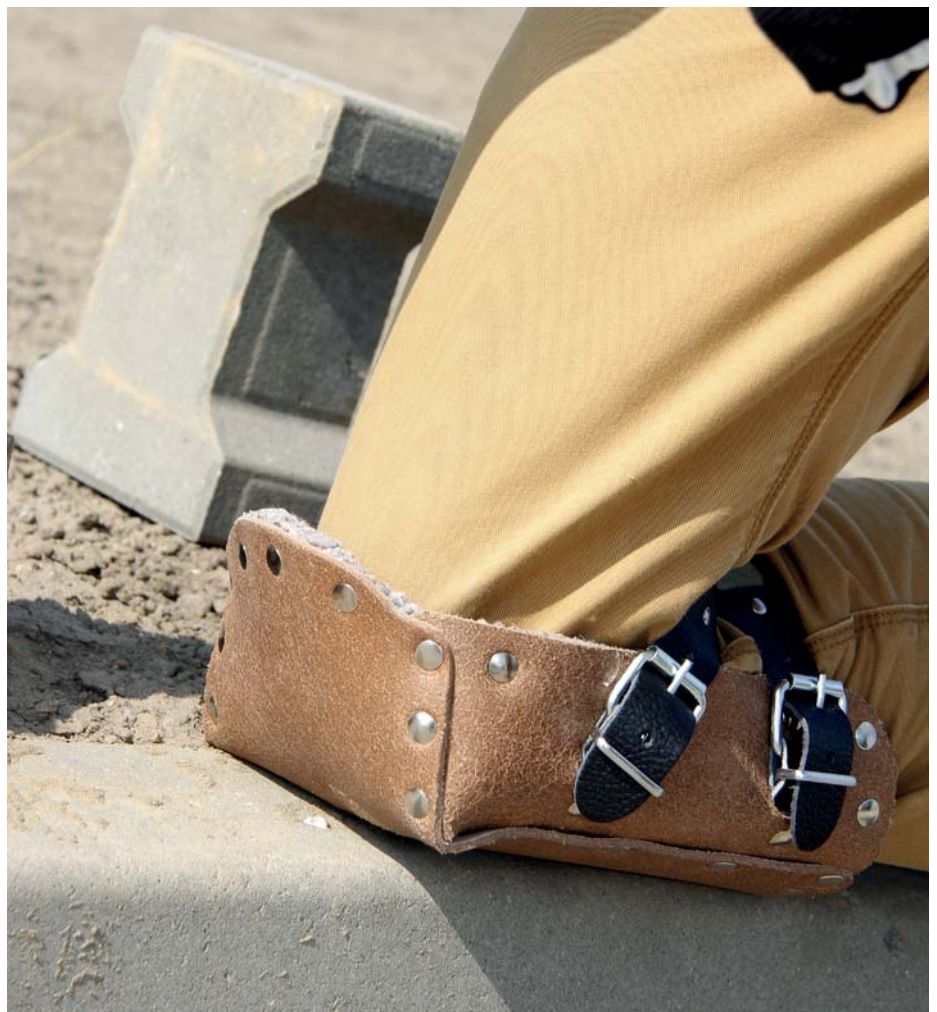



### 1 SPORT SHOE INSOLES

- СПОРТИВНЫЕ СТЕЛКИ ДЛЯ ОБУВИ
- EINLAGEN FÜR SPORTSCHUHE



EVA  
LATEX  
TPR

- **MATERIAL:** Three-layer structure - polyester fabric / EVA / inserts: TPR, EVA, latex, 4 mm thick.
- The insoles have a soft and flexible TPR shock-absorbing cushion and latex and EVA bottom inserts to relieve the pressure of the foot on the floor. The structured surface supports and stabilizes the foot, preventing the occurrence of flat foot. The design of the insoles reduces foot fatigue and increases comfort while walking. The perforated surface assures air circulation inside the shoe. Perfect for those who lead an active lifestyle.

L90306XX XX: 39, 40, 41, 42, 43, 44, 45, 46, 47   40

### 4 THERMAL INSOLES

- ТЕРМОСТЕЛКИ ДЛЯ ОБУВИ • THERMOSCHUHEINLAGEN



 x10

- **MATERIAL:** Three-layer construction - high-quality felt/foam/aluminum film, 6 mm thick.
- The insoles provide increased thermal insulation, absorb moisture, facilitate adaptation to the shape of the foot and relieve the pressure of the foot on the ground. Perfect for the autumn and winter season.

L90302XX XX: 39, 40, 41, 42, 43, 44, 45, 46, 47  10

### 2 SHOE INSOLES WITH ANTISTATIC THREAD

- СТЕЛКИ ДЛЯ ОБУВИ С АНТИСТАТИЧЕСКОЙ НИТЬЮ
- EINLAGEN FÜR SCHUHE MIT ANTISTATISCHEM FADEN

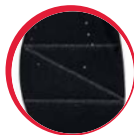



Antielectrostatic thread



EVA  
LATEX

- **MATERIAL:** Three-layer structure - polyester fabric / EVA / inserts: latex, antielectrostatic thread, 4.5 mm thickness
- The insoles have latex bottom inserts to relieve the pressure of the foot on the floor. The design of the insoles reduces foot fatigue and increases comfort while walking. The perforated surface assures air circulation inside the shoe. **The insoles are meant for footwear with anti-static properties**

L90307XX XX: 39, 40, 41, 42, 43, 44, 45, 46, 47   40

### 5 ANTIBACTERIAL INSOLES

- СТЕЛКИ ДЛЯ ОБУВИ С АНТИБАКТЕРИАЛЬНОЙ ПРОПИТКОЙ
- ANTIKARRIERELLE SCHUHEINLAGEN



 x10

- **MATERIAL:** Two-layer structure - cotton fabric/ latex, thickness 3 mm.
- The insoles contain an antibacterial and fungicidal agent from the Swiss company Sanitized. They protect feet against bacteria, fungi, yeasts and mites that are responsible for unpleasant odors. The perforated surface assures air circulation inside the shoe and gives a fresh feeling. The latex layer prevents the insole from moving inside the shoe. The insoles are recommended for sensitive feet.

L90303XX XX: 39, 40, 41, 42, 43, 44, 45, 46, 47  10

### 3 FELT INSOLES

- СТЕЛКИ ДЛЯ ОБУВИ ВОЙЛОЧНЫЕ • EINLAGEN FÜR SCHUHE MIT ANTISTATISCHEM FADEN



 x10

- **MATERIAL:** High quality felt, 6mm thick.
- The insoles ensure thermal protection, absorb moisture and relieve the pressure of the foot on the floor. Perfect for autumn and winter season.

L90301XX XX: 39, 40, 41, 42, 43, 44, 45, 46, 47  10

### 6 ANTIPERSPIRANT INSOLES

- СТЕЛКИ ОТ ПОТА • ANTI-SCHWEISS-SCHUHEINLAGEN



 x10

- **MATERIAL:** Two-layer structure - cotton fabric/ latex, thickness 3 mm
- The insoles contain an agent with activated carbon, reduce excessive sweating and neutralize unpleasant odors. The perforated surface assures air circulation inside the shoe and gives a fresh feeling. The latex layer prevents the insole from moving inside the shoe.

L90304XX XX: 39, 40, 41, 42, 43, 44, 45, 46, 47  10

**1 MILITARY INSOLES**

- СТЕЛЬКИ ДЛЯ ВОЕННОЙ ОБУВИ
- EINLAGEN FÜR MILITÄRSCHUHE

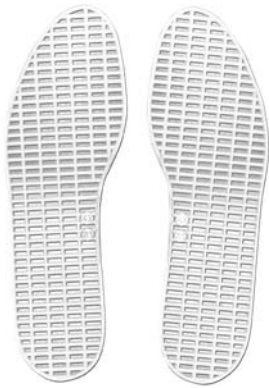

- MATERIAL: polyethylene
- Thanks to a mesh structure the insoles assure excellent air circulation inside the shoe and prevent sweating. The insoles are particularly adapted to closed shoes, with limited ventilation. They are flexible, durable and resistant to damage.

L90305XX XX: 39, 40, 41, 42, 43, 44, 45, 46, 47 20

**2 ROUND SHOE LACES**

- КРУГЛЫЕ ШНУРКИ ДЛЯ БОТИНОК 'ТРЕККИНГОВЫЕ' • RUNDE SCHNÜRSENKEL



100% POLYESTER **x10 PAIRS**

- MATERIAL: 100% polyester
- Round, „trekking” laces with a diameter of 4 mm, reinforced with a core increasing resistance to abrasion and tearing. Available in 4 colour versions and lengths: 100 cm, 120 cm and 150 cm

Code	Size [cm]	Colour	
L9040100	100		10/120
L9040120	120		10/120
L9040150	150		10/120
L9040200	100		10/120
L9040220	120		10/120
L9040250	150		10/120
L9040300	100		10/120
L9040320	120		10/120
L9040350	150		10/120
L9040400	100		10/120
L9040420	120		10/120
L9040450	150		10/120

Each pair comes with a bar code

**3 FLAT SHOE LACES**

- ПЛОСКИЕ ШНУРКИ ДЛЯ БОТИНОК • FLACHE SCHNÜRSENKEL



100% COTTON **x10 PAIRS**

- MATERIAL: 100% cotton.
- Flat cotton laces, 7 mm wide. Available in 2 colour versions and lengths: 100 cm (white and black) and 120 cm (black).

Code	Size [cm]	Colour	
L9040500	100		10/120
L9040520	120		10/120
L9040600	100		10/120

Each pair comes with a bar code

**4 FLAT SHOE LACES**

- ПЛОСКИЕ ШНУРКИ ДЛЯ БОТИНОК • FLACHE SCHNÜRSENKEL



100% POLYESTER **x10 PAIRS**

- MATERIAL: 100% polyester
- Flat shoelaces 9 mm wide. Available in 2 colour versions and with a standard length of 110 cm (+/-10 cm after stretching)

Code	Size [cm]	Colour	
L9040710	universal		10/120
L9040810	universal		10/120

Each pair comes with a bar code

# DECORATION OF CLOTHES

We know the importance  
of your brand



# EMBROIDERY OR PRINT?

Clothing is an important part of building an image. Employees represent their company, so their neat appearance, consistent with the company's visual identity, should be a concern of every employer who wants to develop their business. We offer comprehensive solutions, which allow us to permanently mark almost every item of clothing with logos or advertising slogans. We offer competitive prices, a wide selection of clothing and short lead times.



## EMBROIDERY

This is one of the noblest ways of decorating textiles. It is extremely durable, reliable and gives clothing a unique look. Computerised embroidery is used when decorating fleece clothing, blouses, shirts, hats, etc. This technique is perfect for adding graphic characters and any texts to textiles.



## THERMAL TRANSFER PRINTING

Flex and flock technology allows you to transfer simple graphics to cotton or polyester. The Flex is a smooth film, the flock is a film with a "short fibre" structure. The graphic design in vector form is cut from the film on a cutting plotter. The prepared film is transferred onto the material using a thermal transfer press.



## SUBLIFLOCK

The graphic is applied onto a special foundation, which is then transferred onto the material in a thermal transfer press. Subliflock makes it possible to obtain any tonal transitions and multi-coloured graphics. The surface of the finished decoration is covered with a delicate "short fibre" structure.



## SUBLIMATION

The sublimation method involves transferring any graphic onto bright polyester fabrics. The printed pattern is transferred using a thermal transfer press.



## REFLECTIVE BELTS

The thermal transfer method makes it possible to apply additional reflective elements on chosen parts of clothing. This solution improves safety and simultaneously increases the functional values of sweatshirts, jackets and trousers, which are used while working in limited visibility conditions.

# ORDER PROCESS

## STEP BY STEP

# 1.

Choose a product from the LAHTI PRO range or provide us with a different brand's products

LAHTI PRO workwear allows you to create a unique style. It underlines professionalism and increases competitiveness. Discover 1500 excellent products that can be freely combined and create your own original sets best suited to the nature of your work.



# ORDER PROCESS

## STEP BY STEP

# 2.

Suggest the location for the graphic design

Customers usually print on the following graphics:

- on the back  up to 25 cm
- sleeve  approx. 7 cm
- torso  8-10 cm
- pockets  approx. 10 cm
- trouser legs  up to 20 cm

Write or call us

# 3.

We need the following to fulfill your order:

- the code of the product we are to decorate
- your company's logo in vector form
- the size and location of the decoration/decorations
- the number of marked products

Before implementing the order, the ordering party receives a computer mock-up showing the text or graphic symbol on the clothing. It serves as the basis for final order acceptance.

Have any doubts? Our specialists are at your disposal. Call or write - we're here with suggestions and help.

# ДЕКОРАТИВНАЯ ОТДЕЛКА ОДЕЖДЫ

Мы знаем,  
как важна Ваша марка





# ВЫШИВКА ИЛИ ПЕЧАТЬ?

Одежда является важным элементом формирования имиджа. Сотрудники являются своего рода визитной карточкой компании, поэтому их аккуратный внешний вид, соответствующий визуальной идентификации предприятия, должен быть предметом заботы каждого работодателя, желающего развивать свой бизнес. Предлагаем комплексные решения, благодаря которым мы сможем закрепить логотипы или рекламные слоганы на почти каждом из предметов одежды. У нас - конкурентоспособные цены, широкий выбор одежды и сжатые сроки выполнения.



## ВЫШИВКА

Один из наиболее благороднейших способов декоративной отделки текстилей. Она необычайно прочна, надежна и придает одежде исключительный и неповторимый внешний вид. Компьютерная вышивка используется при декоративной отделке поларов, блуз, футболок, кепок и т.п. Эта техника идеальна для переноса на ткани графических знаков и произвольных надписей.



## ТЕРМОПЕРЕНОС

Технология флекс и флок позволяет переносить простую графику на хлопчатобумажные и полиэстровые ткани. Флекс - это гладкая пленка, флок - пленка с «мшистой» структурой. Графический проект в векторном виде вырезается из пленки на режущем плоттере. Подготовленная пленка втапливается в материал с помощью термотрансферного пресса.



## СУБЛИФЛОК

Графика наносится на специальную грунтовку, которая далее втапливается в материал с помощью термотрансферного пресса. Сублифлок позволяет получить любые тональные переходы и многоцветную графику. Готовая, декоративно обработанная поверхность покрыта деликатной, «мшистой» структурой.



## СУБЛИМАЦИЯ

Метод сублимации заключается в переносе произвольной графики на светлые полиэстровые нетканые материалы. Напечатанный узор втапливается с помощью термотрансферного пресса.



## СВЕТООТРАЖАЮЩИЕ ПОЛОСЫ

Метод термопереноса позволяет наносить дополнительные светоотражающие элементы на выбранные детали одежды. Такое решение повышает безопасность и вместе с тем улучшает пользовательские качества блуз, курток и штанов, используемые во время работы в условиях ограниченной видимости.

# ЗАКАЗ

## ШАГ ЗА ШАГОМ

# 1.

Выберите продукт из торгового предложения LANТИ PRO, либо доставьте нам продукты другой марки

Рабочая одежда LANТИ PRO позволяет создать неповторимый стиль. Подчеркивает профессионализм и повышает конкурентоспособность. Ознакомьтесь с 1500 doskonaльными продуктами, которые можно произвольно соединять и создавать свои собственные оригинальные комплекты, наилучшим образом отвечающие особенностям выполняемой работы.



# ЗАКАЗ

## ШАГ ЗА ШАГОМ

# 2.

Предложите место нанесения графики

Чаще всего клиенты наносят графику на:

- Спине ← до 25 см →
- Рукаве ← ок. 7 см →
- Грудь ← 8-10 см →
- Карманах ← ок. 10 см →
- Штанинах ← до 20 см →

Напишите либо  
позвоните

# 3.

Для реализации заказа нам будет необходимо:

- указать код продукта, на котором мы должны будем выполнить декоративную отделку
- доставить нам логотип компании в векторном виде
- указать размеры и место расположения декоративной отделки/отделок
- указать количество продуктов, которые следует маркировать

Перед началом реализации заказа заказчик получает выполненную компьютерной техникой визуализацию нанесенного на одежду графического знака либо надписи. На этом основании выполняется окончательное одобрение приема заказа.

У Вас возникли сомнения? Наши специалисты в Вашем распоряжении. Позвоните либо напишите - подскажем, поможем.

# DEKORATION VON KLEIDUNG

Wir wissen,  
wie wichtig Ihre Marke ist



# STICKEREI ODER DRUCK?

Kleidung ist ein wichtiges Element beim Aufbau des Image. Die Mitarbeiter sind das Aushängeschild des Unternehmens. Daher sollte ihr gepflegtes Erscheinungsbild, das der visuellen Identität des Unternehmens entspricht, jedem Arbeitgeber, der sein Unternehmen entwickeln möchte, ein Anliegen sein. Wir bieten umfassende Lösungen, durch die wir Logos oder Werbeslogans auf fast jedes Kleidungsstück permanent übertragen. Wir bieten wettbewerbsfähige Preise, eine große Auswahl an Kleidung und kurze Laufzeiten.



## STICKEREI

Ist eine der edelsten Arten, Textilien zu dekorieren. Sie ist extrem langlebig, zuverlässig und verleiht Kleidung ein einzigartiges und außergewöhnliches Aussehen. Computerstickerei wird zum Verzieren von Fleecesweatshirts, Sweatshirts, Hemden, Kappen usw. verwendet. Diese Technik ist ideal für die Übertragung von Grafikzeichen und beliebigen Texten auf Textilien.



## TERMOTRANSFER

Mit der Flex- und Flock-Technologie können Sie einfache Grafiken auf Baumwolle oder Polyester übertragen. Flex ist eine glatte Folie, Flock ist eine Folie mit "flaumiger" Struktur. Das Grafikdesign in Vektorform wird auf dem Schneideplotter aus der Folie ausgeschnitten. Die vorbereitete Folie wird mit einer Thermotransferpresse in das Material eingeschweißt.



## SUBLIFLOCK

Die Grafik wird auf ein spezielles Fundament aufgebracht, das anschließend mit einer Thermotransferpresse eingeschweißt wird. Mit Subliflock können Sie alle tonalen Übergänge und mehrfarbigen Grafiken erhalten. Die Oberfläche des fertigen Dekors ist mit einer feinen Struktur von "Flaum" bedeckt.



## SUBLIMATION

Bei der Sublimationsmethode werden beliebige Grafiken auf helle Polyesterstoffe übertragen. Das gedruckte Muster wird mit einer Thermotransferpresse eingeschweißt.



## REFLEKTIONSSTREIFEN

Mit der Thermo-Transfermethode können Sie zusätzliche reflektierende Elemente auf ausgewählte Teile der Kleidung auftragen. Eine solche Lösung verbessert die Sicherheit und erhöht gleichzeitig die funktionalen Werte von Sweatshirts, Jacken und Hosen, die beim Arbeiten bei eingeschränkter Sicht verwendet werden.

# DIE BESTELLUNG SCHRITT FÜR SCHRITT

1.

Wählen Sie ein Produkt aus dem Angebot von LAHTI PRO oder liefern Sie Produkte einer anderen Marke an uns

Mit LAHTI PRO Arbeitskleidung können Sie einen einzigartigen Stil kreieren. Betont Professionalität und steigert die Wettbewerbsfähigkeit. Entdecken Sie 1500 hervorragende Produkte, die sich frei kombinieren lassen, und erstellen Sie Ihre eigenen Originalsets, die den Eigenschaften Ihrer Arbeit am besten entsprechen.



# DIE BESTELLUNG SCHRITT FÜR SCHRITT

## 2.

Schlagen Sie eine Stelle für die Grafik vor

Kunden drucken normalerweise Grafiken auf:

- Rücken  bis zu 25 cm
- Ärmel  ca. 7 cm
- Brust  8-10 cm
- Taschen  ca. 10 cm
- Beine  bis 20 cm

Schreiben oder rufen Sie

## 3.

Für die Bearbeitung der Bestellung benötigen wir:

- Angabe des Produktcodes, auf dem wir verzieren sollen
- Bereitstellung eines Vektor-Firmenlogos
- Angabe der Größe und Lage der Dekoration / Dekorationen
- Angabe der Anzahl der gekennzeichneten Produkte

Vor Beginn der Bestellung erhält der Besteller eine computergestützte Visualisierung mit der Aufschrift oder dem Grafiksymbol auf der Kleidung. Auf dieser Basis erfolgt die endgültige Annahme der Bestellung.

Haben Sie Zweifel? Unsere Experten stehen Ihnen zur Verfügung. Rufen Sie an oder schreiben Sie uns - wir geben Tipps, wir helfen.



Labor Code

**“The employer must not allow an employee to work without personal protective equipment and occupational clothing or footwear intended for a given work station”**  
 (Labor Code, Article 2379(1))

**“The employer is obliged to provide employees with personal protective equipment that meet conformity evaluation conditions under separate provisions”**  
 (Labor Code, Article 2376(3))

**LEGAL BASIS**

**Regulation (EU) 2016/425 of the European Parliament and of the Council of 9 March 2016 on personal protective equipment and repealing Council Directive 89/686/EEC.**

In accordance with the law of the European Union (Directive 89/686/EEC of 21 December 1989, regarding personal protective equipment, Regulation of EP and of the EU Council 2016/425 of 9 March 2016 on personal protective equipment and repealing Council Directive (89/686/EEC) and national provisions on the safety and health and the Labor Code, every employer is obliged to supply their employees with personal protective equipment that will be adequate to protect them against any risks at their respective work stations.

**“Personal protective equipment is a unit or equipment intended for wearing or holding by a user for protection against one or more risks that may affect the safety or health of the user.”**

**Personal protective equipment**

is a quite a broad concept. It is not only intended for protection of employees on their work stations, but also applies to applications not related to work, such as sports or leisure. It may also include: visibility accessories and protective high-

visibility clothing for non-professional use. Before placing personal protective equipment on the market, its manufacturer must demonstrate, as a result of conformity assessment, that it conforms to the essential safety and health requirements, specified in Regulation 2016/425. One way to demonstrate compliance of personal protective equipment with the essential requirements is proving that it meets the requirements of a standard harmonized with the above-mentioned Directive.

Harmonized standards are European Standards drafted by European standardization organizations. They conform to essential requirements of EU directives and regulations and are the easiest way for the manufacturer or importer to demonstrate presumed conformity of the product with a relevant directive or regulation. In order to confirm that personal protective equipment meets the essential requirements, the manufacturer labels it with a CE mark and issues a declaration of conformity to the PPE Regulation and harmonized standards.



**CATEGORIES OF PERSONAL PROTECTIVE EQUIPMENT**

The PPE Regulation divides personal protective equipment into three protection categories, depending on the level of risk that an employee may be exposed to during work:

Risk category	Risk level	Description
I	Low	Products in this category provide the basic level of protection against low-risk external factors, the effects of which are superficial, protecting against e.g minor cuts, abrasions, dirt, mild cleaning agents, mild atmospheric agents, contact with hot surfaces not exceeding 50°C, damage to the eyes due to exposure to sunlight (other than during observation of the sun), etc.
II	Medium	Products in this category are used for protection in conditions where the level of risk has not been classified as low or high.
III	High	Category III includes exclusively the risks that may cause very serious consequences such as death or irreversible damage to health relating to substances and mixtures which are hazardous to health, atmospheres with oxygen deficiency, harmful biological agents, ionizing radiation, high-temperature environments the effects of which are comparable to those of an air temperature of at least 100°C, low-temperature environments the effects of which are comparable to those of an air temperature of -50°C or less, falling from a height, electric shock and live working, drowning, cuts by hand-held chainsaws, high-pressure jets, bullet wounds or knife stabs, harmful noise, etc.

PROLINE  
LAHTI PRO  
MEGA  
JUCO  
OTHER BRANDS  
ERDI  
KLINGSPOR  
EXPRESS  
ACTION CAN  
TRYTON  
VULCAN



**Before selecting proper PPE:**

- define the risk level
- specify the type of hazard
- determine the kind of hazard
- select a product with specified protection parameters

Division of PPE into groups:



# EYE AND FACE PROTECTION

Equipment for eye and face protection prevents damage to eyes and face caused by mechanical, chemical, biological, and thermal factors as well as harmful radiation.

Equipment for eye and face protection for professional applications should be used wherever the following hazards exist:

Equipment for eye and face protection for professional use is divided into three categories:



impact (such as spatter)



liquid droplets and splashes (such as splashes when pouring liquids)



optical radiation (such as radiation during welding, sun glare)



melted metals and hot solids (such as molten metal splashes during metallurgical processes)



dusts and gases (such as coal dust or aerosols of harmful chemicals)



electric arc (such as produced during live works)



Goggles and safety glasses



Face shields



Welding guards (this category includes shields, goggles, and welding hoods)



## LIST OF STANDARDS:

**EN 166** – Personal eye protection – Specifications. The standard specifies requirements for various types of personal protective equipment for eyes.

**EN 169** – Personal eye protection – Filters for welding and related techniques. Transmittance requirements and recommended use. This standard provides markings and transmittance requirements for filters intended for the protection of operators performing work that requires welding, arc-air gouging, and plasma cutting.

**EN 170** – Personal eye protection – Ultraviolet – Transmittance requirements and recommended utilization. This standard includes the principles for marking, identification, selection, and use of filters. This standard specifies the transmittance requirements for filters protecting against ultraviolet radiation.

**EN 172** - Personal eye protection – Sun glare filters for industrial use. This standard specifies the criteria for selection, marking, and transmittance and establishes proper test methods for sun glare filters.

**EN 1731** – Personal eye protection – Mesh eye and face protectors. This standard specifies the materials, design method, requirements, test methods and marking of mesh eye and face protectors protecting against mechanical hazards.

**EN 175** – Personal protection – Equipment for eye and face protection during welding and allied processes. This standard specifies the requirements regarding safety and test methods for PPE used for eye and face protection against optical radiation and other specific sources of risk or threat usually present during welding, cutting, or allied processes.

PROLINE  
LAHTI PRO  
MEGA  
JUCO  
OTHER BRANDS  
ERDI  
KLINGSPOR  
EXPRESS  
ACTION CAN  
TRYTON  
VULCAN

## GOGGLES AND SAFETY GLASSES

Marking of safety glasses and goggles is used to identify them and ensure the correct selection regarding hazards at the given work station.

**Lenses** (oculars) and **frames** (mountings) are marked separately. However, if they constitute a whole, all the required marking symbols should be on a frame (mounting).

### MARKING OF GOGGLES AND SAFETY GLASSES



CE 5-3.1 XX 1 FT

#### MARKING OF LENSES

- CE mark
- filter type (from 2 to 6)
- shade (from 1.2 to 16)
- identification mark of the manufacturer
- optical class (from 1 to 3)
- mechanical strength symbol ("S", "F", "B", "A")
- additional protection features symbol ("K", "N", "R", "T")

#### MARKING OF FRAMES



CE XX EN 166 F

- CE mark
- identification mark of the manufacturer
- standard No.
- mechanical strength symbol ("S", "F", "B", "A")

#### Filter type Radiation protection:

2	ultraviolet filter (UV)
2C or 3	ultraviolet filter (UV), good color recognition
4	infra-red filter (IR)
5	sun glare filter (sunscreen) without any infra-red requirements
6	sun glare filter (sunscreen) with infra-red requirements

#### Shade Light transmission factor

1.2	100 – 74.4 %
1.4	74.4 – 58.1%
1.7	58.1 – 43.2%
2.0	43.2 – 29.1%
2.0	43.2 – 29.1%
2.5	29.1 – 17.8%
3.1	17.8 – 8.0%
4.1	8.0 – 3.0%
...	
16	0.000061 – 0.000023%

#### Optical class:

- 1 for continuous use
- 2 for intermittent use
- 3 for occasional use

#### Mechanical strength symbols:

- S** increased impact energy – resistance to impact by a 43 g steel ball with a nominal diameter of 22 mm at the speed of 5.1 m/s
- F** low impact energy – resistance to impact by a 0.86 g steel ball with a nominal diameter of 6 mm at the speed of 45 m/s
- B** medium impact energy – resistance to impact by a 0.86 g steel ball with a nominal diameter of 6 mm at the speed of 120 m/s
- A** high impact energy – resistance to impact by a 0.86 g steel ball with a nominal diameter of 6 mm at the speed of 190 m/s (for face shields)

#### Fields of use (for goggles)

- 3 resistant to liquid (in the form of droplets or splashes)
- 4 resistant to coarse dust particles (larger than 5 µm)
- 5 resistant to gas and fine dust particles (vapors, fogs, fumes and dusts with particle size smaller than 5 µm)
- 8 resistant to short circuit electric arc
- 9 resistant to molten metal and penetration by hot solids

#### Additional protection feature symbols:

- K** resistant to surface damage by fine dust particles
- N** resistant to fogging
- R** increased reflection coefficient
- T** resistant to particles in extreme temperatures. Guaranteed resistance interval -5°C – 55°C

### EYE AND FACE PROTECTION CLASSES – MECHANICAL INJURIES

PARAMETER	SAFETY GLASSES	GOGGLES	FACE SHIELD
Increased impact resistance (5.1m/s) – mark S	+	+	+
Low-energy impact resistance (45 m/s) – mark F	+	+	+
Medium-energy impact resistance (120 m/s) – mark B	-	+	+
High-energy impact resistance (190 m/s) – mark A	-	-	+

FACE SHIELD

Face shields protect the whole face. Their large surface minimizes the risk of hazardous liquid splatter reaching the inside of the shield. Face shields can be used in combination with glasses (safety or corrective), goggles, and some types of respiration protection.

Shields are mounted directly on the head of a user or a protective helmet. Lenses of such shields are usually made of mass-dyed polycarbonate or polycarbonate coated with layers reflecting thermal radiation, used wherever thermal radiation is particularly high.

MARKING OF FACE SHIELDS



- manufacturer identification, model mark
- standard No.
- optical class
- mechanical resistance
- resistant to high-speed impact
- resistant to liquid splashes
- CE mark

MARKING OF WELDING SHIELDS



- manufacturer identification, model mark
- standard No.
- CE mark

WELDING SHIELDS

Welding helmets and welding hand shields are used during electric arc welding, arc-air gouging, oxycutting, and plasma arc cutting. Welding helmets may be equipped with a single welding filter or two welding filters, one of which is a filter used only for observation, and the other a proper, darker filter used for observation of the welding process.

Welding helmets with automatic welding filters are also used. Such filters dim the field of vision automatically during e.g. electric or plasma arc observation. After the arc is gone (in weld cooling rate), they automatically brighten the field of vision. Welding helmets may be additionally equipped with a ventilation system, supplying air from the back of the welder's head, which significantly reduces the amount of the inhaled welding fumes (dusts and gases) produced during welding or may be equipped with brackets for filtering devices with forced air flow.

The welding hand shield protects the eyes, entire face, and neck of the welder. The basic limitation of the welding hand shield is the necessity to hold it in the hand during welding, which significantly reduces the freedom of movement of the operator and makes it impossible to hold down the welded object, for example.

Selection of welding filter conforming to EN169/EN175

PROCESS	CURRENT [A]																					
	1.5	6	10	15	30	40	60	70	100	125	150	175	200	225	250	300	350	400	450	500	600	
Covered electrodes	8			9			10			11			12			13			14			
MAG	8			9			10			11			12			13			14			
TIG	8			9			10			11			12			13			14			
MIG heavy metals	8			9			10			11			12			13			14			
MIG light alloys	8			9			10			11			12			13			14			
Arc-air gouging	8			9			10			11			12			13			14			
PAC	8			9			10			11			12			13			14			
PAW	4	5	6	7	8	9	10	11	12	13	14	15	16	17	18	19	20	21	22	23	24	25

- **MIG** – welding using a consumable electrode shielded by inert gas
- **MAG** – welding using a consumable electrode shielded by active gas
- **TIG** – welding using a tungsten electrode shielded by inert gas
- **Arc-air gouging** – with the use of a carbon electrode and compressed air for blowing off molten metal
- **PAC** – plasma arc cutting
- **PAW** – plasma arc welding

# HEAD PROTECTION

## MARKING OF HELMETS

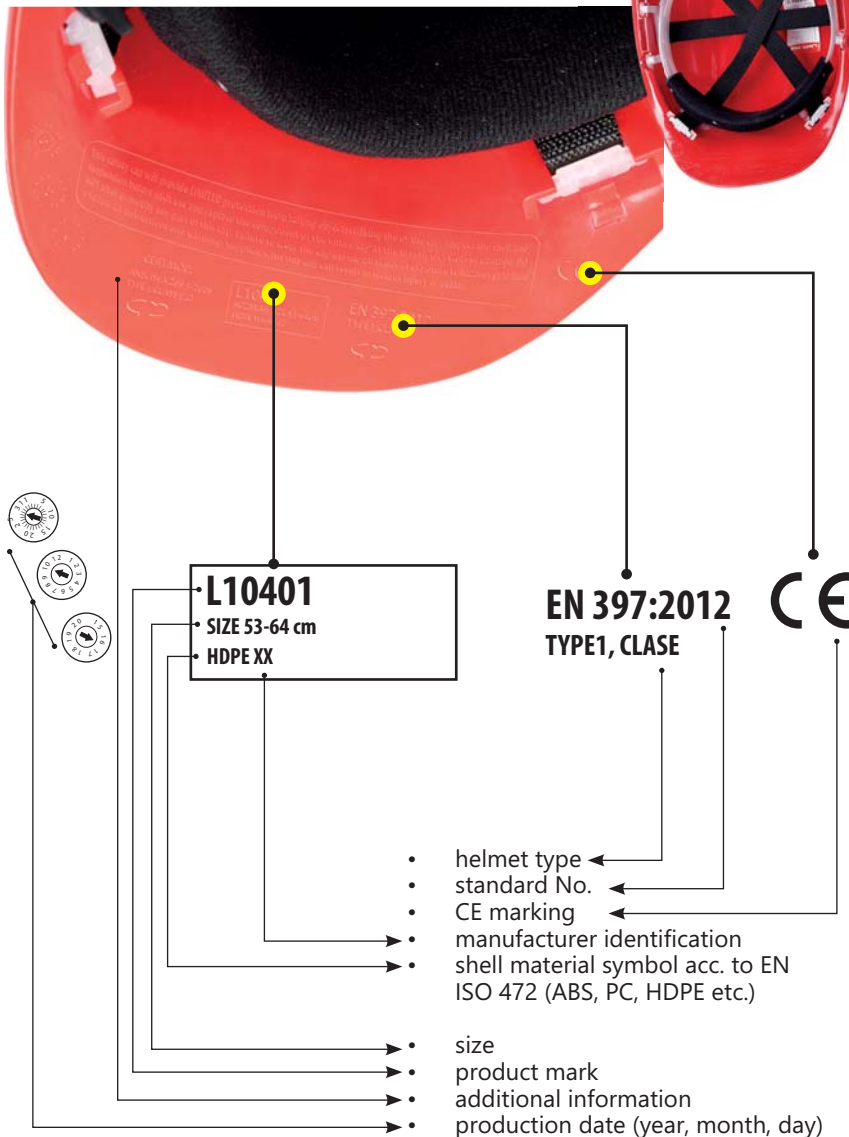

### LIST OF STANDARDS

**EN 397** – Industrial safety helmets. This standard specifies the structural requirements and safety-relevant parameters, test methods, and marking requirements for industrial safety helmets. Mandatory and additional requirements for safety-related parameters have been established.

#### Mandatory requirements

- **shock absorption** (impact energy transmitted to a headform may not exceed 5 kN during free-fall of a 5 kg striker from the height of 1 m)
- **resistance to penetration** (a 3 kg punch from the height of 1 m may not deform the helmet in such a way, so as to touch the headform)
- **flame resistance** (burner flame at an angle of 45 degrees should be at a distance from 50 to 100 mm and come in contact with the top of the shell for 10 s. The helmet shell may not burn and spread fire for longer than 5 s after it is discontinued)

#### Additional requirements:

- shock absorption in very low temperatures –20°C or –30°C
- shock absorption in a very high temperature +150°C
- electrical insulation – 440 Vac
- longitudinal deformations – LD
- molten metal splashes – **MM**

### Helmet durability

Helmet production date is embossed on the internal side of the shell (most often on the brim). It is encoded in the form of three shields. The head of the arrow located in each shield indicates the year, month, and day of production, respectively. The helmet retains full protective properties for 2 years from the date of entry into use, not longer than 3 years from the production date.

# HEARING PROTECTION

### LIST OF STANDARDS

**EN352-1** - Hearing protectors – General requirements – Part 1: Earmuffs. This standard specifies the requirements regarding the structure, design, operation, marking, and information for the user of earmuffs

**EN352-2** – Hearing protectors – General requirements – Part 2: Earplugs. This standard specifies the requirements regarding the structure, design, operation, marking, and information for the user of earplugs.

**EN352-3** – Hearing protectors – General requirements – Part 3: Earmuffs attached to industrial safety helmets. This standard specifies the requirements regarding the structure, design, operation, marking, and information for the user of earmuffs attached to industrial safety helmets.

### Basic parameters of the EN352 standard

- **adjustment** – the possibility to adjust the earmuffs to heads with various sizes is evaluated
- **headband pressure** – the maximum headband pressure is 14 N
- **cushion pressure** – the maximum pressure of the noise reduction cushions is 4,500 Pa
- **resistance to damage** – the product is dropped from the height of 1.5 meter onto a steel plate
- **flammability** – product surface is touched with a rod heated to 650°C ± 20°C for 5 seconds; the surface must not ignite or glow after the withdrawal of the bar.

### REQUIREMENTS OF DIRECTIVE 2003/10/EC

The minimum requirements for the protection of workers from risks related to exposure to noise

Exposure over 8 hours to $\geq 85$ dB	Exposure over 8 hours to $\geq 80$ dB	Exposure over 8 hours to $> 70$ dB and $\geq 80$ dB
Hearing protectors mandatory	Hearing protectors made available to the employee	Hearing protectors recommended



Hearing protectors are the simplest and fastest hearing protection method against effects of noise

### Hearing protectors are divided into:

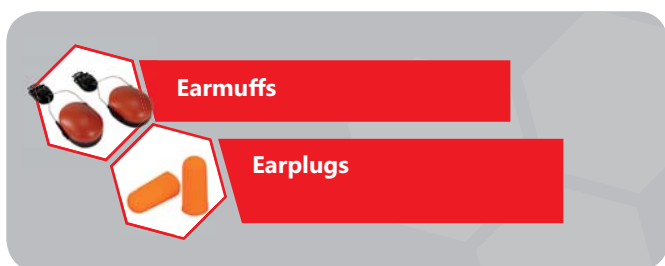

### ATTENUATION

**SNR**

(Simplified Noise Reduction)  
Unit average noise reduction value.

**HML**

Noise reduction value expressed depending on the average frequency

**H:** Attenuation of high frequencies (high tones)

**M:** Attenuation of medium frequencies

**L:** Attenuation of low frequencies (low tones)

### NOISE-PROTECTION EARMUFFS

Earmuffs are made of two noise reduction bowls that cover the auricle and pressed tightly against the head with soft sealing cushions, usually filled with plastic foam or liquid. Damping bowls are usually filled with sound absorbing material. Earmuffs may be worn separately or mounted on safety helmets.

### EARPLUGS

Earplugs are hearing protectors worn in the external auditory canal. They are intended for tight closing of the auditory canal. Earplugs come in two types: disposable and reusable plugs. They may be shaped by the manufacturer (e.g. made of silicone) or by the user (e.g. made of foam). Earplugs are also available in a headband version. The headband acts as a pressure spring and is used for maintaining the plug inside or at the entry point to the auditory canal. The headband may be worn on the top of the head, under the chin or at the back of the head. The size of the plugs should be carefully selected for every user, since ill-suited plugs may cause discomfort or irritation of the auditory canal.



### MARKING OF EARPLUGS

Due to the nature of the product, marking of ear plugs should be fixed on the packaging or dispenser.

- wearing and use instructions
- sizes
- standard No.
- CE mark

### EARMUFF MARKING

- identification mark of the manufacturer
- CE mark
- standard No.
- designation front/back, up/down if the arrangement of the bowls is important

# RESPIRATORY PROTECTION

## MARKING OF HALF MASKS



- CE mark and notified body No.
- positive test result for dolomite dust clogging
- designation of reusability (NR – non-reusable; R – reusable)
- individual product number
- standard No.
- production date
- model designation
- protection class
- name of manufacturer

### LIST OF STANDARDS

**EN149:2001** Respiratory protective devices – Filtering half masks to protect against particles – Requirements, testing, marking. This standard applies to filtering half masks classified in protection category III. It specifies the minimum requirements for tests and marking of filtering half masks used as respiratory protection against particles, except for masks used in the case of emergence egress.

**MAC** – the maximum allowable concentration of a toxic chemical compound or different harmful factor the impact of which on an employee over an 8-hour a day average weekly working time specified in the Labor Code, within the period of their professional activity should not cause any negative changes in their health condition.

### USING RESPIRATORY PROTECTION DURING WORK IS REQUIRED WHEN

- the concentration of hazardous substances in the air exceeds the Maximum Allowable Concentration (MAC) for these substances
- the oxygen content in the breathed air is lower than 17% of its composition
- the temperature of the breathed air exceeds the acceptable standard for a temperature, in which a person may work

Filtering half masks are divided by filtering efficiency into three classes: **FFP1, FFP2, and FFP3.**

Filtering efficiency for every class

	FFP1	FFP2	FFP3
Concentration of harmful substances	up to 4xMAC	up to 10xMAC	up to 30xMAC
Filtering efficiency	80%	94%	99%
Leakage	20%	6%	1%
Initial breathing resistance at 95 l/min	<210 Pa	<240 Pa	<300 Pa

# HAND PROTECTION

Protective gloves are an extremely important element of PPE used for protection of hands against factors that are unwanted and/or harmful to the health and life.

Properly selected protective gloves will not only provide adequate hand protection but also guarantee the maximum comfort of use and a positive impact on the safety and quality of the performed work.



PROLINE

LAHTI PRO

MEGA

JUCO

OTHER BRANDS

ERDI

KUNGSFOR

EXPRESS

ACTION CAN

TRYTON

VULCAN



## HOW TO CHOOSE PROTECTIVE GLOVES

### Size

The table below presents the guidelines of the **EN 420** standard regarding the specific glove sizes assigned to individual palm sizes. Lahti Pro protective gloves provide the user with the optimum fit and guarantee both safety and great comfort of use.

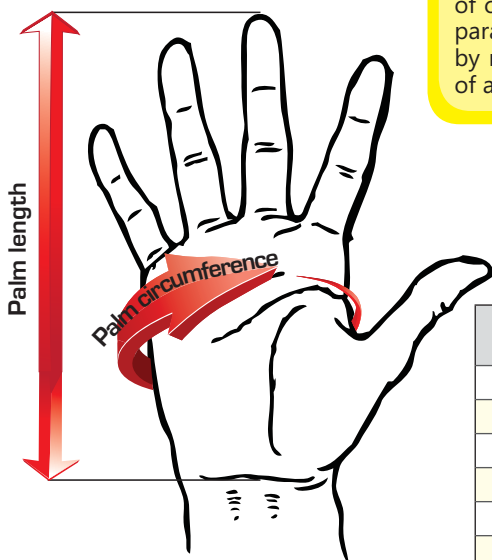

### LIST OF STANDARDS

#### EN 420

- **Protective gloves** – General requirements and test methods. This standard applies to all the protective gloves, regardless of protection category, to which the gloves belong (hence it applies to protection class I, II, and III). It specifies the general requirements and adequate testing procedures applicable to design and structure of gloves, resistance of their material to water penetration, their safety, comfort of use and their efficiency, marking, and information provided by the manufacturer that apply to all types of protective gloves.

#### EN 388 – Protection gloves against mechanical risks.

This standard applies to protective gloves belonging to protection category II. It includes the requirements, test methods, marking, and information provided to the user. Glove tests include resistance to mechanical damage, such as abrasion, cutting with a sharp blade, tear and puncture. Mechanical resistance parameters for gloves are specified by means of four digits at the bottom of a graphic symbol.

#### EN 407 – Protective gloves against thermal risks (heat and/or fire).

This standard applies to protective gloves belonging to protection category II. It includes the general requirements, test methods, levels of efficiency within the scope of thermal resistance, marking, and information provided to the user. Glove tests include resistance to thermal risks such as fire or high temperature. Thermal resistance parameters for gloves are specified by means of six digits at the bottom of a graphic symbol.

#### EN 511 – Protective gloves against cold.

This standard applies to protective gloves belonging to protection category II. It includes the requirements for marking and information provided to the user, as well as tests of gloves protecting against convection and conducting of cold up to -50°C. Thermal resistance parameters for the gloves are specified by means of three digits at the bottom of a graphic symbol.

#### EN ISO 10819 – Mechanical vibration and shock

– Hand-arm vibration – Method for the measurement and evaluation of the vibration transmissibility of gloves at the palm of the hand. This standard applies to protective gloves belonging to protection category II. It includes the requirements for marking and information provided to the user, as well as specifies laboratory measurement method and the method for data analysis and preparation of a test report for the vibration transmissibility of gloves with material reducing vibrations that cover palm of the hand and fingers together with the thumb. According to the established test procedure for the gloves suggested for the protection against vibration, two numeric coefficients characterizing the gloves have been determined:

- corrected vibration transmissibility TRM for the M test signal (frequency range 32–200 Hz)
- corrected vibration transmissibility TRH for the H test signal (frequency range 200–250 Hz)

#### EN 12477 – Protective gloves for welders.

This standard applies to protective gloves in protection category II. It includes the requirements on marking and information provided by the manufacturer and tests of welding gloves used in manual metal welding, cutting, and in allied processes. In accordance with the above-mentioned standard, protective gloves for welders are divided into the following groups:

- A type (ensure fulfillment of requirements within the scope of protective qualities at a higher level)
- B type (used for work that requires great skill, e.g. during TIG welding)

#### EN381-7 – Requirements for chainsaw protective gloves.

Requirements concerning protective gloves used to protect the user when operating hand-held chainsaws were specified. Two designs of gloves protecting from chainsaw cutting were defined, i.e. design A and design B. Requirements concerning resistance to chainsaw cutting, to mechanical factors, ergonomics and marking, manufacturer information, and operating instructions were set out. Tips for selecting the appropriate protective glove design were included as well. Protection from chainsaw cutting divides the gloves into four classes depending on the chainsaw chain speed: Class 0 – 16 m/s, Class 1 – 20 m/s, Class 2 – 24 m/s, and Class 3 – 28 m/s.

Size	Palm length	Palm circumference
6 [XS]	16.0 cm	to 15.2 cm
7 [S]	17.1 cm	to 17.8 cm
8 [M]	18.2 cm	to 20.3 cm
9 [L]	19.2 cm	to 22.9 cm
10 [XL]	20.4 cm	to 25.4 cm
11 [2XL]	21.5 cm	to 27.9 cm



**EN388**  
abcDEF

Parameter	Level 1	Level 2	Level 3	Level 4	Level 5	
(a) Abrasion resistance (number of cycles)	100	500	2000	8000	-	
(b) Cut resistance (index)	1.2	2.5	5.0	10.0	20.0	
(c) Tear resistance [N]	10	25	50	75	-	
(d) Puncture resistance [N]	20	60	100	150	-	
Parameter	Level A	Level B	Level C	Level D	Level E	Level F
(e) Cut resistance acc. to ISO 13977 [N]	2	5	10	15	22	30
Parameter	Level P					
(f) Impact resistance acc. to EN 13594:2015	YES					

Parameters a-d acc. to EN 388:2002; parameters a-f acc. to EN 388:2016

**EN407**  
abcDEF

Parameter	Level 1	Level 2	Level 3	Level 4
(a) Burning behavior				
After-burn time [s]	≤ 20	≤ 10	≤ 3	≤ 2
After-glow time [s]	No requirements	≤ 120	≤ 25	≤ 5
(b) Resistance to contact heat				
Contact temperature Tc [°C]	100	250	350	500
Threshold time tt [s]	≥ 15	≥ 15	≥ 15	≥ 15
(c) Resistance to convection heat				
Heat transfer index HTI [s]	≥ 4	≥ 7	≥ 10	≥ 18
(d) Radiant heat resistance	20	60	100	150
Heat transfer t24 [s]	≥ 7	≥ 20	≥ 50	≥ 95
(e) Resistance to fine molten metal splashes				
Number of droplets	≥ 10	≥ 15	≥ 25	≥ 35
(f) Resistance to large amount of molten metal				

**EN12477**

Properties	Requirements	
	A type	B type
Abrasion resistance - level of efficiency (in the number of cycles)	2 (500)	1 (100)
Cut resistance - level of efficiency (I index)	1 (1.2)	1 (1.2)
Tear resistance - level of efficiency (value in N)	2 (25)	1 (10)
Puncture resistance - level of efficiency (value in N)	2 (60)	1 (20)
Burning behavior - level of efficiency	3 (after-burn time ≤ 3 s, after-glow time ≤ 25 s)	2 (after-burn time ≤ 3 s, after-glow time ≤ 25 s)
Contact heat resistance - level of efficiency (contact temp. in °C)	1 (100)	1 (100)
Resistance to fine splashes of molten metal - level of efficiency (number of droplets)	2 (≥7)	no requirements
Dexterity - level of efficiency (rod diameter in mm)	1 (11)	4 (6.5)

**EN511**  
abc

Parameter	Level 1	Level 2	Level 3	Level 4
(a) Thermal insulation				
Thermal insulation ITR [m2K/W]	0.10 ≤ ITR < 0.15	0.15 ≤ ITR < 0.22	0.22 ≤ ITR < 0.30	0.30 ≤ ITR
(b) Thermal resistance				
Thermal resistance R [m2K/W]	0.025 ≤ R < 0.050	0.050 ≤ R < 0.100	0.100 ≤ R < 0.150	0.150 ≤ R

C – Parameter – resistance to water penetration – 0 or 1

**Coating/grip material**

**“WORKSHOP” GLOVES MADE OF SYNTHETIC LEATHER**

Synthetic leather is a material characterized by durability and resistance to wear. Gloves made of synthetic leather typically have numerous reinforcements, cushions protecting against calluses and vibration, and a Velcro wrist strap.

Durability, comfort of use, and extra feel of the held object make the gloves a popular tool in car workshops and therefore are widely known as workshop gloves. However, they are also very popular in the transportation industry, in warehouses, and all kinds of leisure activities.

**NATURAL LEATHER GLOVES**

The gloves made of natural leather exhibit high resistance to abrasion and tear. They are also distinguished by their good breathability. They provide the maximum comfort of use and good grip of the held object, satisfying even the most discerning users. Due to their wide array of applications, natural leather gloves are used in many sectors, such as construction, transportation, automotive, and agriculture.

**LATEX-COATED GLOVES**

Latex is most popular coating of protective gloves. The gloves are coated with latex or made of it. They are characterized by high flexibility, also in low temperatures, high resistance to tear, and provide excellent performance even in the most difficult weather conditions. Great versatility of latex, as well as relatively low production cost mean that latex gloves are used at construction sites, in the transportation industry, agriculture, households, gardens and many other domains.

**INSULATED GLOVES**

Insulated gloves are intended for work in difficult weather conditions, including in low temperatures. Their coating provides them with versatility. A mix of synthetic fibers that don't absorb water and keep warmth inside protect the user against cold, rain, snow, and wind. Insulated gloves are used at construction sites, in the transportation industry, and in coolers.



**NITRILE-COATED GLOVES**

Nitrile, from which the gloves of the Lahti Pro brand are made, is a synthetic rubber mixture of acrylonitrile and butadiene that contains no latex proteins. The combination of these two components produces a flexible material that is very resistant to abrasion, at the same time providing excellent resistance to unleaded petrol, diesel oil, hexane and paraffin. It also provides ideal protection against oils and greases. Nitrile-coated gloves are often used in the transportation and automotive industry, as well as in agriculture and gardening. They are also an excellent alternative for latex-sensitive people.

**POLYURETHANE-COATED GLOVES**

Polyurethane is a material with very high flexibility and great resistance to abrasion and tear. Thanks to these properties, it is perfect for production of gloves with a thin and at the same time very resistant coating. Polyurethane gloves provide excellent dexterity and feel of the held object, ensuring great performance especially during works that require high precision. These gloves are often used by mechanics, warehouse operatives, and homeowners.

**PVC-COATED GLOVES**

PVC-coated gloves are characterized by excellent resistance to greases, oils, fats, mild cleaning agents, as well as water, also providing relatively good performance in low temperatures. They are used in many sectors, including automotive, agriculture, and transportation.



**Properties of coating/grip materials**

Coating properties	Type of coating/grip					
	Synthetic leather*	Natural leather	Latex	Nitrile	Polyurethane (PU)	PVC
Elasticity	1	1	5	4	5	3
Non-slip properties	1	2	4	5	3	5
Grip (feel of the held object)	5	4	3	4	5	3
Abrasion resistance	5	5	2	5	5	4
Tear resistance	5	5	5	1	5	1
Puncture resistance	5	5	2	5	2	3
Resistance to water and its derivatives	1	2	5	3	3	5
Resistance to greases and oils	2	3	2	5	4	5
Hydrocarbon resistance	1	1	1	4	1	2
Resistance to washing agents and detergents	1	1	5	4	4	5
Resistance to ketone solvents	1	1	4	1	2	1

1 Very low   
 2 Low   
 3 Medium   
 4 High   
 5 Very high

\*The grip of many models of Lahti Pro synthetic leather gloves has numerous PVC reinforcement inserts, non-slip silicone mesh, etc., which significantly improve glove performance. Information in the table above applies to synthetic leather only and hence does not include properties of additional materials.

**Note:** The table above constitutes illustrative comparison of the properties characteristic for specific types of coating/grip sections of the gloves. The properties of the coating/grip section may differ, depending on the glove model.



**Type of fabric from which the gloves should be made**

The table below shows the main advantages of the fabrics used in protective gloves:

Type of fabric	Advantages	
Polyester	<ul style="list-style-type: none"> <li>Can be mixed with cotton to increase the comfort of use</li> </ul>	<ul style="list-style-type: none"> <li>Liquid penetration resistant</li> </ul>
	<ul style="list-style-type: none"> <li>Strong and durable</li> <li>Resistant to abrasion and stretching</li> </ul>	<ul style="list-style-type: none"> <li>Fast-drying</li> <li>Elastic</li> </ul>
Cotton	<ul style="list-style-type: none"> <li>Highly breathable, cool, transfers heat</li> <li>Soft to the touch (very comfortable)</li> </ul>	<ul style="list-style-type: none"> <li>Absorbs sweat</li> <li>No static electricity</li> </ul>
	<ul style="list-style-type: none"> <li>Abrasion resistant</li> </ul>	
Nylon	<ul style="list-style-type: none"> <li>Strong and durable</li> <li>Very resistant to abrasion and stretching</li> </ul>	<ul style="list-style-type: none"> <li>Liquid penetration resistant</li> <li>Elastic</li> </ul>
	<ul style="list-style-type: none"> <li>Resistant to oils, fats, and petrol</li> </ul>	
Acrylic	<ul style="list-style-type: none"> <li>Perfect protection against cold</li> </ul>	<ul style="list-style-type: none"> <li>Abrasion and stretch resistant</li> </ul>
	<ul style="list-style-type: none"> <li>Soft to the touch (very comfortable)</li> </ul>	<ul style="list-style-type: none"> <li>Oil resistant</li> </ul>
	<ul style="list-style-type: none"> <li>Liquid penetration resistant</li> </ul>	
Modified synthetic fiber	<ul style="list-style-type: none"> <li>Highly resistant to cuts</li> </ul>	<ul style="list-style-type: none"> <li>Liquid penetration resistant</li> </ul>
	<ul style="list-style-type: none"> <li>Very resistant to abrasion and stretching</li> </ul>	<ul style="list-style-type: none"> <li>Elastic</li> </ul>

PROLINE  
 LAHTI PRO  
 MEGA  
 JUCO  
 OTHER BRANDS  
 ERDI  
 KLINGSPOR  
 EXPRESS  
 ACTION CAN  
 TRYTON  
 VULCAN

# BODY PROTECTION

## MARKING OF PROTECTIVE CLOTHING

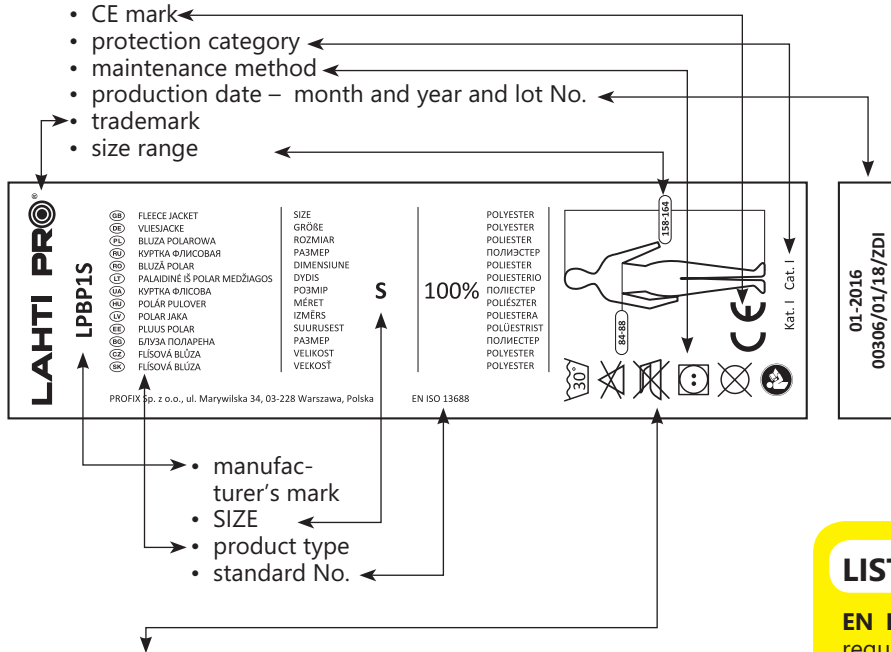

## SIZE

C – chest width  
W – waist  
H – height

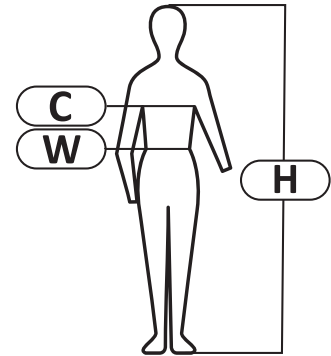

SYMBOL	DESCRIPTION
	Do not wash
	Hand wash
	Wash in 30°C – normal process
	Wash in 30°C – mild process
	Wash in 30°C – very mild process
	Do not iron
	Iron in up to 110°C
	Iron in up to 150°C
	Iron in up to 200°C
	Do not tumble dry
	Can be tumble dried – lower temperature
	Can be tumble dried – normal temperature
	Line dry
	Air dry
	Drip dry
	Do not dry clean
	Professional dry cleaning in perchloroethylene
	Do not bleach

## LIST OF STANDARDS

**EN ISO 13688 - Protective clothing** – General requirements. This International Standard specifies the general performance requirements for design, ergonomics, innocuousness, size designation, aging, compatibility, and marking of protective clothing and the information to be supplied by the manufacturer with the protective clothing. This International Standard is only intended to be used in combination with other standards containing requirements for specific protective performance and not on a stand-alone basis.

**EN ISO 20471 – High visibility clothing** – Test methods and requirements. This standard specifies the requirements for high visibility clothing which is capable of visually signaling user's presence. The high visibility clothing is intended to provide conspicuity of the wearer in any light condition when viewed by operators of vehicles or other mechanized equipment during daylight conditions and under illumination of headlights in the dark. This standard clearly specifies requirements for color and retroreflection as well as for the minimum areas and for the placement of the materials in protective clothing. In addition, it imposes the obligation to inform the user about the maximum number of cycles and the washing method recommended for the clothing in order to maintain the proper level of protection

### EN ISO 20471

This standard maintains the classification of clothing into 3 categories based on the minimum surfaces of retroreflecting materials per one m<sup>2</sup>. Category 1 is the lowest category and category 3 presents the highest level of visibility.

	Clothing category 3	Clothing category 2	Clothing category 1
Background material	0.8 m <sup>2</sup>	0.5 m <sup>2</sup>	0.14 m <sup>2</sup>
Retroreflecting material	0.2 m <sup>2</sup>	0.13 m <sup>2</sup>	0.10 m <sup>2</sup>
Material with combined properties	...	...	0.2 m <sup>2</sup>

WELDING CLOTHING

Being category II Personal Protective Equipment, welding clothing has to be certified in EC type test for conformity with Directive 89/686/EEC.

INTENDED USE

Welding protective clothing is required for welding works including welding, surfacing by welding, soldering, bonding, and thermal cutting of metals and thermoplastics. During welding works, welders are at risk of glare, spatter burns, toxic and carcinogenic welding fumes and dust, electromagnetic field, UV and thermal radiation, electrocution, fire, poisoning, and skin, eye, and lung diseases.

MATERIAL REQUIREMENTS

Welding protective clothing is made mainly from flame-retardant cotton fabrics, fire impregnated with high area density, and from natural leather dressed to make it fire retardant.

DESIGN REQUIREMENTS

Welding protective clothing should meet specific design requirements so as to minimize the risk of hot spatter penetrating the clothing:

- Welding clothing should cover the whole body of the wearer during welding: the upper and lower part of the trunk, neck, shoulders, hands, and legs.
- If the clothing consists of a jacket and trousers, the jacket should overlap the waistband at least 20 cm. The minimum overlap should be maintained during all activities and movement when at work.
- Parts of clothing that act as additional protection such as a neck cover, hood, sleeves, apron and gaiters, and gloves should be designed and used to prevent sparks and metal droplets from penetrating the clothing.
- If clothing has pockets, they should be covered with flaps.
- If trousers have pockets, these should be side pockets only that do not protrude from the lateral seam of the trousers more than 10°.
- Trousers should not have cuffs. The clothing should be designed to prevent electricity penetration for example through metal clips.

CLASSES

There are two classes of welding clothing with strictly specified effectiveness requirements:

**Class 1:** - protection against less hazardous welding applications and situations causing moderate exposure to spatter and radiant heat.

**Class 2:** - protection against more hazardous welding applications and situations causing significant exposure to hot factors. The above-mentioned clothing classes were assigned types of welding application and types of process (type of machinery used) as per EN ISO 11611 to help select the right type of welding protective clothing.

Clothing class	Type of welding process	Type of work
Class 1	Manual welding operations during which small amounts of spatter or droplets of molten metal are formed, e.g.: <ul style="list-style-type: none"> <li>• gas welding,</li> <li>• TIG welding,</li> <li>• MIG welding,</li> <li>• microplasma welding,</li> <li>• soldering,</li> <li>• spot welding,</li> <li>• rutile-shielded electrode MMA welding</li> </ul>	Machine operation such as <ul style="list-style-type: none"> <li>• oxygen cutting machines,</li> <li>• plasma cutting machines,</li> <li>• resistance welding machines,</li> <li>• thermal spraying,</li> <li>• welding tables.</li> </ul>
Class 2	Manual welding operations during which large amounts of spatter or droplets of molten metal are formed such as <ul style="list-style-type: none"> <li>• MMA welding (using alkaline or cellulose electrodes),</li> <li>• MAG welding (with CO<sub>2</sub> or mixed gasses),</li> <li>• MIG (high-current) welding,</li> <li>• flux-cored arc welding,</li> <li>• plasma cutting,</li> <li>• gouging,</li> <li>• oxygen cutting,</li> <li>• thermal spraying.</li> </ul>	Machine operation such as <ul style="list-style-type: none"> <li>• in enclosed spaces,</li> <li>• when welding/cutting operations require reaching above head height or take place in similar constrained postures.</li> </ul>

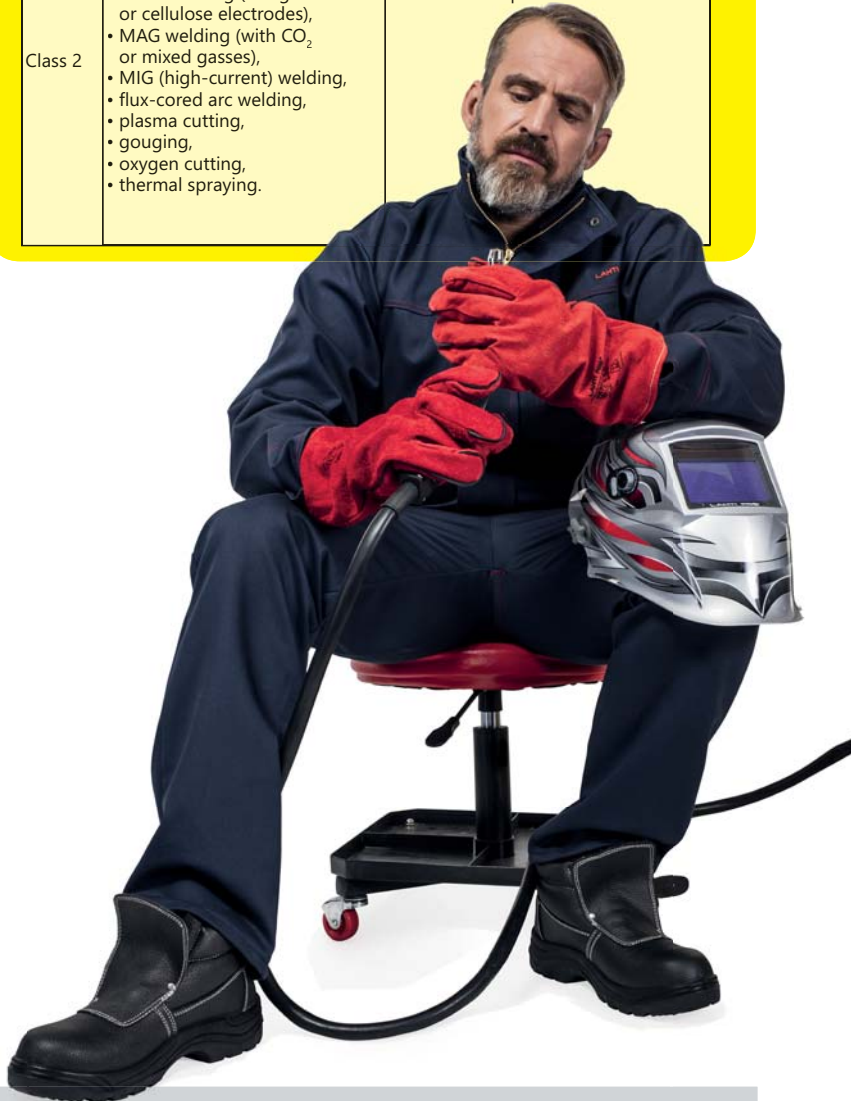

PROLINE  
LAHTI PRO  
MEGA  
JUCO  
OTHER BRANDS  
ERDI  
KLINGSPOR  
EXPRESS  
ACTION CAN  
TRYTON  
VULCAN

**LIST OF STANDARDS**

EN ISO 11611



**EN ISO 11611 Protective clothing for use in welding and allied**

**processes.** This standard species the minimum basic requirements and test methods for protective clothing designed to be worn during welding and allied processes with comparable risks. This type of clothing is intended to protect the wearer against spatter of molten metal, metal grinding sparks, short contact time with flame, and radiant heat from an electric arc. It minimizes the possibility of electrical shock caused by a short-term, accidental contact with live electrical conductors at voltages up to approximately 100 V in normal conditions and during welding.

Procedure A1 – surface ignition test method  
 Procedure A2 – edge ignition test method  
 A1 + A2 conformity – limited flame spread.

EN ISO 11612



**EN ISO 11612 Protective clothing – Clothing to protect against**

**heat and flame – Minimum performance requirements.** The standard specifies requirements for protective clothing designed to protect the wearer's body, except the hands, from heat and flame. The requirements set out in the standard are applicable to a wide variety of protective clothing that should exhibit ignition resistance upon short contact with flame, limit flame spread (A1+A2), and protect from at least one type of heat. Heat protection levels (the higher the number, the better the protection):

- convective heat (B1, B2, B3);
- radiant heat (C1, C2, C3, C4);
- molten aluminum splash (D1, D2, D3);
- molten iron splash (E1, E2, E3);
- contact heat (F1, F2, F3).

**ANTISTATIC CLOTHING**

Being class 2 Personal Protective Equipment, antistatic clothing has to be certified in a EC type test for conformity with Directive 89/686/EEC.

**INTENDED USE**

Antistatic protective clothing is required in hazardous zones (such as in chemical, mining, or oil industry, transport of dangerous substances, gasworks, power plants) and outside hazardous zones (such as the production of electronics to prevent static damage).

**MATERIAL REQUIREMENTS**

Antistatic protective clothing is made of materials that can dissipate and drain off static charge, which prevents incendiary discharges.

**DESIGN REQUIREMENTS**

Antistatic clothing should meet specific design requirements to prevent static discharge:

- Clothing should cover the whole body of the wearer, also in motion and a bent position.
- Clothing should fit well and not restrain movement also when buttoned up during use.
- If clothing is made of a set of materials, the antistatic material should be the outer layer.
- Fasteners made of conductive material such as zip fasteners, buttons, or snap fasteners may be used as long as they are covered with antistatic material.
- In materials that contain parallel or interlaced conductive yarn, the distance between conductive threads running in the same direction should not exceed 10 mm.

**LIST OF STANDARDS**

EN 1149-5



**EN 1149-5 Protective clothing – Electrostatic properties – Part 5: Material and design requirements.** The standard specifies methods for testing electrostatic properties of materials and design requirements for electrostatic dissipative protective clothing used as part of a total earthed system, to avoid incendiary discharges. The requirements may not be sufficient in oxygen-enriched flammable atmospheres. Electrostatic dissipative protective clothing is also known as anti-static clothing.

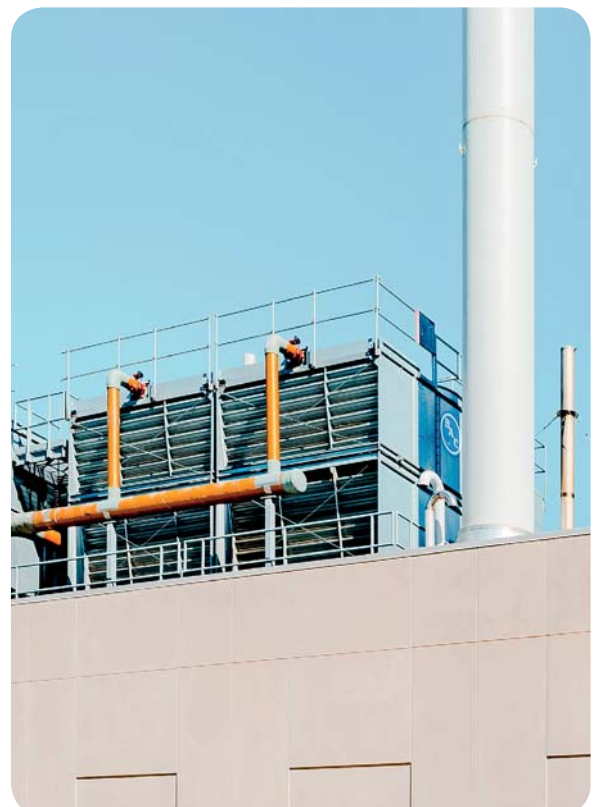

PROLINE

LAHTI PRO

MEGA

JUICO

OTHER BRANDS

ENDI

KLINGSPOR

EXPRESS

ACTION CAN

TRITON

VULCAN

## FALL FROM HEIGHT

Work at heights includes work on scaffoldings, building structures, floor systems, chimneys, ladders, or other elevated locations at the height of at least 1.0 m above the ground or floor level.

Work at height does not include work on a surface that is enclosed at all sides up to at least 1.5 m by solid walls (including with windows) or is equipped with other permanent structures or devices protecting employees from falling, regardless of the height at which the operative stays.

Polish and European regulations related to the occupational safety and health oblige employers of operatives who work at height to ensure appropriate fall protection measures.

Falls from height are a frequent cause of accidents, usually serious or fatal. Work at height is classified as a highly hazardous work, posing a threat to life and health of employees, which is why the personal protective equipment used here is classified as category III. During any work at height, it is necessary to implement special precautionary measures due to the high threat to employees' health and life.

In order to be permitted to work at height, the operative:

- had to be acquainted with the occupational risk related to the work performed;
- have the personal protective equipment necessary to perform such tasks;
- has to have a valid medical certificate for work at height;
- has completed an OSH and job position training acquainting them with the specificity of work at height and hazards present at the workplace.

According to the requirements of the harmonized standard PN-EN 365 Personal protective equipment against falls from a height – General requirements for instructions for use, maintenance, periodic examination, repair, marking and packaging, the periodic inspection of equipment should be carried out every year after it is first used.



To comply with the regulatory requirements, every kit for work at height must include:



**Safety harness (EN 361)** – the primary task of the safety harness is to retain the body during a fall and to ensure safe distribution of dynamic forces that occur during retardation. Only complete safety harnesses with shoulder and thigh straps are devices approved for use as fall protection.



**Anchorage point (EN 362)** – it is the first and key link of the personal fall protection system. Its task is to connect the connecting and shock absorbing component to the load-bearing structure.



**Connecting and shock absorbing component (EN 355)** – it connects the safety harness connecting clamp to the anchor point. If a fall occurs, the connecting and shock absorbing component must stop the fall and minimize the force created during fall retarding. The functions of the connecting and shock absorbing component may be carried out by: energy absorbers with a lanyard, self-locking devices, fall arresters, and other devices.

### LIST OF STANDARDS

#### (EN362)

The standard specifies requirements and examination methods for single and multiple user anchor devices. It further specifies the requirements concerning marking, operating instructions, and installation tips.

#### (EN355)

The standard specifies requirements, examination methods, rules of marking, and information to be provided to the user and a way of energy absorber packing.

#### (EN361)

The standard specifies the requirements, examination methods, rules of marking, information to be provided by the manufacturer, and packaging of the safety harness.

# LEG PROTECTION



Providing adequate protection of legs and feet has a decisive influence mainly on the safety at work, but also the comfort of use. Protective footwear is intended for protection of wearer's feet against injuries that could arise during accidents. Protective footwear may protect the foot against mechanical and chemical agents and harmful effect of the heat, cold, or moisture. Protective footwear most often protects against different types of hazards at the same time. Protection level depends mainly on footwear design, materials used, and equipment such as toe caps, anti-puncture inserts, ankle supports, etc. Footwear with no protective features that is intended for work only because of its hygienic features may not be treated as PPE but as occupational footwear only.

## FOOTWEAR DESIGN



## LIST OF STANDARDS

**EN ISO 20345 – Personal protective equipment – Safety footwear.** This standard specifies basic and additional (optional) requirements for safety footwear used for general purpose. It includes, for example, mechanical risks, slip resistance, thermal risks, ergonomic behavior. Safety footwear (SB, S1 – 4) has protective features together with protection of toes by means of toecaps tested for impact of 200 J.

**EN ISO 20347 – Personal protective equipment – Occupational footwear.** This standard specifies basic and additional requirements for occupational footwear. Special risks are covered by complementary job-related standards (e.g. footwear for firefighters, electrical insulating footwear). Occupational footwear (OB, O1 – 5) - has protective features intended for protection against injuries that may arise during work accident. It is designed for everyday use in places where toe protection by means of toecaps is not required.

## MARKING OF FOOTWEAR

- size
- trademark



- manufacturer's model mark
- serial number
- production date – year and quarter
- standard No.
- CE mark
- safety category and marking with additional symbols depending on additional protective features



FOOTWEAR SAFETY CATEGORIES – BASIC REQUIREMENTS

Safety footwear categories (EN ISO 20345)

Protection category	Toecap protecting toes against 200 J impact	Diesel oil resistance	Energy absorption at heel	Antistatic properties	Heel protection	Puncture resistance to 1100 N	Limited water penetration and absorption	Class
SB								I
S1								I
S2								I
S3								I
S4*								* II (single material footwear)
S5*								* II (single material footwear)

Occupational footwear categories (EN ISO 20347)

Protection category	Toecap protecting toes against 200 J impact	Diesel oil resistance	Energy absorption at heel	Antistatic properties	Heel protection	Puncture resistance to 1100 N	Limited water penetration and absorption	Class
OB	x	x						I
O1	x	x						I
O2	x	x						I
O3	x	x						I
O4*	x	x						* II (single material footwear)
O5*	x	x						* II (single material footwear)

FOOTWEAR SAFETY CATEGORIES – ADDITIONAL REQUIREMENTS

Symbol	Additional requirements
P	Resistance to puncture with a force of up to 1100 N
A	Antistatic properties
C	Current conducting properties
I	Electrical insulating properties
HI	Bottom insulation against heat
CI	Bottom insulation against cold
E	Energy absorption at heel
WR	Limited water penetration and absorption of the whole shoe
WRU	Limited water penetration and absorption of the outside surface of the shoe
HRO	Outsole resistance to high temperature in short contact (up to 300°C ± 5°C / 1 min ± 1 s)
CR	Cut resistance
M	Protection of the ball of the foot
AN	Heel protection
FO	Outsole resistance to diesel oil
SRA	Slip resistance on ceramic surface covered with sodium lauryl sulphate (SLS)
SRB	Slip resistance on steel surface covered with glycerol
SRC	Slip resistance on both surfaces



PROLINE  
LAHTI PRO  
MEGA  
JUCO  
OTHER BRANDS  
ERDI  
KLINGSPOR  
EXPRESS  
ACTION CAN  
TRYTON  
VULCAN





Трудовой кодекс

«Работодатель не может допустить работника к работе без средств индивидуальной защиты, а также рабочей одежды и обуви, предусмотренных для использования на данном рабочем месте»  
(Трудовой кодекс ст. 2379 §1)

„Работодатель обязан доставлять работнику средства индивидуальной защиты, которые отвечают требованиям относительно оценки соответствия, установленные в отдельных правилах»  
(Трудовой кодекс ст. 2376 § 3)

## ПРАВОВОЕ ОСНОВАНИЕ

**Распоряжение Европейского Парламента и Совета (ЕС) 2016/425 от 9 марта 2016 г. По вопросу средств индивидуальной защиты и отмены директивы Совета 89/686/EWG.**

Согласно законодательству Европейского Союза (Директива 89/686/EWG от 21 декабря 1989 г., касающаяся средств индивидуальной защиты, Распоряжение ЕП и Совета ЕС 2016/425 от 9 марта 2016 г. По вопросу средств индивидуальной защиты и отмены директивы Совета (89/686/EWG), а также положениям национального законодательства, касающимся Безопасности и Гигиены Труда и Трудовому кодексу, обязанностью каждого работодателя является снабжение работников средствами индивидуальной защиты, которые будут соответственно приспособлены для защиты от угроз, возникающих на данных рабочих местах.

**„Средство индивидуальной защиты - устройство или оснащение, предусмотренное для ношения или удерживания пользователем с целью обеспечения его защиты от одной или более угроз, которые могут влиять на его безопасность или здоровье“**

### Средство индивидуальной защиты

Средство индивидуальной защиты - достаточно широкое понятие, используется не только для защиты работников на рабочих местах, но и касается также сфер деятельности, не связанных с работой,

таких, например, как спорт или отдых. Примером могут послужить аксессуары, обеспечивающие лучшую видимость работника, и защитная сигнализирующая одежда для непрофессионального применения. Производитель средств индивидуальной защиты перед их введением в продажу должен подтвердить их соответствие с основным требованиям в области безопасности и здравоохранения, указанным в Распоряжении 2016/425. Одним из способов подтверждения соответствия средства индивидуальной защиты основным требованиям является подтверждение того, что данное средство соответствует гармонизированной с указанной директивой норме.

Гармонизированные нормы - это Европейские Нормы, разработанные европейскими нормативными организациями. Они учитывают требования директив и распоряжений ЕС и представляют собой наиболее простой способ подтверждения производителем/импортером изделия предположения о соответствии изделия данной директиве/распоряжению. Подтверждением соответствия средства индивидуальной защиты основным требованиям является маркировка его производителем знаком CE и выдача для него декларации соответствия Распоряжению ЕП и гармонизированным стандартам.



## КАТЕГОРИИ СРЕДСТВ ИНДИВИДУАЛЬНОЙ ЗАЩИТЫ

Распоряжение о средствах индивидуальной защиты разделяет средства индивидуальной защиты на три категории защиты, в зависимости от уровня риска, которому может быть подвергнут работник во время выполнения работы:

Категория защиты	Уровень риска	Описание
I	Низкий	Изделия, входящие в данную категорию, обеспечивают базовый уровень защиты от воздействия внешних факторов низкого риска, последствия которых носят поверхностный характер, защищая, к примеру, от незначительных ушибов, ссадин, загрязнений, действия неагрессивных чистящих средств, атмосферных факторов, не представляющих особой опасности, горячих поверхностей с температурой, не превышающей 50 °С; повреждение зрения в результате воздействия солнечного света (не такого, как при взгляде на солнце); и т.п.
II	Средний	Изделия, принадлежащие к данной категории, используются для защиты в условиях, в которых уровень риска не классифицирован ни как низкий, ни как высокий.
III	Высокий	В категорию III входят исключительно угрозы, которые могут иметь очень серьезные последствия, такие как летальный исход либо не подлежащий восстановлению ущерб здоровью, связанные с опасными для здоровья веществами и смесями, атмосферой с недостаточным содержанием кислорода, вредными биологическими факторами, ионизирующим излучением, средой с высокой температурой, последствия чего сравнимы с воздействием воздуха с температурой, составляющей не ниже 100 °С, средой с низкой температурой, последствия чего сравнимы с воздействием воздуха с температурой, составляющей -50 °С либо ниже, падением с высоты, поражением электрическим током и работами под напряжением, утопанием, порезами переносной цепной пилой, струей под высоким давлением, стреляными либо колотыми ранами, вредным шумом; и т.п.

**Перед выбором соответствующего средства индивидуальной защиты следует:**

- определить уровень риска
- определить тип опасности
- установить класс опасности
- выбрать изделие с определенными параметрами защиты

**Разделение СИЗ на отдельные группы:**

**■ ЗАЩИТА ГОЛОВЫ**

**■ ЗАЩИТА ГЛАЗ И ЛИЦА**

**■ ЗАЩИТА СЛУХА**

**■ ЗАЩИТА ДЫХАТЕЛЬНЫХ ПУТЕЙ**

**■ ЗАЩИТА ТЕЛА**

**■ ЗАЩИТА РУК**

**■ РАБОТА НА ВЫСОТЕ**

**■ ЗАЩИТА НОГ**

## ■ ЗАЩИТА ГЛАЗ И ЛИЦА

Средства защиты глаз и лица предотвращают повреждение глаз и лица, вызванные механическими, химическими, биологическими и термическими факторами, а также вредным излучением.

Средства защиты глаз и лица для профессионального применения должны использоваться везде, где имеют место следующие угрозы:



ушиб  
(например, осколки  
твердых тел)



капли и брызги жидкостей  
(например, брызги,  
возникающие  
во время переливания  
жидких веществ)



оптическое излучение  
(например, излучение,  
возникающее в про-  
цессе сварки, яркий  
солнечный свет, лучи)



расплавленные металлы  
и раскаленные твердые  
тела (например, брызги  
расплавленных металлов,  
образующиеся в ходе  
металлургических  
процессов)



пыль и газы (например,  
угольная пыль или  
аэрозоли вредных  
химических веществ)



электрическая дуга  
(например,  
возникающая во время  
выполнения работ  
под напряжением)

Средства защиты глаз и лица для профессионального применения делятся на три категории:



Очки и гуглы



Средства защиты лица



Сварочные щитки (к данной  
категории относятся щитки, гуглы  
и сварочные капюшоны)



### ПЕРЕЧЕНЬ НОРМ:

**EN 166** - Индивидуальная защита глаз. - Требования. Норма устанавливает функциональные требования для средств защиты глаз различного типа.

**EN 169** - Средства индивидуальной защиты глаз – Сварочные фильтры для смежных технологий - Требования к коэффициенту пропускания излучения и рекомендуемая сфера применения. В норме указаны обозначения фильтров и требования, касающиеся коэффициентов пропускания излучения для фильтров, предназначенных для защиты органов зрения операторов, выполняющих работы, подразумевающие сварку, электромагнитную поверхностную резку и плазменную резку.

**EN 170** - Индивидуальная защита глаз – Фильтры, предохраняющие от ультрафиолетового излучения - Требования относительно коэффициента пропускания излучения и рекомендуемое применение. В норме содержатся правила обозначения, идентификации, подбора и использования фильтров. В норме определены требования к коэффициенту пропускания излучения фильтрами, защищающими от ультрафиолетового излучения.

**EN 172** - Средства индивидуальной защиты глаз – Фильтры, предохраняющие от яркого солнечного света, для промышленного использования. В норме определены критерии подбора и обозначения фильтров, а также коэффициенты пропускания излучения, установлены соответствующие методы испытаний фильтров, предохраняющих от ярких солнечных бликов.

**EN 1731** - Средства индивидуальной защиты глаз – Сетчатая защита глаз и лица. В норме определены используемые материалы, способ проектирования, требования, методы испытаний и обозначение средств индивидуальной защиты глаз и лица из сетчатых материалов, защищающих от механических повреждений.

**EN 175** - Средства индивидуальной защиты – Средства защиты глаз и лица, используемые во время сварки и в смежных процессах. В норме определены требования, касающиеся безопасности и методов испытаний средств индивидуальной защиты, используемых для защиты глаз и лица от вредного оптического излучения и других специфических источников риска или угроз, имеющих место, как правило, во время осуществления сварочных работ, резки или в смежных операциях.

### ОЧКИ И ГУГЛЫ

Маркировка очков и защитных гуглов применяется для их идентификации и правильного подбора для соответствующих видов угроз, имеющих место на данном рабочем месте.

**Стекла** (линзы) и **оправы** (рамки) маркируются отдельно. Если же они представляют собой единое целое, все требуемые символы маркировки должны находиться на оправе (рамке)

### МАРКИРОВКА ОЧКОВ И ГУГЛОВ



**CE 5-3.1 XX 1 FT**

#### МАРКИРОВКА СТЕКОЛ

- знак CE
- тип фильтра (от 2 до 6)
- степень затемнения (от 1,2 до 16)
- идентификационный знак производителя
- оптический класс (от 1 до 3)
- символ механической прочности („S“, „F“, „B“, „A“)
- символ дополнительных защитных свойств („K“, „N“, „R“, „T“)

#### МАРКИРОВКА ОПРАВ



**CE**

- знак CE
- идентификационный знак производителя
- номер стандарта
- символ механической прочности („S“, „F“, „B“, „A“)

### КЛАССЫ СРЕДСТВ ЗАЩИТЫ ЛИЦА И ГЛАЗ – МЕХАНИЧЕСКИЕ ТРАВМЫ

ПАРАМЕТР	ОЧКИ	ГУГЛЫ	СРЕДСТВА ЗАЩИТЫ ЛИЦА
Повышенная стойкость к ударам (5,1м/с) – обозн. S	+	+	+
Стойкость к ударам низкой энергии (45 м/с) – обозн. F	+	+	+
Стойкость к ударам средней энергии (120 м/с) – обозн. B	-	+	+
Стойкость к ударам высокой энергии (190 м/с) – обозн. A	-	-	+

#### Тип фильтра Защита от излучения:

<b>2</b>	фильтр, защищающий от ультрафиолетового излучения (UV)
<b>2С или 3</b>	фильтр, защищающий от ультрафиолетового излучения (UV), хорошее различение цветов
<b>4</b>	фильтр, защищающий от инфракрасного излучения (IR)
<b>5</b>	антибликовый фильтр (солнцезащитный) без требований, касающихся инфракрасного излучения
<b>6</b>	антибликовый фильтр (солнцезащитный) с требованиями, касающимися инфракрасного излучения

#### Степень затемнения Коэффициент механической стойкости:

1.2	100 - 74.4 %
1.4	74.4 - 58.1%
1.7	58.1 - 43.2%
2.0	43.2 - 29.1%
2.0	43.2 - 29.1%
2.5	29.1 - 17.8%
3.1	17.8 - 8.0%
4.1	8.0 - 3.0%
...	
16	0.000061 - 0.000023%

#### Оптический класс:

- 1 для постоянного использования
- 2 для периодического использования
- 3 для кратковременного использования

#### Символы механической стойкости:

- S** повышенная энергия удара - устойчивость к удару стальным шариком с номинальным диаметром 22 мм, массой 43 г со скоростью 5,1 м/с
- F** низкая энергия удара - устойчивость к удару стальным шариком с номинальным диаметром 6 мм, массой 0,86 г со скоростью 45 м/с
- B** средняя энергия удара - устойчивость к удару стальным шариком с номинальным диаметром 6 мм, массой 0,86 г со скоростью 120 м/с
- A** высокая энергия удара - устойчивость к удару стальным шариком с номинальным диаметром 6 мм, массой 0,86 г со скоростью 190 м/с (применяется для изготовления защитных элементов для лица).

#### Символы сфер применения (применяемые в случае защитных гуглов)

- 3 защита от жидкостей (в виде капель либо брызг)
- 4 защита от крупных частиц пыли (крупнее 5 мкм)
- 5 защита от газов и мелких частиц пыли (пар, туман, дым и пыль с размером частиц менее 5 мкм)
- 8 защита от дуги, образующейся во время короткого замыкания
- 9 защита от расплавленного металла и попадания горячих твердых частиц

#### Символы дополнительных защитных свойств:

- K** стойкость к поверхностным повреждениям мелкими частицами пыли
- N** стойкость к помутнению (запотеванию)
- R** увеличенный коэффициент отражения света
- T** защита от мелких частиц в условиях экстремальных температур. Гарантированная стойкость между -5°C - 55°C

## СРЕДСТВА ЗАЩИТЫ ЛИЦА

Эти средства защищают все лицо, а большая защищающая площадь минимизирует вероятность проникновения внутрь опасных брызг жидкости. Средства защиты лица можно использовать вместе с очками (защитными либо корректирующими), гуглами и некоторым оснащением, служащим для защиты дыхательной системы

Маски надеваются непосредственно на голову пользователя или устанавливаются на защитную каску. Стекла масок данного типа изготовлены, как правило, из поликарбоната, окрашенного в массу, или поликарбоната с нанесенными покрытиями, отражающими тепловое излучение, используются при особо интенсивном тепловом излучении.

### МАРКИРОВКА СРЕДСТВ ЗАЩИТЫ ЛИЦА



- знак, идентифицирующий производителя, обозначение модели
- номер нормы
- оптический класс
- механическая стойкость
- защита от частиц, имеющих большую скорость
- защита от брызг жидкостей
- знак CE

## СВАРОЧНЫЕ МАСКИ

Сварочные шлемы и сварочные щитки используются при сварке электрической дугой или электрической поверхностной резке, кислородной резке или плазменной резке. Сварочные шлемы могут быть оснащены одинарным сварочным фильтром или двумя сварочными фильтрами, один из которых является только обзорным фильтром, а второй - основным затемненным фильтром, используемым для контроля процесса сварки.

Также используются сварочные шлемы, оснащенные автоматическими сварочными фильтрами. Данные фильтры автоматически затемняют поле обзора в момент, например, необходимости наблюдения за электрической дугой или струей плазмы, а после затухания дуги (со скоростью остывания шва) самостоятельно просветляются. Кроме этого

шлемы могут быть оснащены вентиляционной системой, подающей воздух из пространства за головой сварщика, что существенно ограничивает количество вдыхаемых сварочных дымов (пыли и газов), образующихся во время сварки, или же оснащены держателями, позволяющими установить фильтрационное оборудование с принудительным потоком воздуха.

Сварочный щиток предназначен для защиты глаз, всего лица и шеи сварщика. Основным ограничением использования сварочного щитка является необходимость удерживания его в руках во время сварки, что существенно уменьшает свободу движений работника, к примеру, делая невозможным удержание свариваемого предмета.

### МАРКИРОВКА СРЕДСТВ ЗАЩИТЫ ЛИЦА СВАРЩИКА



- знак, идентифицирующий производителя, обозначение модели
- номер нормы
- знак CE

### Подбор сварочного фильтра в соответствии с EN169/EN175

ПРОЦЕСС	CURRENT [A]																											
	1.5	6	10	15	30	40	60	70	100	125	150	175	200	225	250	300	350	400	450	500	600							
Покрытые электроды	8				9				10				11				12				13				14			
MAG	8				9				10				11				12				13				14			
Сварка TIG	8				9				10				11				12				13				14			
MIG-сварка тяжелых металлов	8				9				10				11				12				13				14			
MIG-сварка легких сплавов	8				9				10				11				12				13				14			
Электровоздушное долбление	10				11				12				13				14				15							
PAC	10				11				12				13				14				15							
PAW	4	5	6	7	8	9	10	11	12	13	14	15	16	17	18	19	20	21	22	23	24	25						

- **MIG** - сварка плавким электродом в атмосфере инертного газа
- **MAG** - сварка плавким электродом в среде химически активного газа
- **TIG** - сварка вольфрамовым электродом в среде инертного газа
- **Электровоздушное долбление** - с использованием угольного электрода и струи сжатого воздуха, используемого для выдувания расплавленного металла
- **PAC** - резка плазменной струей
- **PAW** - сварка дугой микроплазмы

# ■ ЗАЩИТА ГОЛОВЫ

## МАРКИРОВКА КАСОК

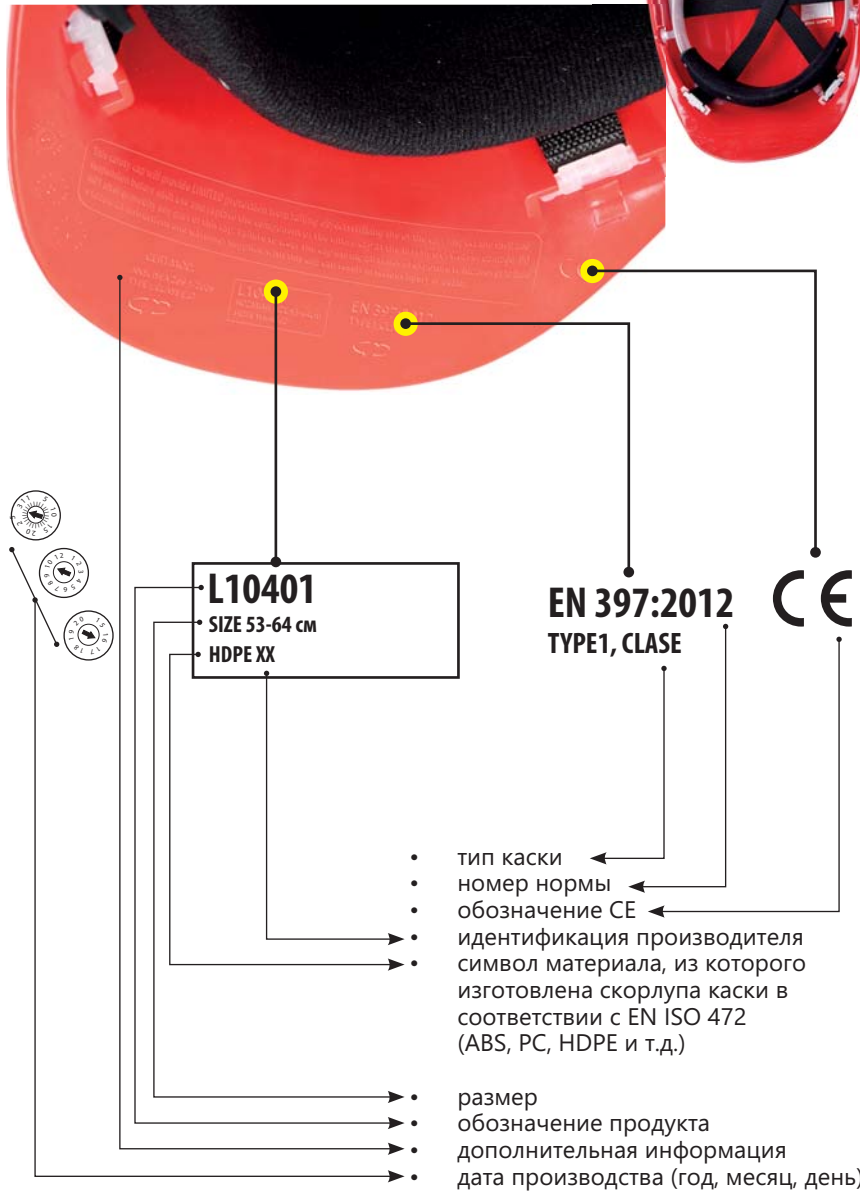

### ПЕРЕЧЕНЬ НОРМ

**EN 397** - Промышленные защитные каски. Норма устанавливает конструкционные требования и защитные параметры, методы испытаний и требования, касающиеся маркировки защитных касок для промышленного применения. Установлены обязательные и дополнительные требования, касающиеся защитных свойств.

#### Обязательные требования

- **амортизационная способность** (Энергия удара, передаваемая на макет головы, не должна превышать 5 кН во время падения бойка массой 5 кг с высоты 1 м)
- **пробивная прочность** (Пробойник массой 3 кг, падая с высоты 1 м, не должен деформировать каску до той степени, при которой он бы прикоснулся к макету головы)
- **Стойкость к воздействию пламени** (Пламя горелки под углом 45 градусов к вертикали должно находиться на расстоянии 50 - 100 мм и соприкасаться с верхом скорлупы в течение 10 с. Скорлупа каски не должна гореть и распространять пламя в течение более 5 с после удаления пламени)

#### Дополнительные требования:

- способность к амортизации при очень низких температурах -20°C или -30°C
- способность к амортизации при очень высоких температурах + 150°C
- электроизоляционная способность - 440 В переменного тока
- боковые деформации - **LD**
- брызги расплавленного металла - **MM**

### Срок годности касок

Дата изготовления каски оттиснена на внутренней стороне скорлупы (чаще всего сверху). Она закодирована в виде трех дисков. Наконечник стрелки внутри каждого диска указывает год, месяц и дату изготовления, соответственно. Полный объем защитных свойств каска сохраняет в течение 2-х лет с даты начала его использования, однако не дольше, чем 3 года от даты изготовления.

# ■ ЗАЩИТА СЛУХА

### ПЕРЕЧЕНЬ НОРМ

**EN352-1** - Средства защиты органов слуха - Общие требования - Часть 1: Противошумные наушники. В стандарте указаны требования, касающиеся конструкции, проектирования, работы, маркировки и информации для пользователя противошумных наушников.

**EN352-2** - Средства защиты органов слуха - Общие требования - Часть 2: Противошумные вкладыши. В норме указаны требования, касающиеся конструкции, проектирования, работы, маркировки и информации для пользователя противошумных вкладышей.

**EN352-3** - Средства защиты органов слуха - Общие требования - Часть 3: Противошумные наушники, крепящиеся на промышленной защитной каске. В норме указаны требования, касающиеся конструкции, проектирования, работы, маркировки и информации для пользователя противошумных наушников, предназначенных для крепления к промышленным каскам.

### Основные параметры нормы EN352

- **возможность регулировки** - оценивается возможность подгонки наушников к головам разных размеров
- **сила нажима дужки** - максимальная сила нажима дужки составляет 14 Н
- **сила нажима шумопоглощающей чаши** - максимальная сила нажима звукоподавляющих подушек составляет 4500 Па
- **стойкость к повреждениям** - изделие падает с высоты 1,5 метра на стальную пластину
- **воспламеняемость** - стержнем, разогретым до 650°C ± 20°C прикасаются к поверхности изделия, воздействуя на нее 5 секунд; поверхность не должна загореться или тлеть после удаления стержня.

## ТРЕБОВАНИЯ ДИРЕКТИВЫ 2003/10/ЕС

Минимальные требования к защите работников от угроз, связанных с воздействием шума

Подверженность воздействию шума в течение 8 часов на уровне $\geq 85$ дБ	Подверженность воздействию шума в течение 8 часов на уровне $\geq 80$ дБ	Подверженность воздействию шума в течение 8 часов на уровне $> 70$ дБ и $\geq 80$ дБ
Средства защиты органов слуха обязательна	Средства защиты органов слуха в распоряжении работника	Средства защиты органов слуха рекомендуются

Средства защиты органов слуха являются самым простым и быстрым способом защиты органов слуха от последствий воздействия шума.

### Средства защиты органов слуха делятся на:



Противошумные наушники.

Беруши (противошумные вкладыши)

### ПРОТИВОШУМНЫЕ НАУШНИКИ

Шумоподавляющие наушники состоят из двух поглощающих шум чаш, которые охватывают мочки ушей и прилегают к голове мягкими уплотнительными подушками, наполненными обычно пенкой из искусственного материала либо жидкостью. Шумоподавляющие чаши обычно заполнены звукопоглощающим материалом. Противошумные наушники могут быть независимыми или крепится к защитным каскам.

### БЕРУШИ

Беруши (противошумные вкладыши) - это средства защиты органов слуха, которые вставляются в наружный слуховой проход. Они предназначены для плотного закрытия слухового прохода. беруши для ушей делятся на затычки одноразового и многоразового пользования. Они могут иметь форму, приданную производителем (например, силиконовые), или формироваться пользователем (например, пенные). Также существуют беруши в версии с дужкой, которая выполняет функцию прижимной пружины и предназначена для их удержания внутри или у входа в слуховой проход. Дужку можно носить на верхней части головы, под подбородком или сзади головы. Размер вкладок должен быть тщательно подобран для каждого пользователя индивидуально, поскольку неправильно подобранные вкладыши могут вызывать чувство дискомфорта или раздражения слухового прохода.



### МАРКИРОВКА БЕРУШЕЙ

Учитывая специфику изделия, маркировка берушей должна размещаться на упаковке или дозаторе.

- руководство к надеванию и пользованию
- размер
- номер нормы
- знак CE

### МАРКИРОВКА НАУШНИКОВ

- знак, идентифицирующий производителя
- знак CE
- номер нормы
- маркировка передняя/задняя часть, верх/низ, если расположение чаш имеет значение

## ВЕЛИЧИНА ПОДАВЛЕНИЯ ШУМА

**SNR**

(Simplified Noise Reduction)  
Единичная, средняя величина подавления.

**HML**

Величина глушения выражается в зависимости от среднего уровня частоты

**H:** Подавление высоких частот (высокие тона)

**M:** Подавление средних частот

**L:** Подавление низких частот (низкие тона)

# СРЕДСТВА ЗАЩИТЫ ОРГАНОВ ДЫХАНИЯ

## МАРКИРОВКА РЕСПИРАТОРОВ



### ПЕРЕЧЕНЬ НОРМ

**EN149:2001** Оснащение защиты органов дыхательной системы - Фильтрующие полумаски для защиты от частиц - Требования, испытание, маркировка. Применены к фильтрующим полумаскам, относящимся к III категории защиты. Определяют минимальные требования, касающиеся испытаний, а также маркировки фильтрующих полумасок, используемых как оснащение, защищающее от частиц, за исключением респираторов, которые используются в случае утечки.

**MAC** – предельно допустимые концентрации токсичного химического соединения или концентрация иного вредного фактора, воздействие которого на работника при 8-часовом суточном и среднем недельном режиме работы, установленном в Трудовом кодексе, на протяжении периода его профессиональной активности не должно вызывать отрицательных изменений в его состоянии здоровья.

### ИСПОЛЬЗОВАНИЕ СРЕДСТВ ЗАЩИТЫ ДЫХАТЕЛЬНЫХ ПУТЕЙ ВО ВРЕМЯ РАБОТЫ ТРЕБУЕТСЯ, ЕСЛИ:

- концентрация опасных веществ в воздухе превышает Предельно Допустимую Концентрацию (**NDS**) для этих веществ
- содержание кислорода во вдыхаемом воздухе ниже 17% его общего состава
- температура вдыхаемого воздуха превышает допустимые нормы, при которых человек может работать

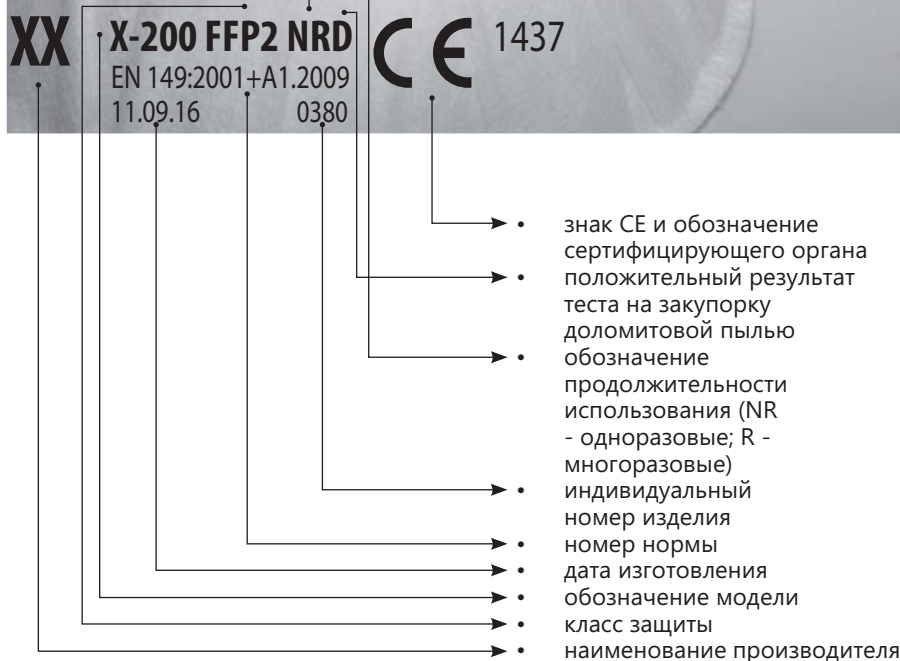

Фильтрующие полумаски делятся в зависимости от эффективности фильтрования на три класса: **FFP1, FFP2, FFP3**.

Таблица эффективности фильтрации для каждого отдельного класса

	FFP1	FFP2	FFP3
Концентрация вредных веществ	до 4хMAC	до 10хMAC	до 30хMAC
Эффективность фильтрации	80%	94%	99%
Прохождение	20%	6%	1%
Изначальное сопротивление выдыханию при течении 95 л/мин.	<210 Па	<240 Па	<300 Па

# СРЕДСТВА ЗАЩИТЫ РУК

Необычайно важным элементом средств индивидуальной защиты являются защитные перчатки, служащие для защиты кистей от нежелательных либо/и вредных для здоровья и опасных для жизни факторов. Правильно подобранные защитные перчатки не только обеспечивают соответствующую защиту кисти, но также гарантируют максимальное удобство пользования, позитивно влияя на безопасность и качество выполняемой работы.







## КРИТЕРИИ ПРАВИЛЬНОГО ВЫБОРА ЗАЩИТНЫХ ПЕРЧАТОК

### Размер

В таблице ниже представлены требования нормы **EN 420** в области размеров перчаток, соотносимых с соответствующими размерами ладони. Защитные перчатки марки Lahti Pro обеспечивают пользователю оптимальную подгонку к ладони, гарантируя как безопасность, так и высокий комфорт пользования.

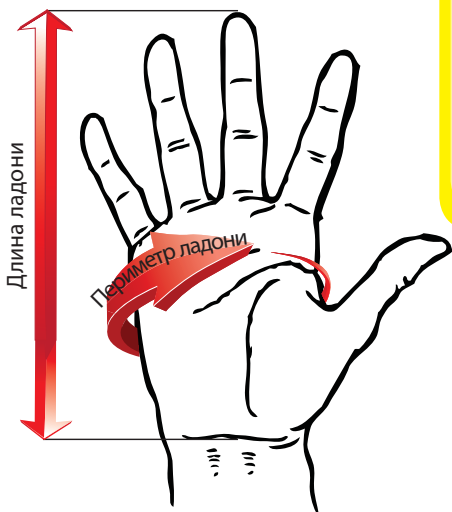

## ПЕРЕЧЕНЬ НОРМ

### EN 420

- **Защитные перчатки** - Общие требования и методы испытаний. Применимы ко всем защитным перчаткам, независимо от категории защиты, к которой перчатки отнесены (таким образом, касается категории защиты I, II, а также III). Установленные в нем общие требования и соответствующие испытательные процедуры, касающиеся проектирования и конструкции перчаток, стойкости материалов перчаток к проникновению воды, безопасности, удобства пользования и эффективности, маркировки и информации, предоставляемой производителем, которые применимы ко всем защитным перчаткам.

### EN 388 - Перчатки, защищающие от механических повреждений рук.

Норма применима к защитным перчаткам, отнесенным ко II категории защиты. В ней содержатся требования, методы испытаний, маркировка и информация, доставляемая пользователю. Испытания перчаток включают в себя проверку: стойкости к таким механическим повреждениям, как истирание, порез ножом, разрыв и пробивание. Параметры механической стойкости перчаток описаны с помощью четырех цифр, находящихся внизу пиктограммы.

### EN 407 - Перчатки, защищающие от теплового воздействия (высокая температура и/или огонь).

Норма применима к защитным перчаткам, отнесенным ко II категории защиты. В ней содержатся общие требования, методы испытания, уровни эффективности в области термостойкости, маркировка, информация, доставляемая пользователю. Перчатки проходят испытания на стойкость к воздействию огня, высокой температуры и т.п., параметры термостойкости перчаток описываются с помощью шести цифр, указанных внизу пиктограммы.

**EN 511 - Перчатки, защищающие от холода.** Норма применима к защитным перчаткам, отнесенным ко II категории защиты. В ней содержатся требования, касающиеся маркировки, информации, предоставляемой пользователю, а также испытания перчаток, защищающих от конвекции и пропускания холода до  $-50^{\circ}\text{C}$ . Параметры термической стойкости перчаток определены с помощью трех цифр, указанных внизу пиктограммы.

Размер перчатки	Длина кисти руки	Контур кисти
6 [XS]	16.0 см	это 15.2 см
7 [S]	17.1 см	это 17.8 см
8 [M]	18.2 см	это 20.3 см
9 [L]	19.2 см	это 22.9 см
10 [XL]	20.4 см	это 25.4 см
11 [2XL]	21.5 см	это 27.9 см

**EN ISO 10819 - Вибрация и механические удары.** Вибрация, воздействующая на организм человека через верхние конечности - Измерение и оценка коэффициента передачи вибрации через перчатки на руки оператора. Норма применима к защитным перчаткам, отнесенным ко II категории защиты. В ней содержатся требования, касающиеся маркировки, информации, предоставляемой пользователю, а также определен метод лабораторного измерения, способ анализа данных и составления протокола определения коэффициента передачи вибрации через перчатки, изготовленные из материалов, уменьшающих вибрацию, покрывающие кисть и пальцы руки вместе с большим пальцем. В соответствии с установленной процедурой испытаний для перчаток, предлагаемых для защиты от вибраций, определены два характеризующие перчатки числовых коэффициента:

- скорректированный коэффициент передачи вибрации TRM (в диапазоне средних частот) для тестового сигнала M (диапазон частоты 32-200 Гц).
- скорректированный коэффициент передачи вибрации TRH (в диапазоне высоких частот) для тестового сигнала M (диапазон частоты 200-250 Гц).

### EN 12477 - Защитные перчатки для сварщиков.

Норма применима к защитным перчаткам, отнесенным ко II категории защиты. В ней содержатся требования, касающиеся маркировки, информации, предоставляемой производителем, испытания сварочных перчаток, используемых при ручной сварке металла, резке и в смежных процессах. В соответствии с вышеуказанной нормой сварочные защитные перчатки делятся на следующие группы:

- тип A (обеспечивают соответствие требованиям в области защитных свойств на высшем уровне)
- тип B (используемые для работ, требующих хорошей цепкости и чувствительности пальцев, например, при сварке методом TIG).

### EN381-7 - Требования к перчаткам, защищающим от порезов цепной пилой.

Установлены требования, касающиеся перчаток, применяемых в качестве защиты во время пользования переносной цепной бензопилой. Определены два вида перчаток, предохраняющих от пореза цепной пилой - образец А и образец Б. Установлены требования, касающиеся стойкости к разрезанию цепной пилой, стойкости к воздействию механических факторов, эргономики и маркировки, информации производителя, инструкции по эксплуатации. Размещены также указания, касающиеся выбора соответствующего образца защитных перчаток. С точки зрения защиты от порезов цепной пилой, перчатки подразделяются на четыре класса в зависимости от скорости движения цепи пилы: Класс 0 - 16 м/с, Класс 1 - 20 м/с, Класс 2 - 24 м/с, Класс 3 - 28 м/с.

EN388



абвгде

Параметр	Уровень 1	Степень 2	Степень 3	Степень 4	Степень 5	
(а) Стойкость к истиранию (количество циклов)	100	500	2000	8000	-	
<b>(б) Стойкость к разрезу (индекс)</b>	<b>1.2</b>	<b>2.5</b>	<b>5.0</b>	<b>10.0</b>	<b>20.0</b>	
(в) Прочность на разрыв [N]	10	25	50	75	-	
<b>(г) Стойкость к проколу [N]</b>	<b>20</b>	<b>60</b>	<b>100</b>	<b>150</b>	<b>-</b>	
Параметр	Уровень А	Уровень Б	Уровень В	Уровень Г	Уровень Д	Уровень Е
(д) Стойкость к порезам согл. ISO 13977 [N]	2	5	10	15	22	30
Параметр	Уровень Р					
(е) Стойкость к истиранию согл. EN 13594:2015	ДА					

Параметры а-г согласно EN 388:2002; параметры в-е согласно EN 388:2016

EN407



абвгде

Характеристика	Уровень 1	Степень 2	Степень 3	Степень 4
(а) Сохранность во время горения				
<b>Время дальнейшего горения, [с]</b>	<b>≤ 20</b>	<b>≤ 10</b>	<b>≤ 3</b>	<b>≤ 2</b>
Время дальнейшего тления, [с]	Отсутствие требований	≤ 120	≤ 25	≤ 5
<b>(б) Стойкость к контактному теплу</b>				
Температура контакта Tc [°C]	100	250	350	500
<b>Граничное время tt [с]</b>	<b>≥ 15</b>	<b>≥ 15</b>	<b>≥ 15</b>	<b>≥ 15</b>
(в) Стойкость к конвекционному теплу				
<b>Показатель передачи тепла НТИ [с]</b>	<b>≥ 4</b>	<b>≥ 7</b>	<b>≥ 10</b>	<b>≥ 18</b>
(г) Стойкость к тепловому излучению	20	60	100	150
<b>Теплопередача t24 [с]</b>	<b>≥ 7</b>	<b>≥ 20</b>	<b>≥ 50</b>	<b>≥ 95</b>
(д) Стойкость к воздействию мелких брызг расплавленного металла				
<b>Количество капель</b>	<b>≥ 10</b>	<b>≥ 15</b>	<b>≥ 25</b>	<b>≥ 35</b>
(е) Стойкость к воздействию большого количества расплавленного металла				

EN12477

Свойства	Требования	
	Тип А	Тип В
Стойкость к истиранию - уровень эффективности (в количестве циклов)	2 (500)	1 (100)
<b>Стойкость к порезам - уровень эффективности (показатель I)</b>	<b>1 (1.2)</b>	<b>1 (1.2)</b>
Прочность на разрыв - уровень эффективности (величина в N)	2 (25)	1 (10)
<b>Устойчивость к проколу - уровень эффективности (величина в N)</b>	<b>2 (60)</b>	<b>1 (20)</b>
Сохранность во время горения - уровень эффективности	3 (время дальнейшего горения ≤ 3 с, время дальнейшего тления ≤ 25 с)	2 (время дальнейшего горения ≤ 3 с, время дальнейшего тления ≤ 25 с)
<b>Стойкость к контактному теплу - уровень эффективности (темп. контакта при °C)</b>	<b>1 (100)</b>	<b>1 (100)</b>
Стойкость перед мелкими брызгами расплавленного металла - уровень эффективности (количество капель)	2 (≥7)	отсутствие требований
<b>Удобство - уровень эффективности (диаметр прута в мм)</b>	<b>1 (11)</b>	<b>4 (6.5)</b>

EN511



абв

Параметр	Уровень 1	Степень 2	Степень 3	Степень 4
(а) теплоизоляционная способность				
<b>Теплоизоляционная способность ITR [м2К/Вт]</b>	<b>0.10 ≤ ITR &lt; 0.15</b>	<b>0.15 ≤ ITR &lt; 0.22</b>	<b>0.22 ≤ ITR &lt; 0.30</b>	<b>0.30 ≤ ITR</b>
(б) Термическое сопротивление				
<b>Тепловое сопротивление R [м2К/Вт]</b>	<b>0.025 ≤ R &lt; 0.050</b>	<b>0.050 ≤ R &lt; 0.100</b>	<b>0.100 ≤ R &lt; 0.150</b>	<b>0.150 ≤ R</b>

В - Параметр – стойкость к промоканию – 0 или 1

**Материал, из которого изготовлено покрытие / ладонная часть перчатки**

**ПЕРЧАТКИ „ДЛЯ АВТОМАСТЕРСКИХ“ ИЗ ИСКУССТВЕННОЙ КОЖИ**

Искусственная кожа - материал, отличающийся прочностью и стойкостью к износу. Перчатки, изготовленные из искусственной кожи, отличаются многочисленными усилениями или/и подушками, защищающими от мозолей и вибрации, также имеют регулировочную застежку-липучку.

Благодаря длительному сроку службы, удобству использования и превосходному осязанию удерживаемого в руках предмета, данные перчатки очень часто используются в автомастерских, в связи с чем широко известны как рабочие перчатки для СТО. Кроме этого они пользуются большой популярностью в транспортной промышленности, при выполнении складских работ, а также во всякого рода занятиях во время досуга.

**ПЕРЧАТКИ ИЗ НАТУРАЛЬНОЙ КОЖИ**

Перчатки, изготовленные из натуральной кожи, характеризуются высокой стойкостью к износу и разрывам. Отличаются также хорошей воздухопроницаемостью. Обеспечивают максимальный комфорт пользования и хороший захват удерживаемого предмета, удовлетворяя требования даже наиболее взыскательного пользователя. Учитывая их богатые практические свойства, кожаные перчатки применяются в многочисленных отраслях, таких как, например, строительство, перевозки, автомобильная промышленность, сельское хозяйство.

**ПЕРЧАТКИ, ПОКРЫТЫЕ ЛАТЕКСОМ**

Латекс - материал, наиболее часто используемый для изготовления покрытия защитных перчаток. Перчатки, покрытые латексом либо изготовленные из него, отличаются высокой эластичностью, также при низких температурах, высокой стойкостью к разрыву и превосходно проявляют себя даже в самых сложных атмосферных условиях. Универсальность латекса, как и относительно невысокая стоимость его изготовления, означают, что латексные перчатки также могут использоваться на стройке, складе, в транспортной промышленности, сельском хозяйстве, домашнем хозяйстве, в огороде и саду.

**УТЕПЛЕННЫЕ ПЕРЧАТКИ**

Утепленные перчатки предназначены для работ в сложных атмосферных условиях, также при низких температурах. Их покрытие обеспечивает их универсальность, а смесь синтетических волокон, не впитывающих воду и удерживающих тепло, защищают пользователя от холода, дождя, снега и ветра. Утепленные перчатки применяются, в частности, на стройке, в транспортной промышленности, в холодильных камерах.



**ПЕРЧАТКИ, ПОКРЫТЫЕ НИТРИЛОМ**

Нитрил, из которого изготовлены перчатки марки Lahti Pro - синтетическая смесь резины, состоящая из акрилонитрила и бутадиена, которая не содержит белков латекса. Комбинация этих двух компонентов создает эластичный и высокостойкий к истиранию материал, обеспечивающий одновременно превосходную устойчивость к не содержащему свинец бензину, дизельному топливу, гексану, парафину. Превосходно защищают также от масел и смазочных материалов. Перчатки, покрытые нитрилом, часто используются в транспортной и автомобильной промышленности, а также в сельском хозяйстве и садоводстве. Также они являются идеальной альтернативой для людей, имеющих аллергию на латекс.

**ПЕРЧАТКИ С ПОКРЫТИЕМ ИЗ ПОЛИУРЕТАНА (ПУ)**

Полиуретан - материал, отличающийся очень высокой эластичностью и высокой стойкостью к истиранию и разрыву. Благодаря этим свойствам он идеально подходит для производства перчаток с тонким и одновременно очень прочным покрытием. Полиуретановые перчатки обеспечивают своему пользователю высокую цепкость и превосходное осязание удерживаемого предмета, идеально проявляя себя, в частности, в работах, требующих высокой точности. Данные перчатки часто используются механиками, работниками складов, а также владельцами частных домов и др.

**ПЕРЧАТКИ, ПОКРЫТЫЕ ПВХ**

Перчатки, покрытые ПВХ, отличаются превосходной стойкостью, в частности, к воздействию смазочных материалов, масел, жиров, неагрессивных чистящих средств, а также воде, относительно хорошо проявляют себя при низких температурах. Они применяются в различных отраслях, в т.ч., например, в автомобильной промышленности, сельском хозяйстве, транспортной промышленности.



**Свойства материалов, из которых изготовлены покрытия/ладонная часть перчатки**

Свойства покрытия	Тип покрытия/ладонной части перчатки					
	Искусственная кожа*	Натуральная кожа	Латекс	Нитрил	Полиуретан (ПУ)	ПВХ
Растяжимость	1	1	5	4	5	3
Противоскользящие свойства	1	2	4	5	3	5
Цепкость (ощущение удерживаемого предмета)	5	4	3	4	5	3
Стойкость к истиранию	5	5	2	5	5	4
Прочность на разрыв	5	5	5	1	5	1
Стойкость к проколу	5	5	2	5	2	3
Стойкость к воздействию воды и водных растворов	1	2	5	3	3	5
Устойчивость к смазочным материалам и маслам	2	3	2	5	4	5
Стойкость к углеводородам	1	1	1	4	1	2
Устойчивость к стиральным средствам и моющим средствам	1	1	5	4	4	5
Стойкость к воздействию кетоновых растворителей	1	1	4	1	2	1

1   
 2   
 3   
 4   
 5  
 Очень низкая    Низкая    Средняя    Высокая    Очень высокая

\*Ладонная часть многих моделей перчаток марки Lahti Pro, изготовленных из синтетической кожи, снабжена множеством усиливающих вставок из ПВХ, не скользящей силиконовой сеткой и т.д., значительно улучшая свойства перчатки. Информация, приведенная в выше представленной таблице, касается только и исключительно искусственной кожи, не учитывает, соответственно, свойств дополнительных материалов.

**Примечание:** Вышеуказанная таблица имеет ознакомительный характер и представляет перечень свойств, характерных для отдельных типов покрытия/ладонной части перчаток. Свойства покрытия/ладонной части могут отличаться в зависимости от модели перчатки.



**Тип трикотажа, из которого должны быть изготовлены перчатки**

В следующей таблице приведены основные преимущества отдельных трикотажных тканей, используемых для изготовления защитных перчаток:

Тип трикотажа	Преимущества	
Полиэстер	<ul style="list-style-type: none"> <li>➢ Возможность сочетания с хлопком для повышения комфорта пользования</li> <li>➢ Крепкий и прочный</li> <li>➢ Стойкий к истиранию и растяжению</li> </ul>	<ul style="list-style-type: none"> <li>➢ Стойкий к намоканию</li> <li>➢ Быстро высыхающий</li> <li>➢ Эластичный</li> </ul>
Хлопок	<ul style="list-style-type: none"> <li>➢ Хорошо дышащий, проветриваемый, не задерживает тепла</li> <li>➢ Мягкий на ощупь (высокий комфорт пользования)</li> <li>➢ Стойкий к истиранию</li> </ul>	<ul style="list-style-type: none"> <li>➢ Впитывает пот</li> <li>➢ Не электризуется</li> </ul>
Нейлон	<ul style="list-style-type: none"> <li>➢ Крепкий и прочный</li> <li>➢ Высокая стойкость к истиранию и растяжению</li> <li>➢ Стойкий к воздействию масел, жиров и бензина</li> </ul>	<ul style="list-style-type: none"> <li>➢ Устойчивость к намоканию</li> <li>➢ Эластичный</li> </ul>
Акрил	<ul style="list-style-type: none"> <li>➢ Досконально защищает от холода</li> <li>➢ Мягкий на ощупь (высокий комфорт пользования)</li> <li>➢ Водостойкость</li> </ul>	<ul style="list-style-type: none"> <li>➢ Стойкий к истиранию и растяжению</li> <li>➢ Стойкость к воздействию масла</li> </ul>
Модифицированное синтетическое волокно	<ul style="list-style-type: none"> <li>➢ Высокая стойкость к прорезам</li> <li>➢ Необычайно высокая стойкость к истиранию и растяжению</li> </ul>	<ul style="list-style-type: none"> <li>➢ Устойчивость к промоканию</li> <li>➢ Эластичное</li> </ul>

PROLINE  
 LAHTI PRO  
 MEGA  
 JUCO  
 OTHER BRANDS  
 ENPI  
 KLINGSPOR  
 EXPRESS  
 ACTION CAR  
 TRYTON  
 VULCAN

# ЗАЩИТА ТЕЛА

## МАРКИРОВКА ЗАЩИТНОЙ ОДЕЖДЫ

- знак CE
- категория защиты
- способ ухода
- дата изготовления – месяц и год, серийный номер
- товарный знак
- диапазон размеров



- маркировка производителя
- размер
- тип изделия
- номер нормы

## РАЗМЕР

C - ширина грудной клетки  
W - ширина в поясе  
H - высота

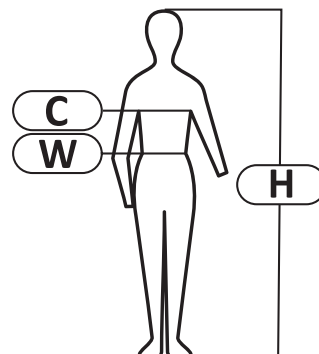

## ПЕРЕЧЕНЬ НОРМ

**EN ISO 13688 - Защитная одежда** - Общие требования. В настоящей Международной Норме определены общие требования, касающиеся изготовления, эргономики, безопасности, обозначения размера, процесса износа, совместимости и маркировки защитной одежды, а также информации, которую должен предоставить производитель вместе с изделием. Настоящая Международная норма предназначена для использования только совместно с другими нормами, устанавливающими требования для конкретного изготовления, и не должна применяться как самостоятельный базовый документ.

**EN ISO 20471 - Одежда повышенной видимости** - Методы испытаний и требования. В стандарте установлены требования к сигнальной одежде, которая обеспечивает визуальное сигнализирование присутствия пользователя в зоне движения для операторов транспортных средств или других механических устройств, в любых условиях освещения, как при дневном свете, так и в темноте, при освещении фарами автомобиля. Стандарт четко определяет требования к цвету и светоотражению, а также минимальным поверхностям и размещению материалов на защитной одежде, кроме этого устанавливает обязанность информировать пользователя о максимальном количестве циклов и способе стирки, которым может быть подвергнута одежда при сохранении соответствующего уровня защиты.

### EN ISO 20471

Стандарт предусматривает разделение одежды на 3 категории на основе минимальных площадей светоотражающих материалов, указанных в м<sup>2</sup>, при этом категория 1 является минимальной категорией, а категория 3 представляет максимальный уровень видимости.

	Одежда категория 3	Одежда категория 2	Одежда категория 1
Материал фона	0.8 м <sup>2</sup>	0.5 м <sup>2</sup>	0.14 м <sup>2</sup>
Светоотражающий материал	0.2 м <sup>2</sup>	0.13 м <sup>2</sup>	0.10 м <sup>2</sup>
Материал с объединенными свойствами	...	...	0.2 м <sup>2</sup>

СИМВОЛ	ОПИСАНИЕ
	Не стирать
	Ручная стирка
	Стирать при температуре 30°C - нормальная стирка
	Стирать при температуре 30°C - деликатная стирка
	Стирать при температуре 30°C - очень деликатная стирка
	Не гладить.
	Гладить при температуре до 110°C
	Гладить при температуре до 150°C
	Гладить при температуре до 200°C
	Не сушить в сушке барабанного типа
	Допускается сушка в барабанной сушилке - сушка при более низкой температуре
	Допускается сушка в барабанной сушилке - нормальная температура
	Сушить на бельевой веревке
	Сушить в расправленном виде
	Сушить не выкручивая
	Не подвергать химчистке
	Профессиональная химчистка в тетрахлорэтилене
	Не хлорировать

## ОДЕЖДА ДЛЯ СВАРЩИКА

Защитная одежда для сварщиков как Средство Индивидуальной Защиты категории II должна быть сертифицирована в процессе оценки типа ЕС на соответствие Директиве 89-686EWG

### НАЗНАЧЕНИЕ

Защитная сварочная одежда требуется при сварочных работах, включающих в себя сварку, наплавку, пайку, точечную сварку и термическую резку металлов и термопластических масс. Во время выполнения сварочных работ сварщики подвергаются опасности ослепления, ожога горячими брызгами металла, воздействию токсичного и канцерогенного дыма и пыли, электромагнитного поля, ультрафиолетового и термического излучения, поражения током, пожара, отравления, заболевания кожи, глаз и легких.

### ТРЕБОВАНИЯ К МАТЕРИАЛАМ

Защитная одежда для сварщиков изготавливается в основном из трудно воспламеняющихся, трикотажных, импрегнированных негорючими веществами с высокой поверхностной массой тканей, а также из натуральной кожи, выделанной с применением негорючих веществ.

### КОНСТРУКЦИОННЫЕ ТРЕБОВАНИЯ

Защитная одежда для сварщиков должна соответствовать определенным требованиям, касающимся конструкции, таким образом, чтобы минимизировать риск попадания горячих брызг под одежду:

- Во время выполнения сварочных работ сварочная одежда должна закрывать все тело пользователя, то есть прикрывать верх и низ туловища, шею, плечи, руки и ноги.
- Если применяемая одежда состоит из блузы и штанов, то низ блузы двухчастного изделия должен заходить на верхний край штанов, создавая закладку шириной не менее 20 см. Такая закладка должна сохраняться во время выполнения всех действий и движений во время работы.
- Части одежды, представляющие собой дополнительные элементы защиты, например, накрытие шеи, капюшон, фартук, защита ступней и перчатки должны быть спроектированы таким образом, чтобы предотвратить попадание искр и капель горячего металла под одежду.
- Если защитная одежда спроектирована с карманами, то их отверстия должны быть закрыты клапанами.
- Если в штанах имеются карманы, то это должны быть только боковые карманы, отверстия которых могут оттопыриваться от бокового шва штанов на угол величиной не более 10°.
- Штаны не должны иметь манжет. Одежда должна быть выполнена таким образом, чтобы она не проводила электрического тока снаружи вовнутрь, например, через металлические застежки.

### КЛАССЫ

Установлены два класса сварочной одежды со строго определенными требованиями к ее эффективности:

**Класс 1:** - защита от менее опасных техник сварки и в ситуациях слабого воздействия брызг расплавленного металла и теплового излучения.

**Класс 2:** - защита от более опасных техник сварки и в ситуациях сильного воздействия горячих факторов.

Одежде вышеуказанных классов приписано, в соответствии с нормой EN ISO 11611 11611, тип применяемого процесса сварки и характеристику действий (тип обслуживаемых машин) выполняемых на данном рабочем месте, что позволяет выполнить подбор соответствующего типа защитной одежды для сварщиков.

Класс одежды	Тип применяемого сварочного процесса	Характеристика действий, выполняемых на данном рабочем месте
Класс 1	Ручные техники сваривания с малой формацией брызг и капель расплавленных металлов, например: <ul style="list-style-type: none"> <li>• газовая сварка,</li> <li>• сварка TIG,</li> <li>• сварка MIG,</li> <li>• микроплазменная сварка,</li> <li>• пайка,</li> <li>• точечная сварка,</li> <li>• сварка MMA (электродом с рутиловым покрытием).</li> </ul>	Обслуживание машин, например: <ul style="list-style-type: none"> <li>• машины для кислородной резки,</li> <li>• машины для плазменной резки,</li> <li>• машины контактной сварки,</li> <li>• Машины для термонапыления,</li> <li>• аппараты для цеховой сварки.</li> </ul>
Класс 2	Ручные техники сварки с большим количеством брызг и капель, например: <ul style="list-style-type: none"> <li>• сварка MMA (электродом с обычным или целлюлозным покрытием),</li> <li>• сварка MAG (в среде CO<sub>2</sub> либо других газовых смесей),</li> <li>• сварка MIG (высоким напряжением тока),</li> <li>• сварка самозащитной стержневой проволокой (порошковой),</li> <li>• плазменная резка,</li> <li>• поверхностная резка,</li> <li>• кислородная резка,</li> <li>• термонапыление.</li> </ul>	Обслуживание машин, например: <ul style="list-style-type: none"> <li>• в ограниченном пространстве,</li> <li>• при сварке/резке над головой либо в подобных вынужденных позициях.</li> </ul>



**ПЕРЕЧЕНЬ НОРМ**



**EN ISO 11611** **Защитная одежда для применения во время сварки и подобных процессов.** Норма определяет основные минимальные требования и методы испытаний защитной одежды, предназначенной для сварщиков либо работников, выполняющих подобные действия, либо действия с подобным уровнем рисков. Этот тип одежды предназначен для защиты пользователя от воздействия брызг расплавленного металла, искр, возникающих во время шлифовки металлов, от кратковременного контакта с огнем и тепловым излучением, исходящим от электрической дуги. Одежда также минимизирует возникновение шока от кратковременного, случайного контакта с электрическим проводом, находящимся под напряжением до 100В, в нормальных условиях и во время сварки. Процедура A1 - метод испытания воспламенения поверхности Процедура A2 - метод испытания воспламенения края Выполненные A1 + A2 - ограниченное распространение пламени.



**EN ISO 11612** **Защитная одежда - Одежда для защиты от горячих факторов и пламени - Минимальные эксплуатационные требования.** Норма определяет требования к одежде, предназначенной для защиты тела пользователя, за исключением рук, от горячих факторов и пламени. В норме представлены требования к широкой группе защитной одежды, которая должна отличаться стойкостью к воспламенению при кратковременном контакте с огнем, ограничивая распространение пламени (A1 + A2) и защищать, по крайней мере, от одного из видов горячих факторов. Уровни эффективности защиты от горячих факторов (большая цифра обозначает высший уровень защиты):

- конвекционное тепло (B1, B2, B3)
- тепловое излучение (C1, C2, C3, C4)
- брызги расплавленного алюминия (D1, D2, D3)
- брызги расплавленного железа (E1, E2, E3)
- контактное тепло (F1, F2, F3)

**АНТИЭЛЕКТРОСТАТИЧЕСКАЯ ОДЕЖДА**

Защитная антиэлектростатическая одежда, как Средство Индивидуальной Защиты II категории, должна быть сертифицирована в процессе оценки типа ЕС на предмет соответствия Директиве 89/686EWG.

**ПЕРЕЧЕНЬ НОРМ**



**EN 1149-5** **Защитная одежда - Электростатические свойства - Часть 2: Требования к конструкции и материалам.** Норма определяет методы испытания электростатических свойств материалов и конструкционные требования, касающиеся защитной одежды, рассеивающей электростатический разряд, используемой в качестве элемента единой системы заземления, с целью предотвращения возникновения разрядов, могущих привести к воспламенению. Эти требования могут оказаться недостаточными в случае наличия огнеопасной атмосферы, обогащенной кислородом. Одежда, рассеивающая электростатический заряд, называется также антиэлектростатической одеждой.

**НАЗНАЧЕНИЕ**

Ношение защитной антиэлектростатической одежды требуется в зонах угрозы взрыва (например, химическая, горнодобывающая, нефтедобывающая промышленность, транспортировка опасных веществ, газовая промышленность, электростанции и т.п.), а также вне зон угрозы (например, в производстве электронных элементов с целью их защиты от воздействия электростатического разряда).

**ТРЕБОВАНИЯ К МАТЕРИАЛАМ**

Защитная электростатическая одежда выполнена из материалов, отличающихся способностью к рассеиванию и отводу электростатического заряда, что предотвращает возникновение электростатического разряда, способного вызвать воспламенение.

**КОНСТРУКЦИОННЫЕ ТРЕБОВАНИЯ**

Антиэлектростатическая одежда должна соответствовать установленным требованиям, касающимся конструкции, таким образом, чтобы предотвратить возникновение электростатических разрядов:

- Одежда, во время ее использования, должна закрывать все тело, как во время передвижения, так и во время наклонов.
- Одежда должна быть соответственно подогнана к телу, а также обеспечивать свободу движения в ситуации, если она должна быть постоянно застегнута в ходе использования.
- Если одежда изготовлена из системы материалов, то электростатическая ткань должна составлять ее внешний слой.
- Застежки из электропроводящих материалов, например, застежки-молнии, пуговицы, замки могут быть использованы только при условии, если они покрыты антиэлектростатическим материалом.
- В случае материалов, содержащих антиэлектростатическую пряжу в виде параллельных нитей или сетки, расстояние между электропроводящими нитями в одном направлении не должно превышать 10 мм.



PROLINE  
LANTI PRO  
MEGA  
JUCO  
OTHER BRANDS  
ERDI  
KLINGSPOR  
EXPRESS  
ACTION CAN  
TRYTON  
VULCAN

## ■ ЗАЩИТА ОТ ПАДЕНИЯ С ВЫСОТЫ

Работа на высоте означает, в частности, работу на лесах, строительных конструкциях, потолочных перекрытиях, дымоходах, лестницах либо других возвышениях, находящихся на высоте не менее 1,0 м над уровнем окружающей территории, либо над уровнем пола.

К работам на высоте не относятся работы на площадке, независимо от того, на какой высоте находится работник, если она ограждена со всех сторон полными стенками высотой не менее 1,5 м (в том числе с окнами) либо снабжена другими стационарными устройствами или конструкциями, предохраняющими работника от падения с высоты.

Положения польского и европейского законодательства в области безопасности и гигиены труда обязывают работодателей, принимающих на работу специалистов, выполняющих работы на высоте, обеспечивать им соответствующие средства предохранения от падения.

Падение с высоты часто является причиной несчастных случаев, зачастую тяжелых либо смертельных. Работы на высоте относятся к видам особо опасных работ, представляющих опасность для жизни и здоровья работников, поэтому средства индивидуальной защиты, входящие в эту группу, мы причисляем к III категории. Во время выполнения работ на высоте должны предприниматься исключитель-

ные меры предосторожности вследствие высокой степени угрозы здоровью и жизни работников. Для выполнения работ на высоте могут быть допущены исключительно работники, которые:

- ознакомлены с профессиональными рисками, связанными с выполняемой работой
- имеют гарантированные средства индивидуальной защиты, позволяющие выполнять такую работу
- имеют актуальное медицинское освидетельствование, подтверждающее отсутствие противопоказаний для работ на высоте
- прошедшие курс специальной подготовки в области БГТ и инструктаж, ознакомляющий их с спецификой работ на высоте и с угрозами, возникающими на рабочем месте.

В соответствии с требованиями гармонизированной нормы PN-EN 365 «Средства индивидуального предохранения от падения с высоты. Общие требования, касающиеся инструкции пользования, консервации, периодических техосмотров, ремонтов, маркировки и упаковки», следует выполнять ежегодно, от момента начала использования оснащения.

Для того, чтобы соответствовать требованиям правил, все комплекты, предназначенные для работы на высоте, должны состоять из:

**Лямок безопасности (EN 361)** - основной задачей лямок является удерживание тела человека во время падения и безопасное разложение динамических сил, сопутствующих препятствованию падению. Только полные лямки безопасности, снабженные ремнями, охватывающими плечи и бедра, являются приспособлениями, допущенными к использованию в качестве средств предохранения от падения.

**Точки якорного зацепления (EN 362)** - являющейся первым и ключевым звеном системы предохранения от падения. Ее задачей является зацепление соединяюще-амортизирующего подузла с несущей конструкцией.

**Соединительно-амортизирующего элемента (EN355)** - соединяет застежку зацепления лямок безопасности с пунктом зацепления. В случае, если произойдет падение, амортизирующе-соединительный подузел должен задержать падение и сгладить силу, возникающую во время падения. Функции соединительно-амортизирующего узла могут выполнять: амортизаторы с тросом безопасности, самотормозящие и самозажимающие устройства, а также другие защитные приспособления.

### ПЕРЕЧЕНЬ НОРМ

#### (EN362)

В норме установлены требования и методы испытаний для зацепных якорных устройств, предназначенных для одного и нескольких пользователей. В норме также указаны требования к маркировке, руководства по эксплуатации и рекомендации по установке.

#### (EN355)

В норме установлены требования, методы испытаний, правила маркировки, указана информация, которую требуется довести к сведению пользователя, а также способ упаковки амортизаторов.

#### (EN361)

В норме установлены требования, методы испытаний, правила маркировки, указана информация, требуемая от производителя, а также способ упаковки лямок безопасности.



# ЗАЩИТА НОГ



Обеспечение соответствующей защиты ног и стоп имеет решающее влияние, прежде всего, на безопасность во время работы, а также на комфорт пользования. Обувь с защитными свойствами предназначена для защиты ступней пользователя от травм, которые можно получить вследствие несчастного случая. Обувь может предохранить ступни от воздействия механических и химических факторов, тепла, холода и влаги. Обувь защищает, как правило, от нескольких видов угроз одновременно. Степень защиты зависит в основном от конструкции обуви, материалов ее изготовления и оснащения такими элементами, как: подноски, уплотнительные стельки, защита щиколотки и т.п. Обувь, не обладающая защитными свойствами, а предназначенная только для использования на рабочем месте вследствие своих гигиенических свойств, не может считаться средством индивидуальной защиты, а только рабочей обувью.

## КОНСТРУКЦИЯ ОБУВИ



## ПЕРЕЧЕНЬ НОРМ

**EN ISO 20345 - Средства индивидуальной защиты - Безопасная обувь.** В норме определены основные и дополнительные (опция) требования для безопасной обуви, используемой для общих целей. Приняты во внимание, например, механический риск, стойкость к скольжению, термическим угрозам, эргономические свойства. Безопасная обувь (SB, S1 – 4) - имеет защитные свойства вместе с защитой пальцев стопы с помощью подносков, прочность которых испытывается при ударе с энергией 200 Дж.

**EN ISO 20347 - Средства индивидуальной защиты - Профессиональная обувь.** В норме определены основные и дополнительные требования к профессиональной обуви. Указания, касающиеся специальных угроз, содержатся во вспомогательных нормах, применимых к обуви для специальных работ (например, обувь для пожарных, электроизоляционная обувь). Профессиональная обувь (OB, O1 – 5) - обладает защитными свойствами, предназначенными для защиты от травм, которые могут возникнуть во время несчастного случая на рабочих местах. Она предназначена для ежедневного использования, когда необходима защита пальцев стопы с помощью подносков.

## МАРКИРОВКА ОБУВИ

- размер
- товарный знак

Labels on the shoe label:

- LAHTI PRO®
- SIZE 42
- ROZMIAR
- S1P SRA
- ISO 20345:2011
- Rok produkcji: 2018/III
- 00305/01/18/ZDI
- PROFIX Sp. z o.o.
- ul. Marywilska 34, 03-228 Warszawa, Polska
- www.lahtipro.com
- L3010442
- www.lahtipro.com

- маркировка модели производителя
- серийный номер
- дата изготовления – год и квартал
- номер нормы
- знак CE
- категория безопасности и маркировка дополнительными символами в зависимости от наличия дополнительного защитного свойства



PROLINE  
LAHTI PRO  
MEGA  
JUCO  
OTHER BRANDS  
ERDI  
KLINGSPOR  
EXPRESS  
ACTION CAN  
TRYTON  
VULCAN



## КАТЕГОРИИ ЗАЩИТЫ ОБУВИ - ОСНОВНЫЕ ТРЕБОВАНИЯ

### Категории безопасной обуви (EN ISO 20345)

Категория защиты	Подносок, предохраняющий пальцы от ударов с энергией 200 Дж	Стойкость к воздействию дизельного топлива	Абсорбция энергии в области пятки	Антиэлектростатические свойства	Встроенный подпятник	Стойкость к проколам с силой до 1100 Н	Ограниченная влагопроницаемость и влагопоглощение воды	Класс
SB								I
S1								I
S2								I
S3								I
S4*								* II (обувь из материала цельной формовки)
S5*								* II (обувь из материала цельной формовки)

### Категории профессиональной обуви (EN ISO 20347)

Категория защиты	Подносок, предохраняющий пальцы от ударов с энергией 200 Дж	Стойкость к воздействию дизельного топлива	Абсорбция энергии в области пятки	Антиэлектростатические свойства	Встроенный подпятник	Стойкость к проколам с силой до 1100 Н	Ограниченные влагопроницаемость и поглощение воды	Класс
OB	x	x						I
O1	x	x						I
O2	x	x						I
O3	x	x						I
O4*	x	x						* II (обувь из материала цельной формовки)
O5*	x	x						* II из материала цельной формовки)

## КАТЕГОРИИ ЗАЩИТЫ ОБУВИ - ДОПОЛНИТЕЛЬНЫЕ ТРЕБОВАНИЯ

Символ	Дополнительное требование
P	Стойкость подошвы к прокалыванию с силой 1100 Н
A	Антиэлектростатические свойства
C	Токопроводящие свойства
I	Электроизоляционные свойства
HI	Теплоизоляционные свойства подошвы
CI	Изоляция подошвы от холода
E	Поглощение энергии в области пятки
WR	Ограниченная влагопроницаемость всей обуви
WRU	Ограниченная влагопроницаемость и влагопоглощение верхней части обуви
HRO	Стойкость подошвы к воздействию высокой температуры при кратковременном контакте (до 300°C±5°C/ 1мин±1с)
CR	Стойкость к порезам
M	Защита плюсны
AN	Защита щиколотки
FO	Стойкость подошвы к воздействию солянки
SRA	Стойкость к скольжению по керамическому полу, покрытому раствором лаурилсульфата натрия (SLS)
SRB	Стойкость к скольжению по стальному полу, покрытому глицеролом
SRC	Стойкость к скольжению по обоим вышеуказанным полам





RECHTSGRUNDLAGEN

**Verordnung (EU) 2016/425 des Europäischen Parlaments und des Rates vom 9. März 2016 über persönliche Schutzausrüstungen und zur Aufhebung der Richtlinie 89/686/EWG des Rates.**

In Übereinstimmung mit den Gesetzen der Europäischen Union (Richtlinie 89/686/EWG vom 21. Dezember 1989 in Bezug auf persönliche Schutzausrüstungen, Verordnung (EU) 2016/425 des Europäischen Parlaments und des Rates vom 9. März 2016 über persönliche Schutzausrüstungen und zur Aufhebung der Richtlinie des Rates. (89/686/EWG) und den nationalen Rechtsvorschriften im Bereich Arbeitsschutz und Arbeitsgesetzbuch ist es die Pflicht eines jeden Arbeitgebers, seine Angestellten mit persönlicher Schutzausrüstung zu versorgen, die entsprechend für den Schutz vor den auf der gegebenen Arbeitsstelle vorkommenden Gefährdungen angepasst ist.

**„Persönliche Schutzausrüstung ist ein Gerät oder eine Ausrüstung, die zum Tragen oder Halten durch den Nutzer vorgesehen ist und dem Schutz vor einer oder mehreren Gefährdungen dient, die Einfluss auf die Sicherheit oder Gesundheit haben können.“**

**Persönliche Schutzausrüstung**

ist ein recht weiter Begriff, denn sie dient nicht nur dem Schutz der Arbeitnehmer am Arbeitsplatz, sondern umfasst ebenfalls die Verwendung bei Aktivitäten, die nicht mit der Arbeit verbunden sind, wie beispielsweise Sport und Freizeit. Weitere Beispiele sind: Ausrüstung, die die Sichtbarkeit sicherstellt, und Schutzkleidung mit intensiver Sichtbarkeit für außerberufliche Nutzung. Hersteller persönlicher Schutzausrüstung sind vor deren Inverkehrbringen dazu verpflichtet, die Übereinstimmung mit

KATEGORIEN DER PERSÖNLICHEN SCHUTZAUSRÜSTUNG

Die PSA-Verordnung unterteilt persönliche Schutzausrüstung in drei Kategorien, je nach Risiken, denen der Arbeiter während der Ausführung der Arbeit ausgesetzt sein kann:

Schutzklasse	Risikograd	Beschreibung
I	Niedrig	Produkte dieser Kategorie bieten einen grundlegenden Schutz gegen äußere Faktoren mit einem niedrigen Risikograd, deren Auswirkungen oberflächlich sind, und schützen beispielsweise vor kleinen Schnittverletzungen, Abschürfungen, Verschmutzungen, Einwirkungen milder Reinigungsmittel, Witterungsbedingungen und vor dem Kontakt mit heißen Oberflächen mit einer Temperatur, die 50°C nicht überschreitet, sowie Augenschäden durch Sonneneinstrahlung (ausgenommen sind Beschädigungen, die während der Beobachtung der Sonne entstehen) usw.
II	Mittel	Produkte dieser Kategorie werden für den Schutz unter Bedingungen eingesetzt, deren Risikograd nicht als niedrig oder hoch klassifiziert wurde.
III	Hoch	Kategorie III umfasst nur Gefahren, die sehr schwerwiegende Folgen haben können, wie Tod oder irreversible Gesundheitsschäden und verbunden sind mit Stoffen und Gemischen, die eine Gefahr für die Gesundheit darstellen, einer Atmosphäre mit Sauerstoffmangel, schädlichen biologischen Faktoren, ionisierender Strahlung, einer Umgebung mit hohen Temperaturen, deren Auswirkungen vergleichbar sind mit der Auswirkung von Luft bei einer Temperatur von mindestens 100°C, einer Umgebung mit niedrigen Temperaturen, deren Auswirkungen vergleichbar sind mit der Auswirkung von Luft bei einer Temperatur von -50°C oder niedriger, einem Sturz aus der Höhe, einem Stromschlag und Arbeit an spannungsführenden Teilen, Ertrinken, Schnittverletzungen durch tragbare Kettensägen, Hochdruckdüsen, Schussverletzungen oder Messerstiche, schädlichem Lärm usw.

Polnisches Arbeitsgesetzbuch

„Arbeitsgeber dürfen Arbeitnehmer ohne persönliche Schutzausrüstung und Arbeitskleidung und Arbeitsschuhe, deren Verwendung vorgesehen ist für den gegebenen Arbeitsplatz, nicht zur Arbeit zulassen.“  
(Arbeitsgesetzbuch Art. 2379 § 1)

„Arbeitgeber sind dazu verpflichtet, Arbeitnehmern persönliche Schutzausrüstung zur Verfügung zu stellen, die die Anforderungen hinsichtlich der Konformität mit den gesonderten Rechtsvorschriften erfüllen.“  
(Arbeitsgesetzbuch Art. 2376 § 3)



PROLINE  
LAHTI PRO  
MEGA  
JUCO  
OTHER BRANDS  
ERDI  
KLINGSPOR  
EXPRESS  
ACTION CAN  
TRYTON  
VULCAN

## Vor der Auswahl der entsprechenden persönlichen Schutzausrüstung muss folgendes durchgeführt werden:

- Risikograd muss definiert werden
- Gefährdungsart muss bestimmt werden
- Art der Gefährdung muss festgelegt werden
- Produkt mit den bestimmten Schutzparametern auswählen

## Aufteilung der PSA in die einzelnen Gruppen:

The diagram illustrates a worker in full personal protective equipment (PSA) with callouts to various equipment groups:

- KOPFSCHUTZ**: Two hard hats, one orange and one red.
- AUGEN- UND GESICHTSSCHUTZ**: Safety glasses, a white face shield, and a silver helmet with a visor.
- GEHÖRSCHUTZ**: A pair of red earmuffs and a pair of yellow earplugs.
- ATEMSCHUTZ**: A white respirator mask and a blue respirator mask.
- KÖRPERSCHUTZ**: A blue and grey work jacket, a tan work jacket, a pair of blue and black work pants, and a pair of tan work pants.
- HANDSCHUTZ**: A pair of blue and black work gloves, a pair of black and red work gloves, and a pair of purple work gloves.
- HÖHENARBEITEN**: A red safety harness and a red safety lanyard.
- BEINSCHUTZ**: A pair of black and yellow work boots, a pair of tan work boots, and a pair of black and grey work boots.

## ■ AUGEN- UND GESICHTSSCHUTZ

Persönliche Schutzausrüstung für den Schutz der Augen und des Gesichtes schützt vor Augen- und Gesichtsverletzungen, die durch mechanische, chemische und biologische und thermische Faktoren oder durch schädliche Strahlungen verursacht werden.

Persönliche Schutzausrüstung für den Augen- und Gesichtsschutz für die professionelle Anwendung sollte überall dort eingesetzt werden, wo folgende Gefährdungen auftreten:



Schläge  
(z. B. Absplitterungen  
von Festkörpern)



Tropfen und Spritzer  
von Flüssigkeiten  
(z. B. Spritzer, die  
während dem Umschütten  
von Flüssigkeiten entstehen)



optische Strahlung  
(z. B. Strahlung,  
die bei Schweiß-  
prozessen entsteht,  
Sonnenblendung).



Geschmolzene Metalle  
und heiße Festkörper (z. B.  
Spritzer von geschmolzenem  
Metall, die bei Hochofen-  
prozessen entstehen)



Staub und Gase (z. B.  
Kohlenstaub oder  
Aerosole von chemi-  
schen Schadstoffen)



Lichtbogen (z. B.  
bei der Ausführung  
von Arbeiten an  
spannungsfüh-  
renden Teilen)

Persönliche Schutzausrüstung für den Augen- und Gesichtsschutz für die professionelle Anwendung wird in drei Kategorien unterteilt:



Brillen und Googles



Gesichtsschutz



Schweißschutz (zu dieser  
Kategorie gehören Schilde,  
Googles und Schweißschutzhauben)

### VERZEICHNIS DER NORMEN:

**EN 166** - Persönlicher Augenschutz. – Anforderungen.  
Durch die Norm werden die Funktionsanforderungen für verschiedene Arten von persönlichem Augenschutz festgelegt.

**EN 169** - Persönlicher Augenschutz – Filter für das Schweißen und Filter für verwandte Techniken - Anforderungen an den Transmissionskoeffizienten und empfohlene Anwendung. In der Norm werden die Kennzeichnungen für Filter und die Anforderungen zu den Transmissionskoeffizienten für die Filter zum Schutz von Nutzer festgelegt, die Arbeiten ausführen, die Schweißarbeiten, Elektro-Luft-Kerbungen und Plasmaschneiden erfordern.

**EN 170** - Persönlicher Augenschutz – Ultraviolettfilter  
– Anforderungen an den Transmissionskoeffizienten und empfohlene Anwendung. In der Norm sind die Prinzipien für die Kennzeichnung, Identifizierung, Auswahl und Nutzung der Filter enthalten. In der Norm werden die Anforderung zum Transmissionskoeffizienten von Ultraviolettfiltern festgelegt.

**EN 172** - Persönlicher Augenschutz – Schutzfilter für Sonnenblendungen für den betrieblichen Gebrauch. In der Norm werden die Kriterien für die Auswahl, Kennzeichnung und den Transmissionskoeffizienten bestimmt und die entsprechenden Methoden für die Prüfung der Filter für den Schutz vor Sonnenblendungen festgelegt

**EN 1731** - Persönlicher Augenschutz – Augen- und Gesichtsschutzgeräte aus Gewebe. In der Norm werden verwendete Materialien, Entwurfsmethoden, Anforderungen, Prüfmethode und Kennzeichnungen von persönlichen Augen- und Gesichtsschutzgeräte aus Gewebe für den Schutz vor mechanischen Gefährdungen beschrieben.

**EN 175** - Persönlicher Schutz – Geräte für Augen- und Gesichtsschutz beim Schweißen und bei verwandten Verfahren. In der Norm werden die Sicherheitsanforderungen und Prüfmethode für persönliche Schutzausrüstung für Augen und Gesicht vor schädlichen optischen Strahlungen und anderen spezifischen Risiko- oder Gefährdungsquellen beschrieben, die normalerweise beim Schweißen, Schneiden und verwandten Verfahren auftreten.



BRILLEN UND GOOGLES

Die Kennzeichnung der Brillen und Googles dient der Identifikation und korrekten Auswahl entsprechend zu den Gefährdungen auf dem gegebenen Arbeitsplatz.

**Scheiben** (Brillengläser) und **Brillenfassungen** (Rahmen) müssen separat gekennzeichnet werden. Falls diese jedoch eine nicht auseinandernehmbare Einheit bilden, müssen alle erforderlichen Kennzeichnungssymbole auf der Fassung (Rahmen) angebracht werden.

KENNZEICHNUNG VON BRILLEN UND GOOGLES



CE 5-3.1 XX 1 FT

KENNZEICHNUNG DER SCHEIBEN

- CE-Zeichen
- Filterart (von 2 bis 6)
- Verdunklungsgrad (von 1,2 bis 16)
- Identifikationszeichen des Herstellers
- Optische Klasse (von 1 bis 3)
- Symbol der mechanischen Festigkeit („S“, „F“, „B“, „A“)
- Symbol der zusätzlichen Schutzigenschaften („K“, „N“, „R“, „T“)

KENNZEICHNUNG DER FASSUNGEN



CE XX EN 166 F

- CE-Zeichen
- Identifikationszeichen des Herstellers
- Nummer der Norm
- Symbol der mechanischen Festigkeit („S“, „F“, „B“, „A“)

GEN- UND GESICHTSSCHUTZKLASSE – MECHANISCHE VERLETZUNGEN

PARAMETER	BRILLEN	GOOGLES	GESICHTSSCHUTZ
Erhöhte Stoßbeständigkeit (5,1m/s) – Kennzeichnung S	+	+	+
Beständigkeit gegen Stößen mit niedriger Energie (45m/s) – Kennzeichnung F	+	+	+
Beständigkeit gegen Stößen mit mittlerer Energie (120 m/s) – Kennzeichnung B	-	+	+
Beständigkeit gegen Stößen mit hoher Energie (190 m/s) – Kennzeichnung A	-	-	+

**Filterart Strahlungsschutz:**

2	Ultraviolettfilter (UV)
2C oder 3	Ultraviolettfilter (UV), gute Farberkennung
4	Infrarotfilter (IR)
5	Sonnenschutzfilter (Sonnenschutz) ohne Anforderungen in Bezug auf Infrarotstrahlung
6	Sonnenschutzfilter (Sonnenschutz) mit Anforderungen in Bezug auf Infrarotstrahlung

**Grad der Verdunkelung Koeffizient der Lichttransmission**

1.2	100 – 74.4 %
1.4	74.4 – 58.1%
1.7	58.1 – 43.2%
2.0	43.2 – 29.1%
2.0	43.2 – 29.1%
2.5	29.1 – 17.8%
3.1	17.8 – 8.0%
4.1	8.0 – 3.0%
...	
16	0.000061 – 0.000023%

**Optische Klasse:**

- 1 für ständige Anwendung
- 2 für gelegentliche Anwendung
- 3 für kurze Anwendung

- Symbole der mechanischen Festigkeit**
- S** Stoß mit erhöhter Energie - beständig gegen Stoß einer Stahlkugel mit einem Nenndurchmesser von 22 mm und einer Masse von 43g bei einer Geschwindigkeit von 5,1m/s
  - F** Stoß mit niedriger Energie - beständig gegen Stoß einer Stahlkugel mit einem Nenndurchmesser von 6 mm und einer Masse von 0,86g bei einer Geschwindigkeit von 45m/s
  - B** Stoß mit mittlerer Energie - beständig gegen Stoß einer Stahlkugel mit einem Nenndurchmesser von 6 mm und einer Masse von 0,86g bei einer Geschwindigkeit von 120m/s
  - A** Stoß mit großer Energie - beständig gegen Stoß einer Stahlkugel mit einem Nenndurchmesser von 6 mm und einer Masse von 0,86g bei einer Geschwindigkeit von 190m/s (angewendet im Fall von Gesichtsschutz).

- Symbole der Anwendungsgebiete (angewendet im Fall von Googles)**
- 3 Schutz vor Flüssigkeiten (in Form von Tropfen und Spritzern)
  - 4 Schutz vor groben Staubteilchen (größer als 5 µm)
  - 5 Schutz vor Gasen und feinen Staubteilchen (Dunst, Nebel, Rauch und Staub mit einer Körnchengröße von unter 5 µm)
  - 8 Schutz vor Lichtbögen, die durch Kurzschlüsse entstehen
  - 9 Schutz vor geschmolzenen Metall und dem Durchdringen heißer Festkörper

- Symbole der zusätzlichen Schutzigenschaften**
- K** Oberflächenbeständigkeit gegen Beschädigung durch kleine Staubteilchen
  - N** Beständigkeit gegen Beschlagen
  - R** erhöhter Reflektionsgrad
  - T** Schutz vor Partikeln in extremen Temperaturbedingungen. Beständigkeit wird zwischen -5°C - 55°C sichergestellt

PROLINE  
LAHTI PRO  
MEGA  
JUCO  
OTHER BRANDS  
ENJO  
KLINGSPOR  
EXPRESS  
ACTION CAN  
TRITON  
VALCAN

GESICHTSSCHUTZ

Der Gesichtsschutz schützt das Gesicht und die große Schutzfläche reduziert die Wahrscheinlichkeit, dass gefährliche Spritzer in das Innere eindringen. Gesichtsschutz kann ebenfalls zusammen mit Brillen (Schutz- oder Korrekturbrillen), Googles oder einigen Atemschutzgeräten verwendet werden.

Die Schutzausrüstung wird direkt auf dem Kopf des Nutzers oder auf dem Schutzhelm angebracht. Die Scheiben solcher Arten von Abschirmungen bestehen normalerweise aus in der Masse eingefärbten Polycarbon oder aus Polycarbon mit aufgetragenen Beschichtungen, die die Wärmestrahlung reflektieren und dort angewendet werden, wo die Wärmestrahlung besonders hoch ist.

KENNZEICHNUNG VON GESICHTSSCHUTZ



- Identifikationszeichen des Herstellers, Kennzeichnung des Modells
- Nummer der Norm
- Optische Klasse
- Mechanische Festigkeit
- Schutz vor Partikeln mit großen Geschwindigkeiten
- Schutz gegen Spritzer von Flüssigkeiten
- CE-Zeichen

SCHWEISSERSCHUTZ

Schweißhelme und Schweißschilde werden beim Lichtbogenschweißen oder bei der Elektrokerbung, beim Schneiden mit Sauerstoff oder Plasmastrahl angewendet. Schweißhelme können mit einem einzelnen Schweißfilter oder zwei Schweißfiltern ausgestattet sein, wobei einer der Filter nur als Visierfilter und der zweite Filter ist der eigentliche, dunklere Filter, der für die Ansicht während der Schweißarbeiten verwendet wird.

Es werden ebenfalls Schweißhelme verwendet, die mit automatischen Schweißfiltern ausgestattet sind. Diese Filter verdunkeln das Sichtfeld automatisch, wenn beispielsweise ein Lichtbogen oder Plasmabogen beobachtet wird, und das Sichtfeld wird, nachdem der Bogen verschwindet (im Tempo der Abkühlung der Schweißnähte), automatisch aufgehellt.

Zusätzlich können Schweißhelme mit Belüftungssystemen ausgestattet sein, die Luft aus dem Bereich des Hinterkopfs des Schweißers zuführen, wodurch eine deutliche Reduktion des eingeatmeten Rauchs aus den Schweißarbeiten (Staub und Gase) bewirkt wird, oder sie können mit einer Halterung für die Montage von Filtergeräten mit erzwungenem Luftdurchfluss ausgestattet sein.

Schweißschilde sind für den Schutz der Augen, des gesamten Gesichts und des Halses des Schweißers vorgesehen. Die grundlegende Einschränkung des Schweißschildes ist, dass es während des Schweißens in der Hand gehalten werden muss, was die Bewegungsfreiheit des Arbeiters erheblich eingrenzt, z. B. wird das Halten des geschweißten Gegenstandes verhindert.

KENNZEICHNUNG VON SCHWEISSERSCHUTZ



- Identifikationszeichen des Herstellers, Kennzeichnung des Modells
- Nummer der Norm
- CE-Zeichen

Auswahl des Schweißfilters gemäß EN169/EN175

PROZESS	STROM [A]																								
	1.5	6	10	15	30	40	60	70	100	125	150	175	200	225	250	300	350	400	450	500	600				
Elektrode mit Umhüllung	8				9				10				11				12				13				14
MAG	8				9				10				11				12				13				14
TIG	8				9				10				11				12				13				14
MIG Schwermetalle					9				10				11				12				13				14
MIG Leichtmetalle									10				11				12				13				14
Elektro-Luft-Kerbung					10								11				12				13				14
PAC									9				10				11				12				13
PAW	4	5	6	7	8	9	10	11	12	13	14	15	16	17	18	19	20	21	22	23	24				

- **MIG** - Schweißen mit Schmelzelektroden mit Inertgasumhüllung
- **MAG** - Schweißen mit Schmelzelektroden mit Aktivgasumhüllung
- **TIG** - Wolfram-Inertgas-Schweißen
- **Elektro-Luft-Kerbung** - mit Verwendung einer Kohlenelektrode und Druckluft für das Wegblasen des geschmolzenen Metalls
- **PAC** - Schneiden mit Plasmastrahl
- **PAW** - Schweißen mit Mikroplasmabogen

# KOPFSCHUTZ

## KENNZEICHNUNG DER HELME

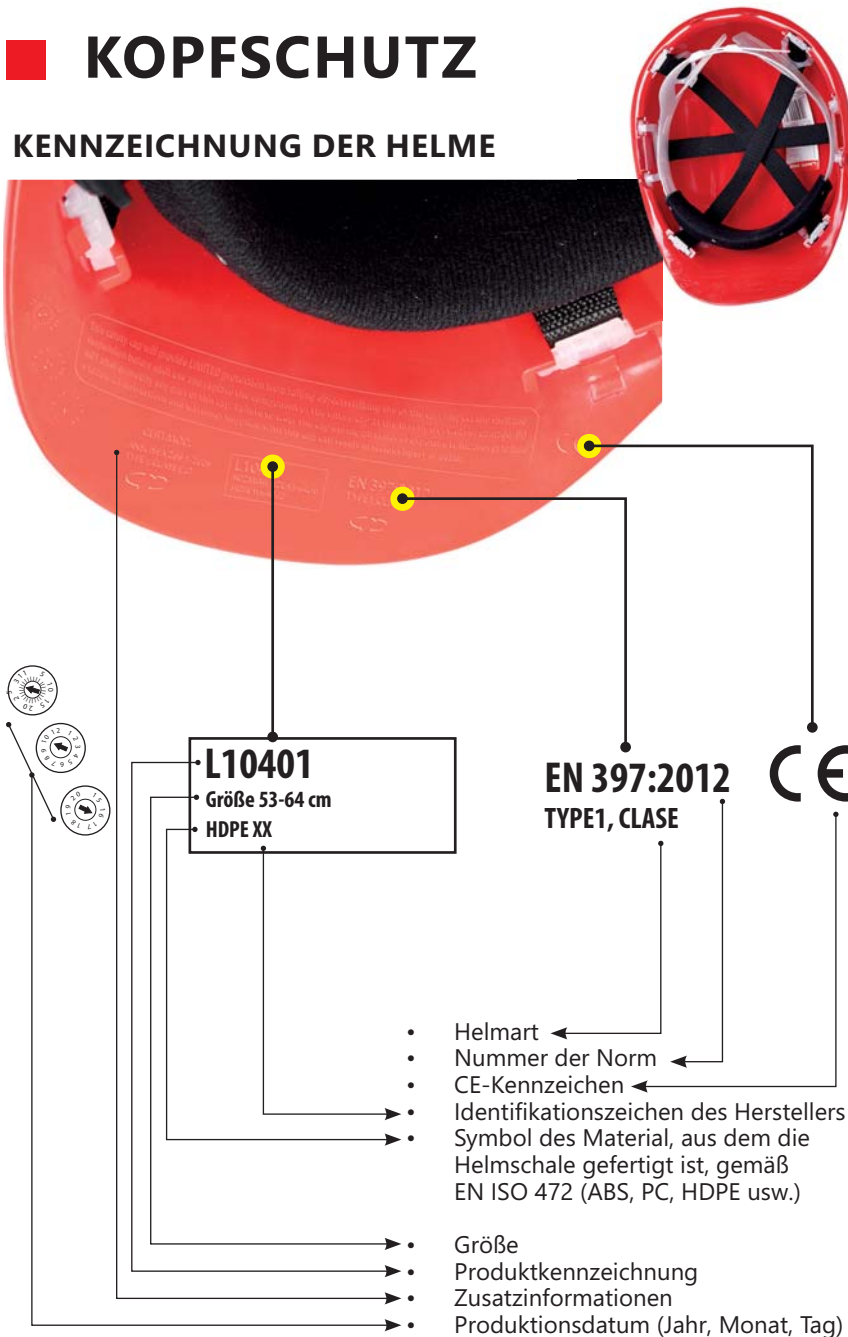

## VERZEICHNIS DER NORMEN

### EN 397 - Industrieschutzhelme.

Durch die Norm werden die Konstruktionsanforderungen und Schutzparameter, die Prüfmethode und Anforderungen zur Kennzeichnung der Industrieschutzhelme festgelegt. Es wurden Pflichtenforderungen und zusätzliche Anforderungen für die Schutzparameter festgelegt.

#### Pflichtenforderungen

- **Dämpfungsvermögen** (Die auf das Kopfmodell geleitete Stoßenergie darf beim Fall Schlagpendels mit einer Masse von 5 kg aus einer Höhe von 1 m nicht 5 kN überschreiten)
- **Durchdringungsfestigkeit** (Ein Durchschlagpendel mit einer Masse von 3 kg aus einer Höhe von 1 m darf keine Verformungen des Helms verursachen, die zu einem Kontaktpunkt mit dem Kopfmodell führen)
- **Flammbeständigkeit** (Der Strahl eines Brenners muss mit einem Winkel von 45 Grad von der Senkrechten und in einer Entfernung von 50 bis 100 mm mit dem Gipfel der Schale 10 Sekunden lang in Berührung gebracht werden. Die Helmschale darf nicht länger als 5 Sekunden nach dem Abstellen der Flamme weiterbrennen und die Flammen verbreiten)

#### Zusätzliche Anforderungen:

- Dämpfungsvermögen unter sehr niedrigen Temperaturen von -20°C oder -30°C
- Dämpfungsvermögen unter sehr hohen Temperaturen von + 150°C
- elektrische Isolierung - 440 Vac
- Gestaltfestigkeit bei seitlicher Beanspruchung - **LD**
- Schutz gegen Spritzer von geschmolzenem Metall - **MM**

## Lebensdauer der Helme

Das Produktionsdatum der Helme wird auf der Schaleninnenseite eingepreßt (normalerweise auf dem Schirm). Es wird mittels drei Scheiben kodiert. Die Spitze des Pfeils in der Mitte von jeder der Scheiben zeigt entsprechend folgende Information an: Jahr, Monat und Tag der Produktion. Die vollständigen Schutzeigenschaften des Helms sind 2 Jahre lang ab dem Datum des Nutzungsbegins gegeben, jedoch nicht länger als 3 Jahre ab dem Produktionsdatum.

# GEHÖRSCHUTZ

## VERZEICHNIS DER NORMEN

**EN352-1** - Gehörschützer - Allgemeine Anforderungen - Teil 1: Kapselgehörschützer. Durch die Norm werden die Anforderungen zur Konstruktion, zum Entwurf, zur Funktion, Kennzeichnung und den Informationen für den Nutzer der Kapselgehörschützer festgelegt.

**EN352-2** - Gehörschützer - Allgemeine Anforderungen - Teil 2: Lärmschutzstöpsel. Durch die Norm werden die Anforderungen zur Konstruktion, zum Entwurf, zur Funktion, Kennzeichnung und den Informationen für den Nutzer der Gehörschutzstöpsel festgelegt.

**EN352-3** - Gehörschützer - Allgemeine Anforderungen - Teil 3: An Industrieschutzhelmen befestigte Kapselgehörschützer. Durch die Norm werden die Anforderungen zur Konstruktion, zum Entwurf, zur Funktion, Kennzeichnung und den Informationen für den Nutzer der an Industrieschutzhelmen befestigten Kapselgehörschützer festgelegt.

## Allgemeine Parameter der Norm EN352

- **Anpassungsmöglichkeit** - bewertet wird die Möglichkeit zur Anpassung der Kapselgehörschützer an Köpfe mit verschiedenen Größen
- **Andrückkraft des Bügels** - die maximale Andrückkraft des Bügels beträgt 14 N
- **Andrückkraft der Dichtungskissen** - die maximale Andrückkraft der Dichtungskissen beträgt 4500 Pa
- **Beschädigungsbeständigkeit** - das Produkt wird aus einer Höhe von 1,5 Meter auf eine Stahlplatte fallen gelassen
- **Entflammbarkeit** - die Oberfläche des Produkt wird mit einem auf 650°C ± 20°C erhitzten Stab 5 Sekunden berührt; die Oberfläche darf nach dem Entfernen des Stabs nicht entflammen oder glühen.

**ANFORDERUNGEN DER RICHTLINIE 2003/10/EG**

Mindestanforderungen zum Schutz der Arbeiter vor durch Lärm verursachte Gefahren

Exposition während 8 Stunden auf $\geq 85$ dB	Exposition während 8 Stunden auf $\geq 80$ dB	Exposition während 8 Stunden auf $> 70$ dB und $\geq 80$ dB
Gehörschützer sind obligatorisch	Gehörschützer werden zur Verfügung gestellt für Arbeiter	Gehörschützer werden empfohlen



Gehörschützer sind die einfachste und schnellste Weise zum Schutz des Hörapparats vor den Folgen von Lärm.

**Gehörschützer werden folgenderweise unterteilt:**



**⊙ KAPSELGEHÖRSCHÜTZER**

Kapselgehörschützer setzen sich aus zwei lärmdämpfenden Kapseln zusammen, die die Ohrmuscheln umschließen und mit den weichen Dichtungskissen, die normalerweise mit Schaumstoff aus Kunststoff oder einer Flüssigkeit gefüllt sind, an den Kopf anliegen. Die Kapseln sind normalerweise mit einem Material ausgefüllt, das lärmdämpfende Eigenschaften hat. Kapselgehörschützer können einzeln oder an Schutzhelme montiert getragen werden.

**⊙ GEHÖRSCHUTZSTÖPSEL**

Gehörschutzstöpsel (Lärmschutzstöpsel) - dies sind Gehörschützer die innen im Gehörgang getragen werden. Sie dienen dem dichten Abschießen des Gehörgangs. Gehörschutzstöpsel werden in Einweg- und Mehrweg-Gehörschutzstöpsel unterteilt. Sie können durch den Hersteller geformt werden (z. B. aus Silikon) oder durch den Nutzer (z. B. aus Schaumstoff). Es gibt ebenfalls Gehörschutzstöpsel mit einem Bügel, wobei der Bügel bei diesen die Funktion einer Andrückfeder hat und die Ohrstöpsel im Innenohr oder am Eingang des Gehörganges halten soll. Der Bügel kann auf dem Kopf, unter dem Kinn oder am Hinterkopf getragen werden. Die Größe der Gehörschutzstöpsel muss für jeden Nutzer sorgfältig ausgewählt werden, da falsch ausgewählte Gehörschutzstöpsel ein Druckgefühl verursachen und den Gehörgang reizen können.

**DÄMMWERT**

**SNR**

(Vereinfachte Rauschunterdrückung) Gemittelter Dämmwert.

**HML**

Schalldämmung in Bezug auf den gemittelten Frequenzbereich.

**H:** Dämmung hoher Frequenzen (hohe Töne)

**M:** Dämmung mittlerer Frequenzen

**L:** Dämmung niedriger Frequenzen (niedrige Töne)



**KENNZEICHNUNG DER GEHÖRSCHUTZSTÖPSEL**

Aufgrund der Charakteristik des Produkts sollte sich die Kennzeichnung auf der Verpackung oder dem Spender befinden.

- Nutzungs- und Einsetzanweisung
- Größe
- Norm-Nr.
- CE-Zeichen

**KENNZEICHNUNG VON KAPSELGEHÖRSCHÜTZERN**

- Identifikationszeichen des Herstellers
- CE-Zeichen
- Nummer der Norm
- Kennzeichnung vorne/hinten, oben/unten, falls die Lage der Dämmkissen relevant ist.



# ATEMSCHUTZ

## KENNZEICHNUNG DER HALBMASKEN



- CE-Zeichen und Kennzeichen der benannten Stelle
- positives Testergebnis für die Prüfung auf Verstopfung durch Dolomitstaub
- Kennzeichnung des Nutzungsfaktors (NR - einmaliger Gebrauch; R - wiederverwendbar)
- Individuelle Produktnummer
- Nummer der Norm
- Produktionsdatum
- Kennzeichnung des Modells
- Schutzklasse
- Name des Herstellers

Filterhalbmasken werden nach deren Filtereigenschaften in drei Klassen unterteilt: **FFP1, FFP2, FFP3**.

Tabelle des Filtrationsgrades für jede der Klassen

	FFP1	FFP2	FFP3
Konzentration der Schadstoffe	bis 4xMAK	bis 10xMAK	bis 30xMAK
Filtrationsgrad	80%	94%	99%
Übergang	20%	6%	1%
Anfänglicher Einatmungswiderstand bei Durchfluss von 95l/Min.	<210 Pa	<240 Pa	<300 Pa

## VERZEICHNIS DER NORMEN

**EN149:2001** Atemschutzgeräte Filternde Halbmasken zum Schutz gegen Partikel - Anforderungen, Prüfung, Kennzeichnung. Gilt für Filterhalbmasken der Schutzkategorie III. Beschreibt die minimalen Anforderungen für die Prüfung und Kennzeichnung von Filterhalbmasken, die als Schutzausrüstung für den Schutz der Atemwege vor Teilchen eingesetzt werden, jedoch unter Ausnahme der Masken, die im Fluchfall verwendet werden.

**MAK** – Maximale Konzentration der toxischen, chemischen Verbindung oder der Konzentration eines anderen Gefahrenstoffes, die während 8-Tagesstunden und der durchschnittlichen Wochenarbeitszeit auf den Arbeiter einwirken darf und im Arbeitsgesetzbuch festgelegt wird und der im Zeitraum der beruflichen Tätigkeit keine negativen Auswirkungen auf die Gesundheit haben sollte.

## DIE ANWENDUNG VON ATEMSCHUTZGERÄTEN WÄHREND DER ARBEIT IST IN FOLGENDEN FÄLLEN ERFORDERLICH:

- Konzentration der gefährlichen Substanzen in der Luft überschreitet die Maximale Arbeitsplatzkonzentration (**MAK**) für diese Substanzen
- Sauerstoffgehalt der eingeatmeten Luft liegt unter 17%
- Temperatur der eingeatmeten Luft ist nicht konform mit der durch die Norm zulässigen Temperatur, in der eine Person arbeiten kann

# HANDSCHUTZ

Ein ausgesprochen wichtiger Teil der persönlichen Schutzausrüstung sind die Schutzhandschuhe, die die Hände vor unerwünschten und/oder für die Gesundheit und das Leben schädlichen Faktoren schützen. Korrekt ausgewählte Schutzhandschuhe schützen nicht nur die Hände entsprechend, sondern stellen den maximalen Tragekomfort sicher und haben einen positiven Einfluss auf die Sicherheit und Qualität der ausgeführten Arbeit.





## KRITERIEN FÜR DIE KORREKTE AUSWAHL VON SCHUTZHANDSCHUHEN

### Größe

Die unten aufgeführte Tabelle gibt die Leitlinien der Norm **EN 420** für die einzelnen Handschuhgrößen an, die den entsprechenden Handabmessungen zugeordnet sind. Die Schutzhandschuhe der Marke Lahti Pro stellen dem Nutzer eine optimale Anpassung an die Hand sicher und garantieren die Sicherheit sowie einen hohen Tragekomfort des Nutzers.

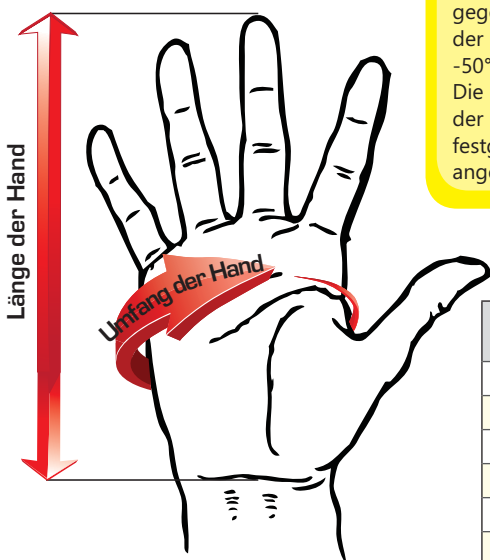

## VERZEICHNIS DER NORMEN

### EN 420

- **Schutzhandschuhe** - Allgemeine Anforderungen und Prüfverfahren. Gilt für alle Schutzhandschuhe, unabhängig der Schutzkategorie, der die Schutzhandschuhe zugeordnet sind (betrifft also die Schutzkategorie I, II und III). In der Norm werden die allgemeinen Anforderungen und die entsprechenden Prüfverfahren festgelegt, die für den Entwurf und die Konstruktion der Handschuhe gelten sowie für die Wasserdurchlässigkeit des Handschuhmaterials, die Unschädlichkeit, den Komfort und die Effizienz sowie die Kennzeichnung und die durch den Hersteller angegebenen Informationen, wobei diese für alle Schutzhandschuhe anwendbar sind.

### EN 388 - Schutzhandschuhe gegen mechanische Risiken.

Gilt für Schutzhandschuhe der Schutzkategorie II. Enthalten sind die Anforderungen, Prüfmethoden, Kennzeichnungen und für den Nutzer angegebene Informationen. Die Prüfungen der Handschuhe umfassen: Beständigkeit gegen mechanische Gefährdungen, wie Abrieb-, Schnitt-, Riss- und Durchstichfestigkeit. Die Parameter der mechanischen Beständigkeit der Handschuhe werden mittels vier Ziffern festgelegt, die unten auf dem Piktogramm angegeben sind.

### EN 407 - Schutzhandschuhe gegen thermische Risiken (Hitze und/oder Feuer).

Gilt für Schutzhandschuhe der Schutzkategorie II. In der Norm sind die allgemeinen Anforderungen, Prüfmethoden, Effizienzstufen für die thermische Beständigkeit, Kennzeichnungen und für den Nutzer angegebene Informationen festgelegt. Die Prüfung der Schutzhandschuhe umfasst die Beständigkeit gegen thermische Risiken, wie: Feuer, Hitze, usw. Die Parameter der thermischen Beständigkeit der Handschuhe werden mittels sechs Ziffern festgelegt, die unten auf dem Piktogramm angegeben sind.

### EN 511 - Schutzhandschuhe gegen Kälte.

Gilt für Schutzhandschuhe der Schutzkategorie II. In der Norm sind die Anforderungen für die Kennzeichnung, die für den Nutzer angegebenen Informationen und die Prüfung der vor Konvektion und Kälteleitfähigkeit bis -50°C schützenden Handschuhe angegeben. Die Parameter der thermischen Beständigkeit der Handschuhe werden mittels drei Ziffern festgelegt, die unten auf dem Piktogramm angegeben sind.

Größe des Handschuhs	Länge der Hand	Umfang der Hand
6 [XS]	16.0 cm	bis 15.2 cm
7 [S]	17.1 cm	bis 17.8 cm
8 [M]	18.2 cm	bis 20.3 cm
9 [L]	19.2 cm	bis 22.9 cm
10 [XL]	20.4 cm	bis 25.4 cm
11 [2XL]	21.5 cm	bis 27.9 cm

**EN ISO 10819 - Mechanische Schwingungen und Stöße.** - Hand-Arm-Schwingungen - Messung und Bewertung der Schwingungsübertragung von Handschuhen in der Handfläche. Gilt für Schutzhandschuhe der Schutzkategorie II. In der Norm sind die Anforderungen für die Kennzeichnung und die für den Nutzer angegebenen Informationen angegeben und die Methode für die Laborprüfung wird festgelegt sowie die Art der Datenanalyse und die Art der Erstellung des Prüfprotokolls für den Koeffizienten der Schwingungsübertragung für die Schutzhandschuhe mit schwingungsdämpfendem Material, das die Handfläche und die Finger der Hand samt dem Daumen umfasst. Entsprechend der festgelegten Prüfprozedur für Handschuhe, die für den Schutz vor Schwingungen angeboten werden, werden zwei charakteristische Koeffizienten der Handschuhe bemessen:

- Korrigierte Schwingungsübertragung TRM für das Prüfsignal M (Frequenzspektrum 32-200 Hz)
- Korrigierte Schwingungsübertragung TRH für das Prüfsignal H (Frequenzspektrum 200 - 250 Hz)

### EN 12477 - Schutzhandschuhe für Schweißer.

Gilt für Schutzhandschuhe der Schutzkategorie II. In der Norm sind die Anforderungen angegeben zur Kennzeichnung, zu den durch den Hersteller angegebenen Informationen und den Prüfungen der Schweißerschutzhandschuhe, die für das Handschweißen von Metallen, das Schneiden und verwandte Verfahren verwendet werden. In Übereinstimmung mit der oben genannten Norm werden Schweißerschutzhandschuhe in die folgenden Gruppen unterteilt:

- Ausführung A (stellen die Einhaltung der Anforderungen im Bereich der Schutzigenschaften auf einer höheren Stufe sicher)
- Ausführung B (werden für Arbeiten eingesetzt, die eine hohe Fingerwertigkeit erfordern, z. B. TIG-Schweißen).

### EN381-7 - Anforderungen an Schutzhandschuhe für Kettensägen.

In der Norm werden die Anforderungen für Schutzhandschuhe, die für den Schutz von Benutzer von handgeführten Kettensägen verwendet werden, festgelegt. Es werden zwei Muster für Schutzhandschuhe für Kettensägen definiert - Muster A und Muster B. Es werden Anforderungen bezüglich der Beständigkeit gegen den Durchschnitt mit einer Kettensäge bestimmt sowie Anforderungen für die Beständigkeit auf mechanische Faktoren, die Ergonomie und die Kennzeichnung, die Informationen des Herstellers und die Nutzungsanweisungen. Es wurden ebenfalls Ratschläge zur Auswahl des entsprechenden Schutzhandschuhmusters angegeben. Die Handschuhe werden entsprechend dem Schutz vor dem Durchschnitt einer Kettensäge in vier Klassen unterteilt, wobei dies je nach Geschwindigkeit der Kettensäge erfolgt: Klasse 0 - 16 m/s, Klasse 1- 20 m/s, Klasse 2- 24 m/s, Klasse 3- 28 m/s.

PROLINE

LAHTI PRO

MEGA

JUCO

OTHER BRANDS

ERDI

KLINGSPOR

EXPRESS

ACTION CAN

TRYTON

VULCAN

EN388



abcdef

Parameter	Klasse 1	Klasse 2	Klasse 3	Klasse 4	Klasse 5	
(a) Abriebfestigkeit (Anzahl der Umdrehungen)	100	500	2000	8000	-	
(b) Schnittfestigkeit (Faktor)	1.2	2.5	5.0	10.0	20.0	
(c) Rißfestigkeit [N]	10	25	50	75	-	
(d) Durchstichfestigkeit [N]	20	60	100	150	-	
Parameter	Klasse A	Klasse B	Klasse C	Klasse D	Klasse E	Klasse F
(e) Schnittfestigkeit gemäß ISO 13977 [N]	2	5	10	15	22	30
Parameter	Klasse P					
(f) Stoßfestigkeit gemäß EN 13594:2015	JA					

Parameter a-d gemäß EN 388:2002; Parameter a-f gemäß EN 388:2016

EN407



abcdef

Parameter	Klasse 1	Klasse 2	Klasse 3	Klasse 4
(a) Brennverhalten				
Nachbrennzeit [s]	≤ 20	≤ 10	≤ 3	≤ 2
Nachglühzeit [s]	Keine Anforderungen	≤ 120	≤ 25	≤ 5
(b) Beständigkeit gegen Kontaktwärme				
Kontakttemperatur Tc [°C]	100	250	350	500
Schwellenzeit tt [s]	≥ 15	≥ 15	≥ 15	≥ 15
(c) Schutz vor Konvektionswärme				
Wärmeübergangsindex HTI [s]	≥ 4	≥ 7	≥ 10	≥ 18
(d) Schutz vor Strahlungswärme	20	60	100	150
Wärmeübertragung t24 [s]	≥ 7	≥ 20	≥ 50	≥ 95
(e) Schutz vor kleinen Spritzern von geschmolzenem Metall				
Anzahl der Tropfen	≥ 10	≥ 15	≥ 25	≥ 35
(f) Schutz vor großen Mengen				

EN12477

Eigenschaften	Anforderungen	
	Typ A	Typ B
Abriebfestigkeit - Leistungsstufe (Anzahl der Zyklen)	2 (500)	1 (100)
Schnittfestigkeit - Leistungsstufe (Faktor I)	1 (1.2)	1 (1.2)
Weiterreißfestigkeit - Leistungsstufe (Wert in N)	2 (25)	1 (10)
Durchstichfestigkeit - Leistungsstufe (Wert in N)	2 (60)	1 (20)
Brennverhalten - Leistungsstufe	3 (Dauer des Nachbrennens ≤ 3 s, Dauer des Nachglühens ≤ 25 s)	2 (Dauer des Nachbrennens ≤ 3 s, Dauer des Nachglühens ≤ 25 s)
Schutz vor Kontaktwärme - Leistungsstufe (Kontakttemp. in °C)	1 (100)	1 (100)
Schutz vor kleinen Spritzern von geschmolzenem Metall - Leistungsstufe (Anzahl der Tropfen)	2 (≥7)	Keine Anforderungen
Fingerfertigkeit - Leistungsstufe (Drahtdurchmesser in mm)	1 (11)	4 (6.5)

EN511



abc

Parameter	Klasse 1	Klasse 2	Klasse 3	Klasse 4
a) Wärmeisolierung				
Wärmeisolierung ITR [m2K/W]	0.10 ≤ ITR < 0.15	0.15 ≤ ITR < 0.22	0.22 ≤ ITR < 0.30	0.30 ≤ ITR
(b) Thermischer Widerstand				
Thermischer Widerstand R [m2K/W]	0.025 ≤ R < 0.050	0.050 ≤ R < 0.100	0.100 ≤ R < 0.150	0.150 ≤ R

C - Parameter – Wasserundurchlässigkeit – 0 oder 1



Material der Beschichtung / Grifffläche des Handschuhs

„WERKSTATT“-HANDSCHUHE AUS KUNSTLEDER

Kunstleder ist ein Material, das sich durch Beständigkeit und Abnutzungsfestigkeit auszeichnet. Handschuhe aus Kunstleder verfügen meistens über zahlreiche Verstärkungen und/oder Polster, die vor Blasen und Vibrationen schützen – außerdem verfügen sie über ein Bündchen mit Klettverschluss. Die hohe Lebensdauer, der Tragekomfort, sowie die Tatsache, dass der gehaltene Gegenstand hervorragend gefühlt werden kann, führen dazu, dass diese Handschuhe oftmals in Autowerkstätten verwendet werden. Deshalb werden sie umgangssprachlich auch als Werkstatthandschuhe bezeichnet. Aber sie erfreuen sich unter anderem auch in der Transportbranche, bei Lagerarbeiten und bei allen Freizeitbeschäftigungen großer Beliebtheit.

HANDSCHUHE AUS NATURLEDER

Handschuhe aus Naturleder zeichnen sich durch eine hohe Abrieb- und Rissbeständigkeit aus. Sie zeichnen sich darüber hinaus durch eine gute Atmungsaktivität aus. Sie stellen den höchsten Nutzungskomfort sowie eine gute Griffigkeit sicher, wodurch sie selbst die anspruchsvollsten Nutzer zufrieden stellen. Dank ihrer vielen Nutzungseigenschaften werden Handschuhe aus Naturleder in vielen Branchen verwendet, wie z. B. im Bauwesen, Transport, in der Autoindustrie und in der Landwirtschaft.

HANDSCHUHE MIT LATEXBESCHICHTUNG

Latex ist das am häufigsten für Beschichtungen von Schutzhandschuhen verwendete Material. Handschuhe mit Latexbeschichtung oder Handschuhe aus Latex zeichnen sich durch ihre hohe Elastizität aus und das auch bei niedrigen Temperaturen. Außerdem sind sie sehr reißfest und liefern auch unter den schwierigsten Wetterbedingungen eine hervorragende Leistung. Die große Vielseitigkeit von Latex und die verhältnismäßig geringen Produktionskosten bedeuten, dass Latexhandschuhe unter anderem im Bauwesen, im Lagerwesen, in der Transportindustrie, in der Landwirtschaft, im Haushalt und im Garten verwendet werden.

GEFÜTTERTE HANDSCHUHE

Gefütterte Handschuhe sind für Arbeiten unter schwierigen Wetterbedingungen, einschließlich niedriger Temperaturen, vorgesehen. Durch ihre Beschichtung sind sie vielseitig einsetzbar. Die synthetische Faser, die kein Wasser absorbiert und die Körperwärme konstant hält, schützt den Nutzer vor Kälte, Regen, Schnee und Wind. Gefütterte Handschuhe finden unter anderem auf dem Bau, in der Transportbranche und in Kühllhäusern Anwendung.

**HANDSCHUHE MIT NITRILBESCHICHTUNG**

Das Nitril, aus dem die Handschuhe der Marke Lahti Pro hergestellt werden, stellt ein synthetisches Gummigemisch dar, das sich aus Acrylnitril und Butadien zusammensetzt und keine Latexweiße enthält. Die Zusammensetzung dieser zwei Substanzen ergibt ein elastisches Material mit hoher Abriebfestigkeit, das gleichzeitig eine hervorragende Beständigkeit gegen bleifreies Benzin, Diesel, Hexan und Paraffin sicherstellt. Es bietet ebenfalls einen hervorragenden Schutz vor Ölen und Schmiermitteln. Handschuhe mit Nitrilbeschichtung werden oftmals in der Transportbranche und in der Autoindustrie verwendet sowie in der Landwirtschaft und in Gärten. Sie stellen ebenfalls eine hervorragende Alternative für Personen mit einer Latexallergie dar.

**HANDSCHUHE MIT POLYURETHANBESCHICHTUNG (PU)**

Polyurethan ist ein Material mit sehr hoher Elastizität und hoher Abrieb- und Rissbeständigkeit. Dank diesen Eigenschaften ist es hervorragend für die Herstellung von Handschuhen mit einer dünnen und gleichzeitig sehr beständigen Beschichtung geeignet. Polyurethanhandschuhe stellen dem Nutzer eine gute Fingerfertigkeit sicher sowie das hervorragende Vermögen, den gehaltenen Gegenstand zu fühlen, sie eignen sich unter anderem hervorragend für Arbeiten, die eine große Präzision erfordern. Diese Handschuhe werden z. B. häufig von Mechanikern, Lagerarbeitern und im Haushalt verwendet.

**HANDSCHUHE MIT PVC-BESCHICHTUNG**

Handschuhe mit PVC-Beschichtung zeichnen sich durch ihre hervorragende Beständigkeit u.a. gegen Schmiermittel, Öle, Fette, milde Reinigungsmittel und Wasser aus. Für niedrige Temperaturen sind sie ebenfalls ziemlich gut geeignet. Sie finden in vielen verschiedenen Branchen, wie z. B. der Automobilindustrie, der Landwirtschaft und dem Sportwesen, Anwendung.



**Eigenschaften der Materialien der Beschichtung/ Grifffläche des Handschuhs**

Eigenschaften der Beschichtung	Art der Beschichtung/ Grifffläche des Handschuhs					
	Kunstleder*	Leder natürlich	Latex	Nitril	Polyurethan (PU)	PVC
Dehnbarkeit	1	1	5	4	5	3
Rutschfestigkeit	1	2	4	5	3	5
Griffigkeit (Tastgefühl des gehaltenen Gegenstandes)	5	4	3	4	5	3
Abriebfestigkeit	5	5	2	5	5	4
Rißfestigkeit	5	5	5	1	5	1
Durchstichfestigkeit	5	5	2	5	2	3
Beständigkeit gegen Wasser und verwandte Substanzen	1	2	5	3	3	5
Beständigkeit gegen Fette und Öle	2	3	2	5	4	5
Beständigkeit gegen Kohlenwasserstoffe	1	1	1	4	1	2
Beständigkeit gegen Wasch- und Reinigungsmittel	1	1	5	4	4	5
Beständigkeit gegen ketonische Lösungsmittel	1	1	4	1	2	1

1 Sehr niedrig   
 2 Niedrig   
 3 Mittelmäßig   
 4 Hoch   
 5 Sehr hoch

\*Die Griffflächen von vielen aus Kunstleder hergestellten Modellen der Lahti Pro Handschuhe sind mit zahlreichen Verstärkungen aus PVC, Anti-Rutsch-Silikonnetzen usw. ausgestattet, die die Eigenschaften der Handschuhe deutlich verbessern.

Die Informationen in der oben aufgeführten Tabelle beziehen sich ausschließlich auf Kunstleder – die Eigenschaften der ergänzenden Materialien wurden daher nicht berücksichtigt.

**Achtung:** Die oben aufgeführte Tabelle enthält zur Übersicht eine Zusammenstellung der Haupteigenschaften der einzelnen Arten der Beschichtungen/Griffflächen der Handschuhe. Die Eigenschaften der Beschichtung/Grifffläche können sich abhängig von dem Handschuhmodell unterscheiden.



**Gewebetyp, aus dem die Handschuhe hergestellt werden sollten**

Diese Tabelle beinhaltet die Hauptvorteile der einzelnen für die Produktion der Schutzhandschuhen verwendeten Gewebe:

Typ des Gewebes	Vorteile	
Polyester	<ul style="list-style-type: none"> <li>⊕ Kann mit Baumwolle gemischt werden, um den Tragekomfort zu erhöhen</li> <li>⊕ Stark und beständig</li> <li>⊕ Abriebfest und dehnfest</li> </ul>	<ul style="list-style-type: none"> <li>⊕ Beständig gegen Durchnässung</li> <li>⊕ Trocknet schnell</li> <li>⊕ Elastisch</li> </ul>
Baumwolle	<ul style="list-style-type: none"> <li>⊕ Sehr atmungsaktiv, luftdurchlässig, keine Hitzestauung</li> <li>⊕ Weich (hoher Tragekomfort)</li> <li>⊕ Abriebfest</li> </ul>	<ul style="list-style-type: none"> <li>⊕ Absorbiert Schweiß</li> <li>⊕ Antistatisch</li> </ul>
Nylon	<ul style="list-style-type: none"> <li>⊕ Stark und beständig</li> <li>⊕ Sehr abriebfest und dehnfest</li> <li>⊕ Beständig gegen Öle, Fette und Benzin</li> </ul>	<ul style="list-style-type: none"> <li>⊕ Beständig gegen Durchnässung</li> <li>⊕ Elastisch</li> </ul>
Acryl	<ul style="list-style-type: none"> <li>⊕ Hervorragender Schutz gegen Kälte</li> <li>⊕ Weich (hoher Tragekomfort)</li> <li>⊕ Beständig gegen Durchnässung</li> </ul>	<ul style="list-style-type: none"> <li>⊕ Abriebfest und dehnfest</li> <li>⊕ Beständig gegen Öl</li> </ul>
Modifiziertes Gewebe, synthetisch	<ul style="list-style-type: none"> <li>⊕ Sehr schnittfest</li> <li>⊕ Extrem abriebfest und dehnfest</li> </ul>	<ul style="list-style-type: none"> <li>⊕ Beständig gegen Durchnässung</li> <li>⊕ Elastisch</li> </ul>

PROLINE  
 LAHTI PRO  
 MEGA  
 JUCO  
 OTHER BRANDS  
 ERDI  
 KLINGSPOR  
 EXPRESS  
 ACTION CAN  
 TRYTON  
 VULCAN

# KÖRPERSCHUTZ

## KENNZEICHNUNG DER SCHUTZKLEIDUNG

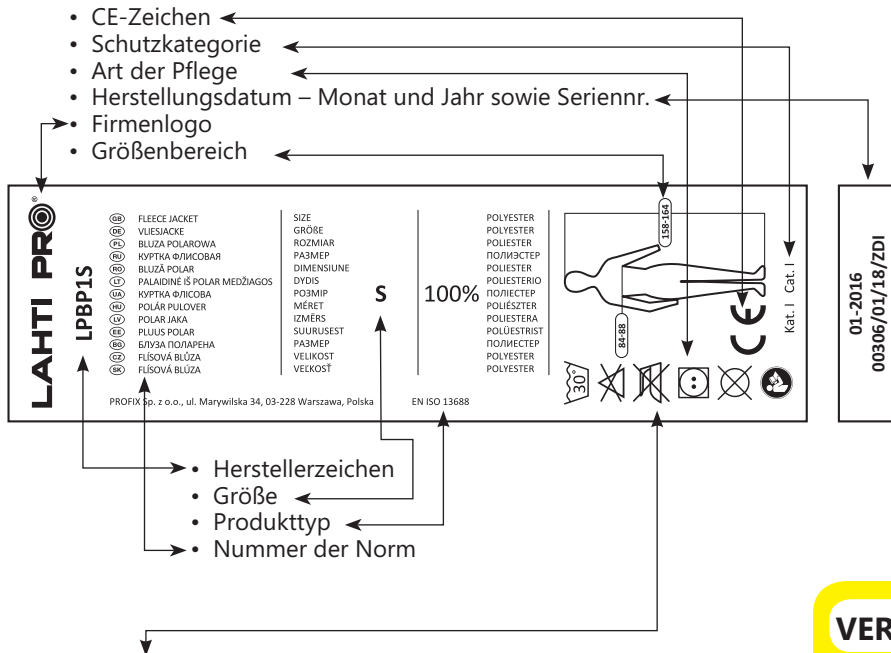

## GRÖSSE

C - Brustbreite  
W - Breite in der Taille  
H - Höhe

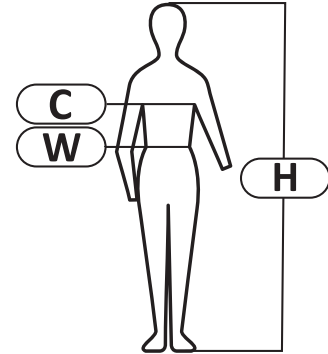

SYMBOL	BESCHREIBUNG
	Nicht waschen
	Handwäsche
	Waschen bei 30°C - normal
	Waschen bei 30°C - schonend
	Waschen bei 30°C - sehr schonend
	Nicht bügeln
	Bügeln bis 110°C
	Bügeln bis 150°C
	Bügeln bis 200°C
	Nicht im Trommelrockner trocknen
	Trommelrocknen – niedriger Temperatur
	Trommelrocknen – normale Temperatur
	Trocknen auf der Leine
	Hängend trocknen
	Tropfnass trocknen
	Nicht chemisch reinigen
	Professionelle chemische Reinigung mit Tetrachlorethen
	Bleichen mit Chlor nicht erlaubt

## VERZEICHNIS DER NORMEN

**EN ISO 13688 - Schutzkleidung** - Allgemeine Anforderungen. In dieser Internationalen Norm wurden die allgemeinen Anforderungen für die Herstellung, Ergonomie, Unschädlichkeit, Größenkennzeichnung, Alterungsprozesse, Kompatibilität und Kennzeichnung der Schutzkleidung sowie zu den durch den Hersteller mit dem Produkt zu liefernden Informationen festgelegt. Diese Internationale Norm kann nur im Zusammenhang mit anderen Normen verwendet werden, die die Anforderungen für bestimmte Ausführungsarten festlegen. Die Norm kann nicht als selbstständiges Basisdokument verwendet werden.

**EN ISO 20471 - Hochsichtbare Kleidung** - Prüfverfahren und Anforderungen. In der Norm werden die Anforderungen festgelegt für Kleidungsstücke mit hoher Sichtbarkeit, die die Möglichkeit zur visuellen Signalisierung der Anwesenheit im Verkehrsbereich des Nutzers für den Bediener von Fahrzeugen oder anderen mechanischen Geräten geben, unter allen Beleuchtungsbedingungen, sowohl im Tageslicht als auch in der Dunkelheit bei Beleuchtung durch die Fahrzeugscheinwerfer. In der Norm werden die Anforderungen für die Farbe und die Reflexeigenschaften sowie für die minimalen Flächen und die Lokalisierung der Materialien auf der Schutzkleidung klar festgelegt. Darüber hinaus geht aus der Norm die Verpflichtung hinaus, dass der Nutzer über die maximale Anzahl der Waschkzyklen und die Waschart informiert werden muss, die für die Warnkleidung mit Einhaltung der entsprechenden Schutzstufe angewendet werden darf.

### EN ISO 20471

Durch die Norm wird die Kleidung in 3 Kategorien unterteilt, wobei dies auf Grundlage der minimalen Flächen des Reflexmaterials in m<sup>2</sup> erfolgt und Kategorie 1 die niedrigste Kategorie und Kategorie 3 das höchste Sichtbarkeitsniveau darstellt.

	Kleidung Kategorie 3	Kleidung Kategorie 2	Kleidung Kategorie 1
Material Hintergrund	0.8 m <sup>2</sup>	0.5 m <sup>2</sup>	0.14 m <sup>2</sup>
Material reflektierend	0.2 m <sup>2</sup>	0.13 m <sup>2</sup>	0.10 m <sup>2</sup>
Material mit verbundenen Eigenschaften	...	...	0.2 m <sup>2</sup>

☉ **KLEIDUNG FÜR SCHWEISSER**

Schutzkleidung für Schweißer als Persönliche Schutzausrüstung der Kategorie II muss über eine EG-Baumusterprüfbescheinigung verfügen, die die Konformität mit der Richtlinie 89/686/EWG nachweist.

**BESTIMMUNG**

Schutzkleidung für Schweißer ist erforderlich für Schweißarbeiten, die folgendes umfassen: Schweißen, Auftragschweißen, Löten und thermisches Schneiden von Metallen sowie thermoplastischen Kunststoffen. Während der Schweißarbeiten sind Schweißer folgenden Gefahren ausgesetzt: Blendung, Verbrennung durch heiße Metallsplinter, während des Schweißens entstehender Rauch und Staub mit toxischen und krebserregenden Eigenschaften, elektromagnetische Felder, Ultraviolettstrahlung und thermische Strahlung, Stromschläge, Brände, Vergiftungen, Erkrankungen der Haut, Augen und Lungen.

**MATERIALANFORDERUNGEN**

Schutzkleidung für Schweißer wird hauptsächlich aus schwer brennbaren Textilien aus Baumwolle mit Brennschutzimprägnierung mit einer hohen Oberflächenmasse, sowie aus natürlichem Leder mit unbrennbarer Verarbeitung, hergestellt.

**KONSTRUKTIONSANFORDERUNGEN**

Schutzkleidung für Schweißer muss festgelegte Anforderungen bezüglich der Konstruktion erfüllen, sodass die Gefahr des Eindringens von heißen Absplatterungen unter die Kleidung reduziert wird:

- Während der Durchführung von Schweißarbeiten muss die Schutzkleidung für Schweißer den Körper des Trägers abdecken, d. h. Ober- und Unterkörper, Hals, Schultern, Arme und Beine müssen abgedeckt sein.
- Falls die Schutzkleidung sich aus einem Hemd und einer Hose zusammensetzt, muss das Hemd des zweiteiligen Kleidungssets die obere Kante der Hosen überlappen und eine Schutzfalte von mindestens 20 cm bilden. Die Mindesthöhe der Schutzfalte muss während der Ausführung aller Tätigkeiten und Bewegungen während des Arbeitsprozesses eingehalten werden.
- Kleidungsstücke, die eine zusätzliche Schutzkleidung bilden, z. B. Gesichtsschutz, Schweißermaske, Schweißärmel, Schutzschürzen und Fußschützer, Handschuhe, müssen so entworfen und genutzt werden, dass sie ein Durchdringen von Funken oder Metalltropfen in das Kleidungsinnere verhindern.
- Falls die Kleidungsstücke mit Taschen entworfen wurden, müssen die Öffnungen mit Stoffklappen gesichert werden.
- Falls Hosen mit Taschen ausgestattet sind, dann dürfen dies nur Seitentaschen sein, deren Öffnungen um nicht mehr als 10° von der Seitennaht der Hose abweichen dürfen.
- Hosen dürfen keine Manschetten haben. Die Kleidung muss auf eine solche Weise angefertigt werden, dass die Leitfähigkeit von Strom von Außen nach innen verhindert wird, z. B. durch Metallverschlüsse.

**KLASSEN**

Es werden zwei Klassen von Schutzkleidung für Schweißer mit präzise festgelegten Effektivitätsanforderungen bestimmt:

**Klasse 1:** - bietet Schutz vor weniger gefährlichen Schweißtechniken und vor Situationen, die eine geringfügige Auswirkung von Spritzern von geschmolzenen Metallen und Wärmestrahlung verursachen.

**Klasse 2:** - bietet Schutz vor gefährlicheren Schweißtechniken und vor Situationen, die eine schwerwiegende Auswirkung von heißen Faktoren verursachen.

Den oben aufgeführten Kleidungsklassen werden in Übereinstimmung mit der Norm EN ISO 11611 bestimmte Arten von angewendeten Schweißprozessen zugeschrieben sowie die Charakteristik der Tätigkeiten (Art der bedienten Maschinen), die auf dem gegebenen Arbeitsplatz ausgeführt werden, wodurch die entsprechende Auswahl der Schutzkleidung für Schweißer ermöglicht wird.

Klasse der Kleidung	Art des verwendeten Schweißprozesses	Charakteristik der auf dem gegebenen Arbeitsplatz ausgeführten Tätigkeiten
Klasse 1	Manuelle Schweißtechniken mit einer geringen Formung von Spritzern und Tropfen von geschmolzenem Metall, z. B.: • Gasschweißen, • WIG-Schweißen, • MIG-Schweißen, • Mikroplasma-schweißen, • Löten, • Punktschweißen, • MMA-Schweißen (Elektrode mit Rutil-Umhüllung).	Bedienung von Maschinen, z. B.: • Schneidemaschinen mit Verwendung von Sauerstoff, • Schneidemaschinen mit Verwendung von Plasma, • Widerstandsschweißgeräte, • Maschinen für Wärmearbeiten, • Werkstattsschweißgeräte.
Klasse 2	Manuelle Schweißtechniken mit einer hohen Anzahl von Spritzern und Tropfen, z. B.: • MMA-Schweißen (Elektrode mit normaler oder Cellulose-Umhüllung), • MAG-Schweißen (Umhüllung aus CO <sub>2</sub> oder Gasgemisch), • MIG-Schweißen (mit hoher Stromstärke), • Schweißen mit selbstumhüllenden Drahtelektroden (Pulverelektroden), • Plasmaschneiden, • Hobeln, • Sauerstoffschneiden, • Wärmearbeiten.	Bedienung von Maschinen, z. B.: • in beengten Räumen, • beim Schweißen/Schneiden in einer Überkopffosition oder in vergleichbaren, erzwungenen Positionen.



## VERZEICHNIS DER NORMEN

EN ISO 11611



**EN ISO 11611 Schutzkleidung für Schweißen und verwandte Verfahren.** In der Norm werden die grundlegenden Mindestanforderungen festgelegt sowie Prüfmethode für die Schutzkleidung für Schweißer und Arbeiter, die verwandte Tätigkeiten mit vergleichbarem Risiko ausführen. Diese Art von Kleidung ist bestimmt für den Schutz des Trägers vor den Einwirkungen von geschmolzenem Metall, Funken, die während des Schleifens von Metall entstehen, vor dem kurzzeitigen Kontakt mit Flammen und Wärmestrahlung von Lichtbögen. Die Kleidung minimalisiert ebenfalls die Möglichkeit des Auftretens eines Schocks bei einem kurzzeitigen, zufälligen Kontakt mit einer Stromleitung unter einer Spannung von bis zu 100V unter normalen Bedingungen und während des Schweißens. Verfahren A1 – Prüfverfahren für horizontale Beflammung Verfahren A2 – Prüfverfahren für Randbeflammung A1 + A2 erfüllt - begrenzte Ausbreitung von Flammen

EN ISO 11612



**EN ISO 11612 Schutzkleidung - Kleidung zum Schutz gegen Hitze und Flammen - Mindestleistungsanforderungen.** Die Norm definiert die Anforderungen für Kleidung, die ausgelegt ist für den Schutz des Körpers des Trägers, unter Ausschluss der Hände, vor Hitze und Flammen. In der Norm werden die Anforderungen für eine breite Schutzkleidungsgruppe aufgeführt, die sich durch Entzündungsbeständigkeit bei kurzzeitigem Flammenkontakt auszeichnen muss und die Ausbreitung von Flammen verhindern muss (A1 + A2) und den Träger vor mindestens einer Art von Hitzefaktor schützen muss. Schutzniveau für den Schutz vor Hitze (je höher die Zahl, desto höher das Schutzniveau):

- Konvektionshitze (B1, B2, B3)
- Wärmestrahlung (C1, C2, C3, C4)
- Spritzer von geschmolzenem Aluminium (D1, D2, D3)
- Spritzer von geschmolzenem Eisen (E1, E2, E3)
- Kontaktwärme (F1, F2, F3).

## Ⓢ SCHUTZKLEIDUNG MIT ANTISTATISCHEN EIGENSCHAFTEN

Schutzkleidung mit antistatischen Eigenschaften als Persönliche Schutzausrüstung der Kategorie II muss über eine EG-Baumusterprüfbescheinigung verfügen, die die Konformität mit der Richtlinie 89/686/EWG nachweist.

### BESTIMMUNG

Schutzkleidung mit antistatischen Eigenschaften ist in explosionsgefährdeten Bereichen (z. B. Chemieindustrie, Bergbauindustrie, Erdölindustrie, Transport von Gefahrenstoffen, Kraftwerke usw.) erforderlich sowie außerhalb von Gefahrenbereichen (z. B. bei der Produktion von Elektronenbauelementen zum Schutz vor Beschädigungen durch elektrostatische Entladungen).

### MATERIALANFORDERUNGEN

Schutzkleidung mit antistatischen Eigenschaften wird aus Textilien hergestellt, die sich durch ihre Eigenschaft zur Zerstreung und Ableitung von elektrostatischen Ladungen auszeichnen, wodurch eine elektrostatische Entladung verhindert wird, die ein Entzündungspotenzial hat.

### KONSTRUKTIONSANFORDERUNGEN

Schutzkleidung mit antistatischen Eigenschaften muss festgelegte Konstruktionsanforderungen erfüllen, sodass elektrostatische Entladungen verhindert werden:

- Die Schutzkleidung muss den gesamten Körper während der Nutzung abdecken, auch während sich der Träger bewegt oder nach vorne beugt.
- Die Schutzkleidung muss eine entsprechende Passform haben und die Bewegungsfreiheit in Situationen sicherstellen, in denen sie während der Nutzung stets geschlossen sein muss.
- Falls die Schutzkleidung aus mehreren Materiallagen besteht, muss das antistatische Material die Außenschicht der Schutzkleidung bilden.
- Verschlüsse aus Strom leitenden Materialien, z. B. Reißverschlüsse, Knöpfe, Druckknöpfe, können unter der Voraussetzung verwendet werden, dass diese mit einem antistatischen Material bedeckt sind.
- Im Fall von Materialien, die Strom leitende Garne in Form von parallelen Fäden oder Netzen enthalten, darf der Abstand zwischen den Strom leitenden Garnen in einer Richtung 10 mm nicht unterschreiten.

## VERZEICHNIS DER NORMEN

EN 1149-5



**EN 1149-5 Schutzkleidung - Elektrostatische Eigenschaften - Teil 5: Material- und Entwurfsanforderungen.**

In der Norm werden die Prüfmethode für die elektrostatischen Materialeigenschaften festgelegt sowie die Anforderungen zum Entwurf von Schutzkleidung mit antistatischen Eigenschaften, die als Element von einheitlichen Erdungssystemen zur Vorbeugung von Entladungen mit Entzündungspotenzial verwendet werden. Diese Anforderungen können sich in Bezug auf brennbare und mit Sauerstoff angereicherte Atmosphären als nicht ausreichend erweisen. Schutzkleidung mit elektrostatischen Eigenschaften wird ebenfalls als Schutzkleidung mit antistatischen Eigenschaften bezeichnet.

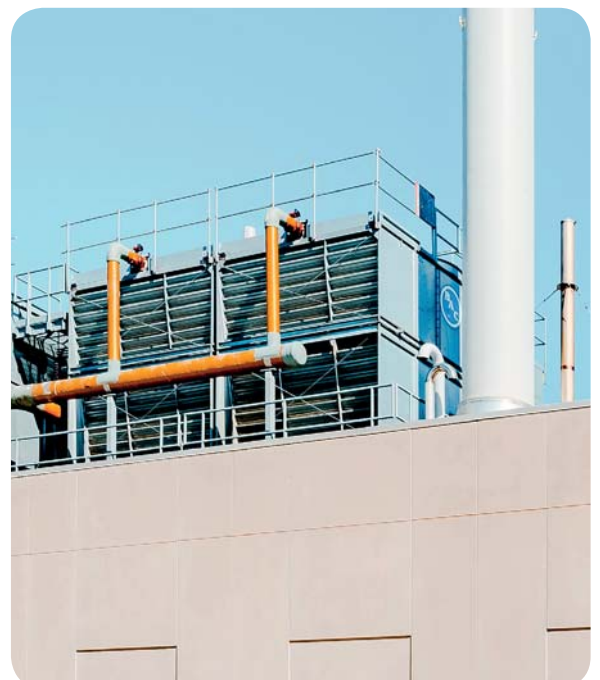

PROLINE

LAHTI PRO

MEGA

JUCO

OTHER BRANDS

ERDI

KLINGSPOR

EXPRESS

ACTION CAN

TRYTON

VULCAN

# SCHUTZ GEGEN ABSTURZ

Zu den Höhenarbeiten zählen unter anderem Arbeiten auf Gerüsten, Baukonstruktionen, Dächern, Kaminen, Leitern und anderen Erhöhungen, die sich mindestens 1,0 m über dem Gelände oder der Bodenebene befinden.

Keine Höhenarbeiten sind wiederum Arbeiten, die unabhängig von deren Höhe auf der sich der Arbeiter befindet auf Flächen durchgeführt werden, die von allen Seiten auf eine Höhe von mindestens 1,5 m mit Vollwänden (einschließlich Fenstern) abgeschirmt werden oder mit einer anderen Festkonstruktion oder einer Vorrichtung ausgestattet sind, die den Arbeiter vor einem Fall schützt.

Die polnischen und europäischen Rechtsvorschriften zur Arbeitssicherheit und Arbeitshygiene verpflichten Arbeitgeber, die Arbeiter für Höhenarbeiten einstellen, die entsprechenden Schutzvorrichtungen sicherzustellen, die die Arbeiter vor einem Fall schützen.

Stürze aus der Höhe stellen eine häufige Unfallursache dar, die im Allgemeinen schwere oder tödliche Folgen hat. Höhenarbeiten gehören zu den besonders gefährlichen Arbeiten, die eine Gefährdung für das Leben und die Gesundheit des Arbeitnehmers darstellen, daher werden die persönlichen Schutzausrüstungen, die zu dieser Gruppe gehören, zur Kategorie III eingestuft. Während der Ausführung der Höhenarbeiten müssen besondere Vorichtsmaßnahmen

aufgrund der großen Gefährdung für das Leben und die Gesundheit des Arbeitnehmers eingehalten werden. Arbeitnehmer, die zu Höhenarbeiten zugelassen werden, müssen:

- über das Berufsrisiko der ausgeführten Arbeiten belehrt worden sein;
- durch persönliche Schutzausrüstung die Möglichkeit zur Ausführung ihrer Arbeit haben;
- über ein aktuelles Tauglichkeitszeugnis für die Zulassung zur Ausführung von Höhenarbeiten verfügen;
- eine Arbeitsschutzschulung sowie eine Arbeitsplatzschulung absolviert haben, in der sie mit der Spezifität von Höhenarbeiten und den auf dem Arbeitsplatz aufkommenden Gefährdungen belehrt worden sind.

In Übereinstimmung mit der harmonisierten Norm PN-EN 365 „Persönliche Schutzausrüstung zum Schutz gegen Absturz - Allgemeine Anforderungen an Gebrauchsanleitungen, Wartung, regelmäßige Überprüfung, Instandsetzung, Kennzeichnung und Verpackung“ muss eine regelmäßige Überprüfung der Ausrüstung je ein Mal pro Jahr ab dem Zeitpunkt des Nutzungsbeginns durchgeführt werden.

Um die Anforderungen der Vorschriften zu erfüllen, muss sich jeder Arbeitssatz für Höhenarbeiten aus folgendem zusammensetzen:



**Sicherheitsgurt (EN361)** - die Hauptaufgabe des Sicherheitsgurts ist das Halten des Körpers im Falle eines Absturzes sowie die Verteilung der dynamischen Kräfte, die beim Aufhalten des Absturzes entstehen. Nur volle Auffanggurte, die über Hüft- und Schenkelgurte verfügen, sind für die Nutzung zum Schutz gegen Abstürze zugelassen.



**Ankerpunkt (EN362)** - stellt das erste und essentielle Element von der persönlichen Schutzausrüstung zum Schutz gegen Absturz dar. Seine Aufgabe ist die Befestigung des Falldämpfers an die Tragekonstruktion.



**Falldämpfer (EN355)** - Verbindet die Verbindungsklammer des Sicherheitsgurts mit dem Ankerpunkt. Im Falle eines Sturzes muss der Falldämpfer den Absturz auffangen und die Kräfte reduzieren, die bei der Abbremsung des Falls entstehen. Die Funktion des Falldämpfers kann durch folgende Vorrichtungen erfüllt werden: Falldämpfer mit Sicherheitsleine, selbstbremsende Vorrichtungen, selbstschließende Vorrichtungen und andere.

**VERZEICHNIS DER NORMEN**

**(EN362)**  
In der Norm werden die Anforderungen und Prüfmethode für Ankervorrichtungen für einen oder mehrere Nutzer beschrieben. In der Norm werden darüber hinaus die Anforderungen für die Kennzeichnung, die Gebrauchsanweisung und die Hinweise zur Montage aufgeführt.

**(EN355)**  
In der Norm werden die Anforderungen, Prüfmethode, Kennzeichnungsrichtlinien, die Informationen, deren Übergabe an den Nutzer erforderlich ist, sowie die Verpackungsart der Falldämpfer angegeben.

**(EN361)**  
In der Norm werden die Anforderungen, Prüfmethode, Kennzeichnungsrichtlinien, die von den Hersteller erforderlichen Informationen sowie die Verpackungsart der Sicherheitsgurte angegeben.



# BEINSCHUTZ



Die Sicherstellung des entsprechenden Schutzes für die Beine und Füße hat vor allem einen entscheidenden Einfluss auf die Sicherheit während der Arbeit, aber auch auf den Nutzungskomfort. Schuhe mit Schutzeigenschaften sind bestimmt für den Schutz der Füße des Nutzers vor Verletzungen, zu denen es bei Unfällen kommen könnte. Das Schuhwerk kann die Füße vor mechanischen und chemischen Faktoren sowie vor schädlichen Hitze-, Kälte- oder Feuchtigkeitseinwirkungen schützen. Die Schuhe schützen den Nutzer zumeist vor mehreren Gefährdungen gleichzeitig. Die Schutzstufe ist hauptsächlich von der Konstruktion des Schuhwerks abhängig sowie von den verwendeten Materialien und der Ausstattung der Schuhe mit Elementen wie Zehenschutzklappen, durchtrittssichere Einlagen, Fußknöchelschutz usw. Schuhe, die über keine Schutzeigenschaften verfügen und lediglich aufgrund ihrer hygienischen Vorteile am Arbeitsplatz getragen werden, können nicht als persönliche Schutzausrüstung angesehen werden und dürfen nur als Arbeitsschuhe verwendet werden.

## SCHUHAUFBAU



## VERZEICHNIS DER NORMEN

**EN ISO 20345 - Persönliche Schutzausrüstung - Sicherheitsschuhe.** In der Norm werden die allgemeinen und zusätzlichen (optionalen) Anforderungen für Sicherheitsschuhe für den allgemeinen Gebrauch angegeben. Es wurden beispielsweise das mechanische Risiko, die Rutschbeständigkeit, die thermischen Gefährdungen und ergonomischen Eigenschaften berücksichtigt. Sicherheitsschuhe (SB, S1 - 4) - verfügen über Schutzeigenschaften, einschließlich von Zehenschutzklappen, deren Beständigkeit durch einen Schlag mit einer Energie von 200 J geprüft wird.

**EN ISO 20347 - Persönliche Schutzausrüstung - Berufsschuhe.** In der Norm werden die allgemeinen und zusätzlichen Anforderungen für Berufsschuhe festgelegt. Auf die speziellen Gefährdungen wird hingewiesen in den Ergänzungen zur Norm für Schuhe für Spezialarbeiten (z. B. Schuhe für Feuerwehrmänner oder elektroisierende Schuhe) eingegangen. Berufsschuhe (OB, O1 - 5) - verfügt über Schutzeigenschaften, die vor Verletzungen schützen, die bei Unfällen am Arbeitsplatz aufkommen können. Für die tägliche Nutzung an Orten bestimmt, wo kein Schutz der Zehen durch Zehenschutzklappen erforderlich ist.

## KENNZEICHNUNG VON SCHUHEN

- Größe
- Firmenlogo



- Modellbezeichnung des Herstellers
- Seriennummer
- Herstellungsdatum - Jahr und Vierteljahr
- Nummer der Norm
- CE-Zeichen
- Schutzkategorie sowie Kennzeichnung mit zusätzlichen Symbolen, falls zusätzliche Schutzeigenschaften vorhanden sind



**SCHUTZKATEGORIEN DER SCHUHE - GRUNDANFORDERUNGEN**

Kategorien von Schutzschuhen (EN ISO 20345)

Schutzklasse	Zehenschutzkappe schützt gegen Schläge mit 200J	Beständigkeit gegen Dieselöl	Energieaufnahmevermögen im Fersenbereich	Eigenschaften, antistatisch	Geschlossene Ferse	Beständigkeit gegen Durchstich bei einer Kraft von bis zu 1100N	Beschränkte Durchlässigkeit und Absorption von Wasser	Klasse
SB								I
S1								I
S2								I
S3								I
S4*								* II (Schuhwerk Vollkunststoff)
S5*								* II (Schuhwerk Vollkunststoff)

Kategorien von Berufsschuhen (EN ISO 20347)

Schutzklasse	Zehenschutzkappe schützt gegen Schläge mit 200J	Beständigkeit gegen Dieselöl	Energieaufnahmevermögen im Fersenbereich	Eigenschaften, antistatisch	Geschlossene Ferse	Beständigkeit gegen Durchstich bei einer Kraft von bis zu 1100N	Beschränkte Durchlässigkeit und Absorption von Wasser	Klasse
OB	x	x						I
O1	x	x						I
O2	x	x						I
O3	x	x						I
O4*	x	x						* II (Schuhwerk Vollkunststoff)
O5*	x	x						* II (Schuhwerk Vollkunststoff)

**SCHUTZKATEGORIEN DER SCHUHE - ZUSATZANFORDERUNGEN**

Symbol	Zusätzliche Anforderungen
P	Durchstichbeständigkeit bei einer Kraft von bis zu 1100 N
A	Antistatische Eigenschaften
C	Leitfähige Eigenschaften
I	Elektroisolierende Eigenschaften
HI	Wärmeisolierung von unten
CI	Kälteisolierung von unten
E	Energieaufnahme im Fersenbereich
WR	Beschränkte Durchlässigkeit von Wasser für gesamten Schuh
WRU	Beschränkte Durchlässigkeit Absorption von Wasser im Schuhoberteil
HRO	Hitzebeständige Sohle bei kurzem Kontakt (bis 300°C±5°C/ 1min±1s)
CR	Schnittfestigkeit
M	Mittelfußschutz
AN	Fußknöchelschutz
FO	Sohle beständig gegen Dieselöl
SRA	Rutschhemmung auf Keramikböden, die mit Natriumlaurylsulfat (SLS) benetzt sind
SRB	Rutschhemmung auf mit Glycerin benetzten Stahlböden
SRC	Rutschhemmung auf beiden o.g. Bodenarten



PROLINE  
LAHTI PRO  
MEGA  
JUCCO  
OTHER BRANDS  
ERDI  
KLINGSPOR  
EXPRESS  
ACTION CAN  
TRYTON  
VULCAN



... for repairs



# T

The Mega brand is used for economy class products, ideal for occasional use at home. They are fully usable and meet the strength requirements for tools used in occasional repairs and renovations.

Mega tools and accessories allow anyone to easily expand their arsenal of tools, and work quickly and without tool-related problems.

Mega tools and accessories are recommended for households and individuals, who buy them for their own needs. Mega products are synonymous with availability, durability and quality adjusted to amateur needs.

The Mega brand is very popular with various retail outlets. Mega products are a perfect complement to a store's offer, as basic tools every home needs.

Маркой Mega обозначаются продукты эконом-класса, идеально подходящие для домашнего, ситуативного использования. Они обеспечивают полную пригодность к применению и отвечают всем требованиям к прочности, предусмотренным для инструментов, используемых для одноразовых ремонтных работ.

Благодаря инструментам и аксессуарам Mega, любой из нас сможет простым способом расширить свой инструментальный арсенал и таким образом выполнить работу быстро и без хлопот с инструментами.

Инструменты и аксессуары Mega рекомендуются к использованию в домашних хозяйствах и индивидуальным клиентам, покупающим их для личных потребностей. Продукты Mega - это доступность, прочность и качество, соответствующее потребностям любителей.

Марка Mega пользуется большой популярностью среди различных торговых точек. Продукты Mega идеальны как дополнение торгового предложения магазина основными инструментами, необходимыми в каждом доме.

Die Marke Mega zeichnet sich durch Produkte der Economy-Klasse aus, die sich ideal für gelegentliche Anwendungen zu Hause eignen. Sie bieten volle Benutzerfreundlichkeit und erfüllen die Festigkeitsanforderungen an Werkzeuge, die für gelegentliche Reparaturen und Renovierungen verwendet werden.

Dank der Mega-Werkzeuge und des Zubehörs kann jeder problemlos sein Arsenal an Werkzeugen erweitern und somit schnell und ohne Ausrüstungsprobleme arbeiten.

Mega-Werkzeuge und Zubehör werden für Haushalte und Einzelkunden empfohlen, die sie für ihre eigenen Bedürfnisse kaufen. Mega-Produkte stehen für Verfügbarkeit, Haltbarkeit und Qualität, angepasst an die Bedürfnisse von Amateuren.

Die Marke Mega ist bei verschiedenen Einzelhandelsgeschäften sehr beliebt. Mega-Produkte ergänzen das Angebot des Geschäfts optimal mit den Grundwerkzeugen, die in jedem Haushalt benötigt werden.



# MEGA

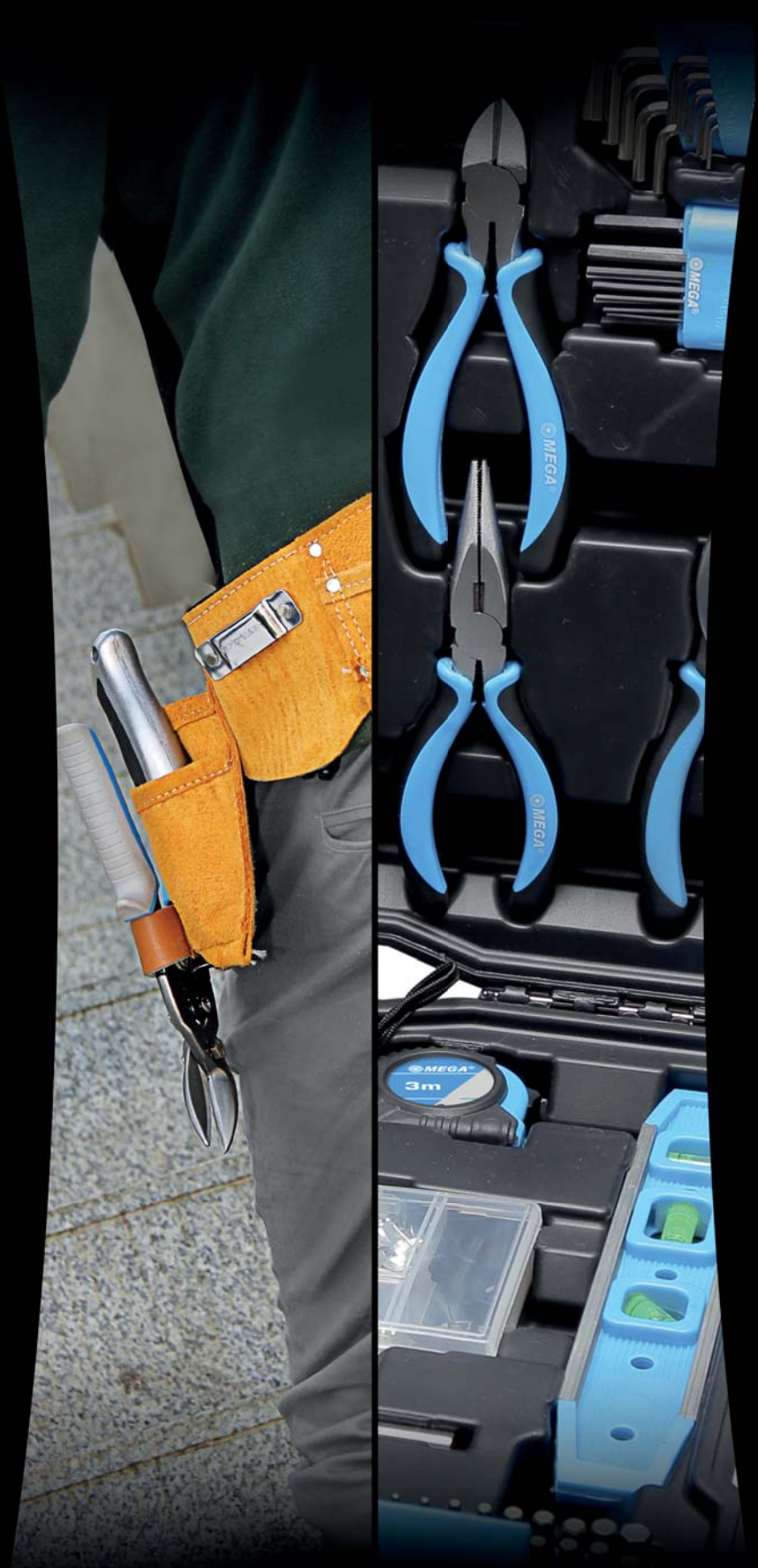

- chisels
- discs
- drills
- hammers
- hole saws
- knives
- measuring tools
- pliers
- riveters
- saws
- screwdrivers
- spanners
- stool sets
- torche
- and many others

### 1 91 PCS TOOL SET

• НАБОР ИНСТРУМЕНТОВ 91 ШТ. • WERKZEUG-SET 91 STK.



**x91 1/4" 1/2" CrV**

- 1/4" 4, 5, 6, 7, 8, 9, 10, 11, 12, 13 mm • 1/4" 6, 7, 8, 10, 13 mm • 1/2" 13, 14, 15, 16, 17, 18, 19, 21, 22, 24 mm
- 1/4" 17, 19, 21, 22 mm • 16, 21 mm • 1/4" • 1/4" • 1/2" • 1/4" 75 mm
- 1/2" 125 mm • 1/4" • 1/2" • 1/4" • 1/2" 5/16" • 1/4" • 6, 8, 10, 11, 13, 14, 15, 17, 19 mm • 1/4" PZ1, PZ2, PZ3 • 2xPH1, 2xPH2, 2xPH3 • 3, 4, 5, 6 mm • T25, T27, T30, T35 • 4, 5, 6 mm • 5/16" PZ1, PZ2, PZ3 • PH1, PH2, PH3 • 5, 6 mm • T25, T27, T30, T35 • 1.5, 2, 2.5, 3, 4, 5, 6, 8, 10 mm

Code	Quantity in the set (pcs.)	
58091	91	4

### 3 82 PCS TOOL SET

• НАБОР ИНСТРУМЕНТОВ 82 ШТ. • WERKZEUG-SET 82 STK.



**x82 1/4" 1/2"**

- 1/4" 4, 4.5, 5, 5.5, 6, 7, 8, 9, 10, 11, 12, 13, 14 mm • 1/2" 14, 15, 16, 17, 18, 19, 20, 21, 24, 27, 30, 32 mm • 1/4" PZ1, PZ2 • PH1, PH2 • 4, 5.5, 7 mm • T8, T10, T15, T20, T25, T30 • 3, 4, 5, 6 mm • 5/16" PZ3, PZ4 • PH3, PH4 • 8, 10, 12 mm • T40, T45, T50, T55 • 8, 10, 12, 14 mm • 8, 10, 11, 12, 13, 14, 17, 19, 22 mm • 1/2" • 1/4"
- 1/4" 50, 100 mm • 1/2" 125, 250 mm
- 1/2" 16, 21 mm • 1/2" 1/4"
- 1/2" • 1/4" • 1/4" • 5/16"
- 1/4" • 1/2"

Code	Quantity in the set (pcs.)	
58082	82	3

### 2 94 PCS TOOL SET

• НАБОР ИНСТРУМЕНТОВ 94 ШТ. • WERKZEUG-SET 94 STK.



**x94 1/4" 1/2"**

- 1/2" 10, 11, 12, 13, 14, 15, 16, 17, 18, 19, 20, 21, 22, 23, 24, 27, 30, 32 mm • 1/2" 14, 15, 17, 19 mm • 1/2" 16, 21 mm • 1/2" 250 mm • 1/2" 158 mm
- 1/2" 250 mm • 1/2" 1/2" 5/16"
- 1/4" 4, 4.5, 5, 5.5, 6, 7, 8, 9, 10, 11, 12, 13, 14 mm • 6, 7, 8, 9, 10, 11, 12, 13 mm • 1/4" PZ1, PZ2 • PH1, PH2 • 4, 5.5, 7 mm • T8, T10, T15, T20, T25, T30 • 3, 4, 5, 6 mm • 5/16" PZ3, PZ4 • PH3, PH4 • 8, 10, 12 mm • T40, T45, T50, T55 • 8, 10, 12, 14 mm • 1/4" • 1/4" • 1/4" 158 mm • 1/2" 50, 100 mm • 1/4" 150 mm
- 1/2" • 1/4" • 1.5, 2, 2.5

Code	Quantity in the set (pcs.)	
58094	94	4

### 4 46 PCS TOOL SET

• НАБОР ИНСТРУМЕНТОВ 46 ШТ. • WERKZEUG-SET 46 STK.



**x46 1/4" CrV**

- 1/4" 4, 4.5, 5, 5.5, 6, 7, 8, 9, 10, 11, 12, 13, 14 mm
- 1/4" PZ1, PZ2, PZ3 • PH1, PH2, PH3 • SL4, SL5.5, SL7 • SQ1, SQ2, SQ3 • T10, T15, T20, T25, T30, T40 • H3, H4, H5, H6, H7, H8 mm • 1/4" • 1/4" 50 mm • 1/4" 100 mm • 1/4" • 1/4" 125 mm • 1/4"
- 1/4" • 1/4" • 1.5, 2.0, 2.5

Code	Quantity in the set (pcs.)	
58046	46	10

### 1 72 PCS TOOL SET

• НАБОР ИНСТРУМЕНТОВ 72 ШТ. • WERKZEUG-SET 72 STK.



**x72 1/4" 1/2" CrV**

- 1/4" 4, 5, 5.5, 6, 7, 8, 10, 11, 12, 13 mm • 1/2" 10, 11, 12, 13, 14, 15, 16, 17, 18, 19, 20, 21, 22, 23, 24, 27 mm
- 1/4" PZ0, PZ1, PZ2, PZ3 PH0, PH1, PH2, PH3 SL3, SL4, SL4.5, SL5, SL6, SL6.5, SL7 SQ1, SQ2, SQ3 T8, T9, T10, T15, T20, T25, T27, T30, T40 H2, H3, H4, H5, H5.5, H6 mm • 1/2" 125, 250 mm • 1/2" 21 mm • 1/2" 1/2" 1/2"
- 1/4" • 1/4" • 1.5, 2.0, 2.5

Code	Quantity in the set (pcs.)	
58072	72	3

### 3 144 PCS TOOL SET

• НАБОР ИНСТРУМЕНТОВ 144 ШТ. • WERKZEUG-SET 144 STK.



**x144 1/4"**

- 1/4" 5, 6, 7, 8, 9, 10, 11, 12, 13 mm • 1/4" 60 mm
- 1/4" 200 mm • 1.27, 1.5, 2, 2.5, 3, 3.5, 4, 4.5, 5, 5.5, 6 mm • 0.05, 1/16, 5/64, 3/32, 7/64, 1/8, 9/64, 5/32, 3/16, 7/32 • 2x100, 1x75
- 6x100, 5x75 • 00, 0 • 2.0, 2.4
- 160 mm • 150 mm • 160 mm • 150 mm • 50 mm • x 10 • 3 m
- 13 oz • 225 mm • x 2 •
- AD 25 mm • 1/4" H1.5, H2, H2.5, H3, H4, H5, H5.5, H6, H7, H8 H1.5, H2, H2.5, H3, H3.5, H4, H4.5, H5, H5.5, H6 H2, H2.5, H3, H4, H5, H6 T8, T10, T15, T20, T25, T30, T40 T8, T10, T15, T20, T25, T30, T40 PZ0, 2 x PZ1, 4 x PZ2, 3 x PZ3 PH0, 2 x PH1, 3 x PH2, 3 x PH3 3, 4, 4.5, 5, 5.5, 6, 6.5, 7, 8 mm S0, S1, S2, S3 SP4, SP6, SP8, SP10 M5, M6, M8

Code	Quantity in the set (pcs.)	
58144	144	3

### 2 75 PCS TOOL SET

• НАБОР ИНСТРУМЕНТОВ 75 ШТ. • WERKZEUG-SET 75 STK.



**x75 1/4" 1/2" CrV**

- 1/4" 4, 4.5, 5, 5.5, 6, 7, 8, 9, 10, 11, 12, 13 mm • 1/2" 13, 14, 15, 16, 17, 18, 19, 21, 22, 24 mm • 16, 21 mm
- 1/4" • 1/2" • 1/2" • 1/4" • 1/2" 3/8" • 1/4" 100 mm • 1/4"
- 300g • 2x100, 1x100, 1x75 • 8, 10, 13, 14, 15, 17 mm • 155 mm • 190 mm • 1/4" PZ0, PZ1, PZ2, PZ3, PZ4 PH0, PH1, PH2, PH3, PH4 3, 4, 5, 6, 7 mm T10, T15, T20, T25, T27, T30, T40 1.5, 2, 2.5, 3, 4, 5, 6, 7 mm • 1.5, 2.3 mm

Code	Quantity in the set (pcs.)	
58075	75	4

**1 85 PCS TOOL SET**

• НАБОР ИНСТРУМЕНТОВ 85 ШТ. • WERKZEUG-SET 85 STK.



**x85 1/4"**

- 1/4" 4, 4.5, 5, 5.5, 6, 6.5, 7, 8, 9, 10, 11, 12, 13, 14 mm • 1/4" 70 mm • 1/4" • 1/4"
- 8, 10, 12, 13, 14, 17 mm • 1.5, 2, 2.5, 3, 4, 5, 5.5, 6 mm • 2x100, 1x75 • 6x100, 5x75
- 0.1, 2.0, 2.4 • 163 mm • 162 mm • 156 mm • 13 oz • AD 25 mm • 1/4"
- H1.5, H2, H3, H4, H5, H6, H7, H8 • T8, T10, T15, T20, T25, T27, T30, T35, T40 • PZ0, PZ1, PZ2, PZ3 • PH0, PH1, PH2, PH3, PH4 • 3, 4, 4.5, 5, 5.5, 6, 6.5, 7, 8 mm • S0, S1, S2, S3
- ACCESSORIES • 5m

Code	Quantity in the set (pcs.)	
58085	85	4

**2 27 PCS TOOL SET**

• НАБОР ИНСТРУМЕНТОВ 27 ШТ. • WERKZEUG-SET 27 STK.



**x27**

- 1.5, 2, 2.5, 3, 4, 5, 5.5, 6, 8, 10 mm • PH1x75, PH2x100 • 4x75 • PH1 - SL3, PH00 - SL1.5, PH0 - SL2.5 • 205 mm • 245 mm • 165 mm • 170 mm • 165 mm • 180 mm • 255 mm • x3 • 1 • 300g • 3m

Code	Quantity in the set (pcs.)	
58027	27	4



### 1 COMBINATION SPANNERS

- КОМБИНИРОВАННЫЕ ГАЕЧНЫЕ РОЖКОВО-НАКИДНЫЕ КЛЮЧИ
- MAULRINGSCHLÜSSEL



CrV

- Forged • Chromium-plated • Ground

Code	Size (mm)	
35256	6	500
35257	7	500
35258	8	500
35259	9	500
35260	10	350
35261	11	300
35262	12	250
35263	13	250
35264	14	200
35265	15	200
35266	16	100
35267	17	100
35268	18	100
35269	19	100
35270	20	100
35271	21	50
35272	22	50
35273	23	50
35274	24	50
35277	27	25
35280	30	25
35282	32	25
35284	34	20
35286	36	10
35288	38	10
35291	41	10
35296	46	10
35300	50	5

### 2 COMBINATION SPANNER SET

- НАБОР КОМБИНИРОВАННЫХ ГАЕЧНЫХ РОЖКОВО-НАКИДНЫХ КЛЮЧЕЙ • MAULSCHLÜSSELSÄTZE



CrV

- Forged • Chromium-plated • Ground
- 24 pcs.: 6, 7, 8, 9, 10, 11, 12, 13, 14, 15, 16, 17, 18, 19, 20, 21, 22, 23, 24, 26, 27, 28, 30, 32 mm

Code	Quantity (pcs.)	Range (mm)	
35344	24	6 - 32	4

### 3 COMBINATION SPANNER SETS

- НАБОРЫ КОМБИНИРОВАННЫХ ГАЕЧНЫХ РОЖКОВО-НАКИДНЫХ КЛЮЧЕЙ • MAULRINGSCHLÜSSEL



CrV

- Forged • Chromium-plated • Ground
- 6 pcs.: 8, 9, 10, 13, 14, 17 mm
- 8 pcs.: 6, 8, 9, 10, 13, 14, 17, 19 mm
- 12 pcs.: 6, 7, 8, 9, 10, 11, 12, 13, 14, 17, 19, 22 mm

Code	Quantity (pcs.)	Range (mm)	
35336	6	8 - 17	20
35338	8	6 - 19	20
35342	12	6 - 22	10

### 4 COMBINATION RATCHET SPANNERS

- КОМБИНИРОВАННЫЕ ГАЕЧНЫЕ РОЖКОВО-НАКИДНЫЕ КЛЮЧИ
- MAULRINGSCHLÜSSEL MIT RATSCHE



72

CrV

- Forged • Chromium-plated • Ground

Code	Size (mm)	
35668	8	5/200
35669	9	5/200
35670	10	5/200
35671	11	5/200
35672	12	5/200
35673	13	5/100
35674	14	5/100
35675	15	5/100
35676	16	5/100
35677	17	5/50
35678	18	5/50
35679	19	5/50

### 5 DOUBLE OPEN END SPANNERS

- КЛЮЧИ ГАЕЧНЫЕ РОЖКОВЫЕ • MAULSCHLÜSSEL



CrV

- Forged • Chromium-plated • Ground

Code	Size (mm)	
34436	6 x 7	300
34438	8 x 9	300
34439	8 x 10	300
34440	10 x 11	250
34441	10 x 13	200
34442	12 x 13	200
34443	13 x 17	100
34444	14 x 15	200
34446	16 x 17	100
34447	17 x 19	100
34448	18 x 19	100
34449	19 x 22	100
34450	20 x 22	100
34451	21 x 23	50
34454	24 x 27	50
34455	25 x 28	40
34457	27 x 32	30
34460	30 x 32	30

### 6 DOUBLE OPEN END SPANNER SET

- НАБОР ГАЕЧНЫХ РОЖКОВЫХ КЛЮЧЕЙ • MAULSCHLÜSSELSATZ



CrV

- Forged • Chromium-plated • Ground
- 12 pcs.: 6 x 7, 8 x 9, 10 x 11, 12 x 13, 14 x 15, 16 x 17, 18 x 19, 20 x 22, 21 x 23, 24 x 27, 25 x 28, 30 x 32 mm

Code	Quantity (pcs.)	Range (mm)	
34432	12	6 x 7 - 30 x 32	6

### 7 STUBBY COMBINATION SPANNERS

- КОМБИНИРОВАННЫЕ КОРОТКИЕ ГАЕЧНЫЕ РОЖКОВО-НАКИДНЫЕ КЛЮЧИ • MAULRINGSCHLÜSSEL KURZ



CrV

- Forged • Chromium-plated • Ground

Code	Size (mm)	Length (mm)	
35240	10	96	500
35241	11	100	400
35242	12	106	400
35243	13	110	240
35244	14	116	200
35245	15	126	100
35246	16	126	100
35247	17	130	100
35248	18	131	100
35249	19	142	100

**1 DOUBLE OPEN END SPANNER SET**

• НАБОРЫ ГАЕЧНЫХ РОЖКОВЫХ КЛЮЧЕЙ • MAULSCHLÜSSELSATZ



**CrV**

- Forged • Chromium-plated • Ground
- **6 pcs.:** 6 x 7, 8 x 9, 10 x 11, 12 x 13, 14 x 15, 16 x 17 mm,
- **8 pcs.:** 6 x 7, 8 x 9, 10 x 11, 12 x 13, 14 x 15, 16 x 17, 18 x 19, 20 x 22 mm

Code	Quantity (pcs.)	Range (mm)	
34426	6	6 x 7 - 16 x 17	20
34428	8	6 x 7 - 20 x 22	20

**2 STUBBY COMBINATION SPANNER SET**

• НАБОР КОМБИНИРОВАННЫХ КОРОТКИХ ГАЕЧНЫХ РОЖКОВО-НАКИДНЫХ КЛЮЧЕЙ • MAULRINGSCHLÜSSELSATZ KURZ



**CrV**

- Forged • Chromium-plated • Ground
- **6 pcs.:** 10, 12, 13, 14, 15, 17 mm

Code	Quantity (pcs.)	Range (mm)	
35236	6	10 - 17	40

**3 RING SPANNERS**

• КЛЮЧИ ГАЕЧНЫЕ НАКИДНЫЕ ИЗОГНУТЫЕ • RINGSCHLÜSSEL GEKRÖPFT



**CrV**

- Forged • Chromium-plated • Ground

Code	Size (mm)	
36536	6 x 7	300
36538	8 x 9	300
36540	10 x 11	200
36542	12 x 13	150
36544	14 x 15	100
36546	16 x 17	100
36548	18 x 19	50
36550	20 x 22	50
36551	21 x 23	50
36554	24 x 27	50
36555	25 x 28	40
36560	30 x 32	25

**4 RING SPANNER SET**

• НАБОР ГАЕЧНЫХ НАКИДНЫХ ИЗОГНУТЫХ КЛЮЧЕЙ • RINGSCHLÜSSELSÄTZE GEKRÖPFT



**CrV**

- Forged • Chromium-plated • Ground
- **12 pcs.:** 6 x 7, 8 x 9, 10 x 11, 12 x 13, 14 x 15, 16 x 17, 18 x 19, 20 x 22, 21 x 23, 24 x 27, 25 x 28, 30 x 32 mm

Code	Quantity (pcs.)	Range (mm)	
36532	12	6 x 7 - 30 x 32	5

**5 RING SPANNER SETS**

• НАБОРЫ ГАЕЧНЫХ НАКИДНЫХ ИЗОГНУТЫХ КЛЮЧЕЙ • RINGSCHLÜSSELSÄTZE GEKRÖPFT



**CrV**

- Forged • Chromium-plated • Ground
- Composition of sets:  
**6 pcs.:** 6 x 7, 8 x 9, 10 x 11, 12 x 13, 14 x 15, 16 x 17 mm  
**8 pcs.:** 6 x 7, 8 x 9, 10 x 11, 12 x 13, 14 x 15, 16 x 17, 18 x 19, 20 x 22 mm

Code	Quantity (pcs.)	Range (mm)	
36526	6	6 x 7 - 16 x 17	20
36528	8	6 x 7 - 20 x 22	10

**6 SPARK PLUG WRENCHES**

• КЛЮЧИ СВЕЧНЫЕ С КАРДАНОМ • ZÜNDKERZENSCHLÜSSEL



- Forged sockets • Joint

Code	Size (mm)		
29056	16	x	10/50
29051	21	x	10/50

**7 DOUBLE OPEN END SPANNERS**

• КЛЮЧИ ГАЕЧНЫЕ РОЖКОВЫЕ • MAULSCHLÜSSEL



- Carbon steel • Chromium-plated • Bulk

Code	Size (mm)	
34081	8 x 10	250/1000
34103	10 x 13	100/400
34137	13 x 17	50/200
34179	17 x 19	30/120
34192	19 x 22	30/120
34247	24 x 27	25/100
34272	27 x 32	15/60
34282	30 x 32	15/60

**8 DOUBLE OPEN END SPANNERS**

• КЛЮЧИ ГАЕЧНЫЕ РОЖКОВЫЕ • MAULSCHLÜSSEL



- Carbon steel • Chromium-plated
- Composition of sets:  
**6 pcs.:** 6 x 7, 8 x 9, 10 x 11, 12 x 13, 14 x 15, 16 x 17 mm  
**8 pcs.:** 6 x 7, 8 x 9, 10 x 11, 12 x 13, 14 x 15, 16 x 17, 18 x 19, 20 x 22 mm  
**12 pcs.:** 6 x 7, 8 x 9, 10 x 11, 12 x 13, 14 x 15, 16 x 17, 18 x 19, 20 x 22, 21 x 23, 24 x 27, 25 x 28, 30 x 32 mm
- Packed in foil
- **34012H** with additional clip

Code	Quantity (pcs.)	Range (mm)	
34006H	6	6x7 - 16x17	20/80
34008H	8	6x7 - 20x22	10/40
34012H	12	6x7 - 30x32	5/20

**9 COMBINATION SPANNER SETS**

• КОМБИНИРОВАННЫЕ ГАЕЧНЫЕ РОЖКОВО-НАКИДНЫЕ КЛЮЧИ • MAULSCHLÜSSELSÄTZE



- Carbon steel • Chromium-plated
- Composition of sets:  
**6 pcs.:** 8, 9, 10, 13, 14, 17 mm;  
**8 pcs.:** 6, 8, 9, 10, 13, 14, 17, 19 mm;  
**12 pcs.:** 6, 7, 8, 9, 10, 11, 12, 13, 14, 17, 19, 22 mm • Packed in foil
- **35012H** with additional clip

Code	Quantity (pcs.)	Range (mm)	
35006H	6	8 - 17	15/60
35008H	8	6 - 19	10/40
35012H	12	6 - 22	5/20

### 1 COMBINATION SPANNERS

- КОМБИНИРОВАННЫЕ ГАЕЧНЫЕ РОЖКОВО-НАКИДНЫЕ КЛЮЧИ
- MAULRINGSCHLÜSSEL



- Forged • Chromium-plated • Ground

Code	Size (mm)	
35606H	6	250/1000
35607H	7	200/800
35608H	8	200/800
35609H	9	150/600
35610H	10	150/600
35611H	11	100/400
35612H	12	100/400
35613H	13	60/240
35614H	14	50/200
35615H	15	50/200
35616H	16	50/200
35617H	17	50/200
35618H	18	50/200
35619H	19	25/100
35620H	20	25/100
35621H	21	25/100
35622H	22	25/100
35623H	23	25/100
35624H	24	15/80
35625H	25	15/60
35626H	26	15/60
35627H	27	15/60
35628H	28	15/60
35630H	30	10/40
35632H	32	10/40

### 2 COMBINATION SPANNER SETS

- КОМБИНИРОВАННЫЕ ГАЕЧНЫЕ РОЖКОВО-НАКИДНЫЕ КЛЮЧИ
- MAULSCHLÜSSELSÄTZE



- Carbon steel • Chromium-plated
- Composition of sets: 6, 7, 8, 9, 10, 11, 12, 13, 14, 17, 19, 22 mm

Code	Quantity (pcs.)	Range (mm)	
35112H	12	6 - 22	5/20

### 3 COMBINATION SPANNER SET

- НАБОР КОМБИНИРОВАННЫХ ГАЕЧНЫХ РОЖКОВО-НАКИДНЫХ КЛЮЧЕЙ • KOMBINATIONSSCHLÜSSEL-SET



- Carbon steel • Chromium-plated
- Composition of set: 6, 7, 8, 9, 10, 11, 12, 13, 14, 15, 16, 17, 18, 19, 20, 21, 22, 23, 24, 25, 26, 27, 28, 30, 32 mm

Code	Quantity (pcs.)	Range (mm)	
35125H	25	6 - 32	4

### 4 OFFSET RING SPANNER SET

- НАБОРЫ ГАЕЧНЫХ НАКИДНЫХ ИЗОГНУТЫХ КЛЮЧЕЙ
- RINGSCHLÜSSELSÄTZE GEKRÖPFT



- Carbon steel • Chromium-plated
- Composition of sets:
  - 6 pcs. - 6 x 7, 8 x 9, 10 x 11, 12 x 13, 14 x 15, 16 x 17 mm;
  - 8 pcs. - 6 x 7, 8 x 9, 10 x 11, 12 x 13, 14 x 15, 16 x 17, 18 x 19, 20 x 22 mm;
  - 12 pcs. - 6 x 7, 8 x 9, 10 x 11, 12 x 13, 14 x 15, 16 x 17, 18 x 19, 20 x 22, 21 x 23, 24 x 27, 25 x 28, 30 x 32 mm
- Packed in foil
- 36008H, 36012H with additional clip

Code	Quantity (pcs.)	Range (mm)	
36006H	6	6x7 - 16x17	8/32
36008H	8	6x7 - 20x22	5/20
36012H	12	6x7 - 30x32	2/8

### 5 TUBULAR WRENCHES

- ТРУБНЫЕ КЛЮЧИ • ROHRSCHLÜSSEL



- Standard length wrenches • Forged
- Chromium-plated • Satin • Composition of sets:
  - 6 pcs. - 8x9, 10x11, 12x13, 14x15, 16x17, 18x19, 20x22, 2 madrels;
  - 10 pcs. - 6x7, 8x9, 10x11, 12x13, 14x15, 16x17, 18x19, 20x22, 2 madrels

Code	Quantity (pcs.)	Range (mm)		
36206	6	8-17	x	6/30
36210	10	6-22	x	6/24

### 6 PIPE SPANNERS

- КЛЮЧИ ДВОЙНЫЕ ТОРЦЕВЫЕ ИЗОГНУТЫЕ
- WINKELDURCHSTECKSCHLÜSSEL



- Forged • Pipe débouchée pans

Code	Size (mm)	
34908	8	20/240
34910	10	20/240
34912	12	20/200
34913	13	20/200
34914	14	10/100
34915	15	10/100
34917	17	10/100
34919	19	10/100
34922	22	10/100
34924	24	10/100

### 7 L-TYPE WHEEL WRENCH

- Б АЛЛОННЫЙ КЛЮЧ ТЕЛЕСКОПИЧЕСКИЙ
- RADSCHLÜSSEL



- Two-sided forged socket made from CrV steel
- Telescopic
- Arm length 350 - 530 mm

Code	Size (mm)		
29006	17/19	x	6/24

### 8 RATCHET SCAFFOLD SPANNER

- КЛЮЧ ДЛЯ СТРОИТЕЛЬНЫХ ЛЕСОВ С ТРЕШОТКОЙ
- KNARREN-GERÜSTSCHLÜSSEL

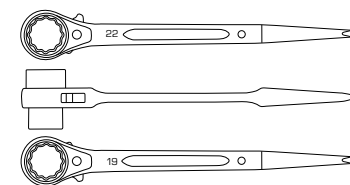

- Forged • Chrome • Satin • Designed for use in assembling and disassembling scaffolding • Long, contoured handle facilitates lifting and separating pieces of scaffolding • The opening in the handle makes it possible to attach and secure the wrench when working at heights

Code	Size (mm)		
36742	19x22	x	2/50

**1 HEXAGON KEY SETS**

- НАБОР ТОРЦЕВЫХ ШЕСТИГРАННЫХ КЛЮЧЕЙ
- SECHSKANTSCHLÜSSELSATZ



- High-grade tool steel • Blackened
- Delivered in plastic case
- **9 pcs.:** 1.5, 2, 2.5, 3, 4, 5, 6, 8, 10 mm

Code	Quantity (pcs.)	Range (mm)		
48049	9	1.5 - 10	x	25/100

**2 BALL END HEXAGON SPANNER SET**

- НАБОРЫ ТОРЦЕВЫХ ШЕСТИГРАННЫХ КЛЮЧЕЙ С ШАРОВЫМ НАКОНЕЧНИКОМ
- SECHSKANTSCHLÜSSELSATZ MIT KUGELN



- High-grade tool steel
- Blackened
- Delivered in plastic case
- The ball end enables to use the spanner at the angle of up to 30° to the bolt plane
- **7 pcs.:** 2.5, 3, 4, 5, 6, 8, 10 mm
- **10 pcs.:** 1.5, 2, 2.5, 3, 3.5, 4, 5, 6, 8, 10 mm

Code	Quantity (pcs.)	Range (mm)		
48207	7	2.5 - 10.0	x	20/40
48210	10	1.5 - 10.0	x	10/40

**3 CROSS-RIM WRENCH**

- КЛЮЧ БАЛОННЫЙ КРЕСТОВОЙ
- RADKREUZ

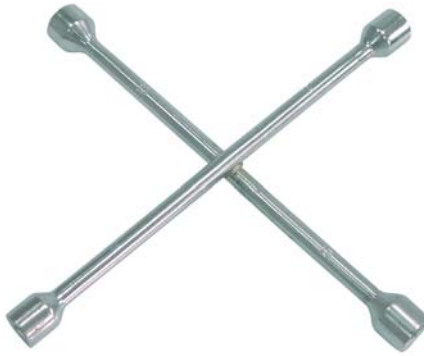

- Forged • Chromium-plated • Rod Ø 16 mm

Code	Size (mm)	
29001	17 x 19 x 22 x 13 / 16"	15

**6 HEAVY-DUTY CROSS-RIM WRENCH**

- КЛЮЧ БАЛОННЫЙ КРЕСТОВОЙ УСИЛЕННЫЙ
- RADKREUZ VERSTÄRKT



- Forged • Coated • Rod Ø 16 mm

Code	Size (mm)	
29003	17 x 19 x 22 x square 1/2"	10

**4 HEXAGON KEY SETS**

- НАБОРЫ ТОРЦЕВЫХ ШЕСТИГРАННЫХ КЛЮЧЕЙ
- SECHSKANTSCHLÜSSELSATZ



Code	Quantity (pcs.)	Range (mm)		
48008	8	1.5 - 6.0	x	50/200
48018	8	2.0 - 10.0	x	25/100
48010	10	1.5 - 10.0	x	25/100
48012	12	2.0 - 14.0	x	20/40

- High-grade tool steel • Blackened
- **8 pcs.:** 1.5, 2, 2.5, 3, 3.5, 4, 5, 6 mm
- **8 pcs.:** 2, 2.5, 3, 4, 5, 6, 8, 10 mm
- **10 pcs.:** 1.5, 2, 2.5, 3, 4, 5, 5.5, 6, 8, 10 mm
- **12 pcs.:** 2, 2.5, 3, 3.5, 4, 5, 5.5, 6, 8, 10, 12, 14 mm

**5 T-HANDLE HEX SPANNER SET**

- НАБОР ТОРЦЕВЫХ ШЕСТИГРАННЫХ КЛЮЧЕЙ С Т-ОБРАЗНОЙ РУКОЯТКОЙ
- SECHSKANTSCHLÜSSELSATZ MIT T-GRIFFEN



- Blackened, with T handle • Blackened • Delivered with a steel support
- **10 pcs.:** 2, 2.5, 3, 4, 4.5, 5, 5.5, 6, 8, 10 mm

Code	Quantity (pcs.)	Range (mm)		
48110	10	2 - 10	x	20

CrV

### 1 T-HANDLE SPANNER SET

• НАБОР ТОРЦЕВЫХ ШЕСТИГРАННЫХ КЛЮЧЕЙ С Т-ОБРАЗНОЙ РУКОЯТКОЙ • SECHSKANTSCHLÜSSELSATZ MIT T-GRIFFEN



- H2, H2.5, H3, H4, H5, H6, H8
- T10, T15, T20, T25, T30, T40, T45

**S2 CrV SOFT TOUCH**

- Torx spanners made from S2 steel and HEX spanners from CrV steel • Quenched
- Two-component non-slip handle SOFT TOUCH

Code	Quantity [pcs.]		
48600	14	x	12/120

### 2 T-HANDLE HEX SPANNER SET

• НАБОР ТОРЦЕВЫХ ШЕСТИГРАННЫХ КЛЮЧЕЙ С Т-ОБРАЗНОЙ РУКОЯТКОЙ • SECHSKANTSCHLÜSSELSATZ MIT T-GRIFFEN



**CrV SOFT TOUCH**

- Made from CrV steel, quenched • Two-component non-slip handle SOFT TOUCH

Code	Bit [number x length mm]		
48601	H2 x 75	x	12/120
48602	H2.5 x 75	x	12/120
48603	H3 x 100	x	12/120
48604	H4 x 100	x	12/120
48605	H5 x 150	x	12/120
48606	H6 x 150	x	12/120
48607	H8 x 200	x	12/48
48608	H10 x 200	x	12/48

### 3 TORX KEYS WITH T HANDLE

• КЛЮЧИ СТЕРЖНЕВЫЕ



**SOFT TOUCH**

- Made from CrV steel, quenched
- Two-component non-slip handle SOFT TOUCH

Code	Bit (type x length mm)		
48611	T10 x 75	x	12/120
48612	T15 x 75	x	12/120
48613	T20 x 100	x	12/120
48614	T25 x 100	x	12/120
48615	T30 x 150	x	12/120
48616	T40 x 150	x	12/120
48617	T45 x 200	x	12/48
48618	T50 x 200	x	12/48

### 4 SECURITY BIT SET 1/4"

• НАБОР БИТОВ 1/4" С МАГНИТНЫМ БИТОДЕРЖАТЕЛЕМ • SPEZIAL-BITS-SET, "SECURITY" 1/4"



**CrV**

- 33 pcs.: • TORX Security T8, T10, T15, T20, T25, T27, T30, T35, T40 • 2, 2.5, 3, 4, 5, 6 mm, 5/64", 3/32", 7/64", 1/8"
- Other special • 1/4" • 60 mm

Code	Quantity [pcs.]		
10733	33	x	12/72

### 5 BIT SET 1/4"

• НАБОР БИТОВ 1/4" С МАГНИТНЫМ БИТОДЕРЖАТЕЛЕМ • BITS-SET 1/4"



**CrV**

- 33 pcs.: • PH 0, PH 1 x 2, PH 2 x 2, PH 3 x 2 • PZ 0, PZ 1 x 2, PZ 2 x 2, PZ 3 x 2 • 3, 4, 5, 6, 7 mm • TORX T10, T15, T20, T25, T27, T30, T40 • 2, 3, 4, 5, 5.5, 6 mm
- 1/4" • 60 mm • Magnetic holder

Code	Quantity [pcs.]		
10734	33	x	12/72

### 6 XZN, TORX AND HEX BIT SET, 40 PCS.

• НАБОР ОТВЕРТОЧНЫХ БИТОВ – 40 ШТ. • BITS-SET XZN, TORX UND IMBUS



**Cr**

- 40 pcs.: • 1/2" • 5/16" • 3/8" • 5/16" • 5/16" • 30 x 75 mm T20, T25, T30, T40, T45, T50, T55 • 4, 5, 6, 7, 8, 10, 12 mm • 30 x 75 mm M5, M6, M8, M10, M12

Code	Quantity [pcs.]		
10740	40		10

### 7 MAGNETIC BIT HOLDER 1/4"

• ДЕРЖАТЕЛЬ ДЛЯ БИТ • MAGNETBITHALTER



**CrV SOFT TOUCH**

- Bits made from CrV steel, quenched
- Two-component non-slip handle SOFT TOUCH
- Magnetic bit tips

Code	Bit [number x length mm]	
10950	1/4" x 100	12/120

### 8 SCREWDRIVERS „SOFT TOUCH“

• ОТВЕРТКА • NORPENSCHRAUBENDREHER



**CrV SOFT TOUCH**

- Bits made from CrV steel, quenched
- Two-component non-slip handle SOFT TOUCH
- Magnetic bit tips

Code	Bit [number x length mm]	
	SLOTTED ⊕	
10951	PH0 x 63	12/120
10952	3.2 X 75	12/120
10954	5.0 x 100	12/120
10956	6.0 x 38	12/120
10957	6.0 x 100	12/120
10959	8.0 x 150	12/96
	PHILLIPS (PH) ⊕	
10965	PH0 x 75	12/120
10966	PH1 x 100	12/120
10967	PH2 x 38	12/120
10968	PH2 x 100	12/120
10970	PH3 x 150	12/96
	POZIDRIV (PZ) ⊕	
10975	PZ0 x 75	12/120
10976	PZ1 x 100	12/120
10977	PZ2 x 38	12/120
10978	PZ2 x 100	12/120
10980	PZ3 x 150	12/96
	TORX (T) ⊕	
10985	T6 x 75	12/120
10986	T7 x 75	12/120
10987	T8 x 75	12/120
10988	T9 x 75	12/120
	TORX SECURITY (TS) ⊕	
10990	TS10 x 100	12/120
10991	TS15 x 100	12/120
10992	TS20 x 100	12/120
10993	TS25 x 100	12/120
10994	TS27 x 100	12/120
10995	TS30 x 100	12/120

**1 50 PCS „SOFT TOUCH”  
SCREWDRIVER SET**

- НАБОР ОТВЕРТОК И БИТ – 50 ШТ.
- NOPPENSCHRAUBENDREHER - AUSSTELLUNGSSET 50 STK.



Magnetic



**x50 CrV** **MAGNETIZER** **SOFT TOUCH**

- Stand with screwdrivers, bits and magnetiser • Screwdriver bits and bit shanks made of chrome-vanadium steel, tempered • SOFT TOUCH, non-slip two-material handles • Magnetic screwdriver bit tip
- $\ominus$  6.5x38, 4.0x75, 6.5x100, 8.0x150  $\oplus$  PH2x38, PH1x75, PH2x100, PH3x150  $\otimes$  Bit Holder 6.3x75mm
- $\ominus$  2.0x75, 2.5x75, 3.0x75  $\oplus$  PH00x75, PH0x75  $\otimes$  T6x75, T8x75, T10x75 •  $\oplus$  3, 4, 5, 6  $\otimes$  0, 1, 2, 3  $\oplus$  0, 1, 2, 3  $\otimes$  H2, H2.5, H3, H4, 2xH5, H5.5, H6  $\otimes$  T8, T10, T15, T20, T25, T27, T30, T40  $\otimes$  0, 1, 2, 3

Code	Quantity (pcs.)		
10999	50	x	10

**2 5 PCS. SCREWDRIVER SET**

- НАБОР ОТВЕРТОК – 5 ШТ.
- NOPPENSCHRAUBENDREHER - SET 5 STK.



**CrV**

- Non-slip handles with rubber inserts
- Magnetic bit tips
- 5 pcs.:  $\oplus$  PH 1 x 100, PH 2 x 150 mm  $\ominus$  4 x 100, 5 x 125, 6 x 150 mm

Code	Quantity (pcs.)		
10051	5	x	12/48

**3 SCREWDRIVERS**

- ОТВЕРТКИ - NOPPENSCHRAUBENDREHER



**CrV**

- Bits made from CrV steel, quenched
- Non-slip handles with rubber inserts
- Magnetic bit tips

**4 126 PCS. DISPLAY SCREWDRIVER SET**

- ЭКСПОЗИЦИОННЫЙ НАБОР ОТВЕРТОК – 126 ШТ.
- NOPPENSCHRAUBENDREHER - AUSSTELLUNGSSET 126 STK.

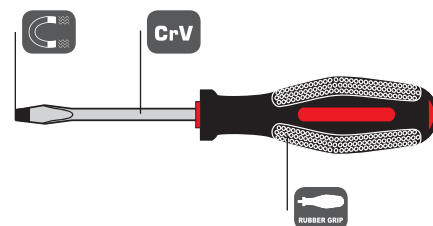

RUBBER GRIP

**CrV**

- $\oplus$  PH 0 x 75 mm - 12 pcs., PH 1 x 75 mm - 8 pcs., PH 2 x 100 mm - 10 pcs., PH 3 x 150 mm - 8 pcs.
- $\oplus$  PZ 0 x 75 mm - 8 pcs., PZ 1 x 75 mm - 8 pcs., PZ 2 x 100 mm - 10 pcs., PZ 3 x 150 mm - 8 pcs.
- $\ominus$  3 x 75 mm - 12 pcs., 4 x 100 mm - 8 pcs., 5 x 75 mm - 8 pcs., 6 x 100 mm - 8 pcs., 6 x 150 mm - 10 pcs., 8 x 200 mm - 8 pcs.

- Screwdriver rack
- Non-slip handles with rubber inserts
- Magnetic bit tips
- 126 pcs.:

Code	Quantity (pcs.)		
10050	126		2

- Slotted



Code	Bit (number x length mm)	
10043	3 x 75	12/480
10044	4 x 100	12/480
10045	5 x 75	12/240
10046	6 x 100	12/180
10047	6 x 150	12/180
10048	8 x 200	12/120
ZR10043	3 x 75	12/480
ZR10044	4 x 100	12/480
ZR10045	5 x 75	12/240
ZR10046	6 x 100	12/180
ZR10047	6 x 150	12/180
ZR10048	8 x 200	12/120

- Phillips (PH)



Code	Bit (number x length mm)	
10330	PH0 x 75	12/480
10331	PH1 x 75	12/240
10332	PH2 x 100	12/180
10333	PH3 x 150	12/120
ZR10330	PH0 x 75	12/480
ZR10331	PH1 x 75	12/240
ZR10332	PH2 x 100	12/180
ZR10333	PH3 x 150	12/120

- Pozidriv (PZ)



Code	Bit (number x length mm)	
10490	PZ0 x 75	12/480
10491	PZ1 x 75	12/240
10492	PZ2 x 100	12/180
10493	PZ3 x 150	12/120
ZR10490	PZ0 x 75	12/480
ZR10491	PZ1 x 75	12/240
ZR10492	PZ2 x 100	12/180
ZR10493	PZ3 x 150	12/120



**1 REVERSIBLE BLADE SCREWDRIVER**  
 • ДВУХСТОРОННЯЯ ОТВЕРТКА • SCHRAUBENDREHER MIT UMWENDBARER KLINGE



- Removable double-sided blade:  
 $\varnothing$  PH 2 i  $\varnothing$  6 mm
- Plastic handle

Code	Type		
10000	double-sided	x	50/100

**2 11 PCS. JEWELLER'S SCREWDRIVER SET**  
 • НАБОР ОТВЕРТОК ДЛЯ ТОЧНОЙ МЕХАНИКИ – 11 ШТ.  
 • UHRMACHERSCHRAUBENDREHER - SET 11 STK.



- The set includes:  $\varnothing$  PH 00, 0, 1  $\varnothing$  1.0, 1.2, 1.4, 1.8, 2.4, 3.0 mm, spit, magnet
- Delivered in a plastic case

Code	Quantity (pcs.)		
10221	11	x	20/100

**3 6 PCS. JEWELLER'S SCREWDRIVER SET**  
 • НАБОР ОТВЕРТОК ДЛЯ ТОЧНОЙ МЕХАНИКИ – 6 ШТ.  
 • UHRMACHERSCHRAUBENDREHER - SET 6 STK.



- The set includes:  
 $\varnothing$  PH 0, 1  $\varnothing$  1.4, 1.8, 2.4, 3.0 mm
- Delivered in a plastic case

Code	Quantity (pcs.)		
10206	6	x	20/100

**4 IMPACT SCREWDRIVER SET**  
 • УДАРНАЯ ОТВЕРТКА • SCHLAGSCHRAUBENDREHER



- Two-sided operation – leftwards and rightwards
- $\varnothing$  25 mm  $\varnothing$  PH 2, 3  $\varnothing$  7, 8 mm  $\varnothing$  50 mm  $\varnothing$  PH 2  $\varnothing$  8 mm
- Delivered in plastic box

Code	Quantity (pcs.)	
10007	6	25

**5 6 PCS PRECISION SCREWDRIVER SET**  
 • НАБОР ОТВЕРТОК ДЛЯ ТОЧНОЙ МЕХАНИКИ – 6 ШТ.  
 • PRÄZISIONSSCHRAUBENDREHER - SET 6 TLG.



**x6 S2 SOFT TOUCH**

- Bits made from CrV steel, quenched
- Two-component non-slip handles SOFT TOUCH • Magnetic bit tips
- $\varnothing$  1.4x50 mm, 2.0x50 mm, 2.5x75 mm  $\varnothing$  000x50 mm, 00x75 mm, 0x75 mm

Code	Quantity (pcs.)		
10998	6	x	10/30

**1 MULTIFUNCTION SCREWDRIVER**

- УНИВЕРСАЛЬНАЯ ОТВЕРТКА
- MULTIFUNKTIONSSCHRAUBENDREHER



- Telescopic magnetic catcher
- 25 mm ⌀ PH 1 i PH2, ⌀ PZ 1, 2 ⌀ 5, 6 mm
- Non-slip rubber handle

Code	Quantity (pcs.)		
10014	6	x	100

**2 BIT AND SOCKET SET - 52 PCS.**

- УНИВЕРСАЛЬНАЯ ОТВЕРТКА С НАБОРОМ ТОРЦЕВЫХ ГОЛОВКИ И БИТОВ - 52 ШТ.
- SCHRAUBENDREHER MIT BITS UND EINSÄTZEN - 52 STK.



CrV

- The set includes:
- 1/4" ⌀ 6, 7, 8, 9, 10, 11, 12 mm, 3/16", 1/4", 5/16", 11/32", 3/8", 7/16", 1/2"
- 25 mm ⌀ PH 0, 1, 2, 3 ⌀ PZ 0, 1, 2, 3 ⌀ 3, 4, 5, 6 mm ⌀ TORX T10, T15, T20, T25, T30, T40 • 50 mm ⌀ PH 2, 3 ⌀ PZ 1, 2 ⌀ 6 mm ⌀ TORX T15, T20 ⌀ 1.5; 2; 2.5; 3; 4; 5; 5.5; 6 mm ⌀ S1, S2, S3 • ⌀

Code	Quantity (pcs.)		
10055	52	x	6/24

**3 40 PCS CREWDRIVER SOCKET SET**

- ОТВЕРТКА С ХРАПОВЫМ МЕХАНИЗМОМ НАБОР 40 ШТ.
- 40-TEILIGES STECKSCHLÜSSEL-SET



- Rubber handle with a joint and 3-position ratchet • Socket connector - 1 pcs.
- 1/4" ⌀ 6, 7, 8, 9, 10, 11, 12 mm, 3/16", 1/4", 5/16", 11/32", 3/8", 7/16", 1/2" • 1/4" ⌀ PZ1, PZ2 ⌀ PH1, PH2, PH3 ⌀ SL5, SL6, SL7 ⌀ SL5, SL6, SL7, SQ1, SQ2, SQ3 ⌀ T10, T15, T20, T25, T27, T30, T40 ⌀ H1.5, H2, H2.5, H3, H4, H5, H5.5, H6
- Delivered in a plastic box and cardboard packaging

Code	Quantity (pcs.)	
10013	40	24

**4 SCREWDRIVER AND CAR ELECTRIC CIRCUIT TESTER**

- АВТОМОБИЛЬНАЯ ОТВЕРТКА ТЕСТЕР 6-24В • SCHRAUBENDREHER UND KFZ-STROMKREISTESTER



- Live wire detection • Open circuit detection
- Testing fuses

Code	Measuring range		
10583	6 - 24 V	x	50/200

**5 COMBINATION PLIERS**

- УНИВЕРСАЛЬНЫЕ ПЛОСКОГУБЦЫ • КОМБИЗАНГЕ



- Forged • Quenched • American type
- Ergonomic PVC covers

Code	Size (mm)	
28660	160	6/60
28661	180	6/60
28662	200	6/60

**6 DIAGONAL SIDE CUTTERS**

- БОКОРЕЗЫ • SEITENSCHNEIDER



- Forged • Quenched • American type
- Ergonomic PVC covers

Code	Size (mm)	
28670	160	6/60
28671	180	6/60
28672	200	6/60

**7 SNIPE NOSE PLIERS, BENT**

- ПОЛУКРУГЛЫЕ ВЫГНУТЫЕ ПЛОСКОГУБЦЫ (ТОНКОГУБЦЫ)
- HALBRUNDZANGE ABGEWINKELT



- Forged • Quenched • American type
- Ergonomic PVC covers

Code	Size (mm)	
28691	160	6/60
28693	200	6/60

**8 SNIPE NOSE PLIERS**

- УНИВЕРСАЛЬНЫЕ ПРЯМЫЕ ПЛОСКОГУБЦЫ (ТОНКОГУБЦЫ)
- HALBRUNDZANGE GRADE



- Forged • Quenched • American type
- Ergonomic PVC covers

Code	Size (mm)	
28681	160	6/60
28683	200	6/60

**9 CIRCLIP PLIERS**

- ЩИПЦЫ ДЛЯ СТОПОРНЫХ КОЛЕЦ
- SICHERUNGSRINGZANGE FÜR INNENRINGE



Code	Size (mm)	Type	Kind	
28436	150	ext.	curved	10/100
28446	200	ext.	curved	10/100
28438	150	int.	curved	10/100
28448	200	int.	curved	10/100
28456	150	ext.	straight	10/100
28466	200	ext.	straight	10/100
28458	150	int.	straight	10/100
28468	200	int.	straight	10/100



**1 5PC. CIRCLIP PLIER SET**

- НАБОР ЩИПЦОВ ДЛЯ СТОПОРНЫХ КОЛЕЦ – 5ШТ.
- SICHERUNGSRINGZANGE FÜR INNENRINGE



- Set of 5
- PVC coated handles plus 4 replaceable bits for external and internal circlips (two straight, two bent 90°)



Code	Size (mm)		
28650	150	x	10/60

**4 AUTOMATIC WIRE STRIPPER**

- А ВТОМАТИЧЕСКИЙ МНОГОФУНКЦИОНАЛЬНЫЙ СТРИППЕР
- AUTOMATISCHE ABISOLIERZANGE



- Adjustable jaws to remove insulation from wires with profile 0.5 - 6 mm<sup>2</sup>
- Quenched cutting blade fro wires
- Jaws for tip clamping

Code	Cross section of the conductor		
28426	0.5 - 6 mm <sup>2</sup>	x	10/60

**7 SELF-GRIP PLIERS**

- КЛЕЩИ САНТЕХНИЧЕСКИЕ MORSE 'A'
- GRIPZANGE



- Rounded jaws • Adjustable gripping force
- Nickel-plated
- The self-grip pliers are designed for gripping rounded objects, for welding and plumbing works



Code	Size (mm)	
28218	180	6/60
28225	250	6/48

**2 AUTOMATIC WIRE STRIPPER**

- А ВТОМАТИЧЕСКИЕ КЛЕЩИ-ЩИПЦЫ ДЛЯ СНЯТИЯ ИЗОЛЯЦИИ
- AUTOMATISCHE ABISOLIERZANGE



- Adjustable jaws to remove insulation from wires with profile 0.5 - 6 mm<sup>2</sup>
- Blade for wire insulation cutting

Code	Cross section of the conductor		
28400	0.5 - 6 mm <sup>2</sup>	x	25/100

**5 CRIMPING PLIERS**

- А ВТОМАТИЧЕСКИЙ МНОГОФУНКЦИОНАЛЬНЫЙ СТРИППЕР
- UNIVERSALE CRIMPZANGE

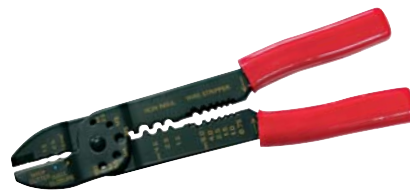

- Removing insulation from wires with profile 0.75 - 6.0 mm<sup>2</sup> • PVC covers • Crimping insulated tips 1.5 - 4.5 mm i 1.5 - 6 mm

Code	Size (mm)		
28428	230	x	12/72

**8 C-TYPE LOCKING WRENCH**

- ЗАЖИМНЫЕ КЛЕЩИ ТИПА „С”
- CRIMPZANGE TYP C



- Adjustable gripping force and opening release lever • Nickel-plated

Code	Size (mm)	
28230	280	36

**3 WIRE STRIPPER**

- ЩИПЦЫ ДЛЯ СНЯТИЯ ИЗОЛЯЦИИ
- UNIVERSALE CRIMPZANGE



- Wire stripper to remove insulation from wires with profile 0.5 - 5 mm<sup>2</sup>
- Adjustable wire size

Code	Cross section of the conductor		
28410	0.5 - 5 mm <sup>2</sup>	x	10/60

**6 WATERPUMP PLIERS**

- КЛЕЩИ САНТЕХНИЧЕСКИЕ
- ROHRZANGE



- Chromium-plated • PVC-coated handles

Code	Size (mm)	
28210	250	6/60

**9 W-TYPE LOCKING WRENCH**

- ЗАЖИМНЫЕ КЛЕЩИ ТИПА „W”
- CRIMPZANGE TYP W



- Adjustable gripping force release and opening lever • Nickel-plated

Code	Size (mm)	
28232	225	30

PROLINE

LANIT PRO

MEGA

JUCO

OTHER BRANDS

ERDI

KLINGSPOR

EXPRESS

ACTION CAN

TRYTON

VULCAN

**1 MULTIFUNCTION PLIERS**

- МНОГОФУНКЦИОНАЛЬНЫЕ ПЛОСКОГУБЦЫ (МУЛЬТИТУЛ)
- TASCHENMULTIFUNKTIONSZANGE



- 15 tools in one:
- Multifunction extendable flat pliers, wire cutter; hook pusher; fish scraper; file, gauge, slotted screwdrivers - 3 pcs., Phillips screwdriver; tin opener; 2 knife blades, bottle opener • Foldable structure enables to hold the whole tool in a pocket case

Code	Size (mm)		
28023	160	x	10/40

**2 RETRACTABLE KNIFE**

- УНИВЕРСАЛЬНЫЙ НОЖ С ВЫДВИЖНЫМ ЛЕЗВИЕМ
- MESSER MIT ABBRECHKLINGE



- Retractable, broken blade
- Metal guide
- Plastic body with precise blade lock

Code	Blade (mm)	Length (mm)		
30058	18	150	x	12/240

**3 RETRACTABLE KNIFE**

- УНИВЕРСАЛЬНЫЙ НОЖ С ВЫДВИЖНЫМ ЛЕЗВИЕМ
- MESSER MIT ABBRECHKLINGE



- Retractable, broken blade
- Metal guide
- Plastic body with blade lock

Code	Blade (mm)	Length (mm)		
30048	18	150	x	24/240

**4 RETRACTABLE KNIFE**

- УНИВЕРСАЛЬНЫЙ НОЖ С ВЫДВИЖНЫМ ЛЕЗВИЕМ
- MESSER MIT ABBRECHKLINGE



- Retractable blade • Length 150 mm
- Plastic body with blade lock
- Delivered in a plastic bag

Code	Blade (mm)	Length (mm)		
30018H	18	150	x	50/500

**5 RETRACTABLE KNIFE**

- УНИВЕРСАЛЬНЫЙ НОЖ С ВЫДВИЖНЫМ ЛЕЗВИЕМ
- MESSER MIT ABBRECHKLINGE



- Retractable, broken blade
- Plastic body with blade lock

Code	Blade (mm)	Length (mm)		
30009H	9	130	x	100/1000

**6 RETRACTABLE KNIFE**

- УНИВЕРСАЛЬНЫЙ НОЖ С ВЫДВИЖНЫМ ЛЕЗВИЕМ
- MESSER MIT ABBRECHKLINGE



- Retractable, broken blade
- Plastic body with blade lock

Code	Blade (mm)	Length (mm)		
30069	9	130	x	48/960
30068	18	150	x	24/480

**7 RETRACTABLE KNIFE AND BLADES SET**

- УНИВЕРСАЛЬНЫЙ НОЖ С ВЫДВИЖНЫМ ЛЕЗВИЕМ
- MESSER MIT ABBRECHKLINGE



- Retractable blade
- Plastic body with blade lock
- Delivered with 10 spare blades in a box

Code	Blade (mm)	Length (mm)		
30019	18	150	x	20/100

**8 RETRACTABLE KNIFE SET**

- НАБОР УНИВЕРСАЛЬНЫХ НОЖЕЙ С ВЫДВИЖНЫМ ЛЕЗВИЕМ
- TAPETENMESSERSATZ



- 3 pcs.: 9 mm - 130 mm narrow, 9 mm - 130 mm wide, 18 mm - 150 mm
- Retractable blades
- Plastic bodies with blade lock

Code	Quantity (pcs.)		
30203	3	x	12/120

**9 RETRACTABLE KNIFE SET**

- НАБОР УНИВЕРСАЛЬНЫХ НОЖЕЙ И СКРЕБКОВ С ВЫДВИЖНЫМ ЛЕЗВИЕМ • MESSERSATZ



Code	Quantity (pcs.)		
30008	8	x	50/100

**10 GLASS SCRAPER**

- СКРЕБОК ДЛЯ ОЧИСТКИ СТЕКОЛ
- GLASSCHABER



Code	Blade (mm)	
31000	60	24/288

## 1 MODELLER'S KNIFE KIT

• НАБОР МОДЕЛЬНЫХ НОЖЕЙ • MESSERSATZ MIT KLINGEN



- Set of 3 handles - 8 and 11 mm and 11 mm with a plastic cover, with 13 replaceable blades of different shapes for different kinds of works: modelling, woodworking etc.
- Delivered in a box

Code	Quantity (pcs.)		
30216	16	x	40

## 2 SCISSORS

• НОЖИЦЫ • SCHERE



STAINLESS

- Stainless steel • Quenched

Code	Length (mm)		
30086	215	x	30/60



## 3 RETRACTABLE KNIFE BLADES

• СЕГМЕНТНЫЕ ОБЛАМЫВАЕМЫЕ ЛЕЗВИЯ  
• AUSWECHSELBARE ABBRECHKLINGE



- Delivered 10 pcs. in a plastic box

Code	Blade (mm)		
31300	60	x	100/500
31301	60		25/250

## 4 RETRACTABLE KNIFE BLADES

• СЕГМЕНТНЫЕ ОБЛАМЫВАЕМЫЕ ЛЕЗВИЯ  
• AUSWECHSELBARE ABBRECHKLINGE



- Delivered 10 pcs. in a plastic box

Code	Blade (mm)	
31009H	9	20/500
31018H	18	20/300

## 5 MEASURING TAPES

• ИЗМЕРИТЕЛЬНЫЕ РУЛЕТКИ  
• ROLLMASSBÄNDER



- 2nd precision class
- 3 additional rakes, including one from below
- Housing covered with non-slip rubber

Code	Length (m)	Tape (mm)		
20112	2	16		12/120
20113	3	16		12/120
20115	5	19		12/96
20117	7.5	25		6/48
20119	10	32		6/30
20112K	2	16	x	12/120
20113K	3	16	x	12/120
20115K	5	19	x	12/96
20117K	7.5	25	x	6/48
20119K	10	32	x	6/30

## 6 MEASURING TAPES

• ИЗМЕРИТЕЛЬНЫЕ РУЛЕТКИ • ROLLMASSBÄNDER



- Colourful plastic casing • Brake

Code	Length (m)	Tape (mm)	
20102	2	13	12/120
20103	3	13	12/120
20203	3	16	12/120
20105	5	13	12/120
20205	5	16	12/120
20206	5	19	12/120

## 7 LONG STEEL MEASURING TAPES

• ИЗМЕРИТЕЛЬНЫЕ ДЛИННЫЕ СТАЛЬНЫЕ РУЛЕТКИ  
• MASSBÄNDER LANG AUS STAHL



- Steel tape
- Delivered in a fancy cardboard box

Code	Length (m)	
20331	10	50
20332	20	50
20333	30	50
20335	50	30

## 8 LONG GLASS-FIBRE MEASURING TAPES

• ИЗМЕРИТЕЛЬНЫЕ ДЛИННЫЕ РУЛЕТКИ ИЗ СТЕКЛОВОЛОКНА  
• MASSBÄNDER LANG AUS GLASFASER



- Fibre glass tape
- Delivered in a fancy cardboard box

Code	Length (m)	
20311	10	60
20312	20	60
20313	30	50
20315	50	30

PROLINE

LANTTI PRO

MEGA

JUCO

OTHER BRANDS

ERDI

KLINGSPOR

EXPRESS

ACTION CAN

TRAYTON

VULCAN

**1 RETRACTABLE MEASURE - KEYCHAIN**

- РУЛЕТКА-БРЕЛОК
- ROLLMASSBÄNDER SCHLÜSSELANHÄNGER



- Keychain – miniature of the car tire

Code	Length (m)	
20101	1	100/1000

**2 LONG STEEL MEASURING TAPES**

- ГЕОДЕЗИЙНЫЕ ДЛИННЫЕ СТАЛЬНЫЕ РУЛЕТКИ
- MASSBÄNDER LANG AUS STAHL



- Steel tape
- Delivered in a fancy cardboard box

Code	Length (m)	
20342	20	10
20343	30	10
20345	50	10

**3 HARDWOOD FOLDING RULERS**

- ДЕРЕВЯННЫЕ СКЛАДНЫЕ ЛИНЕЙКИ
- HOLZZOLLSTÖCKE



- Wooden

Code	Length (m)	Type	
13001	1	5-częściowa	24/480
13002	2	10-częściowa	12/240

**4 RIGID STEEL GAUGE**

- СТАЛЬНЫЕ ЛИНЕЙКИ
- STAHLMASS STEIF



- Two-sided graduation on both edges
- Stainless steel

Code	Size (mm)	
22015	150 x 18	10/600
22030	330 x 28	10/360

**5 COMBINATION SQUARES**

- УГЛОМЕР РАЗВОДНОЙ - WINKEL MIT SKALA

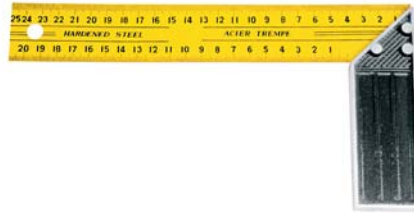

Code	Length (mm)	
21125	250	12/120
21130	300	12/120
21135	350	12/120

**6 PROFESSIONAL SPIRIT LEVELS 2 VIALS**

- СПИРТОВЫЕ УРОВНИ
- WASSERWAAGEN – 2 LIBELLEN, PROFESSIONELL



**AL**

- Accuracy 1 mm / 1 m
- Two-sided graduation • Aluminium box body
- 2 level vials: horizontal and vertical

Code	Length (mm)	
15034	400	60
15036	600	60
15038	800	60
15040	1000	60
15042	1200	30
15045	1500	30
15050	2000	30

**7 SPIRIT LEVELS - 3 VIALS WITH HAND HOLDERS**

- СПИРТОВЫЕ УРОВНИ
- WASSERWAAGEN - 3 LIBELLEN MIT HANDGRIF



**AL**

- Accuracy 1 mm / 1 m • Aluminium box body with a hand holder • 3 level vials: horizontal, vertical and at 45° angle

Code	Length (mm)	
15176	600	50
15178	800	50
15180	1000	20
15182	1200	20
15185	1500	20
15190	2000	20

**8 DIGITAL CALIPER**

- ЭЛЕКТРОННЫЙ ШТАНГЕНЦИРКУЛЬ - ELEKTROMESSSCHIEBER



**CE** **STAINLESS**

- Made from stainless steel

Code	Length (mm)	Accuracy (mm)	
20513	150	0.02	10/50

**9 VERNIER CALIPER**

- ШТАНГЕНЦИРКУЛЬ - MESSSCHIEBER



**CARBON** **STAINLESS**

- 20510 - made from stainless steel
- 20511 - made from carbon steel

Code	Length (mm)	Accuracy (mm)	
20510	150	0.02	10/100
20511	150	0.02	10/50

**10 DIAL CALIPER**

- ШТАНГЕНЦИРКУЛЬ С ИНДИКАТОРОМ ЧАСОВОГО ТИПА
- UHRMESSSCHIEBER

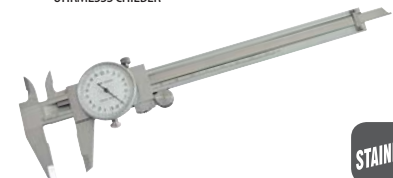

**STAINLESS**

- Made from stainless steel

Code	Length (mm)	Dokładność (mm)	
20512	150	0.02	10/50

**11 FEELER GAUGE**

- ИЗМЕРИТЕЛЬНЫЙ ЩУП - FÜHLERLEHRE



- 0.05 – 1.00 mm every 0.05 mm
- 20 blades

Code	Range (mm)	Accuracy (mm)	
20501	0.05 - 1.00	100	10/100

### 1 TORPEDO LEVELS

- СПИРТОВЫЕ УРОВНИ TORPEDO
- WASSERWAAGEN TORPEDO



- ABS body
- Magnetic base 3 level vials: horizontal, vertical and at 45°

Code	Length (mm)	
15100	152	100
15102	225	100

### 2 LINE LEVEL

- ПОДВЕСНОЙ УРОВЕНЬ
- SCHNURWASSERWAAGE



- Plastic body
- To be hung on ropes

Code	Length (mm)		
15000	70	x	500

### 4 ROTARY LASER LEVEL

- ЛАЗЕРНЫЙ НИВЕЛИР-УРОВЕНЬ
- LASERWASSERWAAGE



- Accuracy  $0.029^{\circ}=0.5$  mm/m • Output power 1 mW • Wavelength  $\lambda=650$  nm
- Batteries 2x1,5V • The set includes: laser level 400mm, levelling components, 2 lenses - linear and 90°, batteries - 2 pcs.

Code	Length (m)		
15124	400	x	24

### 3 ROTARY LASER LEVEL

- ЛАЗЕРНЫЙ ВРАЩАЮЩИЙСЯ НИВЕЛИР-УРОВЕНЬ
- LASERWASSERWAAGE - DREHBAR • LAZERINIS GULŠČIUKAS – ROTACINIS

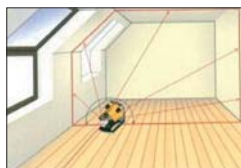

- Accuracy  $0.029^{\circ}=0.5$  mm/m
- Output power  $\leq 1.4$  mW • Wavelength  $\lambda=650$  nm
- 360° rotation with speed control 0-600 min-1
- Setting horizontally and vertically • Batteries 4x1.5 V
- The set includes: rotary laser level, large aluminium stand 45 - 120 cm, batteries - 4 pcs., plastic case

Code	Typ	
15150	obrotowa	4

### 5 LASER LEVEL

- ЛАЗЕРНЫЙ НИВЕЛИР-УРОВЕНЬ
- LASER-WASSERWAAGE



- Accuracy  $0.029^{\circ}=0.5$  mm/m • Output power  $\leq 1$  mW • Wavelength  $\lambda=650$  nm • Batteries 2xAAA • The set includes: laser level 400mm, large aluminium stand 45 - 120 cm, rotary aluminium support with a ground base and level vial, 2 lenses: linear and 90°, batteries - 2 pcs., plastic case

Code	Length (mm)	
15145	400	4

### 1 LASER LEVEL

- ЛАЗЕРНЫЙ НИВЕЛИР-УРОВЕНЬ
- LASER-WASSERWAAGE



- Accuracy 0.029°=0.5 mm/m • Output power ≤ 1 mW • Wavelength λ= 650 nm
- Batteries 2xAAA • The set includes: laser level 400mm, aluminium stand 45 - 100 cm, rotary plastic support with level vial, 2 lenses: linear and 90°, batteries - 2 pcs., plastic case

Code	Length (mm)	
15142	400	4

### 2 RUBBER SANDING BLOCK FOR PAPER AND SCREEN PADS

- РЕЗИНОВЫЙ БРУСОК-ДЕРЖАТЕЛЬ ДЛЯ АБРАЗИВНОЙ БУМАГИ
- GUMMIBLOCK FÜR SCHLEIFPAPIER UND SCHLEIFNETZE



- With rubber face • Snap-on handles

Code	Size (mm)	
45181	125 x 69	12/72

### 3 PLASTIC FLOATS FOR PAPER AND SCREEN PADS

- ПЛАСТИКОВЫЙ БРУСОК-ДЕРЖАТЕЛЬ ДЛЯ АБРАЗИВНОЙ БУМАГИ
- PLATIKBLÖCKE FÜR SCHLEIFPAPIER UND SCHLEIFNETZE



- With rubber face • Snap-on handles

Code	Size (mm)	
45180	212 x 105	20/80

### 4 PUTTY KNIVES

- ШПАТЕЛЯ
- SPACHTELN



- Polished • Plastic handle

Code	Size (mm)	
31134	40	12/240
31136	60	12/240
31138	80	12/240
31140	100	12/240
31143	125	12/240
31145	150	12/240

### 5 BUILDER'S LINE

- ТРАССИРОВОЧНЫЙ ШНУР
- SCHLAGSCHNUR



- Aluminium casing

Code	Length (m)		
38004	15	x	10/100

### 6 PLUMB BOB

- ОТВЕС КАМЕНЩИКА
- LOT



- Delivered with 5 m line

Kód	Weight (g)		
38010	250	x	6/60

### 7 CARPENTER'S PENCIL

- СТОЛЯРНЫЙ КАРАНДАШ
- SCHREINERBLEISTIFT

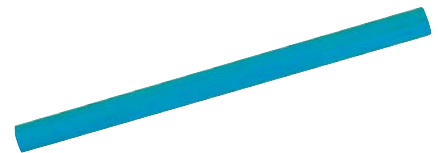

- Sold in packages of 12 pieces

Code	Number in the packaging	
38001K	12	30/240

### 8 INSULATION TAPES

- ИЗОЛЯЦИОННЫЕ КЛЕЮЩИЕ ЛЕНТЫ
- ISOLIERBÄNDER



RUBBER

1kV

- Sets of 3, 6 or 10 discs

Code	Width x Thickness x Length (mm x mm x m)	Quantity in the set (pcs.)	
13123	19 x 0.13 x 3	3	200
13126	19 x 0.13 x 3	6	100
13129	19 x 0.13 x 10	10	10/50

### 9 INSULATION TAPE

- ИЗОЛЯЦИОННАЯ КЛЕЮЩАЯ ЛЕНТА
- ISOLIERBAND



RUBBER

1kV

- Sold individually
- 10 pieces in a sealed package

Code	Width x Thickness x Length (mm x mm x m)	
13121	19 x 0.13 x 10	250/500

### 1 TILE CUTTERS WITH HOLE CUTTER

- РУЧНЫЕ ПЛИТКОРЕЗЫ С БАЛЕРИНКОЙ
- GERÄTE ZUM SCHNEIDEN VON FLIESEN MIT EINEM KNABBER

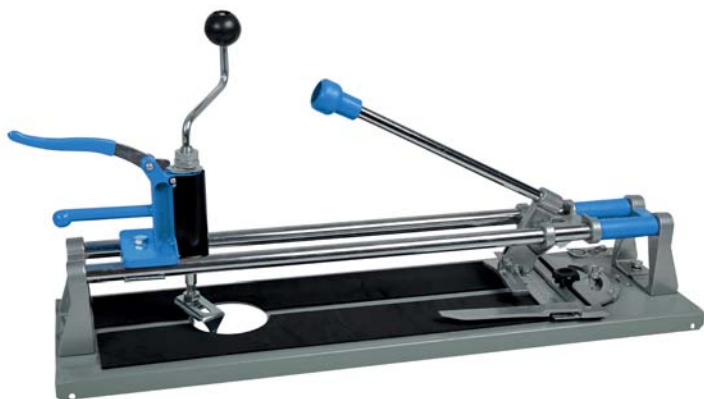

- Steel base
- Enables straight line cutting and breaking 0 - 45° and hole cutting 30 - 80 mm
- PTFE pads on the guides

Code	Size (mm)	Width of the Base (mm)	
75449	435	200	2
75460	600	200	1

### 2 TILE CUTTERS

- РУЧНЫЕ ПЛИТКОРЕЗЫ
- GERÄTE ZUM SCHNEIDEN VON FLIESEN



Code	Size (mm)	Width of the Base (mm)	
75030	300	140	6
75040	400	140	6

### 3 REPLACEMENT WHEELS FOR TILE CUTTER

- РОЛИКИ ДЛЯ РУЧНОГО ПЛИТКОРЕЗА
- ERSATZRÄDER FÜR FLIESENSCHNEIDER



- Hole diameter 6mm

Code	Size (mm)	Thickness (mm)	
75762	16	2	250
75763	16	3	250
75722	22	2	250

### 4 TILE HOLE CUTTER WITH A GUARD

- СВЕРЛО ПО КЕРАМИКЕ
- KNABBER FÜR BOHRUNGEN IN FLIESEN



Code	Diameter (mm)	
75772	20 - 94	10

### 5 TILE CUTTING PLIERS

- КУСАЧКИ - ПЛИТКОРЕЗ
- FLIESENSCHNEIDZANGE



- For cutting glass and tiles
- Carbide wheel for initial surface cutting
- Precise breaking of tile or glass with pliers

Code	Size (mm)	
75000	200	10/60

PROLINE

LANIT PRO

MEGA

JUCO

OTHER BRANDS

ERDI

KLINGSPOR

EXPRESS

ACTION GUN

TRAYTON

VULCAN

**1 TILE SPACERS**

- КРЕСТИКИ ДЛЯ УКЛАДКИ КАФЕЛЯ
- FLIESENKEILE



- Packaged in a plastic bag with a cardboard pendant

Code	Size (mm)	No. of pieces in the packaging (pcs.)	
61359	1.0	200	50
61360	1.5	200	50
61361	2.0	200	50
61362	2.5	200	50
61363	3.0	150	50
61364	4.0	100	50
61365	5.0	100	50
61366	6.0	100	50
61368	8.0	50	50
61369	10.0	40	50
61357	12.0	15	50

**2 TILE SPACERS WITH HOLDER**

- КРЕСТИКИ КИ ДИСТАНЦИОННЫЕ ДЛЯ ГЛАЗУРОВАННОЙ ПЛИТКИ, С ДЕРЖАТЕЛЕМ
- FUGENKREUZ FÜR FLIESEN MIT GRIFF

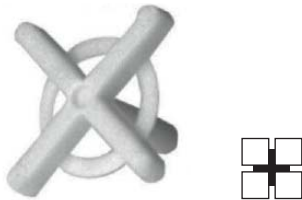

- Packaged in a plastic bag with a cardboard pendant

Code	Size (mm)	No. of pieces in the packaging (pcs.)	
61381	1.5	100	50
61382	2.0	100	50
61383	2.5	75	50
61384	3.0	75	50
61385	4.0	50	50

**3 T-TYPE CLINKER SPACERS**

- КРЕСТИКИ ДЛЯ УКЛАДКИ КЛИНКЕРА
- FUGENKREUZ TYP „T“ FÜR KLINKERSTEINE



- Packaged in a plastic bag with a cardboard pendant

Code	Size (mm)	No. of pieces in the packaging (pcs.)	
61376	1	150	50
61377	2	125	50
61378	3	100	50
61379	4	75	50
61372	5	100	50
61373	8	50	50
61374	10	40	50

**4 TILE WEDGES**

- КЛИНЬЯ ДЛЯ УКЛАДКИ КАФЕЛЯ
- FLIESENKEILE



- Packaged in a plastic bag with a cardboard pendant

Code	Width x Thickness x Length (mm x mm x mm)	No. of pieces in the packaging (pcs.)	
61370	5 x 5 x 22	100	50
61371	10 x 7 x 26	50	50

**5 MAGNETIC TILE HOLDERS**

- МАГНИТНЫЕ ДЕРЖАТЕЛИ ДЛЯ КАФЕЛЯ
- MAGNETGRIFFE FÜR FLIESEN



- For hole concealment with tiles, gypsumboard panels etc.

Code	Set (pcs.)		
61375	4	x	50

**6 FOAM GUN**

- ПИСТОЛЕТ ДЛЯ МОНТАЖНОЙ ПЕНЫ
- SCHAUMPISTOLE



Code	
18018	20

**7 FOAM GUN**

- ПИСТОЛЕТ ДЛЯ МОНТАЖНОЙ ПЕНЫ
- SCHAUMPISTOLE



Code	
18012	20

**8 CAULKING GUN**

- ПИСТОЛЕТ ДЛЯ ВЫДАВЛИВАНИЯ ГЕРМЕТИЧЕСКОЙ МАССЫ
- SKELETTKARTUSCHENPISTOLE

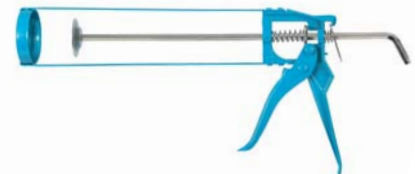

- Metal • Ratchet gear

Code	Size (mm)	
18001	225	40

**9 CYLINDRICAL CAULKING GUN**

- ПИСТОЛЕТ ДЛЯ ВЫДАВЛИВАНИЯ ГЕРМЕТИЧЕСКОЙ МАССЫ
- ZYLINDERKARTUSCHENPISTOLE



- Metal • Ratchet gear

Code	Size (mm)	
18002	225	40

**10 HAND GREASE GUN**

- РУЧНАЯ МАСЛЕНКА
- HANDFETTPRESSE



- Standard with connection thread M10x1
- With a hose and 4-jaw tip
- Delivered in a cardboard box

Code	Size (ml)	
42505	400	10



### 1 MACHINIST'S HAMMERS

- СЛЕСАРНЫЕ МОЛОТКИ
- SCHLOSSERHÄMMER



**DIN 1041** **HRC 51±2**

- Forged and quenched head
- Wooden, varnished handle
- Head fixing reinforced with an adapter sleeve

Code	Weight (g)	☐
12122	200	12/96
12123	300	6/60
12124	400	6/48
12125	500	6/36
12128	800	6/24

### 2 CLAW HAMMER

- МОЛОТОК СТОЛЯРНЫЙ
- SCHREINERHAMMER



Code	Weight (g)	☐
12204	450	6/24

### 3 ROOFING HAMMER

- ПЛОТНИЦКИЙ МОЛОТОК
- ZIMMERMANNSHAMMER



- Heat with a magnetic nail holder

Code	Weight (g)	☐
12206	600	6/24

### 4 ROOFING HAMMER

- ПЛОТНИЦКИЙ МОЛОТОК
- ZIMMERMANNSHAMMER



- Special head with magnetic nail holder
- Metal holder with rubber coat

Code	Weight (g)	☐
12200	600	6/24

### 5 RHENISH MASONRY HAMMER

- МОЛОТОК КАМЕНЩИКА (РЕЙНСКИЙ ТИП)
- MAURERHAMMER - RHEINISCHE FORM



- Rhenish type
- Shank - steel profiled tube
- Rubber handle

Code	Weight (g)	☐
12213	600	10/30

### 6 BERLINER MASONRY HAMMER

- МОЛОТОК КАМЕНЩИКА (БЕРЛИНСКИЙ ТИП)
- MAURERHAMMER - BERLINER FORM



- Rubber handle

Code	Weight (g)	☐
12212	600	6/24

### 7 RUBBER MALLET

- РЕЗИНОВАЯ КИЯНКА
- GUMMIHAMMER



- Rubber slogging head
- Wooden handle

Code	Weight (g)	Head diameter (mm)	☐
12010	1115	90	12

### 8 RUBBER MALLETS

- РЕЗИНОВЫЕ КИЯНКИ
- GUMMIHÄMMER



- Rubber slogging heady
- Shank - steel profiled tube
- Rubber handle

Code	Weight (g)	Head diameter (mm)	☐
12006	450	55	36
12007	680	65	24

### 9 RUBBER MALETS

- РЕЗИНОВЫЕ КИЯНКИ
- KFZ-GUMMIHÄMMER



- Rubber slogging heady
- Shank - steel profiled tube
- Rubber handle

Code	Weight (g)	Head diameter (mm)	☐
12008	225	40	60
12009	450	65	36

### 10 TINMAN'S MALLET

- РЕЗИНОВАЯ КИЯНКА
- KFZ-HAMMER



- Replaceable heads (plastic and rubber)
- Shank - steel profiled tube
- Rubber handle

Code	Head diameter (mm)	☐
12035	35	50

PROLINE

LANITI PRO

MEGA

JUCO

OTHER BRANDS

ERDI

KLINGSPOR

EXPRESS

ACTION CAN

TRAYTON

VULCAN

**1 CROWBAR**

- ГВОЗДОДЕР
- NAGELEISEN



Code	Length (mm)	
31424	600	20

**4 SAND SHOVEL, METAL HANDLE**

- ЛОПАТА ДЛЯ ПЕСКА С МЕТАЛЛИЧЕСКИМ ЧЕРЕНКОМ
- SANDSCHAUFEL, METALLSTIEL



**HRC**  
45±2

- Handle with plastic cover

Code	Dimensions (mm)	
14363	1250 x 278 x 325	6

**2 GARDEN SPADE, METAL HANDLE**

- ШТЫКОВАЯ ПРЯМОУГОЛЬНАЯ ЛОПАТА
- GERADER SPATEN, METALLSTIEL



**HRC**  
45±2

- Handle with plastic cover

Code	Dimensions (mm)	
14361	1150 x 185 x 270	6

**5 10 PCS. NEEDLE FILE SET**

- НАБОР НАДФИЛЕЙ – 10 ШТ.
- FEINFEILE - SET 10 TLG.

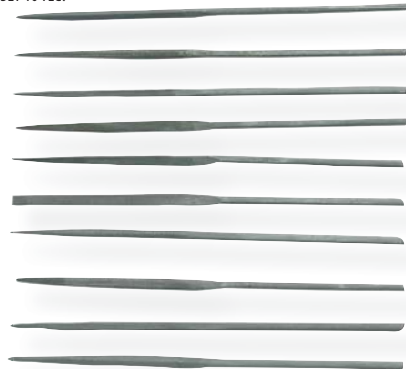

- Length 140 mm • Plastic case • The set includes: flat, flat-convergent, semirounded, triangular, square, round, knife, crossing, slitting

Code	Quantity in the set (pcs.)	
32010	10	50/200

**3 SHARP QUENCHED BLADE, METAL HANDLE**

- ШТЫКОВАЯ ЛОПАТА
- SPITZER SPATEN, METALLSTIEL



**HRC**  
45±2

- Handle with plastic cover

Code	Dimensions (mm)	
14362	1150 x 185 x 270	6

**6 6PC PRECISION FILES - SET**

- НАБОР НАДФИЛЕЙ – 6 ШТ.
- FEINFEILE - SET 6 TLG.



Profiles:

145-150 mm

x6

- 160 mm • Cut no. 2 • Two component handle • Plastic case • The set includes: flat, flat-convergent, semirounded, triangular, square, round

Code	Quantity in the set (pcs.)		
32016	160	x	12/120

### 1 WHETSTONE

- АБРАЗИВНЫЙ БРУСОК
- SCHLEIFSTEIN OVAL



- Fine

Code	Length (mm)	
45001	200	100

### 2 WIRE HAND BRUSH

- МЕТЧИКИ
- HANDGEWINDEBOHRER



- Brass-coated wire
- Plastic handle

Code	
32004	20/120

### 3 ALL-PURPOSE BRUSHES

- УНИВЕРСАЛЬНЫЕ ЩЕТКИ
- UNIVERSALBÜRSTEN



- Bristle: copper, steel, nylon
- Plastic handles

Code	Size	Set (pcs.)		
32018	180	3	x	24/240
32023	230	3	x	30/60

### 4 SCREW EXTRACTOR SET

- ВЫВЕРТКИ ДЛЯ ВИНТОВ
- SCHRAUBENAUSDREHER



- Delivered in plastic box

Code	Range Ø (mm)		
32050	3.3 - 19.0	x	25/100

### 5 HAND TAPS

- МЕТЧИКИ
- HANDGEWINDEBOHRER



- Carbon steel
- Delivered in sets of 3, No. 1, 2, 3

Code	Size	
67003	M3	40/400
67004	M4	40/400
67005	M5	40/400
67006	M6	40/400
67008	M8	20/400
67010	M10	10/200
67012	M12	10/200

### 6 DIES

- ПЛАШКИ
- SCHNEIDEISEN

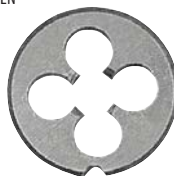

- Carbon steel

Code	Size	External diameter (mm)	
67103	M3	25	20/600
67104	M4	25	20/600
67105	M5	25	20/600
67106	M6	25	20/600
67108	M8	25	20/600
67110	M10	25	20/600
67112	M12	25	20/600

### 7 TAPS AND DIES

#### 24 PCS. SET

- НАБОР МЕТЧИКОВ И ПЛАШЕК - 24 ШТ.
- GEWINDEBOHRER UND SCHNEIDEISEN - SET 24 TLG.



- Carbon steel
- The set includes taps and dies: 5 x 0.8, 5 x 0.9, 6 x 0.75, 6 x 1, 8 x 1, 8 x 1.25, 10 x 1.25, 10 x 1.5, 12 x 1.75, 12 x 2, 1/8 NPT 27 - по 1 pcs.
- Tap wrench - 1 pc., die holder - 1 pc.

Code	Range (mm)	Quantity (pcs.)	
67224	5 - 12	24	20

### 8 TAP WRENCH

- ВОРОТОК ДЛЯ МЕТЧИКА
- KNEBELGRIFF FÜR GEWINDEBOHRER



Code	For taps		
67000	M3 - M12	x	50/100

### 9 DIE HOLDER

- ВОРОТОК ДЛЯ ПЛАШЕК
- SCHNEIDEISENHALTER



- For dies with external dia. 25 mm

Code	Size		
67100	M3 - M12	x	50

### 10 THREADING SET

- НАБОР ВИНТОНАРЕЗНЫХ ГОЛОВОК ДЛЯ ТРУБ
- GEWINDEBOHRER-SET



- The set includes: threaders dia. 3/8", 1/2", 3/4", 1", 1 1/4", ratchet, handle, extender

Code	Diameter	
67205	3/8" - 1 1/4"	4

PROLINE

LANTTI PRO

MEGA

JUCO

OTHER BRANDS

ERDI

KLINGSPOR

EXPRESS

ACTION CAN

TRYTON

VULCAN

**1 HOBBY VICE**

• ТИСКИ ДЛЯ МОДЕЛИРОВАНИЯ • HOBBY-SCHRAUBSTOCK



• Cast iron vice with anvil and rotating base

Code	Size (mm)	
25325	25	50
25340	40	50
25360	60	20

**2 BOLT CUTTERS**

• НОЖИЦЫ ДЛЯ ПРУТКОВ • BOLZENSCHNEIDER



• Adjustable gripping force

Code	Size (mm)	Ø max. (mm)	
17045	450	8	20
17060	600	10	10
17075	750	13	5

**3 STRAIGHT TINMAN'S SNIPS**

• ЛИСТОВЫЕ ПРЯМЫЕ НОЖИЦЫ • BLECHSCHERE GERADE



Code	Size (mm)	
17001	250	10/40

**4 AVIATION SNIPS**

• НОЖИЦЫ ПО МЕТАЛЛУ ШАРНИРНЫЕ  
• GELENKSCHERE



Code	Size (mm)	Type		
17011	250	straight	x	6 / 48
17012	250	right	x	6 / 48
17013	250	left	x	6 / 48



**5 HACKSAW FRAME**

• НОЖОВКА ПО МЕТАЛЛУ • METALLBÜGELSÄGE



• Made from a rectangular profile, coated  
• Plastic handle

Code	Size (mm)	
23102	300	48

**6 MINI HACKSAW FRAME**

• МИНИНОЖОВКА ПО МЕТАЛЛУ  
• MINI-METALLBÜGELSÄGE



• Plastic handle

Code	Size (mm)	
23005	150	50/200

**1 MINI HACKSAW FRAME**

- МИНИНОЖОВКА ПО МЕТАЛЛУ
- MINI -METALLBÜGELSÄGE



- Plastic handle

Code	Size (mm)		
23000	150	x	20/300

**4 BOW SAWS**

- ЛУЧКОВЫЕ ПИЛЫ
- BÜGELSÄGEN



- For wood cutting

Code	Size (mm)	
64160	600	24

**7 SPRING CLAMPS**

- ПРУЖИННЫЕ ЗАЖИМЫ
- FEDERKLEMMEN



- Made from nylon and glass fibre
- Quenched pressure spring
- Heavy and quick clamping

Code	Size (mm)	
11000	110	10/100
11001	165	20/120
11002	225	72

**2 HACKSAW BLADES**

- НОЖОВОЧНЫЕ ПОЛОТНА ПО МЕТАЛЛУ
- METALLSÄGEBLATT

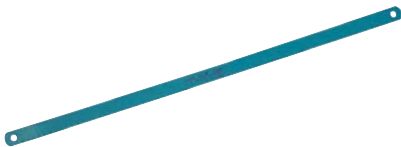

- One-sided • Carbon steel • Coated
- Delivered in the box of 72 pcs.

Code	Size (mm)	Quantity (pcs.)	
23018L	300 x 12.5	72	20

**3 HACKSAW BLADES**

- НОЖОВОЧНЫЕ ПОЛОТНА ПО МЕТАЛЛУ
- METALLSÄGEBLATT

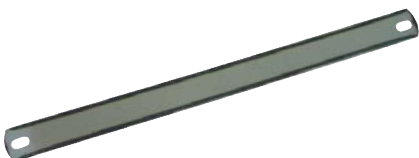

- Two-sided • Carbon steel
- Delivered in the box of 36 pcs.

Code	Size (mm)	Quantity (pcs.)	
23118K	300 x 25	36	2/20

**5 MITRE BOX**

- ПЛАСТИКОВОЕ СТУСЛО С НОЖОВКОЙ
- GEHRUNGSLADE HÖLZERN



- For cutting at the angles 45° and 90° • Measuring scale with mitre saw 300 mm long

Code	Length (mm)	Max. width of cut strips (mm)	
23300	300	65	50

**6 MITRE SAW**

- УГЛОТОРЦОВОЧНАЯ НАСТОЛЬНАЯ ПИЛА
- GEHRUNGSSÄGE



- Saw for cutting at different angles up to 45°
- Blade 550 mm • Adjustable cutting depth
- Clamps for the cut material • Angular scale on a base
- Max. cutting width for 45° - 115 mm, 90° - 125 mm with clamping, 170 mm without clamping
- Max cutting height - 100 mm

Code	Blade length (mm)		
64000	550	x	4

**1 F-TYPE QUICK ACTION CLAMPS**

- СТОЛЯРНЫЕ СТРУБИНЫ
- ZWINGE TYP F

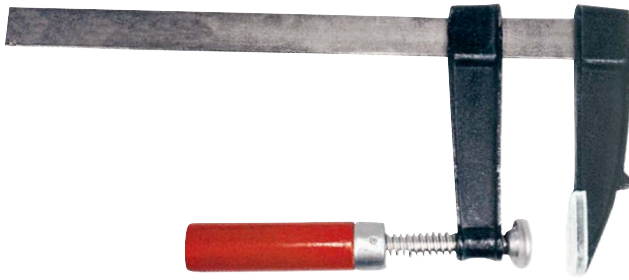

- Fast sliding • Wooden handle

Code	Size (mm)		Code	Size (mm)	
11010	100 x 50	50	11031	300 x 120	10
11015	150 x 50	50	11051	500 x 120	10
11020	200 x 50	50	11081	800 x 120	10
11025	250 x 50	50	11101	1000 x 120	10
11030	300 x 50	50	11121	1200 x 120	10

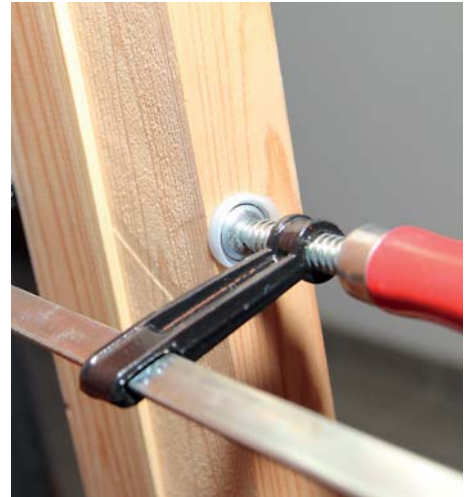

**2 WOOD CHISELS**

- НАБОР СТАМЕСОК
- HOLZMEISSEL



- Plastic handles
- Truncated side edges
- Delivered in plastic case

Code	Widths (mm)	
19004	6, 12, 18, 24	40

**3 WOOD CHISELS**

- СТАМЕСКИ
- HOLZMEISSEL



- Plastic handles
- Truncated side edges
- Delivered in plastic case

Code	Width (mm)	
19006	6	12/120
19008	8	12/120
19010	10	12/120
19012	12	12/120
19014	14	12/120
19015	15	12/120
19016	16	12/120
19018	18	12/120
19020	20	12/120
19022	22	12/120
19025	25	12/120
19032	32	12/120
19038	38	12/120

**4 HSS METAL DRILLS**

- СВЕРЛА
- METALLBOHRER HSS



**HSS**

- Delivered in a metal box

Code	Range (mm)	Quantity (pcs.) in the set	
26219	1-10 co 0.5	19	40

**6 HSS TWIST DRILL SETS**

- НАБОРЫ СВЕРЕЛ ПО МЕТАЛЛУ ИЗ БЫСТРОРЕЖУЩЕЙ СТАЛИ HSS - METALLBOHRER - SET



**HSS**

- Delivered in plastic box

Code	Range (mm)	Quantity (pcs.) in the set	
26313	1.5-6.5 po 0.5 + 3.2, 4.8	13	100
26213	2.0-8.0 po 0.5	13	10/60

**5 HSS TIN METAL DRILLS**

- НАБОР СВЕРЕЛ ПО МЕТАЛЛУ ИЗ БЫСТРОРЕЖУЩЕЙ СТАЛИ HSS - 19 ШТ.
- METALLBOHRER HSS TIN



**HSS TiN**

- HSS coated with titanium nitride
- Delivered in a metal box

Code	Range (mm)	Quantity (pcs.) in the set	
26719	1-10 po 0.5	19	20

### 1 SDS PLUS CONCRETE DRILLS

- СВЕРЛА ПО БЕТОНУ SDS PLUS
- BETONBOHRER SDS PLUS



**SDS plus**

- Tungsten carbide tipped (TCT) edge with enlarged centering tip that allows drilling without walking
- Quick removal of cuttings from the hole
- For use in non-reinforced concrete, natural stone, brick, masonry walls
- Supplied individually in hanging packaging

Code	Diameter (mm)	Total length (mm)		Code	Diameter (mm)	Total length (mm)	
80411	4	110	25/250	81460	14	600	20/40
80416	4	160	25/200	81616	16	160	20/80
80511	5	110	25/250	81621	16	210	20/80
80516	5	160	25/200	81626	16	260	20/80
80611	6	110	25/250	81630	16	300	20/80
80616	6	160	25/200	81635	16	350	20/40
80621	6	210	25/100	81640	16	400	20/40
80626	6	260	25/100	81645	16	450	20/40
80811	8	110	25/250	81660	16	600	20/40
80816	8	160	25/200	81680	16	800	20/40
80821	8	210	25/100	81821	18	210	10/20
80826	8	260	25/100	81826	18	260	10/20
80830	8	300	25/100	81835	18	850	10/20
80835	8	350	25/100	81840	18	400	10/20
80840	8	400	25/100	81845	18	450	10/20
80845	8	450	25/100	81860	18	600	10/20
81011	10	110	25/250	82021	20	210	10/20
81016	10	160	25/200	82026	20	260	10/20
81021	10	210	25/100	82030	20	300	10/20
81026	10	260	25/100	82040	20	400	10/20
81030	10	300	25/100	82045	20	450	10/20
81035	10	350	25/100	82060	20	600	10/20
81040	10	400	25/100	82080	20	800	10/20
81045	10	450	25/100	82221	22	210	10/20
81060	10	600	20/40	82226	22	260	10/20
81211	12	110	25/250	82230	22	300	10/20
81216	12	160	25/200	82240	22	400	10/20
81221	12	210	25/100	82245	22	450	10/20
81226	12	260	25/100	82260	22	600	10/20
81230	12	300	25/100	82280	22	800	10/20
81235	12	350	25/100	82426	24	260	10/20
81240	12	400	25/100	82440	24	400	10/20
81245	12	450	25/100	82460	24	600	10/20
81260	12	600	20/40	82480	24	800	10/20
81280	12	800	20/40	82530	25	300	10/20
81316	13	160	25/200	82545	25	450	10/20
81326	13	260	25/100	82560	25	600	10/20
81335	13	450	25/100	82626	26	260	10/20
81416	14	160	25/100	82640	26	400	10/20
81421	14	210	25/100	82660	26	600	10/20
81426	14	260	25/100	82840	28	400	5/10
81430	14	300	25/100	82860	28	600	5/10
81440	14	400	25/100	82880	28	800	5/10
81445	14	450	20/40				

### 2 SDS PLUS CONCRETE DRILLS

- НАБОРЫ СВЕРЛ ПО БЕТОНУ SDS PLUS
- BETONBOHRER SDS PLUS



**SDS plus**

• Delivered in plastic box

Code	Quantity (pcs.) in the set	Composition: (mm)	
81003	3	6, 8, 10 x 110	25/50
81005	5	5, 6 x 110 8, 10, 12 x 160	20/40
81005A	5	5, 6, 8, 10, 12 x 160	20/40
81006	6	6, 8, 10 x 110 6, 8, 10 x 160	20/40

### 3 SDS PLUS CONCRETE CHISELS

- ПЛОСКИЕ ЗУБИЛА ПО БЕТОНУ SDS PLUS
- BETONMEISSEL SDS PLUS

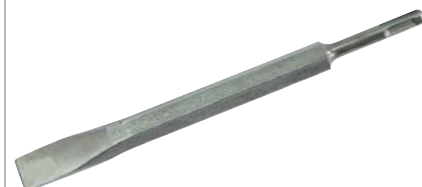

**SDS plus**

Code	Size (mm)	Width (mm)	
81702	250 x 17	20	25/50
81704	250 x 17	40	25/50

### 4 SDS PLUS CONCRETE POINT CHISEL

- ПИКООБРАЗНЫЕ ЗУБИЛА ПО БЕТОНУ SDS PLUS
- BETONLOCHWEISEN SDS PLUS



**SDS plus**

Code	Width (mm)	
81701	250 x 17	25/50

**1 SDS PLUS GROOVE CHISEL**

- КАНАВОЧНЫЕ ЗУБИЛА ПО БЕТОНУ SDS PLUS
- BETONKANALMEISSEL SDS PLUS



**SDS plus**

Code	Size [mm]	Width [mm]	
81703	250 x 17	17	25/50

**2 SDS PLUS CHUCK ADAPTER**

- АДАПТЕР (ПЕРЕХОДНИК) SDS PLUS НА СВЕРЛИЛЬНЫЙ ПАТРОН
- ADAPTER SDS PLUS



**SDS plus**

- Thread 1/2"
- SDS plus chuck with a counter bolt

Code	
80001	50/200

**3 CONCRETE CROWN SAWS**

- КОРОНЧАТЫЕ СВЕРЛА ПО БЕТОНУ
- LOCHSÄGE FÜR BETON



- Carbide teeth
- Thread M22
- Delivered in plastic tube

Code	Diameter [mm]	
82965	65	10/40
82980	80	10/20

**4 HOLE SAW ADAPTER HEX CHUCK**

- ЦЕНТРОВОЧНОЕ СВЕРЛО ДЛЯ КОРОНОК
- LOCHSÄGENADAPTER, SECHSECKIGER GRIFF



- For hole saws 82965, 82980
- Hex shank 13 mm
- Thread M22
- With a drill guide 8 mm
- Delivered in plastic tube

Code	Length [mm]	
82982	160	10/40

**5 HOLE SAW ADAPTER SDS PLUS CHUCK**

- ЦЕНТРОВОЧНОЕ СВЕРЛО ДЛЯ КОРОНОК
- LOCHSÄGENADAPTER, GRIFF SDS PLUS



- For hole saws 82965, 82980
- SDS plus chuck
- Thread M22
- With a drill guide 8 mm
- Delivered in plastic tube

**SDS plus**

Code	Length [mm]	
82985	100	10/40
82986	160	10/40

**6 CONCRETE DRILLS**

- НАБОР СВЕРЛ ПО БЕТОНУ
- BETONBOHRER



- Cylindrical grip • Delivered in plastic case

Code	Quantity [pcs.]	Sizes [mm]	
16525	5	4, 5, 6, 8, 10	50/200
16528	8	3, 4, 5, 6, 7, 8, 9, 10	50/100

**7 WOOD DRILL SETS**

- НАБОРЫ СВЕРЛ ПО ДЕРЕВУ
- HOLZBOHRER - SET



- Delivered in plastic case

Code	Quantity [pcs.]	Sizes [mm]	
26205	5	4, 5, 6, 8, 10	50/200
26208	8	3, 4, 5, 6, 7, 8, 9, 10	30/120

**8 FLAT WOOD DRILLS**

**- SET OF 6 PCS**

- НАБОР ПЕРЬЕВЫХ СВЕРЛ ПО ДЕРЕВУ – 6 ШТ.
- HOLZSPATENBOHRER - SET 6 TLG.



- Delivered in plastic case

Code	Quantity [pcs.]	Sizes [mm]	
26406	6	10, 12, 16, 18, 20, 25	25/100

**9 HSS, MASONRY AND WOOD DRILL SET**

- НАБОРЫ СВЕРЛ ПО МЕТАЛЛУ, БЕТОНУ И ДЕРЕВУ
- HSS-, MAUER- UND HOLZBOHRER-SET



- Includes drill bits for metal, concrete and wood: 4, 5, 6, 8, 10 mm [3 pcs each]

Code	Quantity [pcs.]	
47010	15	30



**1 HOLE SAW SET MADE FROM HIGH-CARBON STEEL (HCS) FOR WOOD (8 PCS.)**

- НАБОР КОРОНЧАТЫХ ПИЛ ДЛЯ ОТВЕРСТИЙ
- KNABBER FÜR BOHRUNGEN IN HOLZ



- Made of high carbon steel • The set includes: 8 cross-bits; Ø 19 mm, 22 mm, 28 mm, 32 mm, 38 mm, 44 mm, 51 mm, 64 mm; pilot drill 6 mm; adapter - 2 pcs.; driver; hex wrench
- For cutting holes in wood, gypsuboard panels - up to 25 mm deep

Code	Quantity (pcs.)	Size (mm)	
26409	8	19 - 64	30

**2 HOLE SAW SET MADE FROM HIGH-CARBON STEEL (HCS) FOR WOOD (5 PCS.)**

- НАБОР КОРОНЧАТЫХ ПИЛ ДЛЯ ОТВЕРСТИЙ
- KNABBER FÜR BOHRUNGEN IN HOLZ



- Made of high carbon steel • The set includes: 5 cross-bits; Ø 64 mm (2½"), 76 mm (3"), 89 mm (3½"), 102 mm (4"), 127 mm (5"); pilot drill 6 mm; adapter; driver; hex wrench • For cutting holes in wood, gypsuboard panels - up to 25 mm deep

Code	Quantity (pcs.)	Range	
26408	5	64 - 127	30

**3 HOLE SAWS**

- НАБОРЫ КОРОНЧАТЫХ ПИЛ ДЛЯ ОТВЕРСТИЙ
- LOCHSÄGEN



- Quenched teeth • The set includes 7 hole saws Ø: 26, 32, 38, 45, 50, 56, 63 mm, pilot drill 6 mm and a disc chuck

Code	Height of (mm)	Range (mm)	
26404	25	26 - 63	10/100
26405	50	26 - 63	10/50

**4 HOLE SAWS**

- НАБОРЫ КОРОНЧАТЫХ ПИЛ ДЛЯ ОТВЕРСТИЙ – 7 ШТ.
- LOCHSÄGEN



- The set includes 7 hole saws Ø: 26, 32, 38, 45, 50, 56, 63 mm, pilot drill 6 mm and a disc chucky

Code	Height of (mm)	Range (mm)	
26401	25	26 - 63	100
26402	50	26 - 63	10/50

**5 WOLFRAM HOLE SAW SET**

- НАБОР КОРОНЧАТЫХ ПИЛ С ВОЛЬФРАМОВЫМ НАСЫПОМ
- LOCHSÄGEN MIT WOLFRAMAUFSCHÜTTUNG



- The set includes: hole saws Ø 33, 53, 67, 73 mm; pilot drill with carbide; disc chuck

Code	Height of (mm)	Range (mm)	
26434	55	33 - 73	5/20

**6 HOLE SAWS**

- НАБОРЫ КОРОНЧАТЫХ БИМЕТАЛЛИЧЕСКИХ ПИЛ ДЛЯ ОТВЕРСТИЙ • LOCHSÄGEN



- Bimetallic hole saws • 7 pieces
- 26437 – Ø 19, 29, 33, 51, 68 mm
- 26438 – Ø 38, 44, 51, 57, 64 mm
- The set includes a body with a pilot drill
- Delivered in cardboard box

Code	Wysokość (mm)	Range	
26437	44	19 - 68	10
26438	44	38 - 64	10

**7 PROFILED CUTTERS**

- ТВЕРДОСПЛАВНЫЕ ФРЕЗЫ
- PROFILFRÄSEN

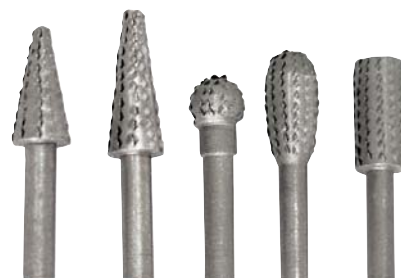

- Mandrels Ø 6 mm

Code	Quantity (pcs.) in the set		
44915	5	x	25/100

PROLINE  
LANITI PRO  
MEGA  
JUCO  
OTHER BRANDS  
ERDI  
KLINGSPOR  
EXPRESS  
ACTION CAN  
TRYTON  
VULCAN

### 1 DRILLING STAND

- ШТАТИВ ДЛЯ ДРЕЛИ
- BOHRMASCHINENSTÄNDER



- Metal stand
- Fixing diameter Ø 43 mm with presser
- Max. feed on the guide 60 mm

Code	Height (mm)	
33730	400	10

### 2 DRILL STAND

- ШТАТИВ ДЛЯ ДРЕЛИ
- BOHRMASCHINENSTÄNDER



- Metal stand
- Fixing diameter Ø 43 mm with presser
- Boring depth limiter

Code	Height (mm)	
33732	400	10

### 3 GRINDER STAND

- ШТАТИФ ДЛЯ УГЛОШЛИФОВАЛЬНОЙ МАШИНЫ
- SCHLEIFERSTÄNDER



- Metal stand

Code	Grinder disc diameter (mm)	
33715	115 / 125	10

### 4 GRINDER STAND

- ШТАТИФ ДЛЯ УГЛОШЛИФОВАЛЬНОЙ МАШИНЫ
- SCHLEIFERSTÄNDER



- Metal stand

Code	Grinder disc diameter (mm)	
33723	230	6

### 5 GRINDER STAND

- ШТАТИФ ДЛЯ УГЛОШЛИФОВАЛЬНОЙ МАШИНЫ
- SCHLEIFERSTÄNDER



- Metal stand

Code	Grinder disc diameter (mm)	
33711	115 / 125	10

### 6 STEEL BRUSH SET

- НАБОР ДИСКОВЫХ ЩЕТОК ИЗ ВОЛНИСТОЙ ПРОВОЛОКИ
- STAHLBÜRSTEN-SET



- Brushes diameters: 25, 40, 50, 60, 75 mm
- Brass-covered wire • 3 madrels

Code	Quantity pcs. in a set		
32200	8	x	20/80

### 7 SEGMENTED

#### DIAMOND DISCS

- АЛМАЗНЫЕ ДИСКИ СЕГМЕНТНЫЕ
- DIAMANT-SEGMENTSCHLEIBEN



- For dry cutting of concrete, brick, clinker
- Hole 22.2 mm

Code	Diameter (mm)	Thickness x Height (mm)		
86515	115	1.9 x 6.8	x	100/200
86525	125	2.0 x 7.7	x	100/200
86580	180	2.4 x 7.2	x	50
86630	230	2.5 x 7.5	x	25

### 8 FULL DIAMOND DISCS

- АЛМАЗНЫЕ ДИСКИ ПОЛНЫЕ
- DIAMANT-VOLLSCHLEIBEN



- For wet cutting of ceramics, tiles, clinker
- Hole 22.2 mm

Code	Diameter (mm)	Thickness x Height (mm)		
87510	110	1.9 x 5.0	x	100/200
87515	115	1.9 x 5.0	x	100/200
87525	125	2.0 x 5.0	x	100/200
87580	180	2.2 x 5.0	x	50
87630	230	2.4 x 5.0	x	25

### 9 TURBO DIAMOND DISCS

- АЛМАЗНЫЕ ДИСКИ TURBO
- DIAMANT-SCHLEIBEN TURBO



- For cutting heavy-duty concrete, stone, floor and wall tiles • Hole 22.2 mm

Code	Diameter (mm)	Thickness x Height (mm)		
88515	115	2.2 x 7.0	x	100/200
88525	125	2.4 x 7.0	x	100/200
88580	180	2.6 x 7.0	x	50
88630	230	2.8 x 7.0	x	25

### 1 METAL CUTTING DISCS

- ОТРЕЗНЫЕ ДИСКИ ДЛЯ РЕЗКИ МЕТАЛЛА
- TRENNSCHEIBE FÜR METALLE



- For steel cutting • Flat disc

Code	Size (mm)	Hole (mm)	Typ	
44311	115 x 2.5	22.2	A30S	25/100
44312	125 x 2.5	22.2	A30S	25/200
44323	230 x 2.5	22.2	A30S	10/50

### 2 GRINDING STONES

- НАБОР ШЛИФОВАЛЬНЫХ КАМНЕЙ – 5 ШТУК
- SCHLEIFSTEINE



- Mandrels Ø 6 mm

Code	Diameter (mm)		
44905	5	x	30/120

### 3 GRINDING STONES

- НАБОР ШЛИФОВАЛЬНЫХ КАМНЕЙ – 10 ШТУК
- SCHLEIFSTEINE



- Pins Ø 3 mm - 5 pcs. and Ø 6 mm - 5 pcs.

Code	Diameter (mm)		
44910	10	x	30/120

### 4 METAL STAPLE GUN / TACKER

- РУЧНОЙ СКОБЗАБИВАТЕЛЬ
- METALLTACKER



- Adjustable staple pressure force
- For staples type 53

Staples 53	Staples		Height L (mm)
	Proline	Mega	
	55306	55206	6
	55308	55208	8
	55310	55210	10
	55312	55212	12
	55314	55214	14

Code	Size (mm)		
55014	4 - 14	x	20/40

### 5 QUENCHED STAPLES TYPE 53

- ЗАКАЛЕННЫЕ СКОБЫ ТИПА 53
- GEHÄRTETE TACKERKLAMMERN TYP 53



- Sold in packs of 1000 pcs.

- For staple guns: 55024, 55028, 55014

#### Staple equivalents:

- arrow@jt-21 • stanley#a/53 • esco#530
- kwbb#053 • novus#53 • rapid#53
- rocafix#3

Code	Staples 53	Height L (mm)		
55206		6	x	50/200
55208		8	x	50/200
55210		10	x	50/200
55212		12	x	50/200
55214		14	x	50/200

### 6 CLAMPS

- ПЛАСТИКОВЫЕ ХОМУТЫ
- KLEMMSCHELLEN



- White

Code	Thickness (mm)	Length (mm)	Quantity (pcs.)		
59210B	2.5	100	100	x	250/500
59220B	2.5	200	100	x	100/200
59230B	3.6	300	100	x	75/150



- Black

Code	Thickness (mm)	Length (mm)	Quantity (pcs.)		
59210C	2.5	100	100	x	250/500
59220C	2.5	200	100	x	100/200
59230C	3.6	300	100	x	75/150

### 7 RIVETER

- ЗАКЛЕПОЧНИК
- NIETZANGE



- For aluminium blind rivets Ø 2.4, 3.2, 4.0, 4.8 mm • Rubber covers
- Bent lever

Code	Rivet size Ø (mm)		
14001	2.4 - 4.8	x	6/36

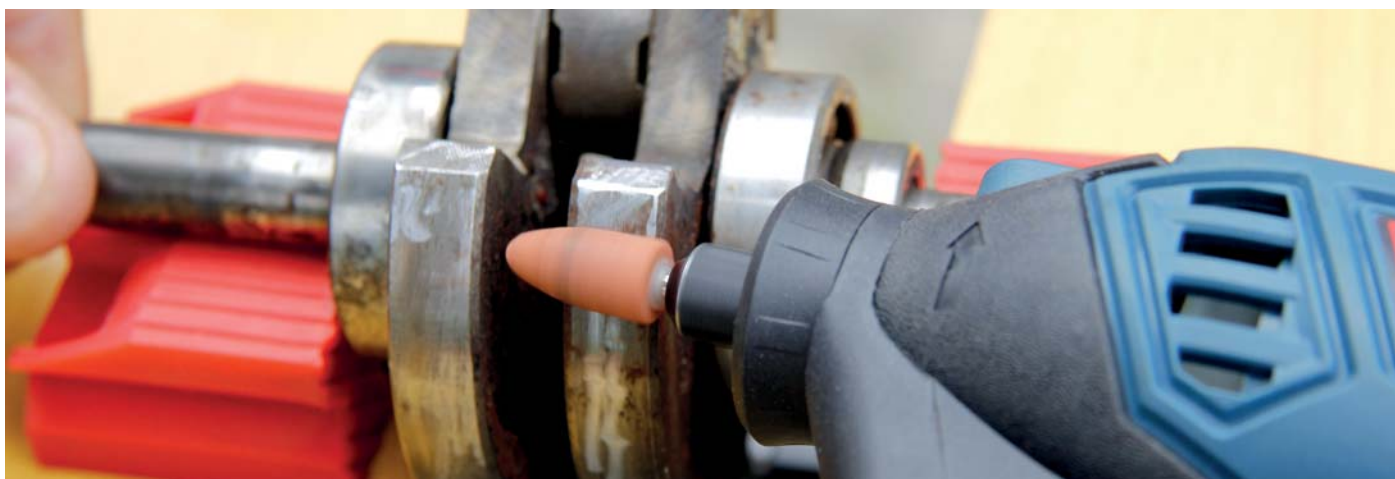

**1 TWO WAY RIVETER**

- ЗАКЛЕПОЧНИК ДВУХСТОРОННЕГО НАПРАВЛЕНИЯ
- ZWEI-WEGE-NIETMASCHINE



- The riveter head works at 90° and 180°
- For 2.4, 3.2, 4.0, 4.8 mm aluminium blind rivets
- Rubber sockets

Code	Rivet size Ø (mm)		
14002	2.4 - 4.8	x	6/24

**2 LEVER RIVETER**

- ЗАКЛЕПОЧНИК РЫЧАЖНЫЙ
- HEBELNIETZANGE



- For aluminium blind rivets Ø 2.4, 3.2, 4.0, 4.8 mm

Code	Rivet size Ø (mm)		
14005	2.4 - 4.8	x	12

**3 BLIND RIVETS**

- АЛЮМИНИЕВЫЕ ЗАКЛЕПКИ
- ALUMINIUM BLINDNIETE



- Delivered in a plastic bag 50 pcs.

Code	Ø x L (mm)	Quantity (pcs.)		
59307	3.2 x 7.0	50	x	25/250
59310	3.2 x 10.0	50	x	25/200
59312	3.2 x 12.0	50	x	25/200
59408	4.0 x 8.0	50	x	25/200
59410	4.0 x 10.0	50	x	25/200
59412	4.0 x 12.0	50	x	25/200
59416	4.0 x 16.0	50	x	25/200
59418	4.0 x 18.0	50	x	25/200
59508	4.8 x 8.0	50	x	25/200
59510	4.8 x 10.0	50	x	25/200
59512	4.8 x 12.0	50	x	25/150
59514	4.8 x 14.0	50	x	25/150
59518	4.8 x 18.0	50	x	25/150
59523	4.8 x 23.0	50	x	25/100

- Delivered in plastic box

Code	Ø x L (mm)	Quantity (pcs.)	
59399	3.2 x 10.0	1000	20
59499	4.0 x 12.0	800	16
59599	4.8 x 10.0	500	16

**4 TRANSFORMER SOLDERING GUN 150 W**

- ТРАНСФОРМАТОРНЫЙ ПАЯЛЬНИК 150ВТ
- TRANSFORMATORLÖTMASCHINE 150 W



- Voltage 230 V

Code	Power [W]	
60070	150	20

**5 TRANSFORMER SOLDERING GUN 100 W**

- ТРАНСФОРМАТОРНЫЙ ПАЯЛЬНИК 100ВТ
- TRANSFORMATORLÖTMASCHINE 100 W



- Voltage 230 V

Code	Power [W]	
60069	100	20



### 1 RESISTANCE SOLDERING GUNS

- ПАЯЛЬНИКИ
- WIDERSTANDSLÖTMASCHINEN



- Voltage 230 V • With a metal support

Code	Power (W)	
60072	25	25/50
60074	40	25/50
60076	60	25/50
60080	100	25/50

### 2 SOLDERING UNIT BITS 60070

- НАБОР НАКОНЕЧНИКОВ ДЛЯ ТРАНСФОРМАТОРНОГО ПАЯЛЬНИКА – 3 ШТУКИ • LÖTSPITZEN 60070

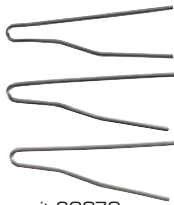

- For soldering unit 60070
- Sold in sets of 3 pcs.

Code	Quantity in a set (pcs.)	
60090	3	100/500

### 3 SOLDERING UNIT BITS 60069

- НАБОР НАКОНЕЧНИКОВ ДЛЯ ТРАНСФОРМАТОРНОГО ПАЯЛЬНИКА – 3 ШТУКИ • LÖTSPITZEN 60069

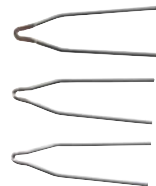

- For soldering unit 60069
- Sold in sets of 3 pcs.

Kód	Quantity in a set	
60089	3	100/500

### 4 GAS TORCH

- МИНИ ГАЗОВЫЙ ПАЯЛЬНИК - РУЧКА
- GASBRENNER



- Used for melting, soldering of silver, gold, copper, aluminium, tin, glass tubes and other materials with low thermal capacity

Code	Temp.		
60030	1300°C	x	25/100

### 5 AIR INFLATOR WITH PRESSURE GAUGE

- ПНЕВМАТИЧЕСКИЙ ПИСТОЛЕТ ДЛЯ ПОДКАЧКИ КОЛЕС С МАНОМЕТРОМ
- PISTOLE FÜR DAS AUFPUMPEN VON REIFEN MIT MANOMETER



- Pressure gauge dia. 63 mm with hose 40 cm long • Max. air pressure 6 Bar
- Quick acting unit 1/4"

Code		
66246	x	20/40

### 6 CLEANING GUN

- ПНЕВМАТИЧЕСКИЙ МОЕЧНЫЙ ПИСТОЛЕТ
- PISTOLE ZUM WASCHEN



- With container 0.9 litre
- Max. air pressure 6 Bar
- For all fluid types
- Quick acting unit 1/4"
- Compressed air consumption

Code		
66247	x	1/20

### 7 AIR SPRAY GUN

- ПНЕВМАТИЧЕСКИЙ КРАСКОПУЛТ
- LACKIERPISTOLE



- With lower container vol. 1 litre
- Max. air pressure 3 Bar
- Adjustable paint flow
- Compressed air consumption 200 l/min.
- Quick acting unit 1/4"

Code	
66244	10

### 8 AIR SPRAY GUN

- ПНЕВМАТИЧЕСКИЙ КРАСКОПУЛТ
- LACKIERPISTOLE



- With upper container vol. 0.6 litre
- Max. air pressure 3 Bar
- Compressed air consumption 200 l/min.
- Adjustable paint flow
- Quick acting unit 1/4"

Code	
66245	20

### 9 AIR GUN KIT

- НАБОР ПРИНАДЛЕЖНОСТЕЙ ДЛЯ КОМПРЕССОРА
- LACKIERSET



- The set includes: air inflator with pressure gauge, air-purge gun, cleaning gun, air spray gun (for any paint type), spiral hose 5 m
- Quick acting unit 1/4"

Code	
66243	10

**1 COIL HOSES**

- СПИРАЛЬНЫЕ ШЛАНГИ
- SPIRALSCHLAUCH



- With quick acting units attached for hoses with tips 6/8 mm

Code	Length (mm)	
66250	5	50
66251	10	50
66252	15	20
66253	20	20

**2 CLOSE SHACKLE BRASS PADLOCKS**

- НАВЕСНЫЕ ЛАТУННЫЕ СТЕРЖНЕВЫЕ ЗАМКИ
- BOLZENSCHLÖSSER, MESSING



- Quenched bolt • 3 keys

Code	Size (mm)		
24550	50		6/72
24565	65		6/60
24575	75		6/48
24590	90		6/36
24550K	50	x	12/96
24565K	65	x	12/60
24575K	75	x	12/48
24590K	90	x	12/36

**3 BRASS PADLOCKS**

- НАВЕСНЫЕ ЛАТУННЫЕ ЗАМКИ • MESSINGSCHLÖSSER



- Quenched shackle

Code	Size (mm)		
24232	32		12/240
24240	40		12/120
24250	50		6/72
24263	63		6/60
24232K	32	x	12/240
24240K	40	x	12/120
24250K	50	x	6/72
24263K	63	x	6/60

**4 QUENCHED CAST IRON PADLOCKS**

- НАВЕСНЫЕ ЧУГУННЫЕ ЗАМКИ
- GUSSEISENSCHLÖSSER, GEHÄRTET



- Quenched shackle

Code	Size (mm)		
24432	32		12/240
24440	40		12/240
24450	50		6/120
24463	63		6/60
24475	75		6/36
24432K	32	x	6/240
24440K	40	x	6/240
24450K	50	x	6/120
24463K	63	x	6/60
24475K	75	x	6/36

**5 STEEL CABLE LOCKS**

- НАВЕСНЫЕ СТАЛЬНЫЕ ТРОСЫ -ЗАМКИ
- ANTI-EINBRUCH-STAHLEINEN



- PVC-coated rope
- Lock with a key
- 24901 - chromium-plated lock
- 24902 - coated lock

Code	Length (mm)		
24901	550	x	10/120
24902	550	x	10/120

**6 STEEL CABLE LOCKS**

- НАВЕСНЫЕ СТАЛЬНЫЕ ТРОСЫ -ЗАМКИ
- ANTI-EINBRUCH-STAHLEINEN

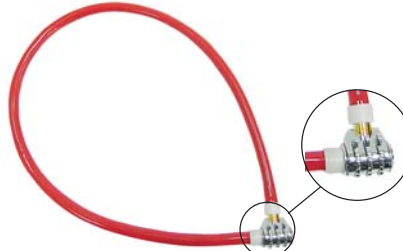

- PVC-coated rope
- Chromium-plated 3-digit cipher lock

Code	Length (mm)		
24905	550	x	30/120

**7 STEEL CABLE LOCK**

- НАВЕСНОЙ СТАЛЬНОЙ ТРОС -ЗАМОК
- ANTI-EINBRUCH-STAHLEINE



- PVC-coated rope
- Lock with a key, coated
- A tip for installing on the tube, e.g. under the saddle

Code	Size (mm)		
24903	6 x 800	x	120

**8 ASSYMMETRIC LOCK CYLINDERS**

- ЦИЛИНДРИЧЕСКИЕ СЕРД ЦЕВИНЫ ДЛЯ ЗАМКА
- ZYLINDEREINSÄTZE



- Brazen • Assymmetric • 3 keys

Code	Size (mm)		
24670	70 mm (30 / 40)		12/120
24670K	70 mm (30 / 40)	x	12/120

**9 LOCK CYLINDERS**

- ЦИЛИНДРИЧЕСКИЕ СЕРД ЦЕВИНЫ ДЛЯ ЗАМКА
- ZYLINDEREINSÄTZE



- Brazen • Symmetric • 3 keys

Code	Size (mm)		
24662	62		12/120
24662K	62	x	12/120

**10 LOCK CYLINDERS**

- ЦИЛИНДРИЧЕСКИЕ СЕРД ЦЕВИНЫ ДЛЯ ЗАМКА
- ZYLINDEREINSÄTZE



- Quenched bolt • 6 keys

Code	Size (mm)		
24666	62		12/120
24666K	62	x	12/120

### 1 RUBBER TIE-DOWN SETS

- РЕЗИНКИ ДЛЯ БАГАЖНИКА
- KOFFERRAUMSPANNURTE



- Coated, stretchy rubber rope with metal hooks

Code	Length (cm)	Set pcs.		
24778	80	2	x	100
24780	100	2	x	144

### 2 RATCHET TIE-DOWN TAPE

- ЛЕНТА -ФИКСАТОР ГР УЗА • BEPÄCKSPANNURTE



- With tensioner

Code	Length (cm)	Width (mm)		
24785	5	25	x	48

### 3 BOOSTER CABLES

- СТАРТОВЫЕ ПРОВОДА „ДЛЯ ПРИК УРИВАНИЯ“ • STARTERKABEL



Code	Current (A)	Length (m)		
24712	120	2.4	x	20

### 4 FOOT PUMP WITH GAUGE

- НОЖНОЙ НАСОС С МАНОМЕТРОМ • FUSSPUMPE MIT MANOMETER



Code	Max pressure (atm)		
24760	3	x	25

### 5 TARPULINS

- ПОКРЫВОЧНЫЕ ТЕНТЫ
- ABDECKPLANE



Code	Dimensions (m +/- 5%)	
46323	2x3	50
46335	3x5	20
46345	4x5	10
46346	4x6	12
46358	5x8	8
46361	6x10	5
46381	8x12	3
46311	10x15	2

### 6 CRYPTON TORCH

- КРИПТОНОВЫЙ ФОНАРИК
- KRYPTON-TASCHENLAMPE



- Non-slip rubber casing
- With two D-type batteries
- Designed for use in various weather conditions

Code	Length (mm)	Work mode		
51017	190	100% continuous light	x	10/50

### 7 LED TORCH

- ФОНАРИК LED
- LED-TASCHENLAMPE



- Non-slip rubber casing
- With two AA batteries
- Designed for use in various weather conditions

Code	Length (mm)	Work mode		
51028	160	100% continuous light	x	24/48

### 8 LED TORCH

- ФОНАРИК LED
- LED-TASCHENLAMPE



- With two D-type batteries
- Source of light - 13 LEDs

Code	Length (mm)	Work mode		
51022	170	100%	x	6/24

### 9 LED TORCH

- ФОНАРИК LED
- LED-TASCHENLAMPE



- Magnetic holder and a hook to facilitate fixing
- With three AAA batteries
- Additional LEDs for spot lighting
- Source of light 24 + 3 LEDs

Code	Length (mm)	Work mode		
51027	120	100%	x	20/80

### 10 LED TORCH

- ФОНАРИК LED
- LED-TASCHENLAMPE



- Magnetic holder and a hook to facilitate fixing
- With two AA batteries
- Source of light 24 LEDs

Code	Length (mm)	Work mode		
51026	210	100%	x	20/60

PROLINE  
LANTY PRO  
MEGA  
JUCO  
OTHER BRANDS  
ERDI  
KLINGSPOR  
EXPRESS  
ACTION CAN  
TRYTON  
VULCAN

### 1 HIGH POWER LED HEAD TORCH

- ФОНАРИК HIGH POWER LED
- STIRNTASCHENLAMPE HIGH POWER LED



- Rubber tape enabling to put the torch on your head
- Arm to change the lighting angle
- With three AAA batteries
- High-quality source of light POWER LED 1W

Code	Length (mm)	Work mode		
51024	90	100%/50%/flash	x	12 / 48

### 2 PORTABLE HALOGEN LAMP WITH STAND

- ЛАМПА ПЕРЕНОСНАЯ ГАЛОГЕННАЯ НА ШТАТИВЕ
- MOBILE HALOGENLAMPE MIT GRIFF UND STATIV



- Lamp on a stand 2x500W • Power supply: 220 ~ 240V/AC IP44 • Power frequency: 50-60Hz • High-pressure cast aluminium body, powder-coated • High-quality aluminium reflecting surface; tempered glass
- Max: 2x500W 118 mm R7x
- Stand adjustable in the range of: 85-178 cm
- 2m electrical cord with a plug

Code	Power (W)	Source of light		
66157	500	2x		2

### 3 WALL HALOGEN LAMPS

- ЛАМПЫ НАСТЕННЫЕ ГАЛОГЕННЫЕ • WANDHALOGENLAMPEN



- Halogen lamp 150W / 500W • Power: 220 ~ 240V/AC IP44 • Supply frequency: 50-60Hz • High-pressure cast aluminium body, powder-coated
- High-quality aluminium reflecting surface; tempered glass • Max: 150W 78 mm R7x
- Max: 500W 118mm R7x • Work humidity: <93% RH

Code	Power (W)	Source of light		
66150	150	1x		20
66151	500	1x		20

### 4 PORTABLE HALOGEN LAMP WITH STAND

- ЛАМПА ПЕРЕНОСНАЯ ГАЛОГЕННАЯ НА ШТАТИВЕ
- MOBILE HALOGENLAMPE MIT GRIFF UND STATIV



- Lamp on a stand 2x500W • Power supply: 220 ~ 240V/AC IP44 • Power frequency: 50-60Hz • High-pressure cast aluminium body, powder-coated • High-quality aluminium reflecting surface; tempered glass
- Max: 1x500W 118 mm R7x
- Stand adjustable in the range of: 85-178 cm
- 2m electrical cord with a plug

Code	Power (W)	Source of light		
66156	500	1x		2

### 5 WALL HALOGEN LAMPS WITH MOTION DETECTOR

- ЛАМПЫ НАСТЕННЫЕ ГАЛОГЕННЫЕ С ДАТЧИКОМ ДВИЖЕНИЯ
- WANDHALOGENLAMPEN MIT SENSOR



- Halogen lamp with motion detector 150W / 500W • Power: 220 ~ 240V/AC IP44
- Power frequency: 50-60Hz
- High-pressure cast aluminium body, powdercoated
- High-quality aluminium reflecting surface; tempered glass
- Ambient light: <5Lux ~ 2000Lux (adjustable)
- Range: 12m • Delay time: 5sek ~ 8min (adjustable)
- Installation height: 1.8 ~ 2,5 m • Motion detection: 0.6-1.5m / s • Max: 150W 78 mm R7x • Max: 500W 118mm R7x
- Work humidity: <93% RH

Code	Moc (W)	Source of light		
66152	150	1x		10
66153	500	1x		10

### 6 PORTABLE HALOGEN LAMPS

- ЛАМПЫ ПЕРЕНОСНЫЕ ГАЛОГЕННЫЕ
- MOBILE HALOGENLAMPE MIT GRIFF UND STATIV



- Lamp with a handle 150W / 500W
- Power supply: 220 ~ 240V/AC IP44
- Power frequency: 50-60Hz
- High-pressure cast aluminium body, powdercoated
- High-quality aluminium reflecting surface; tempered glass • Max: 150W 118 mm R7x
- Max: 500W 118 mm R7x • Stand with adjustable lamp tilting, carrying handle
- 1.5 m electric cable with a plug

Code	Moc (W)	Source of light		
66154	150	1x		20
66155	500	1x		6



**1 WORKSHOP PORTABLE LAMP**

- ЛАМПА ПЕРЕНОСНАЯ РЕМОНТНАЯ
- TRAGBARE WERKSTATT-LAMPE



**IP20 60W**

Code	Power (W)		
EZ60WM	60	x	20

**2 WORKSHOP PORTABLE LAMP**

- ЛАМПА ПЕРЕНОСНАЯ РЕМОНТНАЯ
- TRAGBARE WERKSTATT-LAMPE



**IP20 60W**

Code	Power (W)		
EZ60WP	60	x	10

**3 LEATHER TOOL BELT**

- ПОЯС ДЛЯ ИНСТРУМЕНТА (ПОЯС МОНТАЖНИКА)
- MONTAGEGURT, VERSTÄRKT, MIT TASCHE



- Leather
- Two large and two small nail pockets, 6 tool pockets, 2 hammer loops, 1 measuring tape holder
- Delivered in a plastic bag with a hanger

Code	
52011	50

**4 HAND PRUNER**

- САДОВЫЙ СЕКАТОР
- GARTENSCHERE



- Max cutting diameter – 12 mm
- Quenched steel blade

Code	Length (mm)		
40005	200	x	12/72

**5 HAND PRUNER**

- САДОВЫЙ СЕКАТОР
- GARTENSCHERE



- Max cutting diameter – 15 mm
- Quenched steel blade

Code	Length (mm)		
40006	200	x	12/72

**6 WIRE RAKE**

- СТАЛЬНЫЕ ПРОВОЛОЧНЫЕ ГРАБЛИ
- DRANTHARKE



- Steel rake • 15 teeth • Detachable
- Vinyl-coated metal lock

Code		
40090	x	12



# JUCO

adjustable spanners

axes

chisels

crowbars

hammers

pliers

saw frames

shovels

snips

spades

splitting wedges

and many others...



### 1 COMBINATION PLIERS 1000V

- ПЛОСКОГУБЦЫ УНИВЕРСАЛЬНЫЕ 1000В ПОЛИРОВАННЫЕ
- KOMBIZANGE 1000V



- Ergonomic two-component PVC covers

Code	Size (mm)	
28590	160	10
28591	180	10
28592	200	10

### 2 COMBINATION PLIERS - 1000 V

- ЭЛЕКТРОТЕХНИЧЕСКИЕ УНИВЕРСАЛЬНЫЕ ПЛОСКОГУБЦЫ - 1000В • KOMBIZANGE 1000V



- Forged, made from high-grade tool steel
- Quenched • Ergonomic PVC covers

Code	Size (mm)	
28531	160	10
28532	180	10
28533	200	10

### 3 SIDE-CUTTING PLIERS 1000V

- БОКОРЕЗЫ 1000В ПОЛИРОВАННЫЕ
- SEITENSCHNEIDER 1000V



- Ergonomic two-component PVC covers

Code	Size (mm)	
28593	140	10
28594	160	10
28595	180	10



### 4 DIAGONAL SIDE CUTTERS - 1000 V

- ЭЛЕКТРОТЕХНИЧЕСКИЕ БОКОРЕЗЫ - 1000В
- DIAGONAL-SEITENSCHNEIDER - 1000V



- Forged, made from high-grade tool steel
- Quenched • Polished • Ergonomic PVC covers

Code	Size (mm)	
28570	140	10
28571	160	10
28572	180	10



### 5 SNIPE NOSE PLIERS 1000V TWO COMPONENTS

- ТОНКОГУБЦЫ 1000В ПОЛИРОВАННЫЕ ДВУХКОМПОНЕНТНЫЕ
- SPITZZANGE - 1000V ZWEI KOMPLEMENTEN



- Ergonomic two-component PVC covers

Code	Size (mm)	
28596	160	10
28597	200	10

### 6 SNIPE NOSE PLIERS - 1000 V

- ЭЛЕКТРОТЕХНИЧЕСКИЕ ПРЯМЫЕ ПОЛУКРУГЛЫЕ ПЛОСКОГУБЦЫ - 1000 В (ТОНКОГУБЦЫ) • SPITZZANGE - 1000 V



- Forged, made from high-grade tool steel
- Quenched • Polished • Ergonomic PVC covers

Code	Size (mm)	
28573	160	10
28574	200	10

### 7 FLAT NOSE PLIERS 1000V

- ПЛОСКОГУБЦЫ 1000В ПОЛИРОВАННЫЕ
- FLACHZANGE 1000V



- Ergonomic two-component PVC covers

Code	Size (mm)	
28598	160	10

### 8 FLAT NOSE PLIERS - 1000 V

- ЭЛЕКТРОТЕХНИЧЕСКИЕ ПРЯМЫЕ ПЛОСКОГУБЦЫ - 1000 В (УТКОНОСЫ) • FLACHZANGE 1000 V



- Forged, made from high-grade tool steel
- Quenched • Polished • Ergonomic PVC covers

Code	Size (mm)	
28577	160	10

PROLINE  
LANITI PRO  
MEGA  
JUCO  
OTHER BRANDS  
ERDI  
KLINGSPOR  
EXPRESS  
ACTION CAN  
TRYTON  
VULCAN

**1 ROUND NOSE PLIERS 1000V**

- КРУГЛОГУБЦЫ 1000В ПОЛИРОВАННЫЕ
- RUNDZANGE 1000 V



- Ergonomic two-component PVC covers

Code	Size (mm)	
28599	160	10

**2 ROUND NOSE PLIERS-1000 V**

- ЭЛЕКТРОТЕХНИЧЕСКИЕ КРУГЛОГУБЦЫ – 1000В
- RUNDZANGE 1000 V



- Forged, made from high-grade tool steel
- Quenched • Polished • Ergonomic PVC covers

Code	Size (mm)	
28575	160	10



**3 END CUTTING PLIERS**

- ЩИПЦЫ (КУСАЧКИ) ТОРЦЕВЫЕ • FRONTSCHNEIDER



- Forged, made from high-grade steel • Quenched
- PVC-coated handles

Code	Size (mm)	
28551	180	10

**4 HEAVY DUTY SIDE CUTTER**

- КУСАЧКИ ДЛЯ ПРОВОЛОКИ • DRAHTSCHNEIDER



- Forged, made from high-grade steel • Quenched
- PVC-coated handles

Code	Size (mm)	
28506	260	10

**5 END CUTTING PLIERS**

- ЩИПЦЫ (КУСАЧКИ) ТОРЦЕВЫЕ ДЛЯ ПРОВОЛОКИ
- GELENKFRONTSCHNEIDER



- Forged, made from high-grade steel
- Quenched • Lever mechanism facilitating cutting • Ergonomic handles coated with PVC

Code	Size (mm)	
28553	210	10

**6 RABBIT PINCERS**

- ЩИПЦЫ (КУСАЧКИ) ШТУКАТУРНЫЕ • MONIERZANGE



- Forged, made from high-grade steel • Quenched
- PVC-coated handles

Code	Size (mm)	
28502	220	10
28503	250	10

**7 PINCERS**

- КЛЕЩИ • KNEIFZANGE



- Forged, made from high-grade steel
- Quenched • Polished head • PVC-coated handles

Code	Size (mm)	
28561	160	10
28562	180	10
28563	200	10

**8 CIRCLIP PLIERS**

- ЩИПЦЫ ДЛЯ СТОПОРНЫХ КОЛЕЦ
- SICHERUNGSRINGZANGE FÜR INNENRINGE



- Forged, made from high-grade steel
- Polished • PVC-coated handles

Code	Size (mm)	Typ	Type	
28543	180	ext.	curved	10
28544	200	ext.	curved	10
28541	180	int.	curved	10
28542	200	int.	curved	10
28547	180	ext.	straight	10
28548	210	ext.	straight	10
28545	180	int.	straight	10
28546	210	int.	straight	10

## 1 ADJUSTABLE SPANNERS

• РАЗВОДНЫЕ КЛЮЧИ • VERSTELLBARE SCHRAUBENSCHLÜSEL



• Made from C45 steel

Code	Size (mm)	
28205	200	10
28206	250	10
28207	300	10

## 2 WATERPUMP PLIERS

• КЛЕЩИ САНТЕХНИЧЕСКИЕ • ROHRZANGE



• Made from C45 steel • PVC-coated handles

Code	Size (mm)	
28208	240	10

## 3 WATERPUMP PLIERS

• КЛЕЩИ САНТЕХНИЧЕСКИЕ • ROHRZANGE



**HRC**  
45±2

• Forged from high-grade steel • Quenched  
• PVC-coated handles

Code	Size (mm)	
28209	240	10



## 4 WATERPUMP PLIERS

• ПЕРЕСТАВНЫЕ КЛЮЧИ ДЛЯ ТРУБ  
• WASSERPUMPENZANGE



**HRC**  
45±2

• Forged, made from high-grade steel  
• Quenched • Furrowed jaws increase gripping force

Code	Size (mm)	
28202	250	10
28203	315	10

## 5 AVATION SNIPS

• НОЖИЦЫ ПО МЕТАЛЛУ ШАРНИРНЫЕ • GELENKSCHERE



**HRC**  
44±2

• Made from high-grade steel  
• Quenched • With joints • Ergonomic PCV covers on the handles

Code	Size (mm)	Type	
17104	230	straight	10

## 6 TINMAN'S SNIPS

• ЛИСТОВЫЕ НОЖИЦЫ ПО ЖЕСТИ • BLECHSCHERE



**HRC**  
44±2

• Made from high-grade steel • Blades quenched in zones • Hardness 44 ± 2 HRC  
• Jointed • PVC-coated handles

Code	Size (mm)	Type	
17101	260	straight	10
17102	260	right	10
17103	260	left	10

## 7 HACKSAW FRAME

• НОЖОВКА ПО МЕТАЛЛУ • METALLBÜGELSÄGE



• Robust bow made from C45 steel  
• Wooden handle  
• Total length 520 mm

Code	Size (mm)	
23103	300	5



**1 FLAT COLD CHISELS**

• ЗУБИЛА • SCHLOSSERMEISSEL



**HRC**  
52±2

- Hot-forged • Quenched work part
- Coated • Tool steel C45 • Rectangular profile

Code	Length [mm]	Profile dimension [mm]	
13701	150	20 x 10	10
13702	200	20 x 10	10
13700	250	20 x 10	10
13703	300	25 x 10	10
13704	400	30 x 12	10

**2 FLAT COLD CHISELS**

• ЗУБИЛА С ПРОТЕКТОРОМ  
• MAURERMEISSEL MIT SCHUTZ



**HRC**  
52±2

- Hot-forged • Quenched work part
- Coated • Tool steel C45 • PVC guard • Hex profile

Code	Length [mm]	Profile dimension [mm]	
13717	250	17	5
13713	300	17	5
13718	350	17	5
13714	400	19	5
13715	500	19	5

**3 POINT COLD CHISELS**

• КЕРНЫ С ПРОТЕКТОРОМ  
• MAURERMEISSEL MIT SCHUTZ

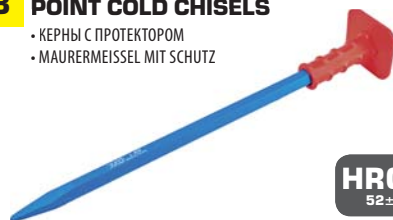

**HRC**  
52±2

- Hot-forged • Quenched work part
- Coated • Tool steel C45 • PVC guard • Hex profile

Code	Length [mm]	Profile dimension [mm]	
13723	300	17	5
13725	500	19	5

**4 CROWBAR**

• ГВОЗДОДЕР • NAGELEISEN



**HRC**  
45±2

- Hot-forged • Quenched work part (remover)
- Coated • Tool steel C45 • Hex profile

Code	Length [mm]	Profile dimension [mm]	
13611	300	14	5

**5 FLAT EXTRACTOR - CROWBARS FOR NAILS**

• ЛОМЫ - ГВОЗДОДЕРЫ ПЛОСКИЕ  
• FLACHABZIEHER - BREICHEISEN FÜR NÄGEL



**HRC**  
45±2

- Hot-forged • Quenched work part (remover)
- Coated • Tool steel C45 • Rectangular profile

Code	Length [mm]	Profile dimension [mm]	
13612	450	35x5	5
13613	500	35x5	5

**6 EXTRACTOR - CROWBARS FOR NAILS**

• ЛОМЫ - ГВОЗДОДЕРЫ  
• ABZIEHER - BREICHEISEN FÜR NÄGEL



**HRC**  
45±2

- Quenched work part (remover)
- Coated • Tool steel C45 • Hex profile

Code	Length [mm]	Profile dimension [mm]	
13615	350	17	5
13616	550	17	5

**7 CROWBARS**

• ГВОЗДОДЕРЫ • NAGELEISEN

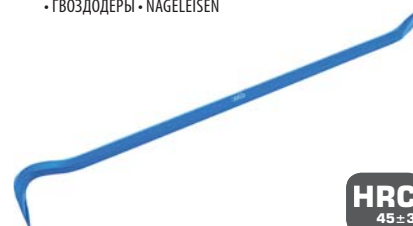

**HRC**  
45±3

- Hot-forged • Quenched work parts (blade and remover) • Coated • Tool steel C45 • Hex profile

Code	Length [mm]	Profile dimension [mm]	
13604	400	17	5
13605	500	17	5
13606	600	17	5
13607	700	17	5
13608	800	17	5
13609	900	19	5
13610	1000	19	5

**8 POINT CROWBARS**

• СТРОИТЕЛЬНЫЕ ЛОМЫ • SPITZE BREICHEISEN



**HRC**  
45±2

- Quenched work part (at the ends)
- Coated • Tool steel C45 • Round profile

Code	Length [mm]	Profile dimension [mm]	
13620	1000	23	1
13602	1200	26	1
13603	1500	28	1
13601	1600	28	1

**9 PLANE MASONRY CROWBARS**

• СТРОИТЕЛЬНЫЕ ЛОМЫ • FLACHE MAURER-BREICHEISEN



**HRC**  
45±2

- Quenched work part (at the ends)
- Coated • Tool steel C45 • Round profile

Code	Length [mm]	Profile dimension [mm]	
13621	1000	26	1
13622	1200	26	1
13625	1500	26	1
13626	1600	26	1

**10 CENTRE PUNCH**

• СЛЕСАРНЫЙ КЕРН  
• SCHLOSSERKÖRNER



**HRC**  
52±3

- Quenched blade • Coated • Hardness 52 ± 2 HRC • Tool steel C45 • Hex profile

Code	Length [mm]	Profile dimension [mm]	
13600	100	10	25

# Hammers

## 1 MACHINIST HAMMERS

- СЛЕСАРНЫЕ МОЛОТКИ
- SCHLOSSERHÄMMER



**HRC**  
43±3

**DIN 1041** **DIN 1042**

- Hot forged • Quenched at the ends
- Coated and ground • Hardness 43 ± 3 HRC
- Made from C45 steel • Wooden handle

Code	Weight (g)	Handle length (mm)	
12401	100	260	10
12402	200	280	10
12403	300	300	10
12405	500	320	10
12407	700	340	10
12410	1000	360	10
12415	1500	380	6
12420	2000	400	6
12430	3000	600	1
12440	4000	700	1
12450	5000	800	1
12460	6000	800	1
12480	8000	900	1
12400	10000	900	1

## 2 MACHINIST HAMMERS

- СЛЕСАРНЫЕ МОЛОТКИ
- CHLOSSERHÄMMER



**HRC**  
43±3

**DIN 1041** **DIN 1042**

- Hot forged • Quenched at the ends
- Ground • Heads covered with a special agent making a transparent anticorrosion surface • Made from C45 steel • Wooden handle

Code	Weight (g)	Handle length (mm)	
12421	100	260	10
12422	200	280	10
12423	300	300	10
12425	500	320	10
12427	700	340	10
12429	1000	360	10
12435	1500	380	6
12439	2000	400	6
12443	3000	600	1
12444	4000	700	1
12445	5000	800	1
12446	6000	800	1
12448	8000	900	1
12449	10000	900	1

## 3 SPLITTING HAMMERS

- КУВАЛДЫ
- VORSCHLAGHAMMER



**HRC**  
43±3

**DIN 1041** **DIN 1042**

- Hot forged • Quenched at the ends
- Coated and ground • Made from C45 steel
- Wooden handle

Code	Weight (g)	Handle length (mm)	
12470	1000	360	10
12471	1500	380	6
12472	2000	400	6
12473	3000	600	1
12474	5000	800	1
12476	6000	800	1
12478	8000	900	1
12479	10000	900	1

## 4 ROOFING HAMMER

- ПЛОТНИЦКИЙ МОЛОТОК • ZIMMERMANNSHAMMER



**HRC**  
43±2

- Hot forged • Quenched working surfaces of the head • Made from C45 steel • Metal shank with PVC handle • Magnetic insert in the head for holding nails

Code	Weight (g)	Handle length (mm)	
12489	600	320	5

## 5 MONOBLOCK ROOFING HAMMER

- МОЛОТОК ПЛОТНИЦЫЙ, МОНОБЛОК
- MONOBLOCK-DACHHAMMER



- The whole metal part forged • Quenched working surfaces of the head • Magnetic insert in the head for holding nails • Metal shank with PVC handle

Code	Weight (g)	Handle length (mm)	
12490	700	320	5

## 6 MASONRY HAMMER

- МОЛОТОК КАМЕНЩИКА • MAURERHAMMER



**HRC**  
43±2

- Hot forged • Quenched working surfaces of the head • Made from C45 steel • Metal shank with PVC handle • Magnetic insert in the head for holding nails

Code	Weight (g)	Handle length (mm)	
12488	700	320	5

## 7 MONOBLOCK MASONRY HAMMER

- МОЛОТОК КАМЕНЩИКА • MONOBLOCK-MAURERHAMMER



- The whole metal part forged • Quenched working surfaces of the head • Magnetic insert in the head for holding nails • Metal shank with PVC handle

Code	Weight (g)	Handle length (mm)	
12487	700	320	5

## 8 MASONRY HAMMER

- МОЛОТОК КАМЕНЩИКА • MAURERHAMMER



**HRC**  
43±3

- Hot forged • Quenched at ends • Coated and ground • Wooden handle

Code	Weight (g)	Handle length (mm)	
12207	700	350	5

## 9 STONE HAMMERS

- КУВАЛДЫ • STEINMETZHAMMER



**HRC**  
43±3

- Hot-forged • Quenched at ends
- Coated and ground • Made from C45 steel
- Two-sided head • Wooden handle

Code	Weight (g)	Handle length (mm)	
12481	1000	360	10
12482	2000	400	6
12483	3000	600	1
12485	5000	800	1
12486	6000	800	1

PROLINE

LAHTI PRO

MEGA

JUCO

OTHER BRANDS

ERDI

KUNGSFOR

EXPRESS

ACTION CAN

TRAYTON

VULCAN



**1 HAND AXES**

• ТОПОРЫ • TRADITIONELLE ÄXTE



**HRC** 46±2 **DIN** 5131 **DIN** 7294

- Hot-forged • Quenched blades • Coated and ground • Wooden handle

Code	Weight (g)	Handle length (mm)	
12214	400	340	5
12306	600	360	5
12308	800	380	5
12310	1000	500	5
12312	1250	700	5
12315	1500	700	5
12318	1800	800	5
12320	2000	800	5
12326	2500	900	5

**2 HAND AXES**

• ТОПОРЫ • TRADITIONELLE ÄXTE



**HRC** 46±2 **DIN** 5131 **DIN** 7294

- Hot-forged • Quenched blades • Ground
- Heads covered with a special agent making a transparent anticorrosion surface
- Wooden handle

Code	Weight (g)	Handle length (mm)	
12304	400	340	5
12305	600	360	5
12307	800	380	5
12309	1000	500	5
12314	1250	700	5
12316	1500	700	5
12317	1800	800	5
12319	2000	800	5
12324	2500	900	5

**3 HAND AXE CANADIAN**

• ТОПОР КАНАДСКИЙ • KANADISCHE AXT



**HRC** 46±2

- Hot-forged • Quenched blades • Made from C45 steel • Wooden handle

Code	Weight (g)	Handle length (mm)	
12323	1800	800	5

**4 KICHEN AXE**

• ТОПОРИК КУХОННЫЙ • KÜCHENBEIL



**HRC** 46±2

- Polished head with a quenched blade
- Metal shank with PVC handle

Code	Weight (g)	Handle length (mm)	
12299	600	320	5

**5 KICHEN AXE**

• ТОПОРИК КУХОННЫЙ • KÜCHENBEIL



- The whole metal part forged • Polished head
- Metal shank with PVC handle

Code	Weight (g)	Handle length (mm)	
12297	600	360	5

**6 HAND AXE**

• ТОПОР С КЛИНОМ • KEILAXT



**HRC** 46±2

- Hot-forged • Quenched blades • Coated and ground • Wooden handle

Code	Weight (g)	Handle length (mm)	
12313	1200	600	5
12321	2000	800	5

**7 HAMMER-AXES**

• ТОПОРЫ-КОЛУНЫ • HAMMERAXT



**HRC** 46±2

- Hot forged • Quenched blades • Coated and ground • Self-locking wooden handle

Code	Weight (g)	Handle length (mm)	
12325	2500	900	1
12340	4000	900	1

**8 SPLITTING WEDGES**

• КЛИНЫ ДЛЯ ДЕРЕВА • HOLZKEILE



**HRC** 46±2

- Hot-forged • Quenched blades • Made from C45 steel • Special shape facilitating wood splitting

Code	Weight (g)	
12300	1500	1
12302	2000	1
12303	3000	1





PROLINE

LAHTI PRO

MEGA

**JUCO**

OTHER BRANDS

ERDI

KLINGSPOR

EXPRESS

ACTION CAN

TRITON

VULCAN

PROLINE

LANTTI PRO

MEGA

JUCO

OTHER BRANDS

ERDI

KLINGSPOR

EXPRESS

ACTION CAN

TRYTON

VULCAN

**1 GARDEN SPADE**  
• ШТЫКОВАЯ ЛОПАТА • SPATEN GERADE



**HRC**  
32±2

• Blade hardness 32 ± 2 HRC • Riveted • Not assembled

Code	Dimensions (mm)	
12355	195 x 295	5

**5 SAND SHOVEL**  
• СОВКОВАЯ ЛОПАТА ДЛЯ ПЕСКА • SANDSCHAUFEL



**HRC**  
32±2

• Blade hardness 32 ± 2 HRC • Straight wooden handle

Code	Dimensions (mm)	Handle length (mm)	
12352	250 x 270	1000	5

**2 COAL SHOVEL**  
• СОВКОВАЯ ЛОПАТА • SPATEN GERADE



**HRC**  
32±2

• Blade hardness 32 ± 2 HRC • Not assembled • For shank Ø 38 mm

Code	Dimensions (mm)	
12356	290 x 340	5

**6 SAND SHOVEL**  
• СОВКОВАЯ ЛОПАТА ДЛЯ УГЛЯ • KOHLESCHAUFEL



**HRC**  
32±2

• Blade hardness 32 ± 2 HRC • Wooden handle with T holder

Code	Dimensions (mm)	Handle length (mm)	
12350	250 x 270	900	5

**3 SPADE STRAIGHT**  
• ШТЫКОВАЯ ПРЯМОУГОЛЬНАЯ ЛОПАТА • SPATEN GERADE GENIETET



**HRC**  
32±2

• Blade hardness 32 ± 2 HRC • Riveted • Wooden handle with T holder

Code	Dimensions (mm)	Handle length (mm)	
12351	195 x 290	900	5

**7 COAL SHOVELS**  
• СОВКОВЫЕ ЛОПАТЫ ДЛЯ УГЛЯ • KOHLESCHAUFEL



**HRC**  
32±2

• Blade hardness 32 ± 2 HRC • Wooden handle with DY holder

Code	Dimensions (mm)	Handle length (mm)	
12353	290 x 340	900	5
12327	235 x 295	900	5

**4 SPADE STRAIGHT**  
• ШТЫКОВАЯ ПРЯМОУГОЛЬНАЯ ЛОПАТА • SPATEN GERADE



**HRC**  
32±2

• Blade hardness 32 ± 2 HRC • Lightweight structure without riveting  
• Wooden handle with T holder

Code	Dimensions (mm)	Handle length (mm)	
12358	180 x 270	900	5

**8 COAL SHOVEL**  
• СОВКОВАЯ ЛОПАТА ДЛЯ УГЛЯ • KOHLESCHAUFEL



**HRC**  
32±2

• Blade hardness 32 ± 2 HRC • Wooden handle with T holder

Code	Dimensions (mm)	Handle length (mm)	
12298	235x295	900	5

## OTHER BRANDS

abrasive discs

brushes

buckets

floats

glues

levels

lines

mains testers

paint brushes

shovels

spades

spatulas

tapes

trowels

and many others

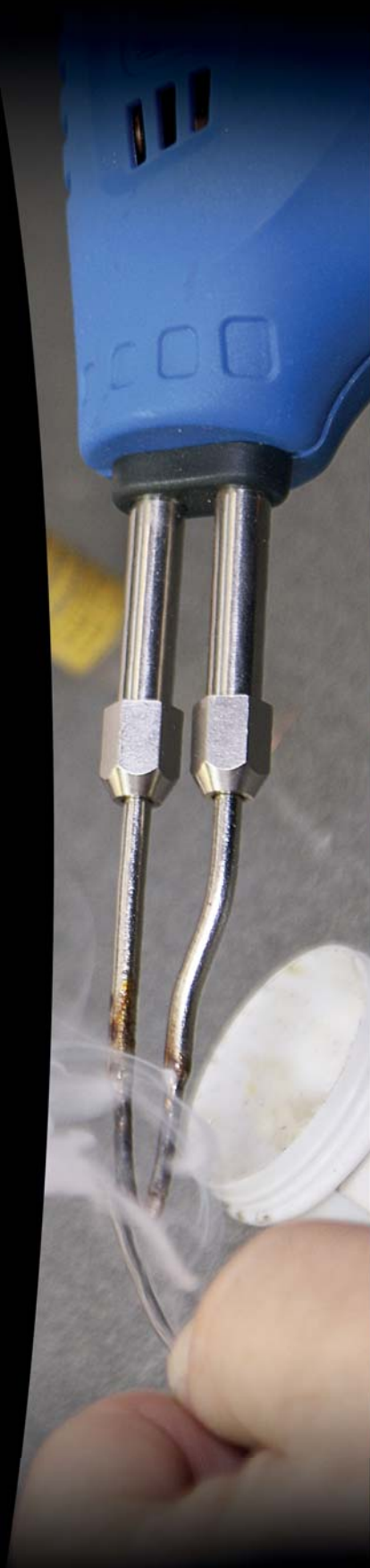

**1 T-SOCKET WRENCHES**

• КЛЮЧИ ТОРЦЕВЫЕ Т-ОБРАЗНЫЕ • STECKSCHLÜSSEL



• Forged • Hex socket

Code	Size (mm)	Length (mm)	
29065	8	190	50
29066	10	190	50
29067	13	190	50
29068	17	190	50
29069	19	190	50
29060	8	380	50
29061	10	380	50
29062	13	380	50
29063	17	380	50
29064	19	380	50

**2 REVERSIBLE BLADE SCREWDRIVER**

• ДВУХСТОРОННЯЯ ОТВЕРТКА • SCHRAUBENDREHER ZWEISEITIG



• Removable reversible bit: slotted 6 mm and Phillips PH 2 • Plastic handle • Bit length 100 mm

Code	Type	
10000L	reversible	30

**3 REVERSIBLE BLADE SCREWDRIVER**

• ДВУХСТОРОННЯЯ ОТВЕРТКА • SCHRAUBENDREHER ZWEISEITIG



• Removable reversible bit: slotted 6 mm and Phillips PH2 • Plastic handle • Bit length 35 mm

Code	Type	
10000K	reversible	40

**4 1000V ELECTRICIAN SCREWDRIVERS**

• ЭЛЕКТРОТЕХНИЧЕСКИЕ ОТВЕРТКИ • ELEKTROSCHRAUBENDREHER



**HRC** 58±2 **1000V** **Cr-V-Mo**

• Bit hardness 58 ± 2 HRC  
• Handle from non-slip material

Code	No. x L (mm)	
10536	PH0 x 100	30/120
10537	PH1 x 80	25/100
10538	PH2 x 100	20/80

**5 6 PCS 1000V ELECTRICIAN SCREWDRIVER SET**

• НАБОР ЭЛЕКТРОТЕХНИЧЕСКИХ ОТВЕРТОК 1000В – 6 ШТ. • ELEKTROSCHRAUBENDREHER 1000V - SET 6 STK.



**HRC** 58±2 **1000V** **Cr-V-Mo**

• Bit made from high-quality MbCrV steel resistant to wear and torsion • Bit hardness 58 ± 2 HRC • Handle made from high quality materials (ABS and thermoplast)  
• The set includes: slotted screwdrivers 3 x 100, 4 x 100, 5.5 x 125 mm; Pozidriv screwdrivers PZ1 x 80, PZ2 x 100 mm; voltage tester 200 - 250 V, 140 mm  
• Delivered in plastic box

Code	Quantity (pcs.)		
10599	6	x	10

**6 5 PCS 1000V ELECTRICIAN SCREWDRIVER SET**

• НАБОР ЭЛЕКТРОТЕХНИЧЕСКИХ ОТВЕРТОК 1000В – 5 ШТ. • ELEKTROSCHRAUBENDREHER 1000V - SET 5 STK.



**HRC** 58±2 **1000V** **Cr-V-Mo**

• Hardness 58 ± 2 HRC • The set includes: slotted screwdrivers 2.5 x 75, 3.5 x 100, 4.5 x 125 mm; Phillips screwdriver PH1 x 80 mm; voltage tester 200 - 250 V, 140 mm • Supplied in a case with a suspension

Code	Quantity (pcs.)		
10502	5	x	40

**7 6 PCS 1000V ELECTRICIAN SCREWDRIVER SET**

• НАБОР ЭЛЕКТРОТЕХНИЧЕСКИХ ОТВЕРТОК 1000В – 6 ШТ. • ELEKTROSCHRAUBENDREHER 1000V - SET 6 STK.



**HRC** 58±2 **1000V** **Cr-V-Mo**

• Bit made from high-quality MbCrV steel resistant to wear and torsion • Bit hardness 58 ± 2 HRC • Handle made from high quality materials (ABS and thermoplast)  
• The set includes: slotted screwdrivers 3 x 100, 4 x 100, 5.5 x 125 mm; Phillips screwdrivers PH1 x 80, PH2 x 100 mm; voltage tester 200 - 250 V, 140 mm  
• Delivered in plastic box

Code	Quantity (pcs.)		
10598	6	x	10

**8 6 PCS 1000V ELECTRICIAN SCREWDRIVER SET**

• НАБОР ЭЛЕКТРОТЕХНИЧЕСКИХ ОТВЕРТОК 1000В – 6 ШТ. • ELEKTROSCHRAUBENDREHER 1000V - SET 6 STK.



**HRC** 58±2 **1000V** **Cr-V-Mo**

• Hardness 58 ± 2 HRC • The set includes: slotted screwdrivers 2.5 x 75, 3.5 x 100, 4.5 x 125, 5.5 x 125 mm; Phillips screwdrivers PH1 x 80, PH2 x 100 mm • Supplied in a case with a suspension

Code	Quantity (pcs.)		
10503	6	x	30

### 1 6 PCS 1000V ELECTRICIAN SCREWDRIVER SET

- НАБОР ЭЛЕКТРОТЕХНИЧЕСКИХ ОТВЕРТОК 1000В – 6 ШТ.
- ELEKTROSCHRAUBENDREHER 1000V - SET 6 STK.



- Hardness 58 ± 2 HRC
- The set includes:
  - 10078** - slotted screwdrivers 3 x 100, 4 x 100, 5.5 x 125 mm; Pozidriv screwdrivers PZ1 x 80, PZ2 x 100 mm; voltage tester 200 - 250 V, 140 mm;
  - 10079** - slotted screwdrivers 3 x 100, 4 x 100, 5.5 x 125 mm; Phillips screwdrivers PH1 x 80, PH2 x 100 mm; voltage tester 200 - 250 V, 140 mm
- Delivered in a plastic box

Code	Quantity (pcs.)		
10078	6	x	10
10079	6	x	10

### 2 4 PCS 1000V ELECTRICIAN SCREWDRIVER SET

- НАБОР ЭЛЕКТРОТЕХНИЧЕСКИХ ОТВЕРТОК 1000В – 4 ШТ.
- ELEKTROSCHRAUBENDREHER 1000V - HEIMSET 4 STK.



- Hardness 58 ± 2 HRC
- The set includes:
  - slotted screwdrivers 3 x 100, 5.5 x 125 mm;
  - Phillips screwdriver PH2 x 100 mm;
  - voltage tester 200 - 250 V, 140 mm
- Supplied in a case with a suspension

Code	Quantity (pcs.)		
10541	4	x	40

### 3 5PCS 1000V ELECTRICIAN SCREWDRIVER SET

- НАБОР ЭЛЕКТРОТЕХНИЧЕСКИХ ОТВЕРТОК 1000В – 5 ШТ.
- ELEKTROSCHRAUBENDREHER 1000 V - AUTOSSET 5 STK.



- Hardness 58 ± 2 HRC
- The set includes:
  - slotted screwdrivers 3 x 100, 4 x 100;
  - 5.5 x 125 mm; Phillips screwdriver PH2 x 100 mm; voltage tester 6 - 24 V, with a clip
- Delivered in a case with a suspension

Code	Quantity (pcs.)		
10540	5	x	10

### 4 LCD MAINS TESTER

- ИНДИКАТОРНЫЙ ТЕСТЕР С ЖК ДИСПЛЕЕМ
- PRÜFSTIFT MIT LCD



- For AC and DC testing
- Voltage presence checks
- Voltage checks in zero and at grounding
- Checking specific voltage values in the display ranges 12 - 36 - 55 - 110 - 220 V
- Voltage detection through insulation
- Plastic bit and handle shield

Code	Range of measurements	Length (mm)		
10590	12 - 250 V	190	x	5/100

### 5 MAINS TESTERS

- ОТВЕРТКИ-ТЕСТЕРЫ • SPANNUNGSPRÜFER



- Durable plastic handle with a clip
- Shielded bit from CrV steel
- Conforms to PN-EN-ISO/IEC 17050-1:2005
- Delivered in bulk

Code	Range of measurements	Length (mm)	
10581	200 - 250 V	140	100/ 1200
10582	200 - 250 V	190	100/600

### 6 MAINS TESTER

- ТЕСТЕР НАПРЯЖЕНИЯ 220В И 380В • SPANNUNGSPRÜFER 220 V UND 380 V



- Universal tester for DC and AC voltage in ranges 200 - 260 V and 360 - 440 V

Code	Range of measurements		
10584	200 - 260 V and 360 - 440 V	x	36

### 7 FAZER BUZZER

- ОТВЕРТКИ ТЕСТЕР • SPANNUNGSPRÜFER



Checking positive, negative and ground



Checking the +12V line in a car



Checking circuit continuity



Checking Christmas lights



Voltage detection through insulation



Determining the order of wires in a bundle



Checking the chassis ground (-) line in a car



Checking fuses



- Length 175 mm
- Supplied in a foil pouch with a pendant

Code	Range of measurements		
10587	< 400 V	x	16 / 320

## 1 ADJUSTABLE WRENCHES

• КЛЮЧИ РАЗВОДНЫЕ • VERSTELLSCHLÜSSEL „FRANZOSE“

- Steel 45 • Heavy-duty • Furrowed jaws to ensure higher gripping force
- Knurled handle • Blackened head

Code	Size (mm)	
29635	35 x 200	10
29645	45 x 210	10
29655	55 x 270	5
29665	65 x 280	5



## 2 WOODEN TRY SQUARES

• ДЕРЕВЯННЫЕ СТОЛЯРНЫЕ УГОЛЬНИКИ • UNIVERSALWINKEL



Code	Length (mm)	
21053	300	20
21054	400	30
21055	500	30

## 3 WOODEN ADJUSTABLE BEVELS

• ДЕРЕВЯННЫЕ МАЛКИ • HOLZWINKEL

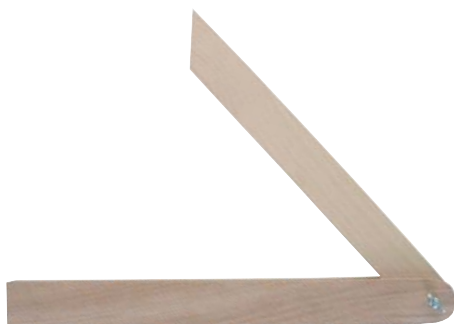

Code	Length (mm)	
21043	270	80
21044	400	60

## 4 UNIVERSAL RULER

• МЕТАЛЛИЧЕСКАЯ ЛИНЕЙКА • METALLMASS MIT SKALA



- Metal strip (cross section size 40\*1.8) with a two-sided metric graduation (tolerance  $\pm 1$  mm), painted graduation • Wooden profiled holder • Recommended for: building works, wallpaper and gypsumboard cutting

Code	Length (mm)	
21077	750	20

## 5 ALUMINIUM-METALIC PROTRACTORS

• УГОЛОМЕРЫ РАЗВОДНЫЕ • PLASTIK-METALL-WINKEL MIT SKALA



AL

- Aluminium beam (cross section size 77\*19) • One-sided protractor, fixed in the beam and graduated arm connection point, graduation 4\*90° (tolerance  $\pm 1^\circ$ ) with a dial • Metal arm (cross section size 30\*1.8) with a four-sided metric graduation (tolerance  $\pm 1$  mm), painted graduation

Code	Length (mm)	
21083	350	10
21085	500	10
21087	750	10

## 6 COMBINATION SQUARES

• УГОЛЬНИКИ МЕТАЛЛИЧЕСКИЕ • HOLZWINKELMASS

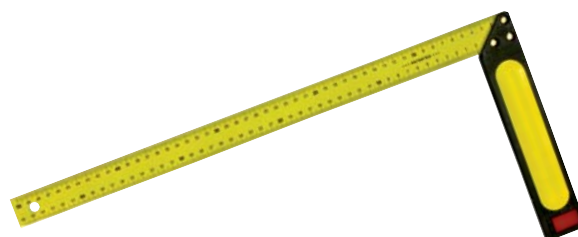

- Plastic beam (cross section size 40\*15) • Red holder on the beam to hang the square • Metal arm (cross section size 30\*1.8) with a two-sided painted metric graduation (tolerance  $\pm 1$  mm) on both edges

Code	Length (mm)	
21063	350	30
21065	500	30
21067	750	20
21069	1000	10

### 1 POLYURETHANE FLOATS

- ШТУКАТУРНЫЕ ПЕНОПЛАСТОВЫЕ ТЕРКИ
- STYROPHOR-GLÄTTKELLEN



- For trowelling traditional plasters

Code	Size (mm)	
61602	265 x 127	10
00105	317 x 170	10
61605	492 x 136	10
61607	691 x 136	10
61600	995 x 136	5

### 2 POLYURETHANE FLOAT

- ШТУКАТУРНАЯ КОНУСНАЯ ПЕНОПЛАСТОВАЯ ТЁРКА
- STYROPHOR-GLÄTTKELLE MIT SPITZE



- For trowelling traditional plasters
- Improved styrofoam quality, ensuring higher durability
- Spike at the front

Code	Size (mm)	
00107	320 x 180	10

### 3 POLYSTYRENE TROWELS WITH FELT

- ПОЛИСТИРОЛ ШПАТЕЛЬ С ВОЙЛОКОМ
- STYROPHOR-GLÄTTKELLE MIT FILZ, GESCHLOSSENER GRIFF



- For smoothing traditional plasters

Code	Size (mm)	Felt thickness (mm)	
61592	270 x 130	4	10
61593	270 x 130	8	10

### 4 POLYESTERENE FLOATS

- ШТУКАТУРНЫЕ ПЛАСТМАССОВЫЕ ГЛАДКИЕ ТЕРКИ
- PLASTIK-GLÄTTKELLEN GLATT



- For textured and mineral plaster
- Closed plastic handle

Code	Size (mm)	
61010	270 x 130	24
61017	400 x 130	10

### 5 POLYESTERENE FLOAT

- ШТУКАТУРНАЯ ПЛАСТМАССОВАЯ ГЛАДКА ТЁРКА
- PLASTIK-GLÄTTKELLE GLATT



- For textured and mineral plaster
- Open plastic handle

Code	Size (mm)	
00301	270 x 130	30

### 6 SPREADING POLYESTERENE FLOATS

- ШТУКАТУРНЫЕ ПЛАСТМАССОВЫЕ ЗУБЧАТЫЕ ГЛАДКИЕ ТЁРКИ
- PLASTIK-GLÄTTKELLEN GEZAHNT



- Rectangular teeth for spreading lue
- Closed plastic handle

Code	Size (mm)	Tooth (mm)	
61014	270 x 130	4 x 4	10
61012	270 x 130	6 x 6	10
61013	270 x 130	8 x 8	10
61015	270 x 130	10 x 10	10
61016	270 x 130	12 x 12	10

### 7 SPREADING POLYESTERENE FLOATS

- ШТУКАТУРНЫЕ ПЛАСТМАССОВЫЕ ЗУБЧАТЫЕ ГЛАДКИЕ ТЁРКИ
- PLASTIK-GLÄTTKELLEN GEZAHNT



- Rectangular teeth for spreading glue
- Open plastic handle

Code	Size (mm)	Tooth (mm)	
00300	270 x 130	4 x 4	10
00302	270 x 130	6 x 6	30
00303	270 x 130	8 x 8	30
00304	270 x 130	10 x 10	30
00299	270 x 130	12 x 12	10

### 8 RUBBER FACE FLOATS

- ШТУКАТУРНЫЕ ПЛАСТМАССОВЫЕ ТЁРКИ С РЕЗИНОВОЙ ПОДКЛАДКОЙ
- PLASTIK-GLÄTTKELLEN MIT GUMMI



- For grouting during tilelaying works

Code	Size (mm)	Rubber thickness (mm)	
61311	270 x 130	4	10
61312	270 x 130	8	10

### 9 SPARE RUBBER PADS

- РЕЗИНОВЫЕ ПОДКЛАДКИ ДЛЯ ШТУКАТУРНЫХ ТЕРОК
- ERSATZGUMMIS



- Spare rubber pads for plastic floats

Code	Size (mm)	Thickness (mm)	
61210	270 x 130	4	30
61211	270 x 130	8	15

**1 RUBBER FACE FLOATS**

- ШТУКАТУРНАЯ ПЛАСТМАССОВАЯ ТЕРКА
- PLASTIK-GLÄTTKELLE MIT GUM MIBESCHICHTUNG



- For grouting • Rubber base • Rubber truncated at sides

Code	Size (mm)	
00325	240 x 85	30

**4 SPONGE FACE FLOATS**

- ШТУКАТУРНЫЕ ПЛАСТМАССОВЫЕ ТЕРКИ С ГУБКОЙ
- PLASTIK-GLÄTTKELLEN MIT SCHAUMSTOFF



- Thin hard sponge - for smoothing traditional plaster
- Thick soft sponge - for tile washing after grouting during tiling works

Code	Size (mm)	Sponge Type	Thickness (mm)	
61005	270 x 130	hard & thin	30	10
61007	270 x 130	soft & thick	30	10
• with 10 mm rubber sponge for gypsum works				
61313	260 x 120	rubber	10	10

**7 FLOAT WITH NEEDED FABRIC**

- ТЕРКА С ВОЛОКНОМ • KUNSTSTOFF-GLÄTTKELLE MIT AUSWECHSELBAREM FASERSTOFF



- Plastic ps • Black (rough) and white (soft) non-woven fabric • fabric fixed with velcro
- For cleaning (black) and polishing (white) of ceramic tiles • The set includes: float, black and white non-woven fabric

Code	Size (mm)	
KU0360	250 x 120	6

**2 FELT FACE FLOATS**

- ШТУКАТУРНЫЕ ПЛАСТМАССОВЫЕ ТЕРКИ С ВОЙЛОЧНОЙ ПОДКЛАДКОЙ • PLASTIK-GLÄTTKELLEN MIT FILZ



- For smoothing traditional plasters

Code	Size (mm)	Felt thickness (mm)	
61001	270 x 130	4	10
61003	270 x 130	8	10

**5 SPARE SPONGE PADS**

- ЗАПАСНЫЕ ГУБКИ ДЛЯ ШТУКАТУРНЫХ ПЛАСТМАССОВЫХ ТЕРОК
- ERSATZSCHAUMSTOFF



- Spare sponge pads for plastic floats

Code	Size (mm)	Sponge Type	Thickness (mm)	
61216	270 x 130	hard & thin	30	10
61215	270 x 130	soft & thick	30	15

**8 2 PCS. BLACK AND WHITE FABRIC SET**

- ЗАМЕННОЕ ВОЛОКНО - КОМПЛЕКТ 2 ШТ.
- FASERSTOFF WEISS UND SCHWARZ ALS ERSATZ ZUR GLÄTTKELLE - SET 2 STK.



- Set of 2: black (rough) and white (soft) non-woven fabric • For cleaning (black) and polishing (white) of ceramic tiles

Code	Size (mm)	
KU0361	250 x 120	5

**3 SPARE FELT PADS**

- ВОЙЛОЧНЫЕ ПОДКЛАДКИ ДЛЯ ШТУКАТУРНЫХ ТЕРОК
- ERSATZFILZE



- Spare felt pads for plastic floats

Code	Size (mm)	Thickness (mm)	
61201	270 x 130	4	30
61203	270 x 130	8	20

**6 PLASTIC FLOAT WITH INCISED SPONGE**

- ПЛАСТМАССОВАЯ ТЕРКА С НАРЕЗАННОЙ ГУБКОЙ
- KUNSTSTOFF - GLÄTTKELLE MIT EINGESCHNITTENEM SCHAUMSTOFF



- Plastic PS • sponge thickness: 30mm
- Sponge incised lengthwise and crosswise the float • For tile washing after grouting

Code	Size (mm)	
KU0387	275 x 135	12

**9 PLASTIC HAND SANDER**

- ШТУКАТУРНАЯ ПЛАСТИКОВАЯ ТЕРКА „РАШПИЛЬ“
- KUNSTSTOFF-GLÄTTKELLE MIT EINGESCHNITTENEM SCHAUMSTOFF

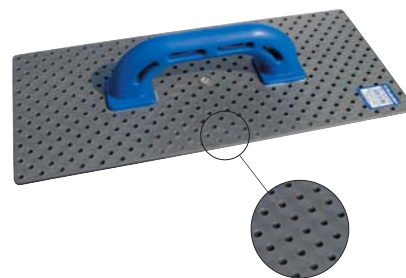

- Plastic rasp on a float

Code	Size (mm)	
00341	380 x 160	30



### 1 RASP FLOAT

- ШТУКАТУРНАЯ ПЛАСТИКОВАЯ ТЕРКА „РАШПИЛЬ“
- SCHLEIFKELLE MIT SCHLEIFBELAG



- Plastic rasp on a plastic float

Code	Size (mm)	
00321	400 x 180	10

### 2 RASP FLOATS

- ШТУКАТУРНЫЕ ПЛАСТМАССОВЫЕ ГЛАДКИЕ ТЕРКИ СО СМЕННЫМ РАШПИЛЕМ • SCHLEIFKELLE MIT AUSWECHSELBAREM SCHLEIFBELAG



- Replaceable metal rasp

Code	Size (mm)	
61315	270 x 130	15
00322	400 x 160	10

### 3 REPLACEABLE INSET WITH RASP FLOAT

- СМЕННЫЙ РАШПИЛЬ • ERSATZSCHLEIFBELAG FÜR SCHLEIFKELLE



- Metal rasp - replaceable float pad 00322

Code	Size (mm)	
00323	400 x 160	10

### 4 ANGULAR TROWEL GRATE

- ШТУКАТУРНАЯ УГЛОВАЯ ПЛАСТИКОВАЯ ТЕРКА „РАШПИЛЬ“
- SCHLEIFKELLE



- Angular metal rasp 90°

Code	Size (mm)	
61316	270	15

### 5 PLASTIC HAND SANDERS

- ШТУКАТУРНЫЕ ПЛАСТМАССОВЫЕ ГЛАДКИЕ ТЕРКИ С КРЕПЛЕНИЕМ • PLATIKKELLEN FÜR SCHLEIFPAPIER UND SCHLEIFNETZE



- With rubber base
- Metal handles fixed with wing nuts

Code	Size (mm)	
61008	230 x 80	40
61009	215 x 100	30

### 6 PLASTIC HAND SANDER

- ПЛАСТИКОВЫЙ БРУСОК-ДЕРЖАТЕЛЬ ДЛЯ АБРАЗИВНОЙ БУМАГИ • PLATIKKELLE FÜR SCHLEIFPAPIER UND SCHLEIFNETZE



- With rubber base
- Spring snap-on handles

Code	Size (mm)	
00306	210 x 105	30

### 7 STEEL PLASTERING FLOAT

- ШТУКАТУРНЫЕ НЕРЖАВЕЮЩИЕ ГЛАДИЛКИ
- STAHLKELLEN RECHTECKIG



STAINLESS

- Stainless steel • For gypsum works (gypsum plaster and finishing coats, textured plaster)
- Closed plastic handle

Code	Size (mm)	
61713	380 x 130	10
61716	480 x 130	10

### 8 STEEL PLASTERING FLOATS

- ШТУКАТУРНЫЕ НЕРЖАВЕЮЩИЕ ГЛАДИЛКИ
- STAHLKELLEN RECHTECKIG



STAINLESS

- Stainless steel • Closed wooden handle

Code	Size (mm)	
61610	380 x 130	10
61620	480 x 130	10
61625	580 x 130	18
61626	680 x 130	18

### 9 STEEL PLASTERING TROWEL

- НЕРЖАВЕЮЩАЯ ГЛАДИЛКА • STAHLKELLE RECHTECKIG

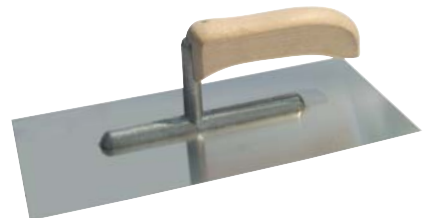

STAINLESS

- Stainless steel • Aluminium support
- Open wooden handle

Code	Size (mm)	
61650	270 x 130	24

**1 SMOOTH STAINLESS TROWEL**

- ШТУКАТУРНАЯ НЕРЖАВЕЮЩАЯ ГЛАДИЛКА
- VENEZIANISCHE EDELSTAHL-KELLE

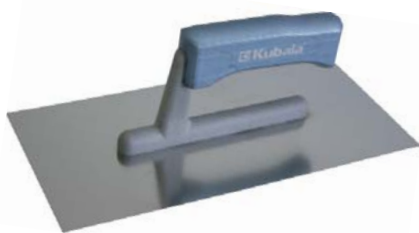

STAINLESS

- Stainless, acid-proof steel • Thick ness: 0.65mm • Wooden handle on an aluminium support • For making floors, applying mortars, adhesives and gypsum finishing coats

Code	Size (mm)	
KU0414	270 x 130	10

**2 SHARP GROUND STEEL TROWEL**

- СТАЛЬНАЯ „ОСТРАЯ“ ГЛАДИЛКА • STAHLKELLE SCHARF GLATT



CARBON

- Steel - thickness: 1.2mm
- Wooden handle on an aluminium support
- For floor making

Code	Size (mm)	
KU0421	500 x 90	20

**3 SMOOTH STAINLESS TROWEL**

- НЕРЖАВЕЮЩАЯ ГЛАДИЛКА • VENEZIANISCHE EDELSTAHL-KELLE



STAINLESS

- Stainless, acid-proof steel
- Thickness: 0.7mm • Two-component plastic handle on an aluminium support • Rounded corners • Ground and polished, for gypsum stucco

Code	Size (mm)	
KU0458	200 x 80	10

**4 SMOOTH STAINLESS CONIC TROWEL**

- НЕРЖАВЕЮЩАЯ ГЛАДИЛКА
- EDELSTAHL-KELLE „KEGELFÖRMIG“



STAINLESS

- Stainless, acid-proof steel • Thickness: 0.3mm • Two-component plastic handle on an aluminium support • For applying decorative indoor plasters

Code	Size (mm)	
KU0499	230 x 70	10

**5 STAINLESS PLASTERING TROWEL**

- ШТУКАТУРНАЯ НЕРЖАВЕЮЩАЯ ГЛАДИЛКА
- STAHLKELLE RECHTECKIG



STAINLESS

- Stainless steel • For gypsum works (gypsum plaster and finishing coats, textured plaster)
- Open plastic handle

Code	Size (mm)	
61700	270 x 130	30

**6 STEEL SPREADING TROWELS**

- ШТУКАТУРНЫЕ НЕРЖАВЕЮЩИЕ ЗУБЧАТЫЕ ГЛАДИЛКИ
- STAHLKELLEN GEZAHNT



STAINLESS

- Stainless steel • Closed wooden handle
- Rectangular teeth • For adhesive application during tiling works (tooth 6 x 6 and 8 x 8), for laying wood floors, for spreading mortar (tooth 10 x 10)

Code	Size (mm)	Tooth (mm)	
61612	380 x 130	8 x 8	10
61613	380 x 130	10 x 10	10
61621	480 x 130	6 x 6	10
61622	480 x 130	8 x 8	10
61623	480 x 130	10 x 10	10

**7 STEEL SPREADING TROWELS**

- ШТУКАТУРНЫЕ НЕРЖАВЕЮЩИЕ ЗУБЧАТЫЕ ГЛАДИЛКИ
- STAHLKELLEN GEZAHNT

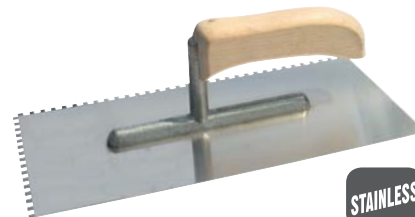

STAINLESS

- Stainless steel • Aluminium support • Open wooden handle • Rectangular teeth • For adhesive application during tiling works (tooth 6 x 6 and 8 x 8), for laying wood floors (tooth 4 x 4), for spreading mortar (tooth 10 x 10 and 12 x 12)

Code	Size (mm)	Tooth (mm)	
61651	270 x 130	4 x 4	24
61652	270 x 130	6 x 6	24
61653	270 x 130	8 x 8	24
61654	270 x 130	10 x 10	24
61655	270 x 130	12 x 12	24

**8 STEEL SPREADING TROWEL**

- НЕРЖАВЕЮЩАЯ ГЛАДИЛКА, ЗУБЧАТАЯ
- STAHLKELLEN GEZAHNT



STAINLESS

- Stainless, acid-proof steel • Thickness: 0.65mm • Two-component plastic handle on an aluminium support • For spreading adhesive mortars • Slanted tooth 8mm wide

Code	Size (mm)	
KU0487	270 x 130	10

**9 STEEL SPREADING TROWELS**

- ШТУКАТУРНЫЕ НЕРЖАВЕЮЩИЕ ГЛАДИЛКИ
- STAHLKELLEN GEZAHNT



STAINLESS

- Stainless steel • Open plastic handle
- Rectangular teeth • For adhesive application during tiling works (tooth 6 x 6 and 8 x 8), for laying wood floors (tooth 4 x 4), for spreading mortar (tooth 10 x 10 and 12 x 12)

Code	Size (mm)	Tooth (mm)	
61704	270 x 130	4 x 4	30
61706	270 x 130	6 x 6	30
61708	270 x 130	8 x 8	30
61710	270 x 130	10 x 10	30
61712	270 x 130	12 x 12	30

**1 PLASTERING TROWELS**

- КЕЛЬМЫ КАМЕНЩИКА ТРАПЕЦИДАЛЬНЫЕ
- TRAPEZKELLEN



STAINLESS

- Stainless steel
- Non-slip two-component handle

Code	Size (mm)	
<b>• Wide</b>		
61673	140 x 110 x 90	30
61674	160 x 110 x 90	30
61675	180 x 120 x 90	30
<b>• Narrow</b>		
61676	140 x 80 x 35	30
61677	160 x 90 x 40	30
61678	180 x 85 x 65	30

**2 BRICK TROWELS**

- КЕЛЬМЫ КАМЕНЩИКА ТРАПЕЦИДАЛЬНЫЕ
- TRAPEZKELLEN

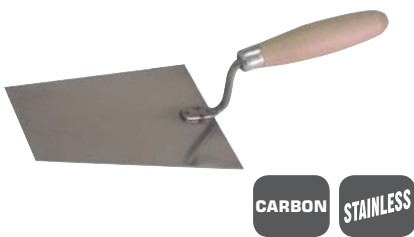

CARBON

STAINLESS

- Wooden handle

Code	Size (mm)	
<b>• Stainless steel</b>		
61773	130 x 105 x 80	50
61776	160 x 130 x 80	50
61778	180 x 155 x 80	30
<b>• Carbon steel</b>		
61733	130 x 90 x 75	50
61736	160 x 115 x 75	50
61738	180 x 140 x 75	50
61739	200 x 165 x 75	50

**3 STAINLESS TRAPEZOIDAL TROWELS**

- КЕЛЬМЫ КАМЕНЩИКА ТРАПЕЦИДАЛЬНЫЕ
- TRAPEZKELLEN



STAINLESS

- Stainless, acid-proof steel
- Thickness: 1.0mm
- Wooden handle
- For bricklaying and plastering works

Code	Size (mm)	
KU0808	115 x 160 x 90	20
KU0810	120 x 180 x 90	20
KU0901	80 x 145 x 55	20

**4 POINTED BRICK TROWELS**

- КЕЛЬМЫ КАМЕНЩИКА ТРЕУГОЛЬНЫЕ
- MAURERKELLEN DREIECKIG



STAINLESS

- Stainless steel
- Non-slip two-component handle

Code	Size (mm)	
61670	190	30
61672	210	30

**5 POINTING BRICK TROWELS**

- КЕЛЬМЫ КАМЕНЩИКА ТРЕУГОЛЬНЫЕ
- MAURERKELLEN DREIECKIG



CARBON

STAINLESS

- Equilateral
- Wooden handles

Code	Size (mm)	
<b>• Stainless steel</b>		
61771	180	25
61770	200	30
<b>• Carbon steel</b>		
61728	180	50
61720	200	50
61722	220	50

**6 STEEL TRIANGULAR TROWEL**

- КЕЛЬМА КАМЕНЩИКА ТРЕУГОЛЬНАЯ
- MAURERKELLEN DREIECKIG



CARBON

- Ground steel
- 1.2 mm thick
- Equilateral
- Wooden handles

Code	Size (mm)	
KU0804	200 x 190	10

**7 TRIANGULAR TROWEL**

- КЕЛЬМА КАМЕНЩИКА ТРЕУГОЛЬНАЯ
- MAURERKELLEN DREIECKIG



STAINLESS

- Stainless, acid-proof steel
- Thickness: 1.0mm
- Wooden handle
- For bricklaying and plastering works
- Equilateral

Code	Size (mm)	
KU0807	200 x 190	10

**8 TILE TROWELS**

- КЕЛЬМЫ ШТУКАТУРНЫЕ
- STUCKATEURKELLE



STAINLESS

- Stainless steel
- Non-slip two-component handle

Code	Size (mm)	
61680	40 x 110	30
61681	60 x 110	30
61682	80 x 110	30
61683	100 x 100	30

**9 STUCCO TROWELS**

- КЕЛЬМЫ ШТУКАТУРНЫЕ
- STUCKATEURKELLE



STAINLESS

- Stainless steel
- Wooden handle

Code	Size (mm)	
61765	50 x 100	50
61766	60 x 100	50
61768	80 x 100	50

**1 STAINLESS STUCCO TROWELS**

• КЕЛЬМЫ ШТУКАТУРНЫЕ • STUCKATEURKELLE

**STAINLESS**

- Stainless, acid-proof steel • Thickness: 0.8mm • Wooden handle • For stucco works (gypsum)

Code	Size (mm)	☐
KU0902	60	20
KU0903	80	20
KU0904	100	20

**4 BRICK JOINTER TROWELS**

• РАСШИВКИ ШТУКАТУРНЫЕ • FUGENKELLEN

**CARBON**

- Carbon steel • Wooden handle

Code	Size (mm)	☐
61748	8	50
61740	10	50
61742	12	50

**7 WALL SCRAPERS**

• ШПАТЕЛЯ • SPACHTELN

**STAINLESS**

- Stainless steel • Plastic handle

Code	Size (mm)	☐
61754	40	25
61756	60	25
61758	80	25
61750	100	25

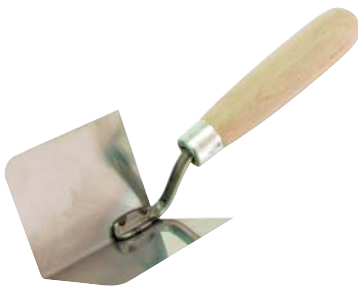
**2 CORNER TROWELS**• КЕЛЬМЫ ШТУКАТУРНЫЕ ДЛЯ ВНУТРЕННИХ УГЛОВ  
• WINKELKELLEN FÜR INNENKANTEN**STAINLESS**

- Stainless steel • Wooden handle

Code	Size (mm)	☐
61760	80 x 60	50
61761	120 x 60	50

**5 BRICK TROWELS „YTONG” TYPE**

• ШТУКАТУРНЫЕ КОВШИ • KELLE „YTONG”

**CARBON**

- Carbon steel • Wooden handle

Code	Size (mm)	☐
61711	100	10
61714	200	10
61715	240	10
61717	300	10

**8 PLASTERING SPATULAS**

• ШПАТЕЛЯ • SPACHTELN FÜR FEINPUTZ

**STAINLESS**

- Stainless steel
- For applying gypsum finishing coat
- Plastic handle

Code	Size (mm)	☐
61100	150	150
61101	200	100
61102	250	100
61103	300	50
611035	350	50
61110	440	50
61104	450	50
61105	600	20

**3 CORNER TROWELS**• КЕЛЬМЫ ШТУКАТУРНЫЕ ДЛЯ ВНЕШНИХ УГЛОВ  
• WINKELKELLEN FÜR AUSSENKANTEN**STAINLESS**

- Stainless steel • Wooden handle

Code	Size (mm)	☐
61762	80 x 60	50
61763	120 x 60	50

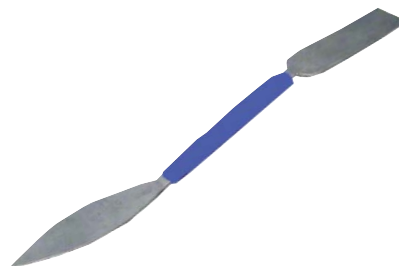
**6 UNIVERSAL STRIPPING KNIVES**• УНИВЕРСАЛЬНЫЕ СТАЛЬНЫЕ ШПАТЕЛИ  
• UNIVERSALSPACHTEL**CARBON**

- Carbon steel • Thickness: 1.2mm • Plastic handle • For grouting and painting works

Kód	Width (mm)	☐
KU0598	16	50
KU0599	24	50

**9 WALL SCRAPERS**

• ШПАТЕЛЯ • SPACHTELN GLATT

**STAINLESS**

- Stainless steel • Wooden handle

Code	Size (mm)	☐
61781	180	50
61782	250	50

**1 SPREADING SPATULAS**

• ЗУБЧАТЫЕ ШПАТЕЛЯ • SPACHTELN GEZAHNT

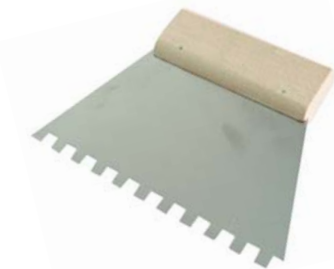

STAINLESS

• Stainless steel • Wooden handle

Code	Size (mm)	Tooth (mm)	
61787	180	4 x 4	50
61783	180	6 x 6	50
61784	180	8 x 8	50
61788	180	10 x 10	50
61789	250	4 x 4	50
61785	250	6 x 6	50
61786	250	8 x 8	50
61790	250	10 x 10	50

**2 SPREADING SPATULAS**

• ЗУБЧАТЫЕ ШПАТЕЛЯ • SPACHTELN GEZAHNT FÜR FEINPUTZ



STAINLESS

• Stainless steel • For adhesive application during tiling works • Plastic handle

Code	Size (mm)	Tooth (mm)	
61106	150	6 x 6	10
61107	150	8 x 8	10
61108	250	6 x 6	10
61109	250	8 x 8	10

**3 JOINTING RUBBER SPATULAS**

• РЕЗИНОВЫЕ ШПАТЕЛЯ • FUGENSACHTELN AUS GUMMI



• Wooden frame  
• For grouting wall and floor tiles

Code	Size (mm)	
61501	150	160
61503	200	100
61502	250	100
61504	300	80

**4 RUBBER STRIPPING KNIFE**

• РЕЗИНОВЫЙ ШПАТЕЛЬ • GUMMISACHTELN ZUM VERFUGEN UND ABZIEHEN VON WASSER

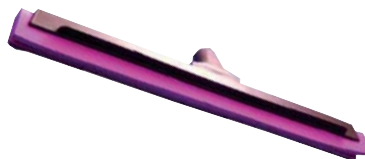

• Rubber • Thickness: 7mm (double) • Plastic handle with an opening to put a stick for grouting and water removal from large areas

Code	Length (mm)	
KU0607	440	20

**5 4PCS PLASTIC JAPANESE SCRAPERS**

• НАБОР ЯПОНСКИХ ШПАТЕЛЕЙ – 4 ШТ.  
• JAPANISCHE SPACHTELN SET 4 TLG.



• Plastic • 4 putty knives with width: 5, 7.5, 10, 12 cm

Code	Quantity (pcs.) in the set	
01624	4	150

**6 STEEL JAPANESE SCRAPERS**

• ЯПОНСКИЕ ШПАТЕЛИ • JAPANISCHE SPACHTELN SET 4 TLG.

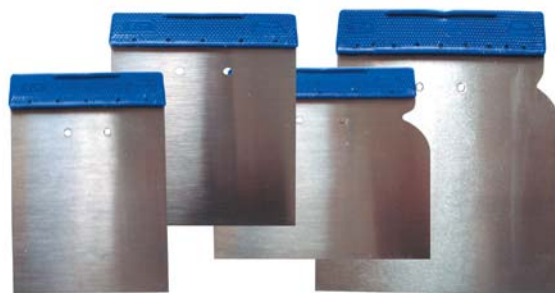

• Steel • Plastic handles • 4 palette knives with width: 5, 8, 10, 12 cm

Code	Quantity (pcs.) in the set	
01625	4	100

**7 UNIVERSAL RUBBER STRIPPING KNIVES**

• ПЛАСТМАССОВЫЕ УНИВЕРСАЛЬНЫЕ ШПАТЕЛИ • PLASTIKWERKZEUG



• Plastic PS • For spreading adhesive mortar  
• Multipurpose thanks to different shapes and sizes of teeth

Code	Size (mm)	Type	
KU0706	175 x 130	toothed	50
KU0708	135 x 90	toothed mini	50

**8 UNIVERSAL STRIPPING KNIVES**

• МАСТЕРКИ ПЛАСТИКОВЫЕ • FÜR FUGEN FORM „K“



PE

• Plastic PE • For joint smoothing (black), for silicone (white)

Code	Type	
KU1614	for joints	100
KU1628	for silicone	100

**1 PLASTER STRIPPING TOOL**

• ТЕРКА ДЛЯ СНЯТИЯ ШТУКАТУРКИ • AUSGLEICHBRETT FÜR PUTZNIVELLIERUNG

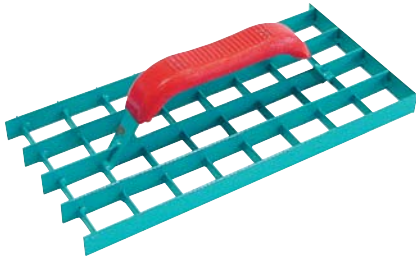

• Steel • Steel handle coated with plastic

Code	Size (mm)	
01401	290 x 150	15

**2 WOODEN TROWEL SCRAPER FOR PLASTERS**

• ТЕРКА ДЛЯ СНЯТИЯ ШТУКАТУРКИ • ТЕРКА ДЛЯ СНЯТИЯ ШТУКАТУРКИ



• Wooden • Closed handle • Steel blades

Code	Size (mm)	
01424	400	10

**3 ALUMINIUM TROWEL SCRAPER FOR PLASTERS**

• АЛЮМИНИЕВАЯ ТЕРКА ДЛЯ СНЯТИЯ ШТУКАТУРКИ • AUSGLEICHBRETT FÜR PUTZNIVELLIERUNG

**AL**

• Aluminium • Closed handle • Steel blades

Code	Size (mm)	
01425	450	10

**4 MASON'S PAN**

• ЧЕРПАК КАМЕНЩИКА • MÖRTELSCHÖPFER



• Stalowy • Wooden handle • For bricklaying and plastering works

Code	Diameter (mm)	
61805	173	50

**5 METAL SCOOP**

• МЕТАЛЛИЧЕСКИЙ ЧЕРПАК • METALLSCHÖPFER VERZINKT



• Metal, galvanised • For bricklaying and plastering works

Code	Diameter (mm)	
KU1510	170	80

**6 PLASTIC CONTAINER**

• ПЛАСТМАССОВАЯ ЕМКОСТЬ • GIPSBECHER



• Plastic • For gypsum mixing

Code	Volume (l)	
KU1516	0,5	20

**7 PLASTIC CONTAINER**

• ПЛАСТМАССОВАЯ ЕМКОСТЬ • GIPSBECHER

**PP**

• Plastic PP support with a handle • Soft rubber container for gypsum mixing • The set includes: support and container

Code	Volume (l)	
KU1518	0.5	20

**8 VENTING ROLLERS**

**FOR READY-MIXED PLASTERS**

• ВАЛИКИ ДЛЯ САМОВЫРАВНЯЮЩИХСЯ ПОВЕРХНОСТЕЙ • GERÄT ZUM ENTLÜFTEN VON ESTRICH



• Roller and spikes made from plastic • Plastic handle with an opening form the telescopic stick

Code	Size (mm)	Height of spikes (mm)	
01618	230 x 75	14	15
01621	230 x 110	28	10

**9 TILE SPONGE**

• ГУБКА ДЛЯ ГЛАЗУРИ • FLIESEN-SCHWAMM



• Dense sponge • For cleaning tiles after grouting

Code	Size (mm)	
KU1680	160 x 110 x 60	

**10 HARD POROUS SPONGE**

• ГУБКА ПОРИСТАЯ ТВЕРДАЯ • HARTER PORÖSER SCHWAMM



• Porous sponge with connected pores • Connected pores ensure increased sponge absorbency and better water drainage • For cleaning tiles after grouting

Code	Size (mm)	
KU1689	160 x 110 x 60	

### 1 CONSTRUCTION SUPPORT AUTOMATIC

• СТРОИТЕЛЬНЫЕ РАСПОРЫ • TÜRSpanNER



- Adjustable length • Automated mechanism
- For installing frames and other components not requiring high loads • It is recommended to use in a vertical position • Sold in sets: one tube and two feet

Code	Size (mm)	
KU1829	from 670 to 970	6

### 2 NAIL WITH PRESSER

• ГВОЗДЬ С ПРИХВАТОМ • PUTZHAKEN AUS STAHL



CARBON

- Steel • For bricklaying and plastering works

Code	Length (mm)	
KU1643	150	50

### 3 ANGULAR CUTTING SUPPORT

• УГЛОВОЙ ПРИБОР ДЛЯ РЕЗКИ • WINKELSAGEVORRICHTUNG FÜR LEICHTBETONSTEINE

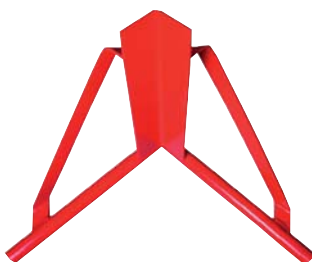

CARBON

- Auxiliary cutter for cellular concrete blocks

Code	Size (mm)	
KU1709	270 x 270 x 270	10

### 4 GROOVING DEVICE

• ПРИБОР ДЛЯ РИФЛЕНИЯ • VORRICHTUNG FÜR DAS BERIEFEN VON LEICHTBETONSTEINE



CARBON

- Metal • For making grooves for the electrical system in cellular concrete blocks

Code	Groove width (mm)	
KU1710	18	10

### 5 NYLON BRICKLAYER LINE

• НЕЙЛОНОВАЯ ЛЕСКА КАМЕНЩИКА • MAURERSCHNUR



- Nylon • Random colour

Code	Length (mm)	Diameter (mm)	
61801	100	1.0	120

### 6 3 PCS UNIVERSAL LINES SET

• ШНУР УНИВЕРСАЛЬНЫЙ, НАБОР - 3ШТ. • UNIVERSALSCHNUR SET 3STK.



- Braided • Polypropylene string • Set of 3 in different colours • The permissible length is up to  $\pm 5\%$  of the rated length

Code	Length (m)	Diameter (mm)	
60995	50	2.0	40
60996	100	2.0	24

### 7 POLYPROPYLENE BRICKLAYER LINES

• ШНУРЫ КАМЕНЩИКА ПОЛИПРОПИЛЕНОВЫЕ • MAURERSCHNÜRE



- Braided • Polypropylene rope • Orange
- High abrasion resistance • Don't absorb water or other liquids • Permissible length difference  $\pm 5\%$  of the rated length

Code	Length (mm)	Diameter (mm)	
61802	50	1.7	60
61803	100	1.7	30

### 8 POLYPROPYLENE BRICKLAYER LINES

• ШНУРЫ КАМЕНЩИКА ПОЛИПРОПИЛЕНОВЫЕ • MAURERSCHNÜR



- Braided • Polypropylene rope • Yellow
- High abrasion resistance • Don't absorb water or other liquids • Permissible length difference  $\pm 5\%$  of the rated length

Code	Diameter (mm)	Length (m)	
61792	1.7	50	60
61793	1.7	100	30

### 9 JUTE LINES

• ПЕНЬКОВЫЕ КАНАТЫ • JUTESEILE



- Natura fibre, jute, rope, twisted

Code	Diameter (mm)	Length (m)	
60811	10	10	21
60812	10	20	10
60821	12	10	13
60822	12	20	8
60831	14	10	10
60832	14	20	6
60842	16	20	4
60843	16	30	3
60862	20	20	3

### 1 POLYPROPYLENE BRAIDED LINES

- КАНАТЫ ПЛЕТЕННЫЕ ПОЛИПРОПИЛЕНОВЫЕ
- POLYPROPYLEN-FLECHTSEIL



- Rope with a twisted core in polypropylene yarn braid • Sold by linear metres of the total rope length on the reel • Random colour

Code	Diameter (mm)	Length (m)	
60903	3	600	57600
60904	4	400	38400
60905	5	300	28800
60906	6	300	1800
60908	8	300	9600
60910	10	200	6400
60912	12	150	3600
60914	14	100	3200
60916	16	80	2560
60918	18	60	1920
60920	20	50	1200

### 2 RUBBER LINES

- РЕЗИНОВЫЕ ШНУРЫ • GUMMISEILE



- Rope with a rubber core in polypropylene yarn braid • Sold by linear metres of the total rope length on the reel

Code	Diameter (mm)	Length (m)	
60950	4	200	38400
60956	6	150	14400
60958	8	100	9600
60960	10	100	6000

### 3 PLASTIC STRINGS

- ШНУРЫ ПОЛИПРОПИЛЕНОВЫЕ • KUNSTSTOFFSCHNÜRE



- Polypropylene twisted string • The string diameter can be different at its length • The permissible packing length is up to  $\pm 10\%$  of the rated length

Code	Length (m)	
60972	200	45
60973	300	40
60975	500	20
60976	1000	12
60978	2000	1

### 4 JUTE STRINGS

- ШНУРЫ ПЕНЬКОВЫЕ УПАКОВОЧНЫЕ • PACKSCHNÜRE AUS JUTE



- Natura fibre, jute string, twisted
- Diameter  $\varnothing 2.5 \text{ mm} \pm 0.2 \text{ mm}$

Code	Weight (g)	
60983	100 $\pm 10\%$	126
60984	250 $\pm 10\%$	50

### 5 TWINES

- ШПАГАТЫ • PECHDRAHT VERSTÄRKT



- Diameter  $\varnothing 0.5 \text{ mm} \pm 0.1 \text{ mm}$  • Made from a mix of linen and hemp fibres

Code	Weight (g)	
60991	100 $\pm 10\%$	112
60992	250 $\pm 10\%$	60

### 6 BUILDERS WATERING BRUSH

- ЩЕТКА КАМЕНЩИКА • MAURERBÜRST



- Synthetic bristle plus coconut fibre
- Wooden handle • No ferrule

Code	Size (mm)	
43038	180 x 60	20

### 7 BRUSH SWEEPER

- ЩЕТКА-МЕТЛА ДЛЯ УЛИЦЫ • STSTRASSENBESEN



- Possibility to buy a handle 12933
- PET bristle 60mm long • Waxed beechwood frame with the so-called chimney

Code	Width [mm]	
32074	400	20

### 8 STREET BRUSH

- ЩЕТКА-МЕТЛА ДЛЯ УЛИЦЫ
- STSTRASSENBESEN



- Beechwood handle • Handle length 130 cm
- Handle diameter 28 mm • PVC bristle
- Beechwood frame

Code	Width [mm]	
32044	400	5



**1 STREET BRUSHES WITHOUT HANDLE**

• УЛИЧНЫЕ ЩЕТКИ • PVC-STRASSENBESEN OHNE STIEL

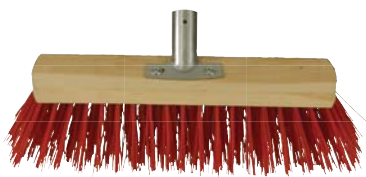

- Without handle • Plastic bristle in a wooden body • There is a metal holder for installing the stick diameter 22mm on the wooden body

Code	Size (mm)	
32053	300	10
32054	400	10
32055	500	10
32056	600	10

**2 STREET BRUSH**

• ЩЁТКА-МЕТЛА ХОЗЯЙСТВЕННАЯ • НАHAUSHALTSBÜRSTE



- Pinewood stick with thread • Green PVC bristle • Plastic frame

Code	Handle length [mm]	
32060	1200	12

**3 STREET BRUSH**

• ЩЁТКА-МЕТЛА ХОЗЯЙСТВЕННАЯ • НАHAUSHALTSBÜRSTE



- Pinewood handle with a thread • Orange PVC bristle • Plastic frame • Delivered in a box 12 pcs. for self-assembly of the handle and the head

Code	Handle length [mm]	
32061	1200	12

**4 BUILDERS SIEVES**

• СТРОИТЕЛЬНЫЕ РЕШЕТА • BAUSIEB



- Metal • For loose material separation

Code	Size (cm)	Mesh (mm)	
15901	120 x 60	20 x 20	1
15902	120 x 60	10 x 10	1
15903	120 x 60	8 x 8	1
15904	120 x 60	6 x 6	1
15905	120 x 60	4 x 4	1
15920	100 x 50	4 x 4	1

**5 GALVANISED BUCKET**

• ВЕДРО СТРОИТЕЛЬНОЕ • BAUEIMER



- Metal, galvanised • For general building purposes

Code	Volume (L)	
43214	14	1

**6 GALVANIZED BUCKETS**

• ВЕДРА ОЦИНКОВАННЫЕ • UNIVERSELLE VERZINKTE EIMER FÜR DEN BAU



- Made from high-quality galvanised steel • Sealed bottom with a wire handle • For general building purposes • Manufactured in Europe

Code	Volume [l]	
43201	5	1
43202	10	1
43203	15	1

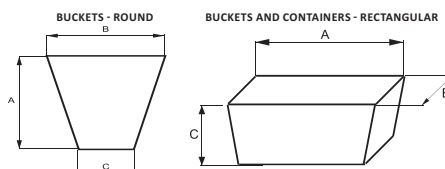

**7 BUILDERS BUCKETS**

• ВЕДРА СТРОИТЕЛЬНЫЕ • BAUEIMER



- Plastic • Wire handle

Code	Volume (l)	A x B x C (mm)	
BP29437A	12	235 x 320 x 250	1155
BP29436A	16	235 x 335 x 280	510
BP29434A	20	260 x 380 x 305	720

**8 BUILDERS BUCKETS**

• КОНТЕЙНЕРЫ СТРОИТЕЛЬНЫЕ • MÖRTELBOITICHE



- Plastic • With handling handles

Code	Volume (l)	A x B x C (mm)	
BP293999	40	311 x 507 x 380	130
BP294049	65	352 x 575 x 435	96
BP294050	90	400 x 645 x 496	76

**9 OPENWORK BASKET**

• КОРЗИНА АЖУРНАЯ • DURCHBROCHENER KORB ECO



- Plastic • Handles with colourful inserts

Code	Volume (l)	A x B x C (mm)	
35576	25	290 x 420 x 285	480

**10 OPENWORK GARDENING BASKET**

• КОРЗИНА АЖУРНАЯ САДОВАЯ • DURCHBROCHENER GARTEN-KORB BUNT



- Plastic • Handles with colourful inserts

Code	Volume (l)	A x B x C (mm)	
35578	35	330 x 475 x 320	280

**1 BUILDERS CONTAINERS**

• КОНТЕЙНЕРЫ СТРОИТЕЛЬНЫЕ • MÖRTELBOITTSCH



- Plastic • With handling handles

Code	Volume (l)	A x B x C (mm)	
35591	40	290 x 450 x 420	180
35592	60	335 x 600 x 560	180
35593	90	365 x 665 x 620	160

**2 BUILDERS CONTAINERS**

• КОНТЕЙНЕРЫ СТРОИТЕЛЬНЫЕ • MÖRTELBOITTSCH



- Plastic • With handling handles

Code	Volume (l)	A x B x C (mm)	
BP299251	45	580 x 380 x 295	180
BP294501	65	660 x 420 x 283	130
BP294500	90	790 x 480 x 300	84

**3 BUILDERS CONTAINERS**

• КОНТЕЙНЕРЫ СТРОИТЕЛЬНЫЕ • MÖRTELBOITTSCH



- Plastic • With handling handles

Code	Volume (l)	A x B x C (mm)	
35594	40	710 x 400 x 190	285
35596	60	710 x 400 x 290	270
35599	90	770 x 530 x 310	180

**4 BUCKET FOR TILE'S WORKS**

• ВЕДРО ДЛЯ ПЛИТОЧНЫХ РАБОТ • EIMER FÜR FLIESENLEGEARBEITEN



- Rectangular plastic bucket 16 L • Plastic handle • The set includes a mesh for removing excess mortar and two wheels

Code	Volume (l)	A x B x C (mm)	
01520	16	430 x 260 x 190	1

**5 TILING SET**

• НАБОР ДЛЯ ПЛИТОЧНЫХ РАБОТ • FLIESENLEGERSET



- The set includes: rectangular bucket 20 L, mesh, bucket rolls, wheels 2pcs, rubber-face float, sponge-face float

Code	Quantity (pcs.) in the set	
KU9901	6	1

**6 BUCKET FOR TILE'S WORKS**

• ВЕДРО ДЛЯ ПЛИТОЧНЫХ РАБОТ • EIMER FÜR FLIESENLEGEARBEITEN



- Rectangular bucket vol. 20 L • It is possible to install the wheels to move the bucket without carrying it • Plastic handle
- Delivered without rolls and wheels

Code	A x B x C (mm)	
01512	515 x 265 x 250	1

**WHEELS FOR BUKETS**

• КОЛЁСИКИ ДЛЯ ВЕДЕР • EIMERRÄDER



- To be installed on the bucket
- Sold in a set

Code	Number of pieces in the set	
KU1527	2	20

**ROOLS FOR BUKETS**

• РОЛИКИ ДВОЙНЫЕ ДЛЯ ВЕДЕР • EIMERROLLEN



- Double plastic rolls for removing excess water from the float with a sponge
- To be installed on the bucket

Code	Size (mm)	
01513	125 x 69	20

**BARs FOR BUKETS**

• РЕШЁТКА ДЛЯ ВЕДЕР • EIMERGITTER



- Mesh for removing excess mortar
- To be installed in the bucket

Code	Size (mm)	
01519	420 x 210	20

**7 3 PCS PAINT BRUSHES****ENGLISH SET**• ПЛОСКИЕ КИСТИ (ФЛЕЙЦЕВЫЕ)  
• ENGLISCHE PINSEL - 3-TLG. SET

- Natural bristle • Galvanised ferrules
- Wooden handles • 60% of brush bristle is the same length

Code	Size (mm)	
43014	24,36,90	45

**8 PAINT BRUSHES**

• ПЛОСКИЕ КИСТИ (ФЛЕЙЦЕВЫЕ) • ENGLISCHE PINSEL



- Natural bristle • Galvanised ferrule
- Wooden handle • 60% of brush bristle is the same length

Code	Width (mm)	Thickness (mm)	
43022	25	14	50
43023	36	14	50
43025	50	14	50
43026	63	14	50
43027	76	14	50
43029	90	14	50
43021	102	14	25

**9 PAINT BRUSHES**

• ПЛОСКИЕ КИСТИ (ФЛЕЙЦЕВЫЕ) • PROFESSIONELLE ENGLISCHE PINSEL



- Natural bristle • Galvanised ferrule
- Coated wooden handle • 60% of brush bristle is the same length

Code	Width (mm)	Thickness (mm)	
43062	1"	15	50
43063	1½"	15	50
43065	2"	15	50
43066	2½"	15	50
43067	3"	15	50
43068	3½"	15	50
43069	4"	15	50

### 1 RADIATOR PAINT BRUSHES

• РАДИАТОРНЫЕ КИСТИ • HEIZKÖRPERPINSEL



- Natural bristle • Galvanised ferrule
- Wooden handle • 60% of brush bristle is the same length

Code	Width (mm)	Thickness (mm)	
43032	25	8	50
43033	36	8	50
43035	50	8	50
43036	63	8	50

### 2 WALLPAPER BRUSHES

• ОБОЙНЫЕ КИСТИ (КЛЕЙСТЕРНЫЕ) • ТЕРЕТЕНPINSEL



- Natural bristle • Galvanised ferrule
- Wooden handle

Code	Width (mm)	Thickness (mm)	
43050	90	30	30
43051	110	30	30
43053	130	30	30
43054	140	40	30
43055	150	50	30

### 3 WALL BRUSHES

• МАКЛОВИЦЫ • FLÄCHENSTREICHER



- Natural bristle • Wooden han

Code	Width (mm)	Thickness (mm)	
43056	160	65	20
43058	180	75	20
43059	190	85	20

### 4 PAINT ROLLERS

• МАЛЯРНЫЕ ВАЛИКИ • FELLWALZE



- Polyamide yarn cover
- Recommended for emulsion, acrylic, oil and latex paints • Handle with steel wire Ø 6 mm

Code	Diameter x Width (mm)	
43144	50 x 100	20
43145	50 x 140	35
43146	50 x 190	60
43147	50 x 250	50

### 5 REFILLS FOR PAINT ROLLER

• ЗАПАСНЫЕ ВАЛИКИ • ERSATZFELLMALERWALZE



- Polyamide yarn cover
- Recommended for emulsion, acrylic, oil and latex paints • For the handle with steel wire Ø 6 mm

Code	Diameter x Width (mm)	
43141	50 x 150	45
43142	50 x 190	30
43143	50 x 250	25

### 6 PAINT ROLLERS

• МАЛЯРНЫЕ ВАЛИКИ „СИНТЕКС“ • LANGFLORIG MALERWALZE MIT SCHNURBELAG SYNTEX



- For economic coating of large areas with emulsion, latex and silicate paints • String cover • Don't use for paints and varnishes based on nitro thinners • Handle with steel wire Ø 8 mm

Code	Diameter x Width (mm)	
43154	50 x 190	60
43155	50 x 250	50

### 7 REFILLS FOR PAINT ROLLER

• ЗАПАСНЫЕ ВАЛИКИ „СИНТЕКС“ • ERSATZMALERWALZE



- For economic coating of large areas with emulsion, latex and silicate paints • String cover • Don't use for paints and varnishes based on nitro thinners • For the handle with steel wire Ø 8 mm

Code	Diameter x Width (mm)	
43156	50 x 190	30
43157	50 x 250	40

### 8 PAINT ROLLERS

• МАЛЯРНЫЕ ПОРОЛОНОВЫЕ ВАЛИКИ • SCHAUMSTOFFMALERWALZEN



- Designed for coating smooth surfaces
- Not recommended for cellulose-based paints and varnishes • Handle with steel wire Ø 6 mm

Code	Diameter x Width (mm)	
43125	35 x 50	70
43126	35 x 70	60
43127	35 x 110	40
43128	35 x 150	25
43129	50 x 150	20

### 9 REFILLS FOR PAINT ROLLERS

• ЗАПАСНЫЕ ПОРОЛОНОВЫЕ ВАЛИКИ • ERSATZSCHAUMSTOFFMALERWALZE



- Recommended for coating smooth surfaces
- Not recommended for cellulose-based paints and varnishes • For the handle with steel wire Ø 6 mm

Code	Diameter x Width (mm)	
43120	35 x 50	10/300
43121	35 x 70	10/250
43122	35 x 100	10/130
43123	35 x 150	5/90
43124	50 x 150	5/80

**1 PAINT ROLLERS**

• МАЛЯРНЫЕ ВАЛИКИ • KURZFLORIGE MALERWALZE MIT SCHNURBELAG

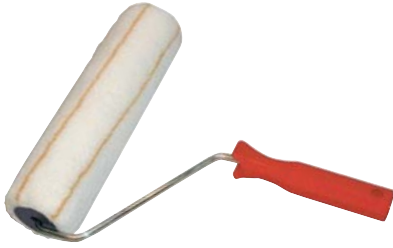

- Cover with a short and thick string pile
- Recommended for coating smooth surfaces
- Handle with steel wire Ø 8 mm

Code	Diameter x Width (mm)	📦
43162	50 x 190	60
43163	50 x 250	50

**2 REFILLS FOR PAINT ROLLERS**

• ЗАПАСНЫЕ ВАЛИКИ • ERSATZMALERWALZE FÜR KURZFLORIGEN SCHNURBELAG



- Cover with a short and thick string pile
- Recommended for coating smooth surfaces
- For the handle with steel wire Ø 8 mm

Code	Diameter x Width (mm)	📦
43160	50 x 190	30
43161	50 x 250	25

**3 PAINTERS BUCKET**

• МАЛЯРНОЕ ВЕДРО • MALEREIMER



- Rectangular plastic bucket
- Wire handle

Code	Volume (l)	A x B x C (mm)	📦
43211	12	350 x 250 x 200	20

**4 PAINT ROLLER KITS**

• МАЛЯРНЫЕ ПОРОЛОНОВЫЕ ВАЛИКИ С ВАННОЧКОЙ • SCHAUMSTOFFWALZEN MIT FARBWANNE



- Sponge rollers for coating smooth surfaces
- Not recommended for cellulose-based varnishes • Plastic handle and a tray

Code	Roller width (mm)	📦
43130	50	30
43131	70	30
43132	110	30
43133	150	30

**5 PAINT TRAYS**

• МАЛЯРНЫЕ ПЛАСТИКОВЫЕ ВАННОЧКИ • FARBWANNEN



- Plastic

Code	Width (mm)	📦
43172	100	100
43173	210	100
43174	250	50
43175	320	50

**6 PAINT ROLLER SETS**

• МАЛЯРНЫЕ ВАЛИКИ С РЕШЕТКОЙ • FELLMALERWALZEN MIT MALERGITTER



- Rollers with polyamide yarn cover
- Recommended for emulsion, acrylic, oil and latex paints

Code	Roller width (mm)	📦
43150	100	30
43151	140	30
43152	190	30
43153	250	25

**7 PAINT CRATES**

• МАЛЯРНЫЕ ПЛАСТИКОВЫЕ РЕШЕТКИ • MALERGITTER



- Plastic

Code	Width (mm)	📦
43170	215	100
43171	270	100

**8 EXTENSION BAR**

• ТЕЛЕСКОПИЧЕСКАЯ РУКОЯТКА ДЛЯ МАЛЯРНЫХ ВАЛИКОВ • TELESKOPSTANGE



- For extending painter's tools

Code	Length (mm)	📦
43176	1000-2000	20

**9 PAINTERS DUST SHEETS**

• МАЛЯРНЫЕ ПЛЕНКИ • MALERFOLIEN



- For protecting surfaces while painted

Code	Size (m)	Thickness (µm)	📦
F60000	4 x 5	0.7	40
F60003	4 x 5	20	25
F60001	4 x 5	45	10

**10 PAINT SCRAPER**

• СКРЕБОК МАЛЯРНЫЙ • MALERSCHABER SCHWARZ



- For removing old paint from the surface

Code	Width (mm)	📦
01430	120	100

**1 PAINT SCRAPER WITH REMOVAL BLADE**

- СКРЕБОК МАЛЯРНЫЙ СО СМЕННЫМИ ЛЕЗВИЯМИ
- MALERSCHABER MIT AUSWECHSELBARER KLINGE



- Blade fixed with pressure screws
- For removing old paint from the surface

Code	Width (mm)	
01435	100	30

**2 PAINT SCRAPER BLADE FOR 01435**

- СМЕННОЕ ЛЕЗВИЕ ДЛЯ СКРЕБКА
- ERSATZKLINGEN FÜR SCHABER MIT ANGESCHRAUBTER KLINGE



- Replaceable blade for scraper 01435

Code	Width (mm)	
01436	100	300

**3 PAINT SCRAPER WITH REMOVAL BLADE**

- МАЛЯРНЫЙ СКРЕБОК СО СМЕННЫМ ЛЕЗВИЕМ
- MALERSCHABER MIT AUSWECHSELBARER KLINGE



- Snap-on blade
- For removing old paint from the surface

Code	Width (mm)	
01437	100	30

**4 TILE CUTTERS BLADES FOR 01437**

- СМЕННОЕ ЛЕЗВИЕ ДЛЯ СКРЕБКА
- ERSATZKLINGEN FÜR SCHABER MIT SCHNAPPVERSCHLUSS



- Replaceable blade for scraper 01437

Code	Width (mm)	
01438	100	300

**5 PAINTING PAPER TAPES**

- МАЛЯРНЫЕ КРЕПИРОВАННЫЕ ЛЕНТЫ
- MALERBAND



- Glue based on natural rubber and artificial components • Yellow • Paper • Length 35m • Multipurpose • Max. work temperature 60°C • The tape should be removed directly after coating • The tape must not be exposed to sunlight

Code	Width (mm)	
43320	19	12/48
43326	25	9/36
43331	30	10/40
43339	38	6/24
43349	48	6/24

**6 INSULATION TAPES**

- ТЕФЛОНОВЫЕ УПЛОТНИТЕЛЬНЫЕ ЛЕНТЫ • ISOLIERBÄNDER



13119

13114  
13116  
13118

- For gas systems

Code	Width x Thickness x Length (mm x mm x m)	
13119	12 x 0.1 x 13.2	250

• For plumbing works

Code	Width x Thickness x Length (mm x mm x m)	Quantity	
13114	12 x 0.1 x 13.2	1	10/250
13116	19 x 0.2 x 16.5	1	5/50
13118	12 x 0.075 x 13.2	1	10/250

**7 INSULATION TAPES**

- ТЕФЛОНОВЫЕ УПЛОТНИТЕЛЬНЫЕ ЛЕНТЫ • ISOLIERBÄNDER



- For plumbing works

Code	Width x Thickness x Length (mm x mm x m)	Quantity	
13110	12 x 0.075 x 10	1	10/1000
13113	12 x 0.075 x 10	3	150/300

**8 SILICONE TAPES**

- ОТДЕЛОЧНЫЕ СИЛИКОНОВЫЕ ЛЕНТЫ
- FERTIGUNGSSILIKONBAND



- White

Code	Width x Length (mm x m)		
MNSI223W	22 x 3.35	x	36
MNSI383W	38 x 3.35	x	20

**9 VINYL FLOORING TAPE**

- ДВУХСТОРОННЯЯ МОНТАЖНАЯ ЛЕНТА ДЛЯ КОВРОВЫХ ПОКРЫТИЙ • TERRISCHKLEVBAND



- Two-side glue • Made from polypropylene
- Recommended for sticking flooring, carpets, boards, banners etc.

Code	Width x Length (mm x m)	
F32000	50 x 5	52

**10 ALL-PURPOSE TAPES**

- УНИВЕРСАЛЬНЫЕ КЛЕЮЩИЕ ЛЕНТЫ • КЛЕВЕБАН „DUCT TAPE“



- Reinforced with plastic mesh • Multipurpose
- Used e.g. for pipe sealing, surface repair • Grey

Code	Width x Length (mm x m)	
13131	48 x 9	72
13132	48 x 22	30

**1 ALL-PURPOSE TAPES**

• УНИВЕРСАЛЬНЫЕ КЛЕЮЩИЕ ЛЕНТЫ • UNIVERSALKLEBE BAND  
"DUST TAPE"



- Grey • Reinforced with plastic mesh
- All-purpose, e.g. for sealing pipes, repairing surfaces etc.

Code	Width x Length (mm x m)	
13136	48 x 9	24
13138	48 x 22	24

**2 PACKING TAPE**

• КЛЕЮЩАЯ ЛЕНТА – ПРОЗРАЧНАЯ (СКОТЧ) • PASKLEBEVAND  
DURCHSICHTIG



- Artificial-ingredient glue • Transparent

Code	Width x Length (mm x m)	
13133	48 x 35	6/36

**3 TRANSPARENT PACKING TAPES**

• КЛЕЮЩАЯ ЛЕНТА – ПРОЗРАЧНАЯ (СКОТЧ)  
• PASKLEBEVAND DURCHSICHTIG



- Artificial-ingredient glue

Code	Width x Length (mm x m)	Colour	
13171	48 x 35	transparent	12/36
13134	48 x 35	brown	12/36

**4 ADHESIVE TAPE**

• КЛЕЮЩАЯ ЛЕНТА (СКОТЧ) • КЛЕВЕVAND



- Polypropylene adhesive tape metallized
- Made from PP foil with acrylic glue

Code	Width x Length (mm x m)	
13151	48 x 50	36

**5 WARNING TAPE**

• СИГНАЛЬНАЯ ЛЕНТА • WARNBAND

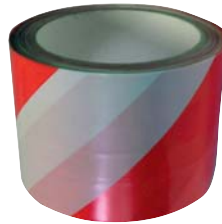

- Red and white without glue

Code	Width x Length (mm x m)	
13163	75 x 100	24

**6 YELLOW-BLACK WARNING TAPES**

• СИГНАЛЬНАЯ ЛЕНТА • WARNBAND



- Yellow and black without glue

Code	Width x Length (mm x m)	
13165	75 x 100	24
13167	120 x 100	12

**7 INSULATION TAPES**

• ИЗОЛЯЦИОННЫЕ ЛЕНТЫ • ISOLIERBÄNDER



- Certified up to 1 kV • PVC • Thickness 0.15 mm • Sold individually • Different colours

Code	Width x Length (mm x m)	
13101	15 x 10	10/100
13102	19 x 20	8/96

**8 INSULATION TAPES - PVC**

• ИЗОЛЯЦИОННЫЕ ЛЕНТЫ • ISOLIERBÄNDER



- Certified up to 1kV • PVC • Thickness 0.15mm • Sold individually

Code	Width x Length (mm x m)	Colour	
13101C	15 x 10	black	10/100
13101Z	15 x 10	green	10/100
13101L	15 x 10	yellow/green	10/100
13101R	15 x 10	red	10/100
13102C	19 x 20	black	8/96
13102Z	19 x 20	green	8/96
13102L	19 x 20	yellow/green	8/96

**9 WOOD SCRAPERS**

• ЦИКЛИ • ZIENKLINGEN



61304



61306

61401  
61402

- Wooden handle
- For finishing works
- For removing old paint from wooden surface

Code	Width (mm)	
61304	40	25
61306	60	25

- Wood scraper blades

Code	Width (mm)	
61401	40	100
61402	60	100

**10 ADJUSTABLE TILE HOLE CUTTERS**

• РЕЗАКИ ДЛЯ ПЛИТКОРЕЗА – БАЛЕРИНКА • FLIESENKNÄVVER



- With replaceable blade

Code	Size (mm)		
75010	30 - 110	x	100



- Replaceable blade for 75010

Code	Size (mm)	
75012	12,8 x 5,7	100

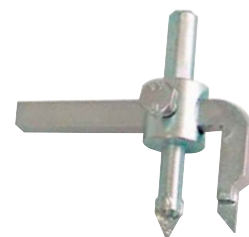

- With fixed blade

Code	Size (mm)		
75011	30 - 110	x	100
75770	20 - 90	x	100

**1 ADJUSTABLE TILE HOLE CUTTER**

• СВЕРЛО ПО КЕРАМИКЕ • KNABBER FÜR BOHRUNGEN IN FLIESEN



- Pin diameter 12 mm • Three blades on the perimeter every 120° with replaceable blades 75012 • For precision hole cutting in tiles, three blades ensure precise finish

Code	Diameters (mm)	
75013	33, 53, 67, 83	10

**2 JOINT SCRUBBERS**

• СКРЕБОК ДЛЯ КАФЕЛЯ (ОЧИСТКА ШВОВ) • FUGENSCHABER



- Replaceable blade with tungsten fill
- Plastic handle

Code	Size (mm)	
01404	30	50
01405	50	40

- Replaceable blade

Code	Size (mm)	
01410	30	10
01411	50	50

**3 JOINT SCRUBBERS**

• СКРЕБОК ДЛЯ КАФЕЛЯ (ОЧИСТКА ШВОВ) • FUGENSCHABER



- Blade with tungsten carbide coat • Plastic handle • Delivered with two blades

Code	Size (mm)		
69401	50	x	50
69402	38	x	60

**4 DEVICE FOR LEVELING TILES**

• ОТВЕС ДЛЯ УКЛАДКИ КАФЕЛЯ • VORRICHTUNG ZUM AUSRICHTEN VON FLIESEN



- Enables to determine tile laying line quickly and easily • Galvanised plates are holders of a thin rubber delineating the joint course when stretched

Code	
61380	60

**5 WOODEN HAMMER**

• ДЕРЕВЯННАЯ КИЯНКА • HOLZHAMMER



- Woodworker's hammer for slogging

Code	Weight (g)	
12011	500	30

**6 WOODEN HAMMER**

• ДЕРЕВЯННАЯ КИЯНКА • HOLZHAMMER



- Tinworker's hammer for slogging

Code	Diameter (mm)	
12012	70	40

**7 SPOKESHAVE**

• СКОБЕЛЬ • SCHABMESSER



- Wooden handles • In a plastic bag

Code	Length (mm)	Blade length (mm)	
12266	300	200	25

**8 PICKAXES**

• ДВУХЗУБЫЕ КИРКИ • KEILHAUEN



**HRC**  
43±3

- Quenched at ends • Wooden shank 90 cm long • Delivered for self-assembly • Head weight tolerance: 12335: from 1.3 to 1.5 kg, 12330 from 2.3 to 2.5 kg

Code	Weight (g)	
12335	1500	6
12330	2500	6

**9 PICKAXE**

• ОДНОЗУБЫЕ КИРКИ • BERGBAUSPITZHASKE



**HRC**  
43±3

- Quenched at ends • Wooden shank 90 cm long • Delivered for self-assembly • Head weight tolerance: from 1.3 to 1.5 kg

Code	Weight (g)	
12331	1500	6

**1 STRAIGHT SPADE**

• ШТЫКОВАЯ ПРЯМОУГОЛЬНАЯ ЛОПАТА • SPATEN GERADE GENIETET



• Wooden handle with T holder • Riveted

Code	Length (mm)	
12337	1170	5

**4 SHARP SPADES**• ШТЫКОВАЯ ТРЕУГОЛЬНАЯ МЕТАЛЛИЧЕСКАЯ ЛОПАТЫ  
• SPATEN SCHARF

• Metal handle with DY holder • Head welded to the handle • 12270 - plastic caps on handle

Code	Head size (mm)	Colour	
12270	200 x 280	graphite	5

**2 STRAIGHT SPADE**

• ШТЫКОВАЯ ПРЯМОУГОЛЬНАЯ ЛОПАТА • SPATEN GERADE



• Wooden handle with T holder • Lightweight structure without riveting

Code	Length (mm)	
12338	1170	5

**5 CORDIAL SAND SPADE**

• СОВКОВАЯ ЛОПАТА ДЛЯ ПЕСКА • SANDSCHAUFEL HERZFÖRMIG



• Wooden handle with T holder

Code	Head size (mm)	Handle length (mm)	
12275	230 x 290	1000	5

**3 STRAIGHT SPADES**

• ШТЫКОВАЯ ПРЯМОУГОЛЬНАЯ МЕТАЛЛИЧЕСКАЯ ЛОПАТЫ • SPATEN GERADE



• Metal handle with DY holder • Head welded to the handle • 12271 - plastic caps on handle

Code	Head size (mm)	Colour	
12271	200 x 280	graphite	5

**6 SAND SHOVEL**

• СОВКОВАЯ ЛОПАТА • SANDSCHAUFEL



• Wooden handle with T holder

Code	Width (mm)	Length (mm)	
12332	240	1170	5



**1 SAND SHOVELS**

• СОВКОВАЯ ЛОПАТЫ • SANDSCHAUFEL



- Metal handle with DY holder
- Head welded to the handle
- 12273 - plastic caps on handle

Code	Head size (mm)	Colour	
12273	230 x 280	graphite	5

**2 COAL SHOVEL**

• ЛОПАТА ДЛЯ УГЛЯ • KOHLESCHAUFEL



- Wooden handle with T holder

Code	Head size (mm)	Length (mm)	
12333	240 x 315	1250	5

**3 COAL SHOVEL**

• ЛОПАТА ДЛЯ УГЛЯ • KOHLESCHAUFEL



- Wooden handle with T holder

Code	Head size (mm)	Length (mm)	
12334	285 x 355	1160	5

**4 PLASTIC SNOW SHOVEL**

• ЛОПАТА ДЛЯ СНЕГА • SCHNEESCHAUFEL AUS KUNSTSTOFF



- For removing snow or loose materials
- Black plastic head with a steel section
- 90 cm wooden handle with a plastic DY holder
- Delivered for self-assembly without fixing screws

Code	Head size (mm)	
12354	455 x 360	10

**5 PLASTIC SNOW SHOVEL**

• ЛОПАТА ДЛЯ СНЕГА • SCHNEESCHAUFEL AUS KUNSTSTOFF



- For removing snow or loose materials
- Black plastic head with a steel section
- 90 cm wooden handle with a plastic DY holder
- Delivered for self-assembly with the fixing screws

Code	Head size (mm)	
12342	485 x 395	10

**6 PLASTIC SNOW SHOVEL**

• ЛОПАТА ДЛЯ СНЕГА • SCHNEESCHAUFEL AUS KUNSTSTOFF



- For removing snow or loose materials
- Colourful plastic head with a steel section
- 90 cm wooden handle with a plastic DY holder
- Delivered for self-assembly with the fixing screws

Code	Head size (mm)	
12367	440 X 335	10

**7 PLASTIC SNOW SHOVEL**

• ЛОПАТА ДЛЯ СНЕГА • SCHNEESCHAUFEL AUS KUNSTSTOFF



- For removing snow or loose materials
- Heavy-duty, coloured plastic head with an aluminium section
- 90 cm wooden handle, dia. 38mm, with a plastic DY holder
- Delivered for self-assembly with the fixing screws

Code	Head size (mm)	
12363	445 x 410	10

**1 METAL SNOW SHOVEL**

• ЛОПАТА ДЛЯ СНЕГА МЕТАЛЛИЧЕСКАЯ • METALLSCHNEESCHAUFEL



- For removing snow or loose materials • Steel sheet head 1.2 mm thick
- Profiled head, fixed with 3 aluminium rivets to the metal handle dia. 32 mm, bent • Handle with a plastic DY holder

Code	Head size (mm)	
12347	480 x 310	5

**2 METAL SNOW SHOVEL**

• ЛОПАТА ДЛЯ СНЕГА МЕТАЛЛИЧЕСКАЯ • SCHNEESCHAUFEL



- For removing snow or loose materials • Delivered for self-assembly without fixing screws • Steel sheet head 1.2 mm thick • Profiled head on a wooden handle dia. 32 mm and 100 cm long • Handle with a wooden T holder

Code	Head size (mm)	
12348	480 x 310	5

**3 ALUMINIUM SNOW SHOVEL**

• ЛОПАТА ДЛЯ СНЕГА АЛЮМИНИЕВАЯ • ALUMINIUMSCHNEESCHAUFEL

**AL**

- For removing snow or loose materials • Delivered for self-assembly without fixing screws • Aluminium sheet head 2mm thick • Profiled head on a wooden handle dia. 32 mm and 100 cm long • Handle with a wooden T holder

Code	Head size (mm)	
12349	480 x 310	5

**4 SNOW SLEIGHT SHOVEL**

• ЛОПАТА-ПЛУГ • SCHNEEABSTREIFER



- For pushing aside snow or loose materials • Black plastic head with an aluminium section, two additional rolls for easier rake guiding on the surface • Metal handle • Delivered for self-assembly with the fixing components

Code	Head size (mm)	
12192	785 x 450	5

**5 SNOW SLEIGHT SHOVEL**

• ЛОПАТА-ПЛУГ • SCHNEEABSTREIFER



- Heavy-duty plastic head on 2 wheels with an aluminium profile • Metal holder • Delivered for self-assembly with fixing components

Code	Size (mm)	
12364	785 x 450	5

**1 ICE HAMMER**

• ЛЕДОРУБ УЛИЧНЫЙ • EISSTÖSSER



• Wooden handle • For ice removal

Code	Length [mm]	Width [mm]	
12370	1180	200	5

**2 BRUSH WITH SCRAPER**

• ЩЕТКА СО СКРЕБКОМ • BÜRSTE MIT SCHABER



• Polypropylene handles • Scraper made from ABS fixed with a non-detachable snap fastener • PET bristle • Delivered in five (mixed) colours (red, green, blue, yellow, black), in boxes 10 pcs. of each colour

Code	Length [mm]	Width of sweeping [mm]	Width of scraper [mm]	
32058	425	120	88	60

**3 WOODEN HANDLE FOR MASONRY HAMMER**

• ДЕРЕВЯННЫЙ ЧЕРЕНОК ДЛЯ МОЛОТКА КАМЕНЩИКА • MAURERHAMMERSTIEL



• Beech wood

Code	Length [cm]	For hammer weight [g]	
12902	32	500 - 800	20

**4 WOODEN HANDLES FOR MACHINIST HAMMERS**

• ДЕРЕВЯННЫЕ ЧЕРЕНКИ ДЛЯ МОЛОТКА • HOLZHAMMERSTIELE



• Beech wood

A - profile height for the installation [mm]

A - profile width for the installation [mm]

12900 (A-28, B-18), 12901 (A-30, B-20)

12903 (A-32, B-22), 12904 (A-34, B-24)

12905 (A-36, B-26), 12906 (A-40, B-28)

12907 (A-42, B-30), 12908 (A-46, B-32)

12909 (A-48, B-34), 12932 (A-50, B-36)

Code	Length [cm]	For hammer weight [g]	
12900	28	100	50
12901	32	200	50
12903	36	300 - 400	50
12904	40	500 - 800	50
12905	42.5	800 - 1000	50
12906	50	1000 - 1500	25
12907	60	2000 - 3000	10
12908	70	4000 - 5000	10
12909	80	6000 - 8000	10
12932	90	8000 - 10000	10

**5 WOODEN HANDLES FOR AXES**

• ДЕРЕВЯННЫЕ ЧЕРЕНКИ ДЛЯ ТОПОРОВ • AXSTIELE



• Beech wood • Profiled

Code	Length [cm]	For hammer weight [g]	
12970	32	400	25
12910	36	600	25
12911	50	800	25
12912	60	1000	25
12913	70	1250	25
12914	80	1500-1800	25
12915	90	1800-2500	25

**6 WOODEN HANDLES FOR PICKS**

• ДЕРЕВЯННЫЕ ПРОФИЛИРОВАННЫЕ ЧЕРЕНКИ ДЛЯ КАЙЛ • SPITZHACKESTIELE



• Beech wood • Profiled

Code	Length [cm]	For hammer weight [g]	
12918	90	1500	10
12919	90	2500	10

### 1 WOODEN HANDLES FOR SHOVELS

- ДЕРЕВЯННЫЕ ЧЕРЕНКИ ДЛЯ ЛОПАТ
- SCHAUFELSTIELE



- Beech wood • Wooden DY holder

Code	Length (cm)	
12931	100	10



- Beech wood • T-Type holder

Code	Length (cm)	
12930	100	10



- Beech wood • No holder; diameter Ø 38 mm

Code	Length (cm)	
12925	90	10
12927	115	10
12929	150	10

### 2 WOODEN HANDLES FOR RAKES

- ДЕРЕВЯННЫЕ ЧЕРЕНКИ ДЛЯ ГРАБЛЕЙ • HARKESTIELE



- Beech wood • Diameter Ø 28 mm

Code	Length (cm)	
12945	100	25
12922	110	25
12923	130	25
12924	150	25

### 3 WOODEN HANDLES FOR STREET BRUSHES

- ДЕРЕВЯННЫЕ ЧЕРЕНКИ ДЛЯ УЛИЧНЫХ ЩЕТОК
- STRASSENBESENSTIELE



- Beech wood • Diameter Ø 22 mm
- For street brushes

Code	Length (cm)	
12941	120	25
12942	150	25
12943	180	25

### 4 THREADED BROOM HANDLE

- РУЧКА К ЩЕТКЕ ВВИНЧИВАЕМАЯ • BESENSTIEL MIT GEWINDE



- Beech wood
- With a hook and a plastic thread

Code	Length (cm)	
12933	110	25

### 5 WOODEN HANDLE FOR AXE-HAMMERS

- ДЕРЕВЯННЫЙ ЧЕРЕНОК ДЛЯ ТОПОРОВ-КОЛУНОВ
- HOLZHAMMERAXTSTIELE



- Beech wood • Profiled

Code	Length (cm)	For hammer weight (g)	
12916	90	2500, 4000	10

### 6 WOODEN HANDLE FOR SCYTHE

- ДЕРЕВЯННЫЕ ЧЕРЕНКИ ДЛЯ КОС • SENSENSTIELE



- Poplar wood, diameter 38 mm (at holders square cross section)
- For scythes, without any ferrules

Code	Length (cm)	
12971	170	10

### 7 RING WEDGES

- КОЛЬЦЕВЫЕ МЕТАЛЛИЧЕСКИЕ КЛИНЬЯ • RINGKEILE



- Metal • Delivered in plastic bags with cardboard hangers

Code	Diameters [mm]	
12920	7, 8, 10	100
12921	12, 13, 15	100

### 8 RING WEDGES

- КОЛЬЦЕВЫЕ МЕТАЛЛИЧЕСКИЕ КЛИНЬЯ • RINGKEILE



- Metal • Delivered in plastic bags with cardboard hangers

Code	Diameters [mm]		
12944	7,8,10	x	100
12946	12,13,15	x	100

### 9 RING WEDGES AND WOOD WEDGES

- КОМПЛЕКТ КЛИНЬЕВ • RINGKEILE



- The set includes: metal ring and wooden wedge • Delivered in a plastic bag with a hanger

Code	Ring diameter Ø (mm) / Wooden wedge width (mm)		
12947	7 / 20	x	100
12948	8 / 25	x	100
12950	10 / 30	x	100
12952	12 / 35	x	100
12953	13 / 40	x	100
12955	15 / 45	x	100
12958	18 / 50	x	100

### 10 ENGINEERING FILES

- НАПИЛЬНИКИ • FEILEN



- Hardness 61 ± 2 HRC
- Beech wood handle

**HRC**  
61±2

#### • Hand files

Code	Size [mm]	Dimension of the cross section [mm]	Incision	
69108	150	15.3 x 3.6	Nr 1	10 / 120
69103	150	15.3 x 3.6	Nr 2	10 / 120
69118	150	15.3 x 3.6	Nr 3	10 / 120
69101	200	19.5 x 4.8	Nr 1	5 / 75
69107	200	19.5 x 4.8	Nr 2	5 / 75
69105	200	19.5 x 4.8	Nr 3	5 / 75
69102	250	24.5 x 6.3	Nr 1	5 / 60
69104	250	24.5 x 6.3	Nr 2	5 / 60
69106	250	24.5 x 6.3	Nr 3	5 / 60

#### Half round files

Code	Size [mm]	Dimension of the cross section [mm]	Incision	
69211	150	15.8 x 4.5	Nr 1	10 / 120
69203	150	15.8 x 4.5	Nr 2	10 / 120
69213	150	15.8 x 4.5	Nr 3	10 / 120
69201	200	20.7 x 5.7	Nr 1	5 / 75
69207	200	20.7 x 5.7	Nr 2	5 / 75
69205	200	20.7 x 5.7	Nr 3	5 / 75
69202	250	24.5 x 6.8	Nr 1	5 / 60
69204	250	24.5 x 6.8	Nr 2	5 / 60
69206	250	24.5 x 6.8	Nr 3	5 / 60

#### Round files

Code	Size [mm]	Dimension of the cross section [mm]	Incision	
69249	150	6.3	Nr 1	10 / 120
69250	150	6.3	Nr 2	10 / 120
69254	150	6.3	Nr 3	10 / 120
69252	200	8.0	Nr 1	5 / 75
69251	200	8.0	Nr 2	5 / 75
69253	200	8.0	Nr 3	5 / 75
69255	250	10.0	Nr 1	5 / 60
69256	250	10.0	Nr 2	5 / 60
69257	250	10.0	Nr 3	5 / 60

#### Square files

Code	Size [mm]	Dimension of the cross section [mm]	Incision	
69300	150	6.1	Nr 1	10 / 120
69301	150	6.1	Nr 2	10 / 120
69304	150	6.1	Nr 3	10 / 120
69305	200	7.6	Nr 1	5 / 75
69303	200	7.6	Nr 2	5 / 75
69306	200	7.6	Nr 3	5 / 75
69307	250	9.5	Nr 1	5 / 60
69302	250	9.5	Nr 2	5 / 60
69308	250	9.5	Nr 3	5 / 60

#### 3-square

Code	Size [mm]	Dimension of the cross section [mm]	Incision	
69341	150	10	Nr 1	10 / 120
69342	150	10	Nr 2	10 / 120
69343	150	10	Nr 3	10 / 120
69348	200	14	Nr 1	5 / 75
69351	200	14	Nr 2	5 / 75
69349	200	14	Nr 3	5 / 75
69356	250	17	Nr 1	5 / 60
69350	250	17	Nr 2	5 / 60
69357	250	17	Nr 3	5 / 60

### 1 5 PCS ENGINEERING FILE SET

- НАБОР НАПИЛЬНИКОВ – 5 ШТ.
- FEILEN - SET 5 TLG.



**HRC**  
61±2

- Wooden handles • Plastic case • Set of 5 pcs.: flat, semi-rounded, round, square, triangular

Code	Size (mm)	Incision	
69813	150	Nr 1	25
69810	150	Nr 2	25
69811	200	Nr 1	15
69812	200	Nr 2	15

### 2 ROUND CHAIN SAW FILE

- КРУГЛЫЙ НАПИЛЬНИК ДЛЯ ЗАТОЧКИ ЦЕПНЫХ ПИЛ
- SÄGENFEILEN - RUND



**HRC**  
61±2

- Wooden handle

Code	Size (mm)	Diameter (mm)	
69501	150	4	80

### 3 TRIANGULAR MILL SAW FILES

- ТРЕХУГЛЬНЫЕ НАПИЛЬНИКИ ДЛЯ ЗАТОЧКИ ЦЕПНЫХ ПИЛ
- SÄGENFEILEN - DREIECKIG



**HRC**  
61±2

- Wooden handles
- File profile in the shape of the equilateral triangle

Code	Size (mm)	Width (mm)	Type	
69515	150	13	A	10/120
69511	150	10	B	10/120
69513	150	71	C	10/120
69512	175	10	B	5/75
69514	175	8	C	5/75

### 4 FILE HANDLES

- ДЕРЕВЯННЫЕ РУКОЯТКИ ДЛЯ НАПИЛЬНИКОВ • FEILENGRIFFE



- Wooden with a metal ferrule
- old without holes for mounting file

Code	Size (mm)	
12935	75	1000
12936	95	500
12937	115	300
12938	135	200
12939	155	150

### 5 6 PCS WARDING FILES SET

- НАБОР НАПИЛЬНИКОВ – 6 ШТ. • SCHLÜSSELFEILEN - SET 6 TLG.



- Wooden handles • Plastic case
- The set includes: flat, flat-convergent, semi-rounded, round, triangular, square

Code	Size (mm)	
69691	100	25

### 6 RASPS

- РАШПИЛИ • HOLZRASPELN



- Wooden handle • Incisions no. 2

Code	Size (mm)	Dimension of the cross section (mm)	Type	
69901	200	19.5 x 4.8	flat	5/75
69941	200	20.7 x 5.5	semi-rounded	5/75
69921	200	8	round	5/75

### 7 3 PCS RASP SETS

- НАБОР РАШПИЛЕЙ – 3 ШТ. • HOLZRASPELN - SET 3 TLG.



- Wooden handles • Plastic case
- The set includes: flat, semi-rounded, round

Code	Size (mm)	Incision	
69970	200	Nr 1	25
69971	200	Nr 2	25

### 8 6 PCS NEEDLE FILE SET

- НАБОР НАДФИЛЕЙ – 6 ШТ. • FEINFEILE - SET 6 TLG.



- Length 180 mm • Incision Nr 1 • Plastic case • The set includes: flat, flat-convergent, semi-rounded, triangular, square, round

Code	Quantity (pcs.) in the set	
69601	6	25

### 9 CARBIDE GRIT FILES

- НАПИЛЬНИКИ С ВОЛЬФРАМОВЫМ НАПЫЛЕНИЕМ
- WOLFRAMFEILE



- Plastic handle • Recommended for most materials, incl. metal, plastic, laminate, ceramics, glass, wood, gypsum, quenched steel etc.

Code	Type	Size (mm)	
69411	flat large	200	1
69413	flat small	150	1
69412	semi-rounded	150	1
69414	round	150	1
69415	square	150	1

### 10 WIRE STEEL BRUSH

- ПРОВОЛОЧНАЯ ЩЕТКА • DRAHTSTAHLBÜRSTE



- Wooden handle • Brass wire bristle

Code	Length (mm)	Number of rows	
32033	258	3-row	60
32034	258	4-row	60
32035	268	5-row	60
32036	268	6-row	60

### 11 TRIPLE LEG PULLERS

- ТРЕХЗАЖИМНЫЕ СЪЕМНИКИ ПОДШИПНИКОВ
- LAGERABZIEHER DREIACHSIG



Code	Max. opening x arm length (mm)	
29730	100 x 70	26
29731	150 x 110	10
29732	200 x 130	5
29733	250 x 160	5
29734	300 x 180	4
29735	350 x 180	3

**1 TWIN LEG PULLERS**

- ДВУХЗАЖИМНЫЕ СЪЕМНИКИ ПОДШИПНИКОВ
- LAGERABZIEHER ZWEIACHSIG



Code	Max. size (width x height mm)	
29736	50 x 40	100



Code	Max. size (width x height mm)	
29737	100 x 90	25
29738	150 x 120	16
29739	200 x 150	10
29740	250 x 170	8
29741	300 x 190	6
29742	350 x 210	1
29743	400 x 230	1



Code	Max. size (width x height mm)	
29744	500 x 230	1
29745	600 x 230	1
29746	800 x 230	1
29747	1000 x 230	1

**2 JAB SAW**

- ДЕРЖАТЕЛЬ НОЖОВОЧНОГО ПОЛОТНА
- BÜGEL MIT SÄGEBLATT



- Plastic handle
- Blade 300 x 25 mm

Code	Length (mm)	
23212	300	200

**3 JAB SAW**

- ДЕРЖАТЕЛЬ НОЖОВОЧНОГО ПОЛОТНА • SÄGEBLATTBÜGEL



- Plastic handle
- For blade 300 x 25 mm

Code	Length (mm)	
23210	225	200

**4 MITRE BOXES**

- ПЛАСТИКОВЫЕ СТУСЛА • GEHRUNGSLADEN



- Made from high quality plastic
- Enable to cut at the angles 30°, 45°, 60° and 90°
- 23306 with additional eccentrics

Code	Length (mm)	Max. width of cut strips (mm)	
23301	210	40	80
23302	235	50	50
23303	290	80	30
23305	325	120	18
23306	325	120	18

**5 MITRE BOX**

- ПЛАСТИКОВОЕ СТУСЛО • GEHRUNGSLADE



- Plastic
- Enable to cut at the angles 45° and 90°

Code	Length (mm)	Max. width of cut strips (mm)	
01645	300	65	30

**6 MITRE WOOD BOX**

- ДЕРЕВЯННОЕ СТУСЛО • GEHRUNGSLADE HÖLZERN

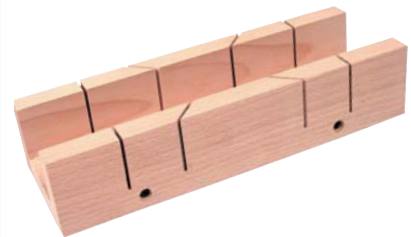

- Wooden
- Enables to cut at the angles 45° and 90°

Code	Length (mm)	Max. width of cut strips (mm)	
23313	300	65	25

**7 UNIVERSAL TITANIUM CARBIDE DRILLS**

- СВЕРЛА ПО МЕТАЛЛУ С ТИТАНОВЫМ НАПЫЛЕНИЕМ
- UNIVERSALBOHRER - AUS TITAN



- The core made from CrV steel
- The plate from special steel type: cobalt and titanium tungsten, thanks to which the drill gets a maximum hardness, resistance to abrasion and temperature
- Drill for making holes in different materials, e.g. glass, porcelain, ceramics, concrete, marble, cast iron, wood, plastic, glass fibre, granite, laminate, quenched steel

Code	Diameter x Length (mm)	
16735	3.5 x 75	100
16704	4.0 x 80	100
16705	5.0 x 90	100
16706	6.0 x 100	100
16707	7.0 x 110	100
16708	8.0 x 120	50
16709	9.0 x 130	50
16710	10.0 x 120	50
16740	10.0 x 140	50
16711	11.0 x 160	50
16712	12.0 x 160	50
16713	13.0 x 200	50
16714	14.0 x 200	10
16716	16.0 x 200	10
16718	18.0 x 200	10
16720	20.0 x 200	10

### 1 WOOD HOLE CUTTER

• РАЗДВИЖНЫЕ СВЕРЛА ПО ДЕРЕВУ • KNABBER FÜR HOLZ



- Replaceable blade
- All-purpose, with adjustable diameters

Code	Range		
64010	30 - 150	x	50
64011	spare blade		100

### 4 WOLFRAM HOLE SAWS

• КОРОНЧАТЫЕ ПИЛЫ С ВОЛЬФРАМОВЫМ НАСЫПОМ  
• LOCHSÄGEN MIT WOLFRAMAUFSCÜTTUNG



- Delivered individually on a profiled card

Code	Diameter (mm)		
26413	33	x	1
26414	43	x	1
26415	53	x	1
26416	67	x	1
26417	73	x	1
26418	83	x	1

### 2 DRILL WITH COUNTERSINK

• СВЕРЛО ПО ДЕРЕВУ С ЗЕНКОВКОЙ • BOHRER FÜR MÖBELSCHRAUBEN



- Pilot drill dia. 5 mm
- The set includes an Allen wrench for fixing

Code	Countersink diameter (mm)		
26172	7	x	100

### 5 HOLE SAW MANDREL

• ЦЕНТРОВОЧНОЕ СВЕРЛО ДЛЯ КОРОНЧАТЫХ ПИЛ  
• ZENTRIERBOHRER FÜR LOCHSÄGEN



- Pilot drill with carbide - 10 mm with hex chuck
- Delivered individually on a card

Code	Length (mm)		
26411	140	x	1

### 3 WOLFRAM HOLE SAW SET

• НАБОР КОРОНЧАТЫХ ПИЛ С ВОЛЬФРАМОВЫМ НАСЫПОМ  
• LOCHSÄGEN MIT WOLFRAMAUFSCÜTTUNG



- The set includes: hole saws Ø 33, 53, 67, 73 mm; pilot drill with carbide and disc chuck
- Delivered in cardboard box

Code	Quantity (szt.)	Range (mm)		
26426	6	33 - 73	x	30

### 6 HOLE SAW LOCATING PLATE

• ДИСКОВЫЙ ДЕРЖАТЕЛЬ • AUFNAHMETELLER FÜR LOCHSÄGEN



- Delivered individually on a card
- For hole saws Ø 33, 43, 53, 67, 73, 83 mm

Code	Range (mm)		
26410	33 - 83	x	1

### 7 DRILL CLAMP

• НАСТОЛЬНЫЙ ДЕРЖАТЕЛЬ ДРЕЛИ • TISCHGRIFF FÜR BOHRMASCHINEN



- Made from plastic
- Multilevel, rotary
- Fixing diameter Ø 43 mm with presser

Code	Type	
27046	for drilling machine	20

### 8 ARBOR

• АДАПТЕР - ПЕРЕХОДНИК ДЕРЖАТЕЛЬ ДИСКОВ ДЛЯ ДРЕЛИ  
• BOHRMASCHINENSCHAFT



- Adapter for the drilling machine, for discs or for installing grinding wheels with 22 mm opening
- Delivered in bulk

Code	Arbor diameter (mm)	
27030	6	50

### 9 ACCESSORIES FOR GRINDER

• ПРИНАДЛЕЖНОСТИ ДЛЯ УГЛОШЛИФОВАЛЬНОЙ МАШИНЫ  
• MONTAGEZUBEHÖR FÜR WINKELSCHLEIFER

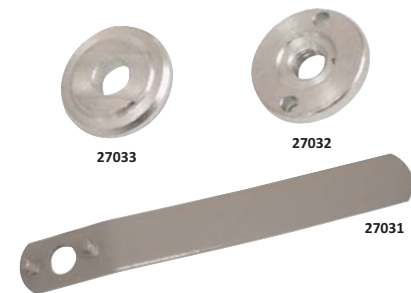

- Wrench for the angle grinder; pin distance 35 mm
- Fixing nut for the angle grinder; hole distance 35 mm
- Angle grinder pad
- Delivered in bulk

Code	Diameter (mm)	Type	
27031	14.5	Wrench	50
27032	M14	Nut	100
27033	14.2	Pad	100

# 1 JIG SAW BLADES

• ПИЛОЧКИ ДЛЯ ЭЛЕКТРОЛОБЗИКОВ • SCHWEIFSAĞEBLATT

## chuck A



**AEG - Bosch - Elu - Festo - Flex - Hitachi HolzHer - Lenox - Mafell - Makita - Metabo Milwaukee - Sparky - Tryton - Vulcan**

## chuck B



**Black & Decker Ryobi - Skil - Stayer - Kress - Wolf**

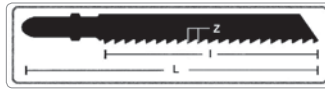

**CrV**

- Cr-V steel • In the set of 5 on a card • Collective packagings: cardboard box: 20 boxes x 5 pcs. (100 pcs.)



- For finish cutting of hard- and softwood, plywood, laminated fibreboard, plastic
- Thickness of material to be cut 4-30 mm

Code	Chuck	Z	I x L (mm)	Box
83101	A	10TPI - 2.5MM	75x100	20
83401	B	10TPI - 2.5MM	75x100	20

- For straight-line cutting of materials 6-100 mm thick

Code	Chuck	Z	I x L (mm)	Box
83101L	A	10TPI - 2.5MM	110x132	20
83401L	B	10TPI - 2.5MM	110x132	20



- For non-chip finishing cutting, for cutting laminated fibreboard, hard- and softwood, plywood, plastic
- Thickness of material to be cut 4-30 mm

Code	Chuck	Z	I x L (mm)	Box
83102	A	10TPI - 2.5MM	75x100	20
83402	B	10TPI - 2.5MM	75x100	20



- For quick, rough cutting of hard- and softwood, plywood and plastic
- Thickness of material to be cut - wood and plastic 6-60 mm, panels 8-60 mm

Code	Chuck	Z	I x L (mm)	Box
83103	A	6TPI - 4.0MM	75x100	20
83403	B	6TPI - 4.0MM	75x100	20

- For cutting materials 6-100 mm thick

Code	Chuck	Z	I x L (mm)	Box
83103L	A	6TPI - 4.0MM	110x132	20
83403L	B	6TPI - 4.0MM	110x132	20



- For very quick, straight-line finishing cutting in hard- and softwood and plywood
- Thickness of material to be cut 8-60 mm

Code	Chuck	Z	I x L (mm)	Box
83104	A	6TPI - 4.0MM	75x100	20
83404	B	6TPI - 4.0MM	75x100	20



- For very quick, curved-line finishing cutting in hard- and softwood and plywood
- Thickness of material to be cut 8-60 mm

Code	Chuck	Z	I x L (mm)	Box
83105	A	6TPI - 4.0MM	75x100	20
83405	B	6TPI - 4.0MM	75x100	20



- For quick rough cutting of hard- and softwood, and plastic

Code	Chuck	Z	I x L (mm)	Box
83106	A	8TPI - 3.0MM	75x100	20
83406	B	8TPI - 3.0MM	75x100	20

- For cutting materials 6-100 mm thick

Code	Chuck	Z	I x L (mm)	Box
83106L	A	10TPI - 2.5MM	40x132	20



- For quick, rough, straight-line cutting of handand softwood, plywood and plastic
- Thickness of material to be cut 2-15 mm

Code	Chuck	Z	I x L (mm)	Box
83108	A	12TPI - 2.0MM	50 x 75	20
83408	B	12TPI - 2.0MM	50 x 75	20



- For straight-line cutting of thin materials, e.g. soft steel, aluminium, non-ferrous metals, stainless steel • Thickness of material to be cut 1.5-3 mm

Code	Chuck	Z	I x L (mm)	Box
83111	A	21TPI - 1.2MM	50 x 75	20
83411	B	21TPI - 1.2MM	50 x 75	20
83110	A	28TPI - 0.9MM	50 x 75	20



- Bimetallic • For straight-line cutting of mild steel, aluminium, nonferrous metals, stainless steel, plexiglass
- Thickness of material to be cut 1.5-3 mm

Code	Chuck	Z	I x L (mm)	Box
83111F	A	21TPI - 1.2MM	50 x 75	20



- For cutting thicker of metals, non-ferrous metals and aluminium
- Thickness of material to be cut 3-6 mm

Code	Chuck	Z	I x L (mm)	Box
83113	A	12TPI - 2.0MM	50 x 75	20

- Bimetallic • For straight-line cutting of wood with nails, non-ferrous metals, aluminium, soft steel, other steel and plastic
- Thickness of materials: wood 3-30 mm, metal, aluminium and plastic 3-12 mm

Code	Chuck	Z	I x L (mm)	Box
831135F	A	12TPI - 2.0MM	75 x 100	20



- Perfect for straight cutting of plexi, non-ferrous metals and aluminium
- Thickness of materials to be cut: aluminium 2-20 mm, plexi and non-ferrous metals 2-10 mm

Code	Chuck	Z	I x L (mm)	Box
83116	A	12TPI - 2.0 mm	75x100	20



- Bimetallic • Perfect for quick straightline cutting of aluminium and metal, non-ferrous metals, glass fibre and plastic
- Cutting materials 4-20 mm thick

Code	Chuck	Z	I x L (mm)	Box
83118F	A	8TPI - 3.0MM	75x100	20



- For cutting abrasive materials, straight-line cutting of ceramics, glass, glass fibre
- Cutting materials 1-15 mm thick
- Delivered individually

Code	Chuck	Z	I x L (mm)	Box
83122	A	grit	75x100	5



- For non-chip finishing cutting of laminated fibreboard, hard- and softwood, plastic
- Thickness of material to be cut 3-60 mm

Code	Chuck	Z	I x L (mm)	Box
83160	A	12TPI - 2.0MM	75x100	20

- For cutting materials 3-100 mm thick

Code	Chuck	Z	I x L (mm)	Box
83165	A	12TPI - 2.0MM	110x132	20



- Bimetallic • For straight-line cutting of plastic, laminated panels, plywood, plexi, glass fibre
- Thickness of material to be cut: 3-40 mm, plywood 3-10 mm

Code	Chuck	Z	I x L (mm)	Box
83160F	A	12TPI - 2.0MM	75x100	20



- HSS - For straight-line cutting of ferrous and non-ferrous metals
- Thickness of material to be cut: 4-10 mm

Code	Chuck	Z	I x L (mm)	Box
83118	A	8TPI - 3.0MM	75x100	20



- HSS - For straight-line cutting of ferrous and non-ferrous metals, and plastic
- Thickness of material to be cut: 1-8 m

Code	Chuck	Z	I x L (mm)	Box
83115	A	12TPI - 2.0MM	110x132	20



### 1 SELF ADHESIVE PAPER DISCS

- КРУЖКИ ШЛИФОВАЛЬНЫЕ НА САМОЗАЦЕПЛЯЕМОЙ ОСНОВЕ
- SCHLEIFSCHLEIBEN AUS PAPIER, HAFTEND



- Application: for grinding metals and wood
- Sold individually

Code	Diameter (mm)	Granulation	
45780	125	16	50
45781	125	24	50

### 2 ABRASIVE BLOCKS

- РУЧНЫЕ ШЛИФОВАЛЬНЫЕ БРУСКИ • SCHLEIFKLOTZ

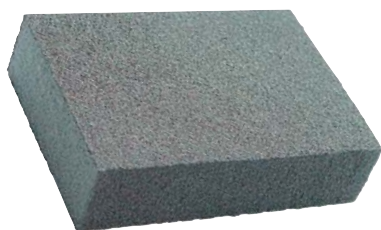

- SK 500 • Dimensions 98 x 68 x 25 mm
- Grit on four sides • Application: for finishing different coats, e.g. paint, varnish, filler, for machining wood or plastic

Code	Granulation	
49193	60	100
49194	80	100
49195	100	100
49196	120	100

### 3 ABRASIVE SPONGES

- ШЛИФОВАЛЬНЫЕ ПОЛИРОВОЧНЫЕ ГУБКИ • POLIERSCHWAMM

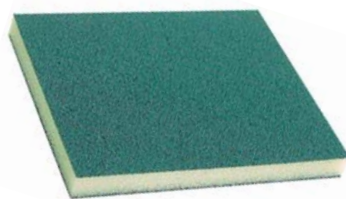

- SW 501 • Dimensions 120 x 98 x 10 mm
- Grit on two sides • Application: for finishing various surfaces, e.g. wood, paint, varnish, filler, possibly plastic

Code	Granulation	
45768A	120	100
45769A	220	100

### 4 SANDING PAD SET

- ОПОРНАЯ ТАРЕЛКА ДЛЯ ШЛИФОВАНИЯ • POLIERMITTELTRÄGER AUS GUMMI MULTIDYSK 125 MM MIT DISTANZHALTER AUS SCHAUMSTOFF



- Pin dia. 6 mm • Application: as an adapter for a drill on selfadhesive abrasive discs Ø 125 mm

Code	Diameter (mm)	Max. number of turns [1/min.]		
27039	125	3500	x	50

### 5 SANDING PAD SET

- ОПОРНАЯ ТАРЕЛКА ДЛЯ ШЛИФОВАНИЯ С КОНТРОЛГАЙКОЙ • POLIERMITTELTRÄGER AUS GUMMI MIT GEGENVERSCHLUSS MULTIDYSK 125 MM MIT KLETTE



- Pin dia. 6 mm • With a counter, enabling to adjust the disc tilting • Application: as an adapter for a drill on selfadhesive abrasive discs Ø 125 mm

Code	Diameter (mm)	Max. number of turns [1/min.]		
27041	125	3500	x	50

### 6 POLISHING FELT DISCS

- ПОЛИРОВАЛЬНЫЕ НАСАДКИ • POLITURZUBEHÖR



27045, 27050



27044

- Polishing fur with a puller



27042, 27053



27043, 27056

- Self-adhesive polishing felt

Code	Type	Diameter (mm)	
27042	felt	125	200
27043	velcro	125	200
27044	sponge	125	100
27045	fur	125	100
27050	fur	180	10
27053	felt	180	10
27056	velcro	180	20

### 7 SANDING PAD SET

- ОПОРНАЯ ТАРЕЛКА ДЛЯ ШЛИФОВАНИЯ • POLIERMITTELTRÄGER AUS GUMMI MULTIDYSK 125 MM MIT KLETTE



- Pin dia. 6 mm • Application: as an adapter for a drill on selfadhesive abrasive discs Ø 125 mm

Code	Diameter (mm)	Max. number of turns [1/min.]		
27040	125	3500	x	50

### 8 POLISHING FELT DISC

- ПОЛИРОВАЛЬНАЯ ВОЙЛОЧНАЯ НАСАДКА СО ШНУРКОМ • POLIERFELL MIT BAND



- For vehicle polishing machine

Code	Diameter (mm)	
27048	240	10



### 1 KROPELKA INSTANT GLUE

• КЛЕЙ МОМЕНТАЛЬНЫЙ КРОПЕЛКА • KROPELKA INSTANT KLEBER



- Used for instant gluing of: metal, leather, porcelain, wood, rubber, faience, ceramics, plastic (does not bond polyethylene and polypropylene) • Can be used to strengthen and protect: screws and nuts, knots on fishing lines, plastic tools • For repairing: jewelry, decorations and toys, mock-ups, rubber hoses, models • Does not fill in cavities • Contains ethyl cyanoacrylate

Code	Volume (ml)	
42038	2	240

### 2 KROPELKA INSTANT GLUE GEL

• КЛЕЙ МОМЕНТАЛЬНЫЙ КРОПЕЛКА ГЕЛЬ  
• KROPELKA INSTANT GELKLEBER



- For all types of surfaces, both smooth and porous • Does not splash, spill or drip • Gel form eliminates dripping, allows glue to be applied from the bottom and on vertical surfaces • Allows time to correct the positioning of glued elements immediately after their joining • An applied drop remains at the selected spot, which enables careful and precise dosing • Used for instant bonding of: metal, leather, porcelain, wood, rubber, faience, ceramics, plastic (does not bond polyethylene and polypropylene) • Can be used to strengthen and protect: screws and nuts, knots on fishing lines, plastic tools
- For repairing: jewelry, decorations and toys, mock-ups, rubber hoses, models
- Does not fill in cavities • Contains ethyl cyanoacrylate

Code	Weight (g)	
42039	3	240

### 3 METALLIC POXIPOL GLUE

• КЛЕЙ ПОКСИЛИН МЕТАЛЛИЧЕСКИЙ • METALLIC



120°C

- An excellent adhesive with the characteristics of a metallic binder • Can be applied in any thickness, does not shrink, does not stretch, does not deform • Does not flake and does not flow from vertical surfaces • Does not contain any solvents
- Upon setting it turns into a durable material that can be drilled, filed down with a file or a hand saw, suitable for processing with ordinary tools • Resistant to water, oils and temperatures up to 120 °C depending on the application • Used for bonding metal, glass, rubber, wood, concrete, ceramics, etc. • Used to repair cars, furniture, toys, sports goods, tableware • Can be used for mounting hooks and pegs in a wall, tool handles etc. • Can be used to seal leaks in pipes, seal metals and tanks for fuel, water, oil, etc.

Code	Volume (ml)	Weight (g)	
42042	14	21	240

### 4 TRANSPARENT POXIPOL GLUE

• КЛЕЙ ПОКСИЛИН БЕСЦВЕТНЫЙ  
• TRANSPARENT POXIPOL KLEBER



120°C

- An excellent adhesive with the characteristics of a metallic binder • Can be applied in any thickness, does not shrink, does not stretch, does not deform • Does not flake and does not flow from vertical surfaces • Does not contain any solvents
- Upon setting it turns into a durable material that can be drilled, filed down with a file or a hand saw, suitable for processing with ordinary tools • Resistant to water, oils and temperatures up to 120 °C depending on the application • Used for bonding metal, glass, rubber, wood, concrete, ceramics, etc. • Used to repair cars, furniture, toys, sports goods, tableware • Can be used for mounting hooks and pegs in a wall, tool handles etc. • Can be used to seal leaks in pipes, seal metals and tanks for fuel, water, oil, etc.

Code	Volume (ml)	Weight (g)	
42043	14	16	240

### 5 SYNTHETIC OŚMIORNICZKA GLUE

• СИНТЕТИЧЕСКИЙ КЛЕЙ • SYNTHETIKKLEBER OSMIORNICZKA



-20°C  
+70°C

- Adhesive for bonding: wood, stone, marble, ceramics, tiles, carpets, bricks, concrete, glass, cork, stonework, gypsum, metal and some plastics. • Once hardened the product is resistant to temperatures between -20 °C and 70 °C. • Not suitable for permanently submerged elements • Does not bond polyethylene and polypropylene • Suitable for indoor and outdoor use • Solvent-free
- Does not contain corrosive substances

Code	Weight (g)	
42044	50	72
42045	120	48

### 6 POXILINA GLUE

• КЛЕЙ ДВУХКОМПОНЕНТНЫЙ ПОКСИЛИНА • POXILINA KLEBER



- Used for sealing, filling, reconstruction, repair and bonding: metals, wood, concrete, glass, marble, etc. • Used as a plastic mass • Reaches a hardness of metal within 10 minutes • Poxilina is a product with extraordinary sealing properties
- Applied cold has a plastic consistency and after setting reaches the hardness of metal
- After 1 hour, it can be filed, drilled and machined with basic tools • Does not shrink and does not stretch, is a good electrical insulator, does not contain solvents • Does not lose its properties over time, offers very good resistance to temperature, is not negatively affected by cold, heat or water
- For sealing and repairing pipes, all types of sanitary equipment, fuel tanks, etc. • Do not use to repair gas pipes

Code	Weight (g)	
42047	70	240

### 1 CYJANOPAN GLUE

• КЛЕЙ СУЈАНОРАН • СУЈАНОРАН-КЛЕВЕР



- Cyjanopan is a single-component, no-thinner cyanoacrylic glue • Seam curing consists in a rapid polymerization caused by the moisture present on the glued components
- Cyanopan can be used for binding metals, rubber, glass, ceramics, wood and plastic (except for PE, PP, PTFE and silicones)

Code	Application for joint types	Weight (g)		
42001	flexible	2	x	50/1000
42002	rigid	2	x	50/1000

### 2 UNIVERSAL BUTAPREN GLUE

• КЛЕЙ БУТАПРЕН ДЛЯ КОЖЕВЕННОЙ ПРОМЫШЛЕННОСТИ И СТРОИТЕЛЬСТВА • КЛЕВЕР БУТАПРЕН



- Traditional Butapren glue • Application: for binding leather, rubber, plastic, cardboard and textiles • Delivered in tubes in a collective package

Code	Volume (ml)	
42017	40	100

### 3 GLUE FOR WOODS

• СТОЛЯРНЫЙ КЛЕЙ • HOLZLEIM



- Traditional WIKOL glue • Application: for gluing wood, wood-based materials, laminates • Delivered in tubes in a collective package

Code	Volume (ml)	
42014	40	100

### 4 METAL EPOXY GLUE

• ЭПОКСИДНЫЙ ДВУХКОМПОНЕНТНЫЙ КЛЕЙ ДЛЯ МЕТАЛЛА • ЭРОXY-KLEBER



100°C

- METAL EPOXY GLUE is a two-component epoxy glue curing in 5 minutes (A component - black, B component - grey) • Efficiently binds ceramic, glass, metal and certain plastic surfaces • When cured, resistant to water and most solvents • Offers good machining properties, resistance up to 100°C

Code	Weight (g)		
42020	2 x 20	x	12

### 5 GLUE FOR SHOES

• КЛЕЙ ПОЛИУРЕТАНОВЫЙ ОВУ • POLYURETHANKLEBER OBU



- OBU is a polyurethane glue for professional repair of shoes, and also for gluing leather, most rubber types, wood, certain plastic types, except for polyethylene, polypropylene, PTFE, silicon rubber etc. • The joints made with OBU are resistant to water, certain chemicals, oils and grease

Code	Volume (ml)		
42018	15	x	50

### 6 GLUE FOR SHOES

• КЛЕЙ ПОЛИУРЕТАНОВЫЙ ОВУ • POLYURETHANKLEBER OBU



- OBU is a polyurethane glue for professional repair of shoes, and also for gluing leather, most rubber types, wood, certain plastic types, except for polyethylene, polypropylene, PTFE, silicon rubber etc. • The joints made with OBU are resistant to water, certain chemicals, oils and grease

Code	Volume (ml)		
42019	60	x	24

### 7 HI-TEMP SILICONE GASKET

• СИЛИКОНОВЫЙ ГЕРМЕТИК RED SILICONE • SILIKONDICHTSTOFF



-60°C  
+300°C

- RED SILICONE is a silicone sealant for sealing engine components, e.g. oil sumps, bodies, valve covers, and also for protection and sealing • Temp. range -60 to 300°C, colour: red

Code	Weight (g)		
42040	85	x	12

PROLINE  
LAHTI PRO  
MEGA  
JUCO  
OTHER BRANDS  
ENDI  
KLINGSPOR  
EXPRESS  
ACTION CAN  
TRYTON  
VULCAN

**1 METAL EPOXY MASTIC GLUE**

- МЕТАЛЛИЧЕСКАЯ ЭПОКСИДНАЯ ГРУНТОВКА PLASTELIT
- KLEBER ZUM VERBINDEN VON METALL MIT GLAS, KERAMIK



260°C

- PLASTELIT is a quick-curing two-component epoxy mastic glue, for filling holes in metal, ceramic surfaces, and for gluing and sealing
- Binds metals, ceramics, glass and certain plastic types • Resistant to temp. up to 260°C • The joints, thanks to their high hardness, can be machined

Code	Weight (g)		
42051	50	x	20

**2 RADIATOR SEALANT**

- ГЕРМЕТИК ДЛЯ РАДИАТОРА SILVER SEAL
- DICHTSTOFF FÜR KÜHLUNGSANLAGEN



- SILVER SEAL – cooling system sealant
- Stops leaks from the radiator, engine block, cylinder head and at the drain plugs

Code	Weight (g)		
42050	20	x	12

**3 SOLDERING IRONS**

- ПАЯЛЬНИКИ • WIDERSTANDSLÖTMASCHINEN



- Voltage 230 V
- 60007 - with two power ranges

Code	Power (W)	
60001	18	1
60005	25	1
60002	40	1
60006	60	1
60007	60/30	1

**4 SOLDERING IRONS**

- ПАЯЛЬНИКИ • АТРАМИНІАІ ЛІТУОКІАІ



- Voltage 230 V
- Soldering guns with two power ranges

Code	Power (W)	
60008	200/100	1
60009	300/150	1
60011	400/200	1

**5 SOLDERING GUN**

- ТРАНСФОРМАТОРНЫЕ ПАЯЛЬНИКИ • TRANSFORMATORLÖTMASCHINEN



- Voltage 230V • Soldering guns with a bulb lighting the work site • The set includes 3 bits • Delivered in cardboard box
- Type A – all-purpose soldering gun for repairs and DIY household works
- Type B – soldering gun for binding conductors and components with large profiles, useful especially for wiring works
- Type C – all-purpose soldering gun with two power values, designed for service and installation works in the electrical engineering and electronic field, recommended for professionals
- Type 4 – new generation soldering gun, with aesthetic and durable casing, with a durable bit made from special alloy (compatible also with copper bits without the need to change work parameters). Recommended especially for service works thanks to its small size and weight, and large range of applications

Code	Type	Power (W)	
60103	4A	40/65	1
60104	6A	75	1
60105	6B	100	1
60102	6C	55/75	1
60101	4	65	1



### 1 THERMAL KNIFE

• НОЖ ТЕРМИЧЕСКИЙ • THERMOMESSER



- Voltage 230V 50Hz • Max. blade temp. 250/320°C • Class I device • Blade length 230mm • The device for cutting styrofoam panels 1-18 cm thick when installing thermal insulation on buildings and during other works where styrofoam panels are used
- Its advantage is its light weight when compared with low-voltage transformer knives

Code	Power [W]	Weight [kg]	
60012	90/180	0.5	1

### 2 PVC PIPE WELDING MACHINE

• РУЧНЫЕ АППАРАТЫ ДЛЯ СВАРКИ ПЛАСТИКОВЫХ ТРУБ И ФИТИНГОВ • ПЛАСТИКОВЫХ ТРУБ И ФИТИНГОВ



- Voltage 230 V • Machine for welding pipes, thermoplastic profiles in water and central heating systems • Temperature control range 50 - 300°C • The set includes 2 bolts for mounting heating stones, stand
- Delivered in cardboard box • Delivered without heating tips

Code	Power [W]	Weight [kg]	
60015	350/700	1.2	1
60016	750/1300	1.5	1

### 3 HEATING TIPS

• СВАРОЧНЫЕ НАСАДКИ • HEIZSPITZEN



- For welding unit 60015 and 60016
- Covered with high-grade industrial PTFE resistant to abrasion • Sold in a set: male with female

Code	Diameter [mm]	
60020	16	1
60021	20	1
60022	25	1
60023	32	1
60024	40	1
60025	50	1
60026	63	1
60027	75	1
60028	90	1

### 4 MOUNTING SET FOR STONE HEATERS

• МОНТАЖНЫЙ БОЛТ ДЛЯ СВАРОЧНЫХ НАСАДОК  
• SCHRAUBE MIT BUCHSE ZUR BEFESTIGUNG VON HEIZSPITZEN AN STUMPFSCHEISSMASCHINEN



- For welding units 60015 and 60016

Code	
60018	1

### 5 FLUX

• КАНИФОЛЬ • KOLOPHONIUM



- Melting temp. 80-110°C
- In a metal box

Code	Weight [g]	
60412	45	50

### 6 AMASAN SOLDERING FLUIDS

• ФЛЮСЫ ДЛЯ ПАЙКИ • LÖTLÜSSIGKEIT



- High-activity ZWS soldering fluid is designed for brazing of highly oxidized steel sheets and rectified zinc • Used for soldering gutters, roof coverings made from galvanised steel sheets etc. • ZWS fluid solves oxides, without leaving stains and damaging zinc which retains its resistance to corrosion
- Has a certificate of the National Institute of Hygiene

Code	Weight [g]	
60421	250	12
60422	1000	12

### 7 AMASAN SOLDERING GREASE

• ФЛЮС ДЛЯ ПАЙКИ • LÖTFETT



- The soldering grease (flux) is designed for brazing copper, brass, galvanised steel sheets and steel sheet whitening

Code	Weight [g]	
60432	50	200

### 8 SAL AMMONIAC TINNING BLOCK

• ФЛЮС ДЛЯ ПАЙКИ • GEPRESSTES SALMIAK



- Designed for removing oxides from soldering gun bits • For this purpose, press a hot bit to ammonium chloride, thanks to which melting ammonium chloride will clean the bit event if it is very dirty and overheated • Cold ammonium chloride becomes solid again

Code	Size [mm]	
60442	65 x 45 x 40	100

**1 UNIVERSAL GREASE**

• СМАЗКА УНИВЕРСАЛЬНАЯ • UNIVERSALSCHMIERMITTEL



-25°C  
+125°C



- For greasing rolling bearings, slide bearings, joints and guides working under heavy loads
- Resistant to cold water washing • Plastic syringe-type dispenser

Code	Volume (ml)	
42239	70	12

**4 LUBRICATING OIL**

• МАШИНОЕ МАСЛО • MAMASCHINENÖL



0°C  
+60°C



- Designed for low-load parts of industrial machines - bearings, guides, mechanical gears, spindles and auxiliary friction nodes, as well as locks, hinges, household appliances
- Plastic syringe-type dispenser

Code	Volume (ml)	
42237	70	12

**7 COPPER GREASE**

• СМАЗКА МЕДНАЯ • КУКУРPFERFÖL



-20°C  
+100°C



- Designed for threaded connections to prevent seizing, bake-on and jamming
- Prevents corrosion • Ensures perfect lubrication, prevents abrasive wear • Seals against impurities • Plastic syringe-type dispenser

Code	Volume (ml)	
42242	70	12

**2 MACHINERY VASELINE**

• ТЕХНИЧЕСКИЙ ВАЗЕЛИН • TETECHNISCHE VASELINE



0°C  
+30°C



- Designed for lubricating low-load friction nodes, greasing rubber and leather gaskets, protecting metal parts from corrosion, and as an agent protecting from rubber gasket adhesion and freezing • Plastic syringe-type dispenser

Code	Volume (ml)	
42235	70	12

**5 GRAPHITE GREASE**

• ГРАФИТОВАЯ СМАЗКА • GRAPHITFETT



-20°C  
+50°C



- Designed for greasing shock absorber blades, threads, bolts and open gears and worm gears, chains and other highly loaded friction nodes • Resistant to cold water washing
- Plastic syringe-type dispenser

Code	Volume (ml)	
42238	70	12

**8 SYNTHETIC GREASE**

• СИНТЕТИЧЕСКАЯ СМАЗКА • UNIVERSALSCHMIERMITTEL



-20°C  
+200°C



- Designed for greasing highly loaded, fastrotating rolling bearing and slide bearings, and other mechanisms • Not soluble in water • Plastic syringe-type dispenser

Code	Volume (ml)	
42243	70	12

**3 SEMI-LIQUID GREASE**

• МАШИНОЕ СМАЗКА • MAMASCHINENFETT



-30°C  
+130°C



- Designed for lubricating rolling bearings and slide bearings, joints and guides • Can be used for heavy loads • Resistant to cold water washing • Provides protection against corrosion • Plastic syringe-type dispenser

Code	Volume (ml)	
42236	70	12

**6 SILICON OIL**

• МАСЛО СИЛИКОНОВОЕ • SISILIKONÖL



0°C  
+55°C



- Designed for greasing light-load parts
- Plastic syringe-type dispenser

Code	Volume (ml)	
42241	70	12

**9 SOLID WIRE SOLDER**

• ТРУБЧАТЫЕ ПРИПОИ С ФЛЮСОМ • LOT



- Melting temp. 183-190°C
- LC 60 solder in reels of 100 g
- With flux SW26



Code	Diameter (mm)		
60310	0.56		30
60311	0.7		30
60312	1.0		30
60313	1.5		30
60314	2.0		30
60315	2.5		30
60316	3.0		30

**1 SOLID WIRE SOLDER**

- ТРУБЧАТЫЕ ПРИПОИ С ФЛЮСОМ В ТУБЕ
- LOT



- Melting temp. 183-190°C
- LC 60 solder in vials – 3 m long
- With flux SW26
- Sold in packs of 1 pc

Code	Diameter (mm)		
60319	1.0		25/600

**2 SOLID BAR SOLDER**

- ПРИПОЙ В ПРУТКАХ • LOT



- In sticks with square profile
- Sold in packs of 1 pc

Code	Size (mm)	
60351	7 x 7 x 350	176

**3 GAS LIGHTER - PIEZO IGNITION**

- ЗАЖИГАЛКА ПЬЕЗОЭЛЕКТРИЧЕСКАЯ
- ZÜNDER MAX GH19 GERADE, PIEZO-ZÜNDUNG



- Lighter with liquefied gas with piezoelectric ignition • Type MAX GH17

Code	Length (mm)	
42313	227	16/192

**4 GAS LIGHTER - PIEZO IGNITION**

- ЗАЖИГАЛКА ПЬЕЗОЭЛЕКТРИЧЕСКАЯ, СКЛАДНАЯ
- ZÜNDER MAX GH19 KLAPPBAR, PIEZO-ZÜNDUNG



- Lighter with liquefied gas with piezoelectric ignition • The gas can be supplied with 42308

Code	Length (mm)	
42311	188	16/384

**5 REFLECTIVE WHITE-RED ROAD BOLLARDS**

- ДОРОЖНЫЕ КОНУСЫ БЕЛО- КРАСНЫЕ СВЕТООТРАЖАЮЩИЕ
- REFLEKTIER ENDE VERKEHRSKEGEL WEISS-ROT



- Reflective plastic cones with red-paint stripes
- Store only in vertical position

Code	Height (cm)	
35581	40	1
35583	50	1

**6 REFLECTIVE FLOURESCENT WHITE-RED ROAD BOLLARDS**

- ДОРОЖНЫЕ КОНУСЫ БЕЛО-КРАСНЫЕ СВЕТООТРАЖАЮЩИЕ ФЛУОРЕСЦЕНТНЫЕ • REFLEKTIERENDE VERKEHRSKEGEL WEISS-ORANGE FLUORESZIEREND



- The cones made from fluorescent orange plastic, with white reflective strips • Store only in vertical position

Code	Height (cm)	
35586	40	1
35587	50	1

**7 TOOL BOXES**

- ПЛАСТМАССОВЫЕ ЯЩИКИ ДЛЯ ИНСТРУМЕНТА
- WERKZEUGKÄSTEN



- Plastic with removable tray

Code	Size (mm)	
35512	300 (12")	300
35516	400 (16")	120
35519	500 (20")	56

**8 STORAGE BOX**

- ОРГАНАЙЗЕР • PLASTIKBOX



- Possibility to change divider configuration
- Highly versatile application

Code	Size (mm)	Quantity of dividers	
35527	460 x 325 x 80	16	125

**9 STORAGE BOXES**

- ПЛАСТИКОВЫЕ КОРОБКИ - ОРГАНАЙЗЕРЫ • PLASTIKBOX



- Ideal for storage of small parts
- Transparent cover on hinges

Code	Size (mm)	Quantity of dividers	
35522	200 x 145 x 35	7	1920
35523	300 x 220 x 55	10	455
35524	345 x 245 x 60	11	270

**1 BIN BOXES**

• СКЛАДСКИЕ КОНТЕЙНЕРЫ • LAGERBEHÄLTER



- Plastic
- Possibility to create storied modules and hang on a strip 35529

Code	Size (mm)	Colour	
35530C	111 x 165 x 75	red	1500
35530Z	111 x 165 x 75	green	1500
35530N	111 x 165 x 75	blue	1500
35531C	155 x 240 x 125	red	408
35531Z	155 x 240 x 125	green	408
35531N	155 x 240 x 125	blue	408
35532C	221 x 350 x 165	red	156
35532Z	221 x 350 x 165	green	156
35532N	221 x 350 x 165	blue	156

**2 PANEL FOR BIN BOXES**

• НАСТЕННАЯ РЕЙКА ДЛЯ ЗАВЕШЕНИЯ СКЛАДСКИХ КОНТЕЙНЕРОВ • HÄNGELEISTE FÜR LAGERBEHÄLTER



- For hanging and fixing bin boxes in a row

Code	Size (mm)	
35529	495 x 40	100

**3 DRAWER STORAGE CABINETS**

• ПЛАСТИКОВЫЕ ШКАФЧИКИ С ВЫДВИЖНЫМИ ЯЩИКАМИ • SCHUBLADENSCHRÄNKE



- Plastic body and drawers
- Modular structure enabling to connect different cabinets
- 35801 - colourful plastic drawers
- 35802 - transparent drawers enabling to install additional dividers (sold separately)

Code	Size (mm)	Quantity of drawers	
35801	213 x 304 x 125	10	8
35802	213 x 304 x 125	10	8

**4 DRAWER STORAGE CABINETS**

• ПЛАСТИКОВЫЕ ШКАФЧИКИ С ВЫДВИЖНЫМИ ЯЩИКАМИ • SCHUBLADENSCHRÄNKE



- Plastic
- Modular structure enabling to connect different cabinets
- Sold empty

Code	Size (mm)	Quantity of drawers	
35320	220 x 160 x 70	16	16
35221	320 x 220 x 70	32	8

**5 DRAWER STORAGE CABINETS**

• МЕТАЛЛИЧЕСКИЕ ШКАФЧИКИ С ВЫДВИЖНЫМИ ЯЩИКАМИ • SCHUBLADENSCHRÄNKE



- Metal casing
- Plastic drawers
- Modular structure enabling to connect different cabinets

Code	Size (mm)	Quantity of drawers	
35830	300 x 280 x 145	30 (5 x 6)	12
35860	300 x 550 x 145	60 (5 x 12)	1

**6 DRAWER STORAGE CABINET**

• ПЛАСТИКОВЫЕ ШКАФЧИКИ С ВЫДВИЖНЫМИ ЯЩИКАМИ • PLASTIKSCHRÄNKE MIT SCHUBLADEN



- External diameters: 230 x 125 x 140 mm
- Modular structure, can be connected in any way
- Sold empty

Code	Quantity of drawers	
35803	2	10
35804	4	10
35805	6	10
35806	12	10

**7 TOOL CASE**

• ПЛАСТИКОВЫЙ КЕЙС ДЛЯ ЭЛЕКТРОИНСТРУМЕНТОВ • KOFFER FÜR ELEKTROGERÄTE



- Plastic

Code	Size (mm)	
35513	300 x 400 x 120	112



**1 TOOL TRAY**

- ПЛАСТИКОВЫЙ КОНТЕЙНЕР С ОТКРЫТОЙ РУЧКОЙ
- OFFENER BEHÄLTER MIT GRIFF



- Plastic

Code	Size [mm]	
35707	400 x 300 x 180	175

**2 2 IN 1 ORGANISERS SET**

- НАБОР ОРГАНИЗАТОРОВ 2 В 1 • PLASTIKBOX SET



- Set of two transparent organisers with an orange handle
- Made of high quality materials
- Trays for small parts inside
- Strong closing
- For storage of small as well as bigger parts
- Handle for easy carrying

Code	Dimensions [mm]	
35711	235 x 190 x 160	18

**3 ORGANISERS**

- ОРГАНИЗАЙЗЕРЫ • ORGANIZER



- Made of high quality materials
- dividers inside
- Strong closing
- Ideal for workshop and at home
- For storage of small as well as bigger parts
- Handle for easy carrying

Code	Dimensions [mm]	Quantity of dividers	
35720	245 x 150 x 85	5	38
35721	295 x 195 x 85	5	24
35733	359 x 238 x 85	6	16
35734	400 x 298 x 85	6	12

**4 ORGANISER**

- ОРГАНИЗАЙЗЕР • PLASTIKBOX



- Made of high quality materials
- dividers inside
- strong closing
- Ideal for workshop and at home
- For storage of small as well as bigger parts.

Code	Dimensions [mm]	Quantity of dividers	
35732	198 x 117 x 45	5	45

**5 COLORFUL STORAGE BOXES SET**

- ОРГАНИЗАТОРЫ НАБОР • PLASTIKBOX SET



- Set of organizers in three colours - green, violet, transparent
- Made of high quality materials
- dividers inside
- For storage of small parts

Code	Dimensions [mm]	
35780	1 x 280/175/42 mm; 2 x 184/130/38 mm	16

**6 GARDEN RAKE**

- ГРАБЛИ МЕТАЛИЧЕСКИЕ
- METALLHARKE



- Coated metal rake
- Ergonomic, bent, metal handle
- Plastic holder

Code	Tooth number	Length [mm]	Width [mm]	
12278	16	1500	410	5

**7 GARDEN RAKES**

- ГРАБЛИ • GRIEBLYS



- Coated metal head
- Handle socket riveted to the head

Code	Tooth number	Handle length [cm]	
12276	14	110	5
12385	12	130	5
12386	14	130	5
12387	16	130	5
12389	18	130	5

**8 PLASTIK GARDEN RAKE WITH WOODEN HANDLE**

- ГРАБЛИ ПЛАСТМАССОВЫЕ
- PLPLASTIKHARKE



- Beechwood handle
- Handle length 130 cm
- Handle dia. 28mm
- Rake made from plastic
- No. of teeth - 20

Code	Width [mm]	
12263	460	5

**9 PLASTIK GARDEN RAKE WITH WOODEN HANDLE**

- ГРАБЛИ ПЛАСТМАССОВЫЕ С ЧЕРЕНКОМ
- PLPLASTIKHARKE MIT STIEL



- Beechwood handle
- Handle length 120cm
- Handle dia. 22mm
- Rake made from plastic
- No. of teeth - 23

Code	Width [mm]	
12264	420	5

**10 PLASTIC GARDEN RAKE WITHOUT STEM**

- ГРАБЛИ ПЛАСТМАССОВЫЕ
- PLASTIKHARKE OHNE STIEL



- Handles: 12945, 12922, 12923, 12924

Code	Tooth number	Width [mm]	
12252	20	460	20

**1 PLASTIC GARDEN RAKE WITHOUT STEM**

• ГРАБЛИ ПЛАСТМАССОВЫЕ • PLASTIKHARKE OHNE STIEL



- Tooth length 80 mm
- Handles: 12945, 12922, 12923, 12924

Code	Tooth number	Width (mm)	
12251	18	600	20

**2 PLASTIC GARDEN RAKE WITHOUT STEM**

• ГРАБЛИ ПЛАСТМАССОВЫЕ • PLASTIKHARKE OHNE STIEL



- Handles: 12941, 12942, 12943

Code	Tooth number	Width (mm)	
12253	23	420	25

**3 PLASTIC GARDEN RAKE WITHOUT STEM**

• ГРАБЛИ ПЛАСТМАССОВЫЕ • PLASTIKHARKE OHNE STIEL



- Handles: 12945, 12922, 12923, 12924

Code	Tooth number	Width (mm)	Head colour	
12258	24	610	Coloured	20
12259	24	610	czarne	20

**4 PLASTIC GARDEN RAKE WITHOUT STEM**

• ГРАБЛИ ПЛАСТМАССОВЫЕ • PLASTIKHARKE OHNE STIEL

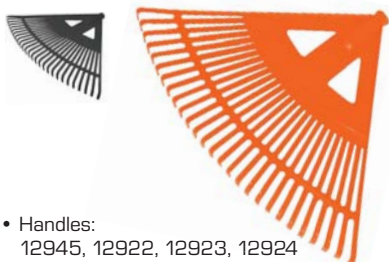

- Handles: 12945, 12922, 12923, 12924

Code	Tooth number	Width (mm)	Head colour	
12254	27	430	Coloured	20
12255	27	430	czarne	20
12256	27	580	Coloured	20
12257	27	580	czarne	20

**5 PLASTIC GARDEN RAKE WITHOUT STEM**

• ГРАБЛИ ПЛАСТМАССОВЫЕ • PLASTIKHARKE OHNE STIEL

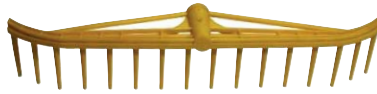

- Tooth length 80 mm
- Handles: 12945, 12922, 12923, 12924

Code	Tooth number	Width (mm)	
12250	16	550	20

**6 REINFORCED RAKE WITHOUT STEM**

• ГРАБЛИ УСИЛЕННЫЕ • VERSTÄRKTE HARKE OHNE STIEL



- Metal rake without handle
- Handles: 12945, 12922, 12923, 12924

Code	Width (mm)	Height (mm)	Tooth number	
12383	360	80	14	10
12384	410	80	16	10

**7 WIRE RAKE WITHOUT STEM**

• ГРАБЛИ ПРОВОЛОЧНЫЕ • DRANTHARKE OHNE STIEL

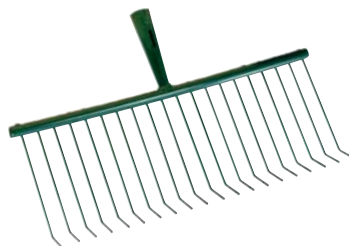

- Metal rake without handle
- Handles: 12945, 12922, 12923, 12924

Code	Width (mm)	Height (mm)	Tooth number	
12382	405	170	20	5

**8 PLASTIC WATERING CANS**

• ПЛАСТИКОВЫЕ ЛЕЙКИ • GIESSKANNEN AUS KUNSTSTOFF



Code	Volume (l)	Colour	
35111	5		1
35112	5		1
35121	10		1
35122	10		1

**9 VEGETABLE SHOVEL WITH WOOD STEM**

• СОВОК ДЛЯ ОВОЩЕЙ • GEMÜSESCHAUFEL

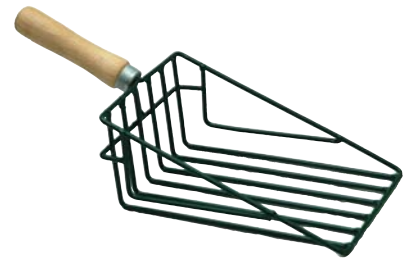

- Wooden handle

Code	Width (mm)	Length (mm)	
12279	150	350	5

**10 COMPOST FORK WITH WOOD STEM**• ВИЛЫ ДЛЯ КОМПОСТА  
• HEUGABEL ZUM GRABEN

- Wooden handle with T holder; 100 cm long

Code	Width (mm)	Height of head	
12281	200	255	5

**1 COMPOST FORK**

• ВИЛЫ ДЛЯ КОПАНИЯ • HEUGABEL ZUM GRABEN

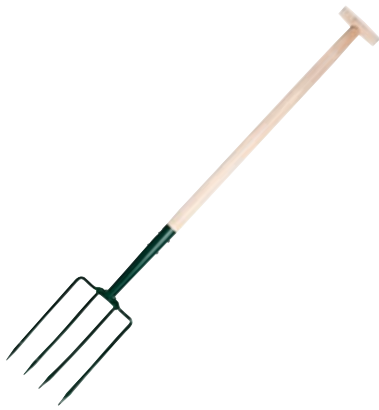

- Wooden handle with T holder 90 cm long
- The handle fixed to the head bushing with a single rivet

Code	Width (mm)	Height of head	
12289	195	280	5

**2 PITCHFORK**

• ВИЛЫ САДОВЫЕ • HEUGABEL

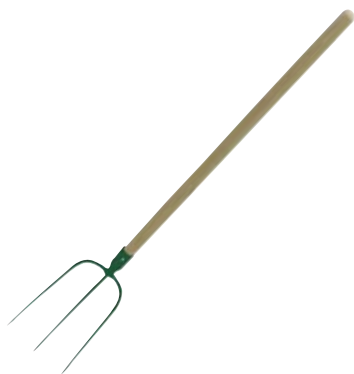

- Straight wooden handle, 100 cm long

Code	Width (mm)	Height of head	Tooth number	
12283	230	330	3	5
12284	230	305	4	5

**3 POTATOE FORK**

• ВИЛЫ ДЛЯ КОПАНИЯ КАРТОФЕЛЯ • KARTOFFELHEUGABEL



- Wooden handle with T holder, 100 cm long
- Teeth with balls to protect the material moved from damage

Code	Width (mm)	Height of head	
12286	240	340	5

**4 RUBBLE FORK WITH WOOD STEM**

• ВИЛЫ ДЛЯ КАМНЕЙ • STEINHEUGABEL



- Wooden handle with T holder, 100 cm long
- Teeth with balls to facilitate material landing

Code	Width (mm)	Height of head	
12288	275	370	5

**5 HOE**

• МОТЫГА • HACKE



- Wooden handle, 110 cm long

Code	Width (mm)	
12291	160	5

**6 SIMPLE HOE WITH FORK**

• МОТЫГА С ГРАБЛЯМИ • GERADE HACKE MIT ZINKEN



- Wooden handle, 110 cm long

Code	Width (mm)	Height of head	
12295	50	190	5

**7 CORDIAL HOE WITH FORK**

• МОТЫГА С ГРАБЛЯМИ • HACKE HERZFÖRMIG MIT ZINKEN



- Wooden handle, 110 cm long

Code	Width (mm)	Height of head	
12296	50	190	5

**8 AUGERS**

• БУРЫ • FÖRDERSCHECKEN



- For drilling holes in soil
- Ergonomic plastic handles

Code	Head diameter [mm]	Colour	
40127	90	green	1
40123	170	black	1
40125	250	black	1
40124	170	random	1
40126	250	random	1

**9 SPIKES FOR LAWN ROLLER**

• ШИПЫ ДЛЯ КАТКА ДЛЯ УКЛАТЫВАНИЯ ГАЗОНА • STACHELN FÜR RASENVALZE



- Metal, random colour
- To be installed on rollers 40115 or 40118
- When installed on the roller, for soil fertilising, lawn aerating

Code	Diameter [mm]	Length of spikes [mm]	
40119	280	80	5

**1 LAWN ROLLERS**

• КАТКИ ДЛЯ УКАТЫВАНИЯ ГАЗОНА • RASENWALZEN



- Metal, random colour • For levelling the ground, soil • Can be loaded with water
- Rubber plug • Possibility to install spikes 40119 sold separately • Delivered for self-assembly

Code	Head diameter (mm)	Width (mm)	
40115	280	500	1
40118	280	800	1

**2 COALCAN**

• КОВШИ ДЛЯ УГЛЯ И ЗОЛЫ • KÖHLEBEHÄLTER



- Designed for: manual handling of coal, coke, wood and other solid fuel, as well as cold cinder and other waste left by burning in stoves, fireplaces, coal ovens and grills, where solid fuels are used • Made from profiled and coated steel sheet

Code	Width x length x height (mm)	
12796	210 x 395 x 190	3
12798	220 x 450 x 230	3

**3 SMALL DUSTPAN**

• СОВОК МАЛЫЙ • SCHAUFEL KLEIN



- Designed for: stoves, fireplaces, coal-fired ovens or grills where solid fuel is used, when adding or removing fuel, cinder or leftovers
- Can be used also for litter, dust and other small solid waste • Wooden handle 22 mm long, dia. 300 mm • Made from profiled and coated steel sheet

Code	Width (mm)	
12791	100	10

**4 DUSTPANS**

• СОВКИ СРЕДНИЕ • SCHAUFELN



- Designed for: stoves, fireplaces, coal-fired ovens or grills where solid fuel is used, when adding or removing fuel, cinder or leftovers
- Can be used also for litter, dust and other small solid waste • Wooden handle dia. 22 mm and 300 mm long • Made from profiled and coated steel sheet

Code	Width (mm)	
12792	147	10
12793	175	5

**5 POKERS**

• КОЧЕРГИ • FEUERHAKEN



- Designed for stoves, fireplaces, coal-fired ovens or grills where solid fuels are used
- Made from profiled, coated rod with a wooden handle

Code	Length (mm)	
12745	500	5
12748	800	5

**6 WIRES FOR CHIMNEY BRUSH**

• РУЧКИ ДЛЯ ЕРШЕЙ • REINIGUNGSSTÄBE



- Designed for: after installing a flue brush, for cleaning boilers, but also fireplaces, coal-fired ovens or grills where solid fuels are used
- Made from steel wire dia. 7mm, with inner thread M12 on the one end, and a wooden handle on the other

Code	Length (mm)	
12766	600	5
12768	800	5
12770	1000	5

**7 CHIMNEY WIRES**

• СТАЛЬНЫЕ ТРОСЫ • SCHORNSTEINFEGERDRAHT



- Designed to be a component of chimneysweep sets for unblocking or cleaning of flues • Wire dia. 3.5mm with inner M12 thread

Code	Length (mm)	
12786	6.0	5
12787	8.0	5
12788	10.0	5
12789	12.0	5

**8 CHIMNEY BALLS**

• ГИРИ ДЛЯ ЧИСТКИ ДЫМОХОДОВ • SCHORNSTEINFEGERKUGEL



- Designed for cleaning flues and loading chimneysweep sets with brushes • The balls have an ear for connecting with a chimneysweep wire or brush • Weight tolerance +/- 10%

Code	Weight (kg)	
12781	0,75	1
12783	1,50	1
12785	3,00	1

**9 BRUSHES FOR CENTRAL HEATING**

 • ЩЕТКИ - ЕРШИ ДЛЯ ТЕПЛОБМЕННИКА  
 • REINIGUNGSBÜRSTEN FÜR HEIZUNGSANLAGEN

- Designed for: after installing a chimneysweep set, for cleaning boilers, but also fireplaces, coal-fired ovens or grills where solid fuels are used • Made from resilient steel wire dia. 0.35mm, the core made from two twisted wires dia. 3.5mm, with M12 thread on one end, which can be attached a rod or wire for flue brushes

Code	Diameter (mm)	
12753	30	50
12754	40	50
12755	50	50
12756	60	35
12757	70	35
12758	80	30
12759	90	20
12760	100	20

**10 CHIMNEY BRUSH**

• ЩЕТКИ - ЕРШИ ДЛЯ ЧИСТКИ ДЫМОХОДОВ • REINIGUNGSBÜRSTEN FÜR KAMINE



- Designed especially for flue cleaning • Made from resilient steel wire dia. 0.50mm, the core made from two twisted wires dia. 3.5mm, on the one end with M12 thread which can be attached a rod or wire for the flue brush, on the other with an ear, opening dia. 7mm, where you can attach e.g. a chimneysweep ball, using an appropriate fixing component

Code	Diameter (mm)	
12772	120	60
12775	150	50
12777	175	30
12778	200	30

**ERDI**

snips



**1 STRAIGHT SNIPS**

• НОЖНИЦЫ ПО МЕТАЛЛУ • FORMSCHERE



- For short straight and shaped cuts with high angle rightwards and leftwards • Blades with micro-teeth preventing slipping • Straight

Code	Size (mm)	Type	
<b>17366</b>	240	straight	10

**4 PUNCH SNIPS**

 • НОЖНИЦЫ ПО МЕТАЛЛУ ДЛЯ ОТВЕРСТИЙ  
 • SCHERE FÜR ÖFFNUNGEN

- For short and shaped cuts

Code	Size (mm)	Type	
<b>17335</b>	250	right	5
<b>17337</b>	275	right	5
<b>17336</b>	250	left	5
<b>17338</b>	275	left	5

**2 AVATION SNIPS**

 • НОЖНИЦЫ ПО МЕТАЛЛУ ШАРНИРНЫЕ  
 • GELENKSCHERE

- For short and shaped cuts • Jointed structure makes work easier
- One blade with small teeth, preventing the cut material from slipping
- Ergonomic PVC holders • For cutting steel sheet 1.8 mm thick, stainless steel 1.2 mm

Code	Size (mm)	Type	
<b>17364</b>	240	right/ straight	5
<b>17365</b>	240	left/ straight	5

**5 STRAIGHT AND SHAPED CUTTING SNIPS**

 • НОЖНИЦЫ ПО МЕТАЛЛУ „ИДЕАЛ“  
 • SCHERE „IDEAL“

- Straight and shaped cutting snips

Code	Size (mm)	Type	
<b>17348</b>	280	right	5
<b>17349</b>	280	left	5

**3 BERLIN TYPE SNIPS**

 • ЛИСТОВЫЕ НОЖНИЦЫ ПО ЖЕСТИ (БЕРЛИНСКИЙ ТИП)  
 • BERLINER-SCHERE

- For long, straight cuts • Right

Code	Size (mm)	Type	
<b>17325</b>	250	straight	5

**6 PELICAN SNIPS**

• НОЖНИЦЫ ПО МЕТАЛЛУ „ПЕЛИКАН“ • SCHERE „PELIKAN“



- Recommended especially for long, straight cuts

Code	Size (mm)	Type	
<b>17350</b>	300	right	5
<b>17351</b>	300	left	5



PROLINE

LAHTI PRO

MEGA

JUCCO

OTHER BRANDS

**ERDI**

KLINGSPOR

EXPRESS

ACTION CAN

TRITON

VULCAN

# KLINGSPOR

abrasive belts  
abrasive discs  
cutting discs  
diamond discs  
flap discs  
grinding discs  
sanding sheets





### 1 SEGMENTED DIAMOND DISCS

- АЛМАЗНЫЕ ДИСКИ СЕГМЕНТНЫЕ
- DIAMANT-SEGMENTSCHLEIBEN



- DT600U • Hole 22.2mm • All-purpose
- High performance • Durable thanks to high-quality materials and diamond
- Smooth edges

Code	Diameter (mm)	Qty of teeth	Thickness x Height (mm)	
KL322631	125	15	2.4 x 9.0	1
KL322634	230	30	2.6 x 9.0	1

### 2 SEGMENTED DIAMOND DISC

- АЛМАЗНЫЕ ДИСКИ СЕГМЕНТНЫЕ
- DIAMANT-SEGMENTSCHLEIBEN



- DT300U • Hole 22.2mm • Universal product for all multi-purpose building materials • Good performance • Cost effective

Code	Diameter (mm)	Qty of teeth	Thickness x Height (mm)	
KL325346	125	8	1.6 x 7.0	1
KL325348	230	16	2.3 x 7.0	1

### 4 TURBO DIAMOND DISCS

- ДИСКИ АЛМАЗНЫЕ TURBO • URBO DIAMANTSCHLEIBEN



- DT 300 UT EXTRA • Hole 22.2 mm
- Universal purpose • Good performance
- Cost effective • Turbo cut for smooth edges without breaks

Code	Diameter (mm)	Thickness x Height (mm)	Max. number of turns [1/min.]	
KL325354	125	1.9 x 7.0	12200	1
KL325356	230	2.5 x 7.0	6600	1



### 3 CONTINUOUS DIAMOND DISC

- АЛМАЗНЫЙ ДИСК ПОЛНЫЙ
- DURCHGEHENDE DIAMANTSCHLEIBE



- DT 300 F EXTRA • Hole 22.2 mm
- Smooth edges when cutting ceramic tiles
- High-quality disc, cost effective

Code	Diameter (mm)	Thickness x Height (mm)	Max. number of turns [1/min.]	
KL325358	125	1.6 x 7.0	12200	1

### 5 GRINDING DIAMOND DISC

- АЛМАЗНЫЕ ДИСКИ ДЛЯ ШЛИФОВКИ
- DIAMANTSCHLEIFSCHEIBE



- DS 300 B EXTRA • Hole 22.2 mm
- Two-row cup grinding disc • Highly aggressive at low pressure • Excellent cost to quality rate • Max. number of turns [1/min]

Code	Diameter (mm)	Qty of teeth	Thickness x Height (mm)	
KL325362	125	20	7.0 x 5.5	1

PROLINE

LANIT PRO

MEGA

JUCO

OTHER BRANDS

ERDI

KLINGSPOR

EXPRESS

ACTION CAN

TRYTON

VULCAN

## 1 CUTTING DISCS FOR METAL

- ОТРЕЗНЫЕ ДИСКИ ДЛЯ РЕЗКИ МЕТАЛЛА KRONENFLEX
- TRENNSCHEIBE FÜR METALLE



- CONVEX DISCS
- Type A 980 TZ Disc only 0.8 mm thick cuts even hard materials, e.g. stainless steel sheets, ensuring precise, clean cuts, with hardly any fin, requiring only minimum extra machining
- The disc can be used for quick and safe machining of extremely hard or plastic materials
- The disc generates less heat than thicker discs
- For cutting stainless steel, steel, non-ferrous metals
- Delivered by several collective packagings

Code	Size (mm)	Hole (mm)	
KL322182	115 x 0.8	22,2	25
KL322183	125 x 0.8	22,2	25

## 2 CUTTING DISCS FOR METAL

- ОТРЕЗНЫЕ ДИСКИ ДЛЯ РЕЗКИ МЕТАЛЛА KRONENFLEX
- TRENNSCHEIBE FÜR METALLE



- FLAT DISCS
- Type Z 960 TX is a perfect disc for cutting hard and plastic materials, e.g. titanium or high-alloy steels
- Dedicated blend of grain with zirconium oxide guarantees continuous disc sharpening when cutting
- For cutting stainless steel, alloy steel, carbon steel, titanium
- Delivered by several collective packagings

Code	Size (mm)	Hole (mm)	
KL322184	115 x 1.0	22,2	25
KL322185	125 x 1.0	22,2	25

## 3 CUTTING DISCS FOR METAL

- ОТРЕЗНЫЕ ДИСКИ ДЛЯ РЕЗКИ МЕТАЛЛА KRONENFLEX
- TRENNSCHEIBE FÜR METALLE



- FLAT DISCS
- 960 TZ is the most all-purpose thin disc by Klingspor among all high-performance discs
- Optimised binder system ensures improved lifetime
- For cutting high-grade stainless steel and steel
- Delivered by several collective packagings

Code	Size (mm)	Hole (mm)	
KL322180	115 x 1.0	22,2	25
KL322181	125 x 1.0	22,2	25

## 4 CUTTING DISCS FOR METAL

- ОТРЕЗНЫЕ ДИСКИ ДЛЯ РЕЗКИ МЕТАЛЛА KRONENFLEX
- TRENNSCHEIBE FÜR METALLE



- FLAT DISCS
- A24 R SUPRA – high-performance discs for steel cutting
- Possible replacements: 45432A - KL13287  
45437A - KL13456  
45439A - KL13464

Code	Size (mm)	Hole (mm)	
45432A	115 x 2.5	22.2	25
KL13295	125 x 2.5	22.2	25
45437A	180 x 3.0	22.2	25
45439A	230 x 3.0	22.2	25
45509A	300 x 3.0	22.2	10
45087A	350 x 3.5	25.4	10
KL13536	350 x 3.5	32	10
45274A	400 x 4.5	32	10

## 5 CUTTING DISCS FOR METAL

- ОТРЕЗНЫЕ ДИСКИ ДЛЯ РЕЗКИ МЕТАЛЛА KRONENFLEX
- TRENNSCHEIBE FÜR METALLE



- A24 EXTRA – all-purpose discs to be used in any metal machining sector
- Possible replacement: 45447A - KL13490

Code	Size (mm)	Hole (mm)	
45447A	180 x 3.0	22.2	25
45449A	230 x 3.0	22.2	25

## 6 CUTTING DISCS FOR METAL

- ОТРЕЗНЫЕ ДИСКИ ДЛЯ РЕЗКИ МЕТАЛЛА KRONENFLEX
- TRENNSCHEIBE FÜR METALLE



- FLAT DISCS
- Type A60 EXTRA – all-purpose discs for metal cutting

Code	Size (mm)	Hole (mm)	
45466A	125 x 1.0	22.2	25
45467A	115 x 1.0	22.2	25

## 7 CUTTING DISCS FOR METAL

- ОТРЕЗНЫЕ ДИСКИ ДЛЯ РЕЗКИ МЕТАЛЛА KRONENFLEX
- TRENNSCHEIBE FÜR METALLE



- Type A 60 TZ SPECIAL
- FLAT DISCS
- Thin, high-performance steel cutting discs
- Highly durable, produce minimum waste and save energy
- Application - for cutting stainless and acid-resistant steel, for sheet metal work, for cutting thin metal sheets, thin-walled profiles and stainless steel, acid-proof pipes, non-ferrous metals, for cross-cutting metal bars and wires, as well as combined materials

Code	Size (mm)	Hole (mm)	
KL202400	115 x 1.0	22.2	25
KL202401	125 x 1.0	22.2	25

## 8 CUTTING DISCS FOR METAL

- ОТРЕЗНЫЕ ДИСКИ ДЛЯ РЕЗКИ МЕТАЛЛА KRONENFLEX
- TRENNSCHEIBE FÜR STAHL, SPEZIAL



- Type A 46 TZ SPECIAL
- FLAT DISCS
- Thin, high-performance discs for steel cutting
- Are highly durable, ensure minimum waste and energy savings
- Designed for - cutting stainless and acid-proof steel, for tinsworks, for cutting thin metal sheets, thin-walled sections and pipes made from stainless and acid-proof steel, non-ferrous metals, for cutting crosswise metal bars and wires, as well as combination materials

Code	Size (mm)	Hole (mm)	
45452A	115 x 1.6	22.2	25
KL187171	125 x 1.6	22.2	25
KL221161	180 x 1.6	22.2	25
KL224084	230 x 1.9	22.2	25

### 1 CUTTING DISCS FOR METAL

- ОТРЕЗНЫЕ ДИСКИ ДЛЯ РЕЗКИ МЕТАЛЛА KRONENFLEX
- TRENNSCHEIBE FÜR METALLE



- CONVEX DISCS
- A24 R/36 SPECIAL – high-performance discs for cutting stainless and acidproof steel

Code	Size (mm)	Hole (mm)	☐
45343A	115 x 2.5	22.2	25
45344A	125 x 2.5	22.2	25
45261A	180 x 3.0	22.2	25
45254A	230 x 3.0	22.2	25

### 2 CUTTING DISCS FOR METAL

- ОТРЕЗНЫЕ ДИСКИ ДЛЯ РЕЗКИ МЕТАЛЛА KRONENFLEX
- TRENNSCHEIBE FÜR METALLE



- CONVEX DISCS
- A24 EXTRA – all-purpose discs to be used in any metal machining sector
- Possible replacements: 45454A - KL188461  
45458A - KL188463  
45459A - KL189000  
45461A - KL189002

Code	Size (mm)	Hole (mm)	☐
45454A	115 x 2.5	22.2	25
45456A	125 x 2.5	22.2	25
45459A	180 x 3.0	22.2	25
45461A	230 x 3.0	22.2	25

### 3 CUTTING DISCS FOR METAL

- ОТРЕЗНЫЕ ДИСКИ ДЛЯ РЕЗКИ МЕТАЛЛА KRONENFLEX
- TRENNSCHEIBE FÜR METALLE



- CONVEX DISCS
- A24 EXTRA – all-purpose discs to be used in any metal machining sector
- Possible replacements: 45441A - KL13466  
45450A - KL13738  
45443A - KL13470  
45445A - KL13478

Code	Size (mm)	Hole (mm)	☐
45441A	115 x 2.5	22.2	25
45450A	125 x 2.5	22.2	25
45443A	180 x 3.0	22.2	25
45445A	230 x 3.0	22.2	25

### 4 CUTTING DISCS FOR METAL

- ОТРЕЗНЫЕ ДИСКИ ДЛЯ РЕЗКИ МЕТАЛЛА KRONENFLEX
- TRENNSCHEIBE FÜR METALLE



- FLAT DISCS • Type A 24 R SUPRA – high-performance discs for steel cutting

Code	Size (mm)	Hole (mm)	☐
KL6807	300 x 3.0	22.2	10

### 5 UNIVERSAL CUTTING DISCS FOR METAL

- УНИВЕРСАЛЬНЫЕ ОТРЕЗНЫЕ ДИСКИ ДЛЯ МЕТАЛЛА
- TRENN- UND SCHLEIFSCHEIBE FÜR METALLE



- CONVEX DISCS
- Type A 46 VZ SPECIAL – Ultrathin discs for efficient cutting and safe grinding with a single tool, ensuring excellent work parameters

Code	Size (mm)	Hole (mm)	☐
45471	115 x 2.0	22.2	25
45472	125 x 2.0	22.2	25

### 6 DEPRESSED CENTRE GRINDING DISCS FOR METAL

- ШЛИФОВАЛЬНЫЕ ДИСКИ ДЛЯ МЕТАЛЛА KRONENFLEX
- SCHLEIFSCHEIBE FÜR STAHL



- CONVEX DISCS
- Type A 24 R/36 SPECIAL – discs for grinding stainless and acid-proof steel, with high material removal efficiency

Code	Size (mm)	Hole (mm)	☐
45005A	115 x 6.0	22.2	10
45027A	125 x 6.0	22.2	10
45002A	180 x 6.0	22.2	10

### 7 DEPRESSED CENTRE GRINDING DISCS FOR METAL

- ШЛИФОВАЛЬНЫЕ ДИСКИ ДЛЯ МЕТАЛЛА KRONENFLEX
- SCHLEIFSCHEIBE FÜR STAHL



- CONVEX DISCS
- Type A 24 N SUPRA – discs for grinding stainless and acid-proof steel

Code	Size (mm)	Hole (mm)	☐
45072	125 x 6.0	22.2	10
45075A	230 x 6.0	22.2	10

### 8 DEPRESSED CENTRE GRINDING DISCS FOR METAL

- ШЛИФОВАЛЬНЫЕ ДИСКИ ДЛЯ МЕТАЛЛА KRONENFLEX
- SCHLEIFSCHEIBE FÜR STAHL



- CONVEX DISCS
- Type A 24 R SUPRA – discs for grinding steel
- Possible replacement: 45433A - KL13401

Code	Size (mm)	Hole (mm)	☐
45433A	115 x 6.0	22.2	10
KL13402	125 x 6.0	22.2	10
45076A	180 x 6.0	22.2	10
45079	230 x 8.0	22.2	10

### 1 DEPRESSED CENTRE GRINDING DISCS FOR METAL

- ШЛИФОВАЛЬНЫЕ ДИСКИ ДЛЯ МЕТАЛЛА KRONENFLEX
- SCHLEIFSCHEIBE FÜR STAHL



- CONVEX DISCS
- Type A 46 SUPRA – soft standard disc for grinding aluminium and other non-ferrous metals

Code	Size (mm)	Hole (mm)	
45890	115 x 6.0	22.2	10

### 2 DEPRESSED CENTRE GRINDING DISCS FOR METAL

- ШЛИФОВАЛЬНЫЕ ДИСКИ ДЛЯ МЕТАЛЛА KRONENFLEX
- SCHLEIFSCHEIBE FÜR STAHL



- CONVEX DISCS
- Type A 24 EXTRA – all-purpose discs to be used in any metal machining sector
- Possible replacements: 45462A - KL188465  
45458A - KL188466  
45435A - KL13444

Code	Size (mm)	Hole (mm)	
KL13446	180 x 8.0	22.2	10
KL13447	115 x 6.0	22.2	10
45435A	180 x 6.0	22.2	10
45458A	125 x 6.0	22.2	10
45652A	115 x 6.0	22.2	10

### 3 CUTTING DISCS FOR STONE

- ОТРЕЗНЫЕ ДИСКИ ДЛЯ РЕЗКИ КАМНЯ KRONENFLEX
- TRENNSCHEIBEN FÜR STEIN



- CONVEX DISCS
- Type C 24 R SUPRA – high-performance discs for machining mineral materials
- Possible replacements: 45444A - KL13475

Code	Size (mm)	Hole (mm)	
45442A	180 x 3.0	22.2	25
45444A	230 x 3.0	22.2	25

### 4 CUTTING DISCS FOR STONE

- ОТРЕЗНЫЕ ДИСКИ ДЛЯ РЕЗКИ КАМНЯ KRONENFLEX
- TRENNSCHEIBEN FÜR STEIN



- CONVEX DISCS
- Type C 24 EXTRA – economic discs for machining mineral materials
- Possible replacements: 45455A - KL188462  
45457A - KL188464

Code	Size (mm)	Hole (mm)	
45455A	115 x 2.5	22.2	25
45457A	125 x 2.5	22.2	25

### 5 CUTTING DISCS FOR STONE

- ОТРЕЗНЫЕ ДИСКИ ДЛЯ РЕЗКИ КАМНЯ KRONENFLEX
- TRENNSCHEIBEN FÜR STEIN



- FLAT DISCS
- Type C 24 R SUPRA – high-performance discs for machining mineral materials

Code	Size (mm)	Hole (mm)	
KL13465	115 x 2.5	22.2	25
45429A	125 x 2.5	22.2	25
45339A	180 x 3.0	22.2	25
KL13461	230 x 3.0	22.2	25

### 6 CUTTING DISCS FOR STONE

- ОТРЕЗНЫЕ ДИСКИ ДЛЯ РЕЗКИ КАМНЯ KRONENFLEX
- TRENNSCHEIBEN FÜR STEIN



- FLAT DISCS
- Type C 24 EXTRA – economic discs for machining mineral materials

Code	Size (mm)	Hole (mm)	
KL13489	180 x 3.0	22.2	25
KL13491	230 x 3.0	22.2	25



### 7 FLAP WHEELS

- ТОРЦЕВЫЕ ШЛИФОВАЛЬНЫЕ ЛЕПЕСТКОВЫЕ ДИСКИ С ХВОСТОВИКОМ Ø 6 мм - SCHLEIFMORP



- KM 613 • Flap discs made from abrasive cloth with aluminium oxide grain applied radially on the pin Ø 6 mm • Application: general, cleaning, finish polishing of components with complex shapes for handheld machines

Code	Dia. x width (mm)	Granulation	
45602X	30 x 15	40	10
45603X	30 x 15	60	10
45399	40 x 20	40	10
45400	40 x 20	60	10
45401	40 x 20	80	10
45402	40 x 20	100	10
45403	40 x 20	120	10
45404	60 x 30	40	10
45405	60 x 30	60	10
45406	60 x 30	80	10
45407	60 x 30	100	10
45408	60 x 30	120	10
45509X	60 x 30	150	10
45409	80 x 30	40	10
45410	80 x 30	60	10
45411	80 x 30	80	10
45412	80 x 30	100	10
45413	80 x 30	120	10

### 8 FLAP DISCS OF ALUMINIUM OXIDE

- ШЛИФОВАЛЬНЫЕ ЛЕПЕСТКОВЫЕ ДИСКИ
- SCHLEIFMOPTELLER



- SMT 324 • Leaf grinding discs for multi-purpose metal machining, primarily edge grinding • Good value for money • Convex • Hole dia. 22.2 mm

Code	Diameter (mm)	Granulation	
KL321509	115	40	10
KL321511	115	60	10
KL321513	115	80	10

### 1 FLAP DISCS OF ALUMINIUM OXIDE

- ШЛИФОВАЛЬНЫЕ ЛЕПЕСТКОВЫЕ ДИСКИ
- SCHLEIFMORTELLER



- Type SMT 325 • Flap discs made from abrasive linen with zirconium oxide grain, applied evenly on the plastic body reinforced with glass fibre
- Straight • Application: grinding surfaces, metal, steel, steel sheets, brass, bronze • Hole dia. 22.2 mm • Convex

Code	Diameter (mm)	Granulation	
KL321653	115	40	10
KL321655	115	60	10
KL321657	115	80	10

### 2 FLAP DISCS OF ALUMINIUM OXIDE

- ШЛИФОВАЛЬНЫЕ ЛЕПЕСТКОВЫЕ ДИСКИ
- SCHLEIFMORTELLER



- Type SMT 624 • Application: for machining steel and highgrade stainless steel • For edge grinding • Flap discs (fin plates) with aggressive zirconium oxide • Convex • Hole dia. 22.2 mm

Code	Diameter (mm)	Granulation	
KL322771	125	36	10
KL322772	125	40	10
KL322774	125	60	10
KL322775	125	80	10
KL322776	125	120	10

### 3 FLAP DISCS OF ALUMINIUM OXIDE

- ШЛИФОВАЛЬНЫЕ ЛЕПЕСТКОВЫЕ ДИСКИ • SCHLEIFMORTELLER



### 4 FLAP DISCS OF ALUMINIUM OXIDE

- ШЛИФОВАЛЬНЫЕ ЛЕПЕСТКОВЫЕ ДИСКИ
- SCHLEIFMORTELLER



- SMT 926 • Leaf grinding discs for multi-purpose professional application • Perfect durability and high performance of grinding
- Convex • Hole dia. 22.2 mm

Code	Diameter (mm)	Granulation	
KL321704	125	40	10
KL321707	125	60	10
KL321709	125	80	10

### 5 FLAP DISCS OF ALUMINIUM OXIDE

- ШЛИФОВАЛЬНЫЕ ЛЕПЕСТКОВЫЕ ДИСКИ
- SCHLEIFMORTELLER



- Type SMT 314 • Flap discs made from abrasive linen with aluminium oxide grain, applied evenly on the glass fibre body • Convex 12°
- Application: perfect for machining edges, welding seams on stainless steel, steel sheets, aluminium, brass, bronze, wood, plastic, paints and varnishes
- Hole dia. 22.2 mm

Code	Diameter (mm)	Granulation	
KL322809	115	40	10
KL322811	115	60	10
KL322812	115	80	10
KL322813	115	120	10
KL322815	125	40	10
KL322817	125	60	10
KL322818	125	80	10
KL322819	125	120	10
KL322821	180	40	10
KL322822	180	60	10
KL322823	180	80	10

- Type SMT 626 • Application: for machining steel and highgrade stainless steel • For grinding edges and seams, also for grinding frontal surfaces of objects and large surfaces • Flap discs (fin plates) with aggressive zirconium oxide • Convex • Hole dia. 22.2 mm

Code	Diameter (mm)	Granulation	
KL321689	115	40	10
KL321694	115	60	10
KL321697	115	80	10
KL321690	125	40	10
KL321695	125	60	10
KL321698	125	80	10

### 6 SELF ADHESIVE PAPER DISCS

- КРУЖКИ ШЛИФОВАЛЬНЫЕ НА САМОЗАЦЕПЛЯЕМОЙ ОСНОВЕ
- SCHLEIFSCHIBEN AUS PAPIER, HAFTEND



- Type PS 22 K - with dust ports
- Base - heavy paper, E Type • Grit - aluminium oxide, semi-continuous • Binder - artificial resin • Application: for grinding metal and wood, including hardwood, plywood, MDF, wooden floors • Sold in packs of 1 pc.

Code	Diameter (mm)	Granulation	
45115	115	40	50
45116	115	60	50
45117	115	80	50
45118	115	100	50
45119	115	120	50

### 7 SELF ADHESIVE PAPER DISCS

- КРУЖКИ ШЛИФОВАЛЬНЫЕ НА САМОЗАЦЕПЛЯЕМОЙ ОСНОВЕ
- SCHLEIFSCHIBEN AUS PAPIER, HAFTEND



- Type PS 22 K - with dust ports
- Base - heavy paper, E Type • Grit - aluminium oxide, semi-continuous • Binder - artificial resin • Application: for grinding metal and wood, including hardwood, plywood, MDF, wooden floors
- Sold in packs of 5 pcs.

Code	Diameter (mm)	Granulation	
45293	125	40	5
45294	125	60	5
45295	125	80	5
45297	125	120	5

**1 SELF ADHESIVE PAPER DISCS**

- КРУЖКИ ШЛИФОВАЛЬНЫЕ НА САМОЗАЦЕПЛЯЕМОЙ ОСНОВЕ
- SCHLEIFSCHIBEN AUS PAPIER, HAFTEND



- Type PS 22 K - without dust ports
- Base - heavy paper; E Type • Grit - aluminium oxide, semi-continuous • Binder - artificial resin • Application: for grinding metal and wood, including hardwood, plywood, MDF, wooden floors • Sold in sets of 5 pc

Code	Diameter (mm)	Granulation	
45536	125	40	10
45537	125	60	10
45538	125	80	10
45540	125	120	10

**2 SELF ADHESIVE PAPER DISCS**

- КРУЖКИ ШЛИФОВАЛЬНЫЕ НА САМОЗАЦЕПЛЯЕМОЙ ОСНОВЕ
- SCHLEIFSCHIBEN AUS PAPIER, HAFTEND



- Type PL 28 CK - without dust ports
- Base - lightweight paper C • Grit - aluminium oxide, continuous • Binder - glue - resin
- Application: all-purpose, for grinding wood, metal, varnishes and plastic • Sold in packs of 1 pc.

Code	Diameter (mm)	Granulation	
45782C	125	36	50
45740C	125	40	50
45741C	125	60	50
45742C	125	80	50
45743C	125	100	50
45365C	125	120	50
45744C	125	150	50
45745C	125	180	50
45746C	125	220	50
45747C	125	240	50

**3 SELF ADHESIVE PAPER DISCS**

- КРУЖКИ ШЛИФОВАЛЬНЫЕ НА САМОЗАЦЕПЛЯЕМОЙ ОСНОВЕ
- SCHLEIFSCHIBEN AUS PAPIER, HAFTEND



- Type PS 21FK
- Base - paper • Grit - full zirconium oxide
- Binder - artificial resin • Recommended for aggressive grinding due to the self-sharpening zirconium alumina • High durability • Sold by 1 pc.

Code	Diameter (mm)	Granulation	
45791C	125	40	50
45792C	125	60	50
45793C	125	80	50
45794C	125	100	50
45795C	125	120	50
45796C	125	150	50
KL237786	125	320	50
KL237787	125	400	50

**4 SELF ADHESIVE PAPER DISCS**

- КРУЖКИ ШЛИФОВАЛЬНЫЕ НА САМОЗАЦЕПЛЯЕМОЙ ОСНОВЕ
- SCHLEIFSCHIBEN AUS PAPIER, HAFTEND



- Type PS 33 CK - with dust ports
- Base - paper C • Grit - aluminium oxide, semi-continuous • Binder - artificial resin
- Application: for machining paints, varnishes and fillers, especially for car repairs • Sold by 1 pc.

Code	Diameter (mm)	Granulation	
45535F	150	60	100
45535D	150	80	100
45869E	150	120	100
45543F	150	150	100
45546F	150	180	100
KL294609	225	100	50
KL292437	225	120	50
KL293646	225	150	50
KL293647	225	180	50
KL293648	225	220	50
<b>holes scheme GLS52</b>			
KL302042	225	40	100
KL302043	225	60	100
KL302044	225	80	100
KL302045	225	100	100
KL302046	225	120	100
KL302049	225	220	100

**5 SELF ADHESIVE PAPER DISCS**

- КРУЖКИ ШЛИФОВАЛЬНЫЕ НА САМОЗАЦЕПЛЯЕМОЙ ОСНОВЕ
- SCHLEIFSCHIBEN AUS PAPIER, HAFTEND

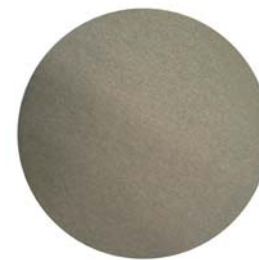

- Type PS 33
- Base - paper C (45361-45364), B (45365-45366) • Grit - aluminium oxide, semicontinuous
- Binder - artificial resin • High-quality sanding papers, especially for machining paints, varnishes and fillers • Can be used for grinders THZ600 and THZ800 • Sold by 1 pc..

Code	Diameter (mm)	Granulation	
45361	225	60	50
45362	225	80	50
45363	225	100	50
45364	225	120	50
45365	225	150	50
45366	225	180	50

**6 SELF ADHESIVE FIBRE DISCS**

- ФИБРОВЫЕ ШЛИФОВАЛЬНЫЕ ДИСКИ НА САМОЗАЦЕПЛЯЕМОЙ ОСНОВЕ • SCHLEIFSCHIBEN AUS FASERN



- Type CS 561 FIBRA
- Base - fibre • Grit - full aluminium oxide
- Binder - artificial resin • Application: for machining metal, removing corrosion, lagging, seam grinding • For angle grinders with a displacement disc (see product no. 27023, 27024, 27026) • Sold in packs of 1 pc.

Code	Diameter (mm)	Granulation	
45344X	115	16	25
45268A	115	24	25
45269A	115	36	25
45351A	115	40	25
45271A	115	60	25
45272A	115	80	25
45342A	115	100	25
45267A	115	120	25
45352A	125	16	25
45274X	125	24	25
45275A	125	36	25
45359A	125	40	25
45277A	125	60	25
45278A	125	80	25
45360A	125	100	25
45273A	125	120	25
45362A	180	16	25
45280A	180	24	25
45281A	180	36	25
45369A	180	40	25
45283A	180	60	25
45284A	180	80	25
45490A	180	100	25
45279A	180	120	25

### 1 SANDING SHEETS DELTA

• ДЕЛЬТОВИДНЫЕ ШЛИФОВАЛЬНЫЕ ЛИСТЫ НА САМОЗАЦЕПЛЯЕМОЙ ОСНОВЕ • SCHLEIFBLÄTTER TYPE „DELTA“, HAFTEND

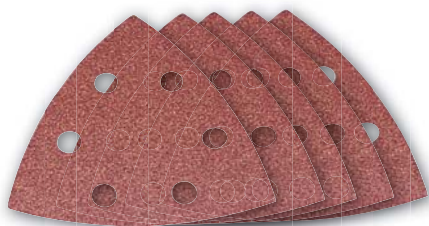

- Type PS 22 K - DELTA with dust ports • Base - E paper reinforced with a technical textile
- Grit - aluminium oxide, semicontinuous
- Binder - artificial resin • Application: for grinding wood, paints, varnishes, rubber, and especially wooden floors and parquet • Sold in sets of 5 pcs.

Code	Size (mm)	Granulation	
45602	94 x 94	40	10
45603	94 x 94	60	10
45604	94 x 94	80	10
45606	94 x 94	120	10

### 2 SANDING SHEETS

• ШЛИФОВАЛЬНЫЕ ЛИСТЫ • SCHLEIFPAPIER IN BOGENFORM



- Type PS 30 D
- Base - lightweight paper D • Grit - semi-continuous aluminium oxide • Binder - artificial resin • Application: for deciduous and coniferous wood and gypsum • Sold by 1 pc..

Code	Size (mm)	Granulation	
45555	230 x 280	60	50
45557	230 x 280	100	50
45558	230 x 280	120	50

### 3 WET AND DRY PAPER SHEETS

• ШЛИФОВАЛЬНЫЕ ВОДОСТОЙКИЕ ЛИСТЫ • NASS UND TROCKEN SCHLEIFBLÄTTER

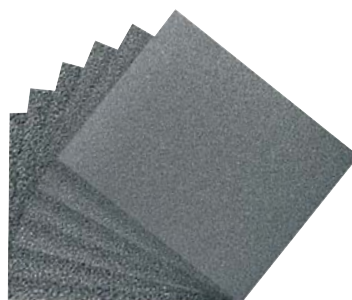

- Type PS 8 A
- Base - latex covered paper A • Grit - full silicon carbide • Application: for metal and plastic surfaces, paints, varnishes, glass etc.
- In particular, wet machine grinding of sheet metal after priming, grinding paints, varnishes, plastics, both dry and wet, preparation of metallographic compositions
- Sold by 1 pc.

Code	Size (mm)	Granulation	
45015Z	280 x 230	60	50
45016	280 x 230	80	50
45017	280 x 230	100	50
45018	280 x 230	120	50
45019	280 x 230	150	50
45020	280 x 230	180	50
45021Z	280 x 230	220	50
45022	280 x 230	240	50
45023Z	280 x 230	280	50
45023	280 x 230	320	50
45025	280 x 230	360	50
45026	280 x 230	400	50
45027	280 x 230	500	50
45028	280 x 230	600	50
45029	280 x 230	800	50
45030	280 x 230	1000	50
45031	280 x 230	1200	50
45032Z	280 x 230	1500	50
45033Z	280 x 230	2000	50
45034Z	280 x 230	2500	50

### 4 CLOTH BACKED SANDING SHEETS

• ШЛИФОВАЛЬНЫЕ ЛИСТЫ • SCHLEIFBLÄTTER



- Type KL 375 J • Base - cloth J • Grit - continuous aluminium oxide • Binder - glue - resin • Application: standard sanding sheet, for manual processing of metal, very elastic
- Sold by 1 pc.

Code	Size (mm)	Granulation	
45314B	230 x 280	40	50
45315B	230 x 280	60	50
45316B	230 x 280	80	50
45317B	230 x 280	100	50
45318B	230 x 280	120	50
45319B	230 x 280	150	50
45320B	230 x 280	180	50
45712C	230 x 280	220	50

### 5 SANDING SHEETS

• ШЛИФОВАЛЬНЫЕ ЛИСТЫ • SCHLEIFPAPIER IN BOGENFORM



- Type PL 28 C
- Base - paper C • Grit - ordinary aluminium oxide, continuous • Binder - glue - resin
- Application: all-purpose, for grinding wood, metal, varnishes and plastic • Sold by 1 pc..

Code	Size (mm)	Granulation	
45800B	230 x 280	40	50
45801B	230 x 280	60	50
45763B	230 x 280	80	50
45354C	230 x 280	100	50
45764B	230 x 280	120	50
45355C	230 x 280	150	50
45356C	230 x 280	180	50
45748C	230 x 280	220	50
45982D	230 x 280	240	50

### 6 ABRASIVE ROLLS

• ШЛИФОВАЛЬНЫЕ ЛЕНТЫ В РУЛОНАХ • SCHLEIFPAPIER IN ROLLENFORM



- PS 30 D • Base - paper D • Grit - semicontinuous aluminium oxide • Binder - artificial resin • Application: for wood, paints, varnishes and filler • Sold in rolls of 5 m

Code	Size Width x Length	Granulation	
45431	115 mm x 5 m	40	10 rolls
45432	115 mm x 5 m	60	10 rolls
45433	115 mm x 5 m	80	10 rolls
45434	115 mm x 5 m	100	10 rolls
45435	115 mm x 5 m	120	10 rolls

**1 ABRASIVE ROLLS**

• ШЛИФОВАЛЬНЫЕ ЛЕНТЫ В РУЛОНАХ • SCHLEIFPAPIER IN ROLLENFORM



- PS 30 D
- Base - paper D • Grit - semi-continuous aluminium oxide • Binder - artificial resin
- Application: for grinding wood, paints, varnishes and filler • Sold based on roll length

Code	Width (mm)	Granulation	Length (m)
45702CM	93	40	30
45923BM	93	60	50
45924BM	93	80	50
45925BM	93	100	50
45926BM	93	120	50
45927BM	93	150	50
45975CM	93	180	50
45976CM	93	240	50
45704CM	115	40	30
45930BM	115	60	50
45931BM	115	80	50
45503BM	115	100	50
45932BM	115	120	50
45504BM	115	150	50
45505BM	115	180	50
45506BM	115	240	50

**2 CLOTH BACKED ABRASIVE ROLLS**

• ШЛИФОВАЛЬНЫЕ ТКАНЕВЫЕ ЛЕНТЫ В РУЛОНАХ • SCHLEIFPAPIER IN BOGENFORM



- Type KL 381 J
- Base - lightweight cloth J - brown • Grit - ordinary continuous aluminium oxide
- Binder - glue - resin • Application: standard product for machine and manual grinding of metal and wood • Sold based on roll length

Code	Width (mm)	Granulation	Length (m)
45348	150	40	30
45351	150	60	50
45353	150	80	50
45354	150	100	50
45355	150	120	50
45282CM	200	24	30
45360CM	200	36	30
45263CM	200	40	30
45999BM	200	60	50
45000CM	200	80	50
45001CM	200	100	50
45002CM	200	120	50
45003CM	200	150	50
45004CM	200	180	50
45005CM	200	220	50
45006CM	200	240	50

**3 ABRASIVE BELTS**

• ШЛИФОВАЛЬНЫЕ БЕСКОНЕЧНЫЕ ТКАНЕВЫЕ ЛЕНТЫ • SCHLEIFBAND



- LS 309 XH
- Base - heavy flexible textile X • Grit - ordinary continuous aluminium oxide • Binder - artificial resin • Application: for grinding cast iron, steel, nonferrous metals, plastic, paints, varnishes and wood using handheld power tools • Sold in sets of 3 pcs.

Code	Size (mm)	Granulation	
45541	75 x 457	40	6
45542	75 x 457	60	6
45543	75 x 457	80	6
45544	75 x 457	100	6
45545	75 x 457	120	6
45335	75 x 533	40	6
45336	75 x 533	60	6
45337	75 x 533	80	6
45338	75 x 533	100	6
45339	75 x 533	120	6
45340	100 x 610	40	6
45341	100 x 610	60	6
45342	100 x 610	80	6
45343	100 x 610	100	6
45344	100 x 610	120	6

**4 ABRASIVE BELTS**

• ШЛИФОВАЛЬНЫЕ БЕСКОНЕЧНЫЕ ТКАНЕВЫЕ ЛЕНТЫ • SCHLEIFBAND



- LS 307 X
- Base - heavy flexible textile X • Grit - ordinary continuous aluminium oxide • Binder - artificial resin • Application: for grinding cast iron, steel, nonferrous metals, plastic, paints, varnishes and wood using handheld power tools • Sold in sets of 1 pc.

Code	Size (mm)	Granulation	
45128B	75 x 457	40	10
45310B	75 x 457	60	10
45131B	75 x 457	80	10
45247B	75 x 457	100	10
45248B	75 x 457	120	10
45096B	75 x 533	40	10
45097B	75 x 533	60	10
45098B	75 x 533	80	10
45099B	75 x 533	100	10
45100B	75 x 533	120	10
45646	75 x 533	150	10
45043	75 x 533	180	10
45129B	100 x 610	40	10
45130B	100 x 610	60	10
45133B	100 x 610	80	10
45132B	100 x 610	100	10
45311B	100 x 610	120	10

**5 GRINDING FELT SHEET**

• ЛИСТОВОЕ ШЛИФОВАЛЬНОЕ ВОЛОКНО • FILZ-SCHLEIFPLATTE



- For deburring, cleaning and surface treatment • Application: for grinding paints, varnishes and stainless steel.

Code	Width x Length (mm)	Granulation	
45345	152x229	180	



# EXPRESS

flame resistant sheets  
gas cartridges  
power torches

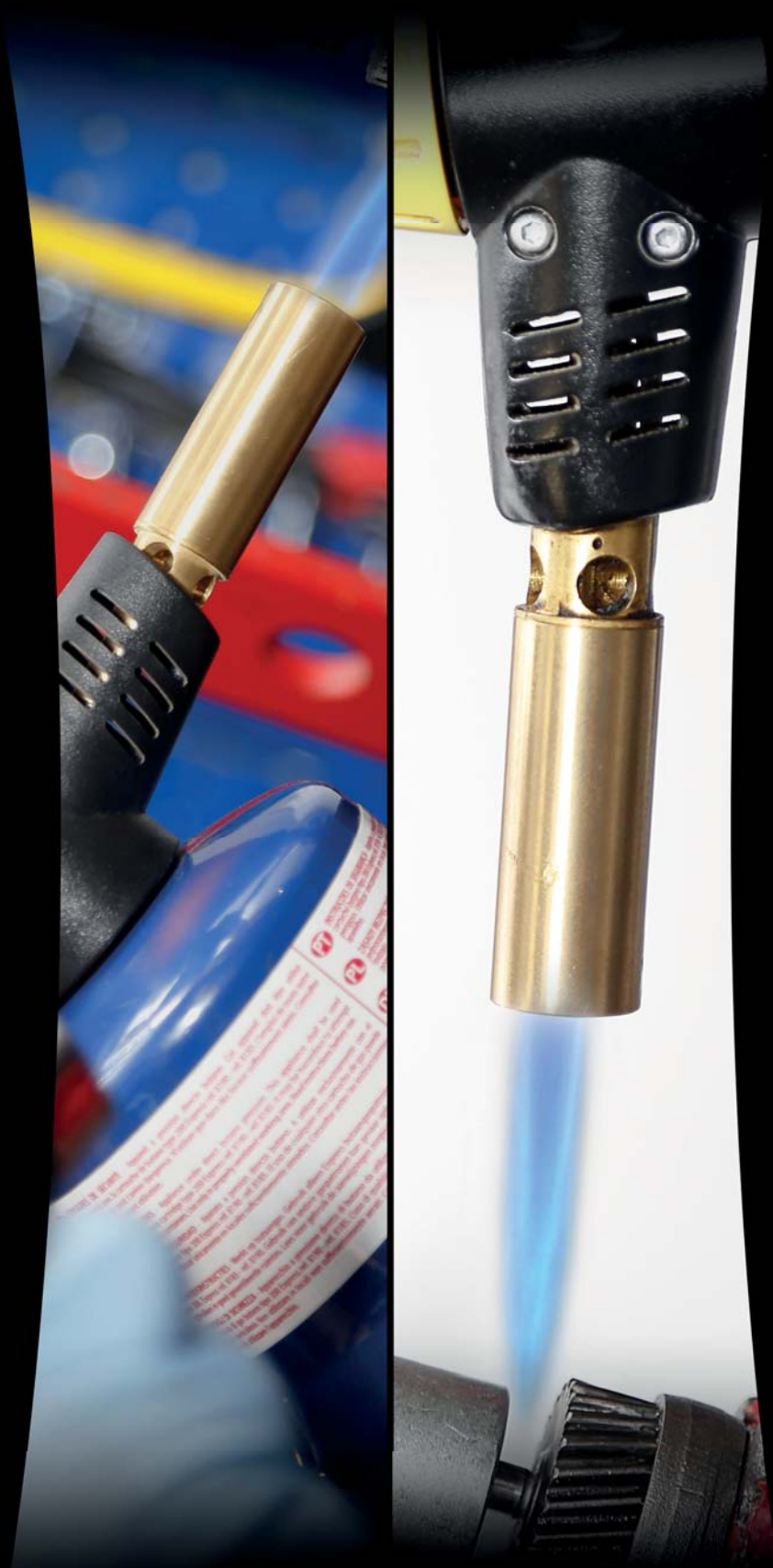



**1 POWER TORCH**

• ПАЯЛЬНАЯ ЛАМПА • LÖTLAMPE

- Flame temp. 1850°C
- Gas consumption 110g/h
- Rapid flame stabilization (1.5 min)
- Perfect for heating, plumbing, airconditioning systems
- Easy to use, ergonomic, stable base
- Replaceable, high-performance disposable LPG container (E8191- 190g)
- Metal body





Code	Temperature of flame		
<b>E8700</b>	1850°C	x	6

**2 AUTO POWER TORCH**

• ПАЯЛЬНАЯ ЛАМПА • LÖTLAMPE PIEZO

- Flame temp. 1850°C
- Gas consumption 110g/h
- Convenient piezoelectric ignition
- Rapid flame stabilization (1.5 min)
- Perfect for heating, plumbing, airconditioning systems
- Easy to use, ergonomic, stable base
- Replaceable, high-performance disposable LPG container (E8191- 190g)
- Metal body





Code	Temperature of flame		
<b>E8800</b>	1850°C	x	6

**3 AUTO POWER TORCH**

• ПАЯЛЬНАЯ ЛАМПА • LÖTLAMPE PIEZO

- Flame temp. 1850°C
- Gas consumption 110g/h
- Convenient piezoelectric ignition
- Possible instant turn with flame stabilization after 15 sec.
- Perfect for heating, plumbing, airconditioning systems
- Easy to use, ergonomic, stable base
- Replaceable, high-performance disposable LPG container (E8191- 190g)
- Metal body



Code	Temperature of flame		
<b>E8900</b>	1850°C	x	6

### 1 POWER TORCH

• ПАЯЛЬНАЯ ЛАМПА • LÖTLAMPE EXPRESS, KLASSISCH MIT DÜSE FÜR EINE KONZENTRIERTE FLAMME

- Flame temp. 1850°C with gas container E5550
- Perfect for heating, plumbing, airconditioning systems
- The set with a gas container E5550 - 340g work time 2 - 10h depending on the load
- Container with an European valve enables to mount/dismount without any gas loss
- After 2 minutes of heating can be used in any position



Code	Temperature of flame		
E5110	1850°C	x	2

### 2 PLUMBER POWER TORCH

• ПАЯЛЬНАЯ ЛАМПА • LÖTLAMPE EXPRESS FÜR HYDRAULIKER MIT 2 DÜSEN

- Flame temp. 2015°C with gas container E2015
- Perfect for heating, plumbing, air-conditioning systems
- The set includes gas container E2015 - 326g
- Work time 2-10h depending on the load
- Container with an European valve enables to mount/dismount without any gas loss
- After 2 minutes of heating can be used in any position



Code	Temperature of flame		
E5250	2015°C	x	2

### 3 POWER TORCH

• ПАЯЛЬНАЯ ЛАМПА • MULTIFUNKTIONSLÖTLAMPE EXPRESS MIT 3 DÜSEN

- Flame temp. 1850°C with gas container E5550
- The set includes the following nozzles: enveloping, concentrated flame and flat flame
- Perfect for heating, plumbing, airconditioning systems
- The set includes gas container E5550 - 340g
- Work time 2-10h depending on the load
- Container with an European valve enables to mount/dismount without any gas loss
- After 2 minutes of heating can be used in any position



Code	Temperature of flame		
E5310	1850°C	x	2

### 4 POWER TORCH

• ПАЯЛЬНАЯ ЛАМПА • BUTANLÖTBRENNER MIT ZUBEHÖR



- Flame temp. 1850°C
- The set includes nozzles: Cercoflam for soldering copper tubes Ø 24mm, for heat-removal of varnish coats, supply hose 1.5m
- Gas consumption 312g/h
- Burner output 4.3 kW

Code	Temperature of flame		
E5200	1850°C	x	4

### 5 LAME RESISTANT SHEET

• ОГНЕУПОРНЫЙ МАТ • FEUERBESTÄNDIGE MATTE



- For protecting the soldering/brazing site
- Does not contain asbestos, made from glass fibre

Code	Size (mm)		
E5459	200 x 250	x	50

### 1 POWER TORCH

• ПАЯЛЬНАЯ ЛАМПА • LÖTLAMPE PIEZO



- Flame temp. depending on the container used: 1850°C for E5550 2015°C for E2015 • Application: Plumbing systems, soldering and brazing, heatremoval, defrosting, corrosion removal • Continuous operation 100 min. • Container with an European valve enables to mount/dismount without any gas loss • After 10-15 sec. of heating can be used in any position

Code	Temperature of flame		
E3420	1850°C	x	2

### 3 PROFESSIONAL AUTO POWER TORCH

• ПАЯЛЬНАЯ ЛАМПА • PROFESSIONELLER BRENNER VULCAN EXPRESS



- Flame temp. 2400°C • Nozzle for soldering copper tubes with dia. up to 22 mm • Plumbing, heating and air-conditioning systems
- Spinning Turbo flame - ensures even heat distribution round the perimeter of the soldered/brazed tubes • Piezoelectric ignition
- Double flame work - interrupted and continuous • Instant work in any position • „Hands free" support - to rest the burner on the ground when the work requires two hands • Gas container 399g MAP/Pro (cat. no. E2400) • Ergonomic burner made from friendly and safe materials

Code	Temperature of flame		
E4700	2400°C	x	1

### 2 POWER TORCH

• ПАЯЛЬНАЯ ЛАМПА • LÖTLAMPE PIEZO



- Flame temp. depending on the container used: 1850°C for E5550; 2015°C for E2015 • Application: Plumbing systems, soldering and brazing, heat-removal, defrosting, corrosion removal • Continuous operation 80 min.
- Container with an European valve enables to mount/dismount without any gas loss • After 10-15 sec. of heating can be used in any position

Code	Temperature of flame		
E3430	2015°C	x	2

### 4 HOT AIR GUN

• АВТОМАТИЧЕСКИЙ ПИСТОЛЕТ ГОРЯЧЕГО ВОЗДУХА • AUTOMATISCHE HEISSLUFTPISTOLE



- Work temperature range: 400°C - 750°C • Automatic ignition
- Work even at - 8°C • For heating galvanised surfaces without damaging them • Processing coats and PVC pipes • Shrinking plastic and selfadhesive strips • Facilitates installation of adhesive floorings • Welding and repairing PCV covers • Drying gypsumboard connections • Drying or heat-removing paint and varnish coats • Defrosting plumbing systems and locks • For loosening corroded bolts and nuts • With E4440 container - 60g

Code	Range of temperatures		
E4500V	400°C - 750°C	x	1

**1 GAS CARTRIDGE**

• КАРТРИДЖ С ГАЗОМ • GASPPATRONE



• For burners E4700, E4720

Code	Volume (g)	
E2400	399	12

**2 BUTANE-PROPANE-PROPYLENE CARTRIDGE**

• ГАЗОВЫЙ КАРТРИДЖ • PROPAN-BUTAN-PROPYLEN  
GASPPATRONE



• For E5110, E5250, E5310, E3420, E3430

Code	Volume (g)	
E2015	326	12

**3 BUTANE-PROPANE-PROPYLENE CARTRIDGE**

• ГАЗОВЫЙ КАРТРИДЖ • PROPAN - BUTAN - PROPYLEN  
GASPPATRONE



• For E5110, E5250, E5310, E3420, E3430, E4500  
• Can be operated in any position

Code	Volume (g)	
E4440	60	12

**4 BUTANE-PROPANE CARTRIDGE**

• ГАЗОВЫЙ КАРТРИДЖ • PROPAN - BUTAN GASPPATRONE



• For E5110, E5250, E5310, E3420, E3430

Code	Volume (g)	
E5550	340	12

**5 BUTANE-PROPANE CARTRIDGE**

• ГАЗОВЫЙ КАРТРИДЖ • GASPPATRONE BUTAN - PROPAN MIT  
ABSICHERUNG "STOP GAS"



• Unique system preventing gas leak if the torch gets detached from the cartridge  
• For E8700, E8800, E8900

Code	Volume (g)	
E8191	190	36

# ACTION CAN

chemical products

cleaning agents

greases

oils

removers

rust converters

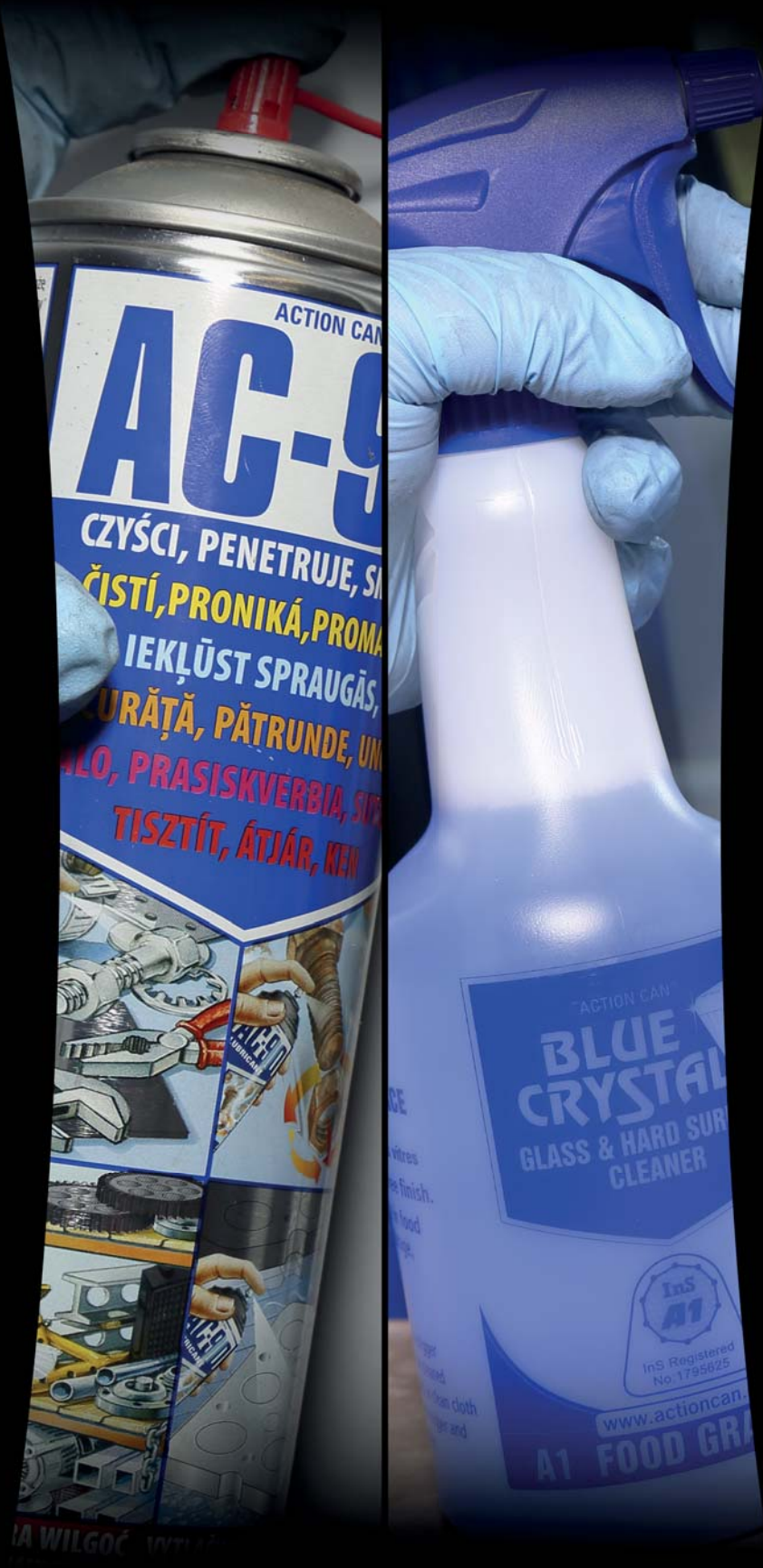

ACTION CAN  
**AC-9**

CZYŚCI, PENETRUJE, S  
ČISTÍ, PRONIKÁ, PROMA  
IEKLŪST SPRAUGĀS,  
URĀĶĀ, PĀTRUNDE, UN  
ALO, PRASISKVERBIA, S  
TISZTÍT, ÁTJÁR, KEN



ACTION CAN  
**BLUE CRYSTAL**  
GLASS & HARD SURF  
CLEANER

InS  
**A1**  
InS Registered  
No. 1795625

[www.actioncan.com](http://www.actioncan.com)

**A1 FOOD GRA**

IA WILGOĆ WY

**1 AC90 ANTICORROSION MAINTENANCE SPRAY**

• AC 90 УНИВЕРСАЛЬНЫЙ ПРЕПАРАТ - ТЫСЯЧА ОДИН СПОСОБ ПРИМЕНЕНИЯ • AC90 MULTIFUNKTIONSREINIGUNGS- UND KONSERVIERUNGSMITTEL

**ACTION CAN** 60 years of experience  
made in U.K. on the global aerosol market



**PENETRATES, LUBRICATES, REMOVES CORROSION, REMOVES MOISTURE**

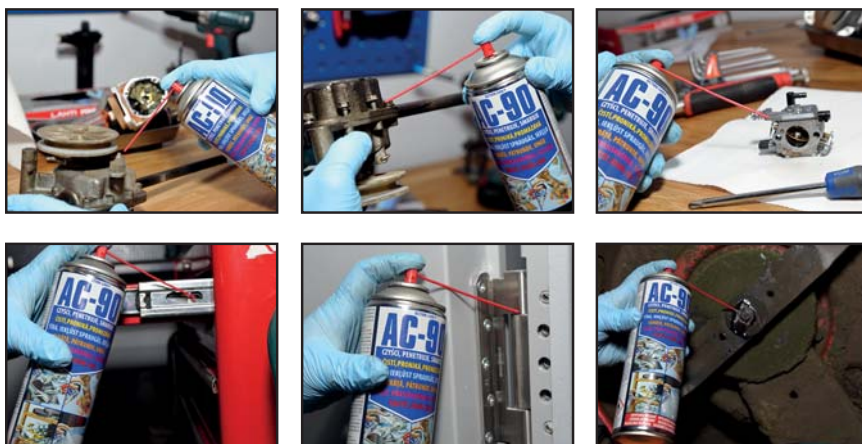

- Quickly releases corroded and baked-on components
- Cleans and protects devices against corrosion
- Removes any squeaks and creaks of hinges, locks, curtain rails and other mechanical devices
- Improves operation of ignition system exposed to water or moisture
- Penetrates under the moist layer, creating a protective barrier between water and metals
- Eliminates short circuits caused by water
- Recommended for electrical ignition
- Protects vehicle locks from moisture and freezing
- Removes dirt, dust, marks left by crayons and felt-tip markers, chewing gum and adhesives
- 1001 applications in industry, workshop, household

Code	Volume (ml)	
42358	500	15

**2 CS90 COPPER ANTI-SEIZE GREASE**

• CS90 ВЫСОКОТЕМПЕРАТУРНАЯ СМАЗКА НА БАЗЕ МЕДИ С ДОБАВКОЙ ГРАФИТА • CS90 CU-FETT HOCH-TEMP. 1200°C



- High-temperature solid grease
- Based on copper and graphite, waterresistant and lead-free
- Penetrates inside chains, ropes, locks and clamps, brakes and bearings
- Does not contain silicone or chlorides
- Up to 1200°C
- Offers anti-corrosion protection

Code	Weight (g)	
42340	500	12

**3 CT90 CUTTING & TAPING FLUID**

• CT90 ПРЕПАРАТ ДЛЯ ОБРАБОТКИ МЕТАЛЛА В СПРЕЕ  
• CT90 PRÄPARAT ZUR SPANBEARBEITUNG: METALLE



- Spray for cutting and drilling metals and stainless steels (except for non-ferrous metals)
- Facilitates cutting, threading, drilling also in mineral materials
- Significantly shortens the machining and expands life of tools
- Minimises the risk of tube wall damage when threading

Code	Volume (ml)	
42341	500	15

PROLINE

LAHTI PRO

MEGA

JUCO

OTHER BRANDS

ERDI

KLINGSPOR

EXPRESS

**ACTION CAN**

TRYTON

VULCAN





**1 TF90 FAST DRYING CLEANING SOLVENT**

- TF90 ПРОМЫШЛЕННЫЙ БЫСТРОСОХНУЩИЙ РАСТВОРИТЕЛЬ
- TF90 INDUSTRIE-LÖSUNGSMITTEL



- Fast-drying solvent. Removes dirt, e.g. oil, grease, tar, wax, coal • Can be used also for cleaning electrical components

Code	Volume (ml)	Icon
42342	500	15

**3 SL90 VISCOUS LUBRICATING OIL + P.T.F.E.**

- SL90 МИНЕРАЛЬНОЕ МАСЛО С ПТФЕ В СПРЕЕ
- SL90 MINERALÖL MIT P.T.F.E



- High-quality all-purpose mineral oil spray with P.T.F.E. • Perfect corrosion protection of any surface • Up to 250°C • Does not contain silicone

Code	Volume (ml)	Icon
42343	500	15

**5 CG90 GENERAL CLEAR GREASE + P.T.F.E.**

- CG90 МИНЕРАЛЬНАЯ ВОДОУДОПОРНАЯ СМАЗКА (ПРОЗРАЧНАЯ) С ПТФЕ - CG90 MINERALSCHMIERMITTEL REIN, MIT ZUSATZ VON P.T.F.E.



- Mineral grease with P.T.F.E., waterproof • All-purpose grease • Designed for work temperatures up to 250°C • Perfect for bearings, chains and springs

Code	Volume (ml)	Icon
42348	500	15

**2 RP90 RAPID PENETRATING & RELEASE FLUID**

- RP90 ПРЕОБРАЗОВАТЕЛЬ РЖАВЧИНЫ В СПРЕЕ
- RP90 ROSTNEUTRALISATOR



- For cleaning very rusty surfaces of moving parts, e.g. bolts • Quickly penetrates to even smallest apertures • Low density, high penetrating properties

Code	Volume (ml)	Icon
42344	500	15

**4 SP90 SILICONE RELEASE/NON-STICK LUBRICANT**

- SP90 СИЛИКОНОВАЯ СМАЗКА В СПРЕЕ
- SP90 SILIKONPRÄPARAT



- Leaves a non-marking, dry film protecting surfaces • Prevents sticking of plastic and rubber components • Designed for application in a wide range of temperatures, up to +250 °C

Code	Volume (ml)	Icon
42346	500	15

**6 ZG90 COLD ZINC GALVANISE**

- ZG90 ЦИНК ГАЛЬВАНИЧЕСКИЙ В СПРЕЕ
- ZG90 KALTVERZINKT



- Pure zinc preventing corrosion, all-purpose • Perfect for galvanised surfaces and welded components • Quickly dries, binding with metal • Do not use inside cisterns • Light colour

Code	Volume (ml)	Icon
42349	500	15

**1 AMAZE DASH&BUMPER CLEANER**

- AMAZE ŚREDSTWO DO UCHODU I CZYSTKIE REZINOWYCH I PLASTYKOWYCH POWERCHNOŚCI W SALONIE AUTOMOBILA
- VALET KING PRÄPARAT ZUR REINIGUNG VON TERRIHCEN, POLSTERUNGEN



- This product is designed for cleaning PVC, rubber, wood, leather, bumpers, mudguards, dashboards, windscreen wipers and side mirrors

Code	Volume (ml)	
42352	500	15

**2 BC90 ZMYWACZ DO TARCZ HAMULCOWYCH**

- BC90 BRAKE AND CLUTCH CLEANER • BC90 ŚREDSTWO DLA CZYSTKI TORMOZNYCH DYSKÓW



- Cleaner for brake discs, clutch plates, and other soiled or oily parts and assemblies
- Effectively removes oil and grease

Code	Volume (ml)	
42353	500	15

**3 CS90 COPPER GREASE ANTI-SEIZE LUBRICANT**

- CS90 WYSOKOTEMPERATURNĄ SMAZKA W SPRZE
- CS90 CU-SCHMIERMITTEL FÜR HOHE TEMPERATUREN 1200°C

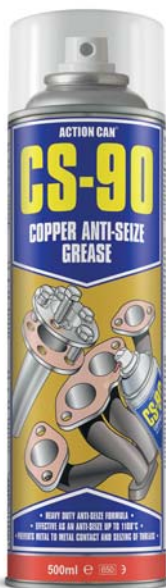

- High-temperature solid grease • Based on copper and graphite, waterresistant and lead-free • Penetrates inside chains, ropes, locks and clamps, brakes and bearings
- Does not contain silicone and chlorides
- Up to 1200°C • Offers anti-corrosion protection

Code	Volume (ml)	
42354	500	15

**4 AT90 AIR TOOL LUBRICANT**

- AT90 SMAZKA DLA PNEUMOINSTRUMENTA
- AT90 SPEZIALÖL FÜR PNEUMATISCHE GERÄTE



- Special additives in this product provide anticorrosion protection and even lubrication, increasing the lifetime of tools
- AT-90 is easy to apply and does not foam
- The product can be used for any air tools and compressors • Can be mixed with any mineral oil-based cures without the risk of excess drying of the lubricating system
- Oil parameters enable to use it for amateur and professional air tools at home or in your workshop

Code	Volume (ml)	
42356	500	12

**5 BLUE CRYSTAL GLASS CLEANER**

- ŻYDKOŚĆ DLA OCZYSZCZENIA STEKLA I OBRUDOWANIA Z NIERŻĄCEJ STALI • BLUE CRYSTAL GLASREINIGER



- Universal cleaning agent for glass, plastics, ceramic tiles, metal, and other hard surfaces • Ready to use spray for quick and easy cleaning thanks to an antistatic additive that prevents dust accumulation • No streaks or smudges

Code	Volume (ml)	
42359	750	12



PROLINE

LANTI PRO

MEGA

JUCO

OTHER BRANDS

ERDI

KLINGSPOR

EXPRESS

ACTION CAN

TRAYTON

VULCAN

# TRYTON



LITHIUM ION 18V

# T

ryton is a family of nearly 200 electrical and internal combustion-based power tools. It's a range of products designed for advanced users who need a wide range of power tools in their work. Tryton works great in shops and craft companies, supporting renovation and construction crews. The brand has been on the Polish market since 2006.

Tryton tools are designed based on proven solutions and components of the highest quality. The latter are selected, so as to guarantee long-term trouble-free operation at the most attractive price possible. Tryton power tools have all kinds of solutions that improve work comfort. Tryton tools have a great advantage in that they guarantee availability of professional service, both during the warranty period and after. The brand's owner ensures permanent availability of spare parts, allowing periodic inspections and upgrades.

Tryton - линейка изделий, насчитывающая около 200 электроинструментов и устройств на двигателях внутреннего сгорания. Это продукты, предназначенные для опытных пользователей, которым для работы требуется широкий спектр электроинструментов. Tryton прекрасно себя покажет в ремесленных компаниях и предприятиях в качестве поддержки для ремонтных и строительных бригад. Марка присутствует на польском рынке с 2006 года.

Устройства Tryton спроектированы на базе проверенных технических решений и подузлов наивысшего качества. Эти подузлы подобраны таким образом, чтобы обеспечить продолжительную безаварийную работу за наиболее привлекательную цену. В Power Tools, обозначенных маркой Tryton, мы найдем всевозможные приспособления, повышающие комфорт работы.

Огромным преимуществом машин Tryton является гарантия их профессионального сервисного обслуживания как в течение срока действия гарантии, так и по его окончании. Владелец марки обеспечивает постоянную доступность запчастей, что позволяет выполнять периодические техосмотры и модернизацию.

Tryton ist eine Familie von fast 200 Elektrowerkzeugen und Motormaschinen. Dies ist eine Produktlinie für fortgeschrittene Benutzer, die bei ihrer Arbeit ein breites Spektrum an Elektrowerkzeugen benötigen. Tryton wird in Fabriken und Handwerksbetrieben hervorragend zur Unterstützung von Reparatur- und Baupersonal eingesetzt. Die Marke ist seit 2006 auf dem polnischen Markt vertreten.

Tryton-Maschinen basieren auf bewährten Lösungen und hochwertigen Komponenten. Letztere sind so ausgewählt, dass sie einen langen störungsfreien Betrieb zum attraktivsten Preis gewährleisten. In Werkzeugen, die mit der Marke Tryton gekennzeichnet sind, finden wir alle Arten von Annehmlichkeiten, die den Komfort der Arbeit verbessern.

Der große Vorteil der Maschinen von Tryton ist die Gewährleistung eines professionellen Services während des Garantiezeitraums sowie nach dessen Ende. Der Markeninhaber gewährleistet die permanente Verfügbarkeit von Ersatzteilen, die regelmäßige Inspektionen und Aufrüstungen ermöglichen.





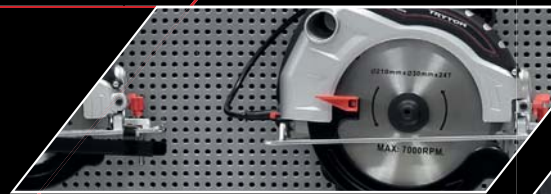

<b>TRYTON</b> I PROSTA ROBOTA	<b>TRYTON</b> I PROSTA ROBOTA	<b>TRYTON</b> I PROSTA ROBOTA	<b>TRYTON</b> I PROSTA ROBOTA	<b>TRYTON</b> I PROSTA
				
<a href="http://www.tryton-tools.pl">www.tryton-tools.pl</a>	<a href="http://www.tryton-tools.pl">www.tryton-tools.pl</a>	<a href="http://www.tryton-tools.pl">www.tryton-tools.pl</a>	<a href="http://www.tryton-tools.pl">www.tryton-tools.pl</a>	<a href="http://www.tryton-tools.pl">www.tryton-tools.pl</a>



# EXPOSITION

<b>TRYTON</b> iPROSTA ROBOTA	<b>TRYTON</b> iPROSTA ROBOTA	<b>TRYTON</b> iPROSTA ROBOTA	<b>TRYTON</b> iPROSTA ROBOTA	<b>TRYTON</b> iPROSTA ROBOTA
				
<a href="http://www.tryton-tools.pl">www.tryton-tools.pl</a>	<a href="http://www.tryton-tools.pl">www.tryton-tools.pl</a>	<a href="http://www.tryton-tools.pl">www.tryton-tools.pl</a>	<a href="http://www.tryton-tools.pl">www.tryton-tools.pl</a>	<a href="http://www.tryton-tools.pl">www.tryton-tools.pl</a>



# POWER TOOLS, GARDEN TOOLS



- accessories
- chain saws
- drills
- grinders
- impact drills
- jig saws
- mixers
- mowers
- power generators
- pumps
- rotary hammers
- trimmers
- vacuum cleaners
- and many others...



# SYSTEM 20V



## ONE BATTERY COUNTLESS POSSIBILITIES

At least a few combinations. Endless possibilities. And it all starts with one battery that can drive power tools included in the TRYTON System 20V. Drilling, driving, cutting, grinding - one battery and every job becomes more pleasant.

Tools in the TRYTON 20V system offer professional technical parameters. They were designed to assure that the user can work conveniently and to limit effects that reduce work comfort.

# SYSTEM 20V



## ОДИН АККУМУЛЯТОР МНОГО ВОЗМОЖНОСТЕЙ

По меньшей мере несколько комбинаций. Неограниченные возможности. А все начинается от одного аккумулятора, от которого Вы можете запитать электроинструменты, входящие в состав TRYTON System 20V.

Сверлите, закручиваете, режете, шлифуете - один аккумулятор, и любая работа становится наслаждением.

# SYSTEM 20V



## **EIN** AKKU **VIELE** MÖGLICHKEITEN

Zumindest ein paar Kombinationen. Unbegrenzte Möglichkeiten. Und alles beginnt mit einem Akku, den Sie mit den im TRYTON System 20V enthaltenen Elektrowerkzeugen betreiben können.

Sie bohren, schrauben, schneiden, schleifen - ein Akku und jede Arbeit ist angenehmer.

**1 CORDLESS DRILL SYSTEM 20V**

• АККУМУЛЯТОРНАЯ ДРЕЛЬ-ШУРУПОВЁРТ SYSTEM 20V • AKKU-BOHRMASCHINE SYSTEM 20V

SYSTEM 20V



TJ3LD



TJ15AK

20V  
d.c.

25Nm



• 20V, 2 speeds • 21+1 positions of clutch • LED • Keyless chuck 0,8-10 mm

Code	TJV10AL
rated voltage	20V
max. torque	25Nm
speeds	I speed 0-350/min, II speed 0-1300/min
equipment	TJ3LD charger 3-5h, TJ15AK battery Li-ion 1,5 Ah
carton quantities	5

**2 CORDLESS DRILL SYSTEM 20V**

• АККУМУЛЯТОРНАЯ ДРЕЛЬ-ШУРУПОВЁРТ SYSTEM 20V • AKKU-BOHRMASCHINE SYSTEM 20V

SYSTEM 20V



• 20V, 2 speeds • 21+1 positions of clutch • LED • Keyless chuck 0,8-10 mm

Code	TJV10
rated voltage	20V
max. torque	25Nm
speeds	I speed 0-350/min, II speed 0-1300/min
equipment	without charger; battery included
carton quantities	5

**3 CORDLESS IMPACT DRILL SYSTEM 20V**

• АККУМУЛЯТОРНАЯ ДРЕЛЬ-ШУРУПОВЁРТ С УДАРОМ SYSTEM 20V • AKKU-SCHLAGBOHRMASCHINE SYSTEM 20V

SYSTEM 20V



• 20V • 2 speeds • 21+3 positions of clutch • LED • Keyless chuck 0,8-13mm • Impact

Code	TJV20
rated voltage	20V
max. torque	44Nm
speeds	I speed 0-400/min, II speed 0-1500/min
equipment	without charger; battery included
carton quantities	5



**1 CORDLESS ANGLE GRINDER SYSTEM 20V**

- АККУМУЛЯТОРНАЯ УГЛОВАЯ ШЛИФОВАЛЬНАЯ МАШИНА SYSTEM 20V
- AKKU-WINKELSCHLEIFER SYSTEM 20V

SYSTEM 20V



- 20V • Disc diameter 115mm

Code	TJS40
rated voltage	20V
speeds	8000/min
equipment	without charger; battery included
carton quantities	5

**2 CORDLESS JIG SAW SYSTEM 20V**

- АККУМУЛЯТОРНЫЙ ЛОБЗИК SYSTEM 20V • AKKU-STICHSÄGE SYSTEM 20V

SYSTEM 20V



- 20V • Laser cutting line indicator • Foot adjustment for diagonal cuts
- T blade holder (A) • Pendulum function • Quick chuck system

Code	TJR50
rated voltage	20V
strokes	0-2400/min
max. cutting capacity wood / steel	65/6mm
equipment	without charger; battery included
carton quantities	5

**3 CORDLESS CIRCULAR SAW SYSTEM 20V**

- АККУМУЛЯТОРНАЯ ЦИРКУЛЯРНАЯ ПИЛА SYSTEM 20V • AKKU-KREISSÄGE SYSTEM 20V

SYSTEM 20V



- 20V • Laser cutting line indicator • Foot adjustment for diagonal cuts
- Saws diameter 150 mm

Code	TJP60
rated voltage	20V
No-load speed	4000/min
max. cutting capacity	48mm
equipment	without charger; battery included
carton quantities	2

**4 CORDLESS RECIPROCATING SAW SYSTEM 20V**

- АККУМУЛЯТОРНАЯ САБЕЛЬНАЯ ПИЛА SYSTEM 20V • AKKU-SÄBELSÄGE SYSTEM 20V

SYSTEM 20V

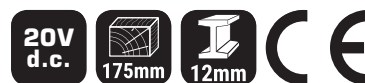

- 20V • Quick blade fixing system • LED support lighting

Code	TJPS70
rated voltage	20V
strokes	0-3000/min
max. cutting capacity wood/steel	175/12mm
equipment	without charger; battery included
carton quantities	5

PROLINE

LAHTI PRO

MEGA

JUCO

OTHER BRANDS

ERDI

KLINGSPOR

EXPRESS

ACTION CAN

TRYTON

VULCAN

**1 CORDLESS HEDGE TRIMMER SYSTEM 20V**

• АККУМУЛЯТОРНЫЕ КУСТОРЕЗЫ SYSTEM 20V • AKKU-HECKENSCHERE SYSTEM 20V



• 20V • Rotating handle

Code	TJD90
rated voltage	20V
cutting bar length	460mm
strokes	1400/min
equipment	without charger; battery included
carton quantities	4

**2 CORDLESS GARDEN BLOWER 20 V**

• АККУМУЛЯТОРНАЯ САДОВАЯ ВОЗДУХОДУВКА SYSTEM 20V • KABELLOSER GARTENBLÄSER 20 V



• 20V • 2 speeds

Code	TJE100
rated voltage	20V
air stream speed at the nozzle end	I speed -30km/h, II speed- 75km/h
equipment	without charger; battery included
carton quantities	4



**1 CHARGERS FOR LI-ION BATTERY SYSTEM20V**

- ЗАРЯДНОЕ УСТРОЙСТВО ДЛЯ АККУМУЛЯТОРНЫХ ИНСТРУМЕНТОВ LI-ION SYSTEM 20V
- LADEGERÄTE FÜR LI-IONEN-AKKU SYSTEM20V

**SYSTEM** 



- Charger SYSTEM 20V

Code	<b>TJ1LD</b>
rated voltage	20V
charging time	1h
carton quantities	20

**2 CHARGERS FOR LI-ION BATTERY SYSTEM20V**

- ЗАРЯДНОЕ УСТРОЙСТВО ДЛЯ АККУМУЛЯТОРНЫХ ИНСТРУМЕНТОВ LI-ION SYSTEM 20V
- LADEGERÄTE FÜR LI-IONEN-AKKU SYSTEM20V

**SYSTEM** 



- Charger SYSTEM 20V

Code	<b>TJ3LD</b>
rated voltage	20V
charging time	3-5h
carton quantities	50

**3 BATTERY LI-ION FOR POWERTOOLS SYSTEM 20V**

- АККУМУЛЯТОРЫ LI-ION ДЛЯ АККУМУЛЯТОРНЫХ ИНСТРУМЕНТОВ SYSTEM 20V - AKKU LI-ION FÜR POWERTOOLS SYSTEM 20V

**SYSTEM** 



- Battery SYSTEM 20V

Code	<b>TJ15AK</b>
rated voltage	20V
battery capacity	1,5 Ah
carton quantities	50

**4 BATTERY LI-ION FOR POWERTOOLS SYSTEM 20V**

- АККУМУЛЯТОР LI-ION ДЛЯ АККУМУЛЯТОРНЫХ ИНСТРУМЕНТОВ SYSTEM 20V
- AKKU LI-ION FÜR POWERTOOLS SYSTEM 20V

**SYSTEM** 



- Battery SYSTEM 20V

Code	<b>TJ2AK</b>
rated voltage	20V
battery capacity	2 Ah
comments	SAMSUNG cells
carton quantities	40

**1 CORDLESS DRIVER**

• ОТВЕРТКА АККУМУЛЯТОРНАЯ • AKKU-SCHRAUBER



- 9-positioned torque clutch • Two-positioned regulated chuck

Code	<b>TUV36</b>
rated voltage	3.6 V
battery type	Li-Ion
battery capacity	1.0 Ah
hexagonal chuck	6.35 mm (1/4")
no-load speed	180/min.
max. torque	3 Nm
equipment	3-hour charger
carton quantities	10

**3 CORDLESS DRILLS**

• АККУМУЛЯТОРНЫЕ ДРЕЛИ-ШУРУПОВЕРТЫ • AKKU-BOHRRSCHRAUBER



- Keyless chuck 0.8-10 mm • Metal gears • 21+1 clutch positions

Code	<b>TFV12/TFV18</b>
rated voltage	12V/ 18V
battery type	Li-Ion
battery capacity	1.5Ah
handle type	0.8-10 mm
speeds	1
no-load speed	0-700/min.
max. torque	15/ 18 Nm
equipment	3-hour charger, battery Li-Ion 1.5 Ah, transportation box
carton quantities	5

**2 CORDLESS DRILL**

• АККУМУЛЯТОРНАЯ ДРЕЛЬ-ШУРУПОВЁРТ • АККУ-BOHRRSCHRAUBER



- Quick action drill chuck • Metal gears • Torch included

Code	<b>TUV10L</b>
rated voltage	10.8 V
battery type	Li-Ion
battery capacity	1.3 Ah
handle type	0.8-10 mm
speeds	2
no-load speed	0-400 / 0-1500/min.
max. torque	12 Nm
equipment	1-1-h charger, 2 battery Li-Ion 1.3 Ah, torch, accessories, transportation box
carton quantities	5

**4 CORDLESS DRILL**

• АККУМУЛЯТОРНАЯ ДРЕЛЬ-ШУРУПОВЁРТ • АККУ-BOHRRSCHRAUBER



- Quick action drill chuck 0.8-10 mm • Metal gears • 21+1 clutch positions

Code	<b>TFV18B2</b>
rated voltage	18 V
battery type	Li-Ion
battery capacity	1.5 Ah
handle type	0.8-10 mm
speeds	2
no-load speed	I speed 0-400/min, II speed 0-1500/min.
max. torque	25 Nm
equipment	3-hour charger, 2 battery Li-Ion 1.5 Ah, transportation box
carton quantities	5

PROLINE  
LAHTI PRO  
MEGA  
JUCO  
OTHER BRANDS  
ERDI  
KLINGSPOR  
EXPRESS  
ACTION CAN  
TRYTON  
VULCAN



**1 CORDLESS DRILLS**

• АККУМУЛЯТОРНЫЕ ДРЕЛИ-ШУРУПОВЕРТЫ • АКАККУ-ВОHRRSCHRAUBER



Batteries of increased capacity 2Ah available (EATCV182)



- Two-speed gears • Quick action drill chuck • 15 clutch positions
- Metal gears

Code	<b>TCV18L2</b>
rated voltage	18V
battery capacity	1.5 Ah
quick action drill chuck	0.8-10 mm
speeds	2
no-load speed	I 0-400/min. / II 0-1200/min.
max. torque	28 Nm
equipment	1-1-h charger, accessories, 2 battery Li-Ion 1.5 Ah, transportation box
carton quantities	5

**3 IMPACT SCREWDRIVER**

• ШУРУПОВЕРТ АККУМУЛЯТОРНЫЙ УДАРНЫЙ • IMPACT SCHRAUBENDREHER



- Torque to 200 Nm • Hexagonal grip 6,35 mm (1/4")
- Battery charge indicator • Metal gears

Code	<b>THV18UL</b>
rated voltage	18 V
battery capacity	1.5 Ah
drill chuck	6.35 mm (1/4")
impact frequency	3000/min.
no-load speed	0-2400/min.
max. torque	200 Nm
equipment	1-1-h charger, 2 battery Li-Ion 1.5 Ah
carton quantities	5

**2 DRILL-DRIVER**

• ДРЕЛЬ-ШУРУПОВЕРТ СЕТЕВАЯ ДВУХСКОРОСТНАЯ • 2-2-GANG-NETZSCHRAUBVONNER



- Two gears • Metal planet gear (sintered powder metallurgy) • 22 clutch positions • Cord 3 m

Code	<b>TCU300</b>
power	300 W
quick action drill chuck	0.8-10 mm
no-load speed	I 0-550/min. / II 0-2100/min.
max. torque	I -36 Nm II - 23.5 Nm
drilling in steel/aluminum/wood	Ø10/16/20 mm
carton quantities	10

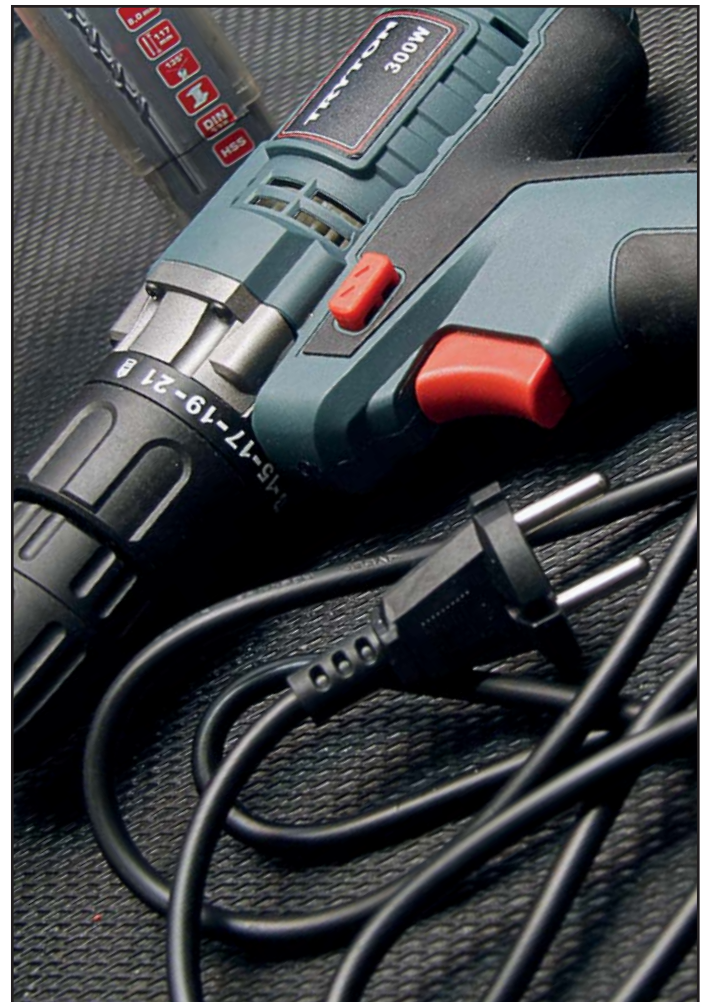

PROLINE

LANTI PRO

MEGA

JUCO

OTHER BRANDS

ERDI

KLINGSPOR

EXPRESS

ACTION CAN

TRYTON

VULCAN

**1 ELECTRIC IMPACT WRENCH**

• ГАЙКОВЕРТ УДАРНЫЙ ЭЛЕКТРИЧЕСКИЙ • ELEKTRISCHER SCHLAGSCHLÜSSEL



Code	TKU1000
power	1010W
driver	1/2"
max. torque	450 Nm
no-load speed	2200/min
equipment	4 sockets (17mm, 19mm, 21mm, 22mm), transportation box
carton quantities	4

**3 DRILL**

• ДРЕЛЬ БЕЗ УДАРА • BOHRMASCINE



• Ball bearings • Light and ergonomic design • Reversing facility

Code	TUW550
power	550 W
max. drilling capacity in steel	10 mm
max. drilling capacity in wood	16 mm
no-load speed	0-3000/min.
equipment	3 m cord, spare engine brushes
carton quantities	10

**2 DRYWALL SCREWDRIVER**

• ШУРУПОВЕРТ ДЛЯ ГИПСОКАРТОННЫХ ПЛИТ • RIGIPS-SCHRAUBER



• Power handheld tool dedicated to the gypsumboard installation  
 • Ergonomic and light-weight handheld power tool • Buckle for hanging on working belt

Code	TMGK500
power	500 W
chuck	6.35 mm (1/4")
speeds	1
no-load speed	0-1600/min.
max. torque	12 Nm
max. bit diameter	6 mm
equipment	depth limiter, transportation box
carton quantities	4

**4 HAMMER DRILLS**

• ДРЕЛИ УДАРНЫЕ • SCHLAGBOHRMASCHINEN



• Ball bearings • Light and ergonomic design • Variable speed  
 • Reversing facility

Code	TDW550/TDW710
power	550 W / 710 W
key chuck	13 mm
no-load speed	0-2700/min. / 0-3000/min.
max. drilling capacity in masonry	13 mm
max. drilling capacity in steel	10 mm
max. drilling capacity in wood	24 mm
equipment	auxiliary handle, depth limiter
carton quantities	6

**1 HAMMER DRILL**

• ДРЕЛЬ УДАРНАЯ • SCHLAGBOHRMASCHINEN



- Ball bearings • Light and ergonomic design • Variable speed
- Reversing facility • Quick action drill chuck

Code	<b>TDW850K</b>
power	850 W
quick action drill chuck	13 mm
no-load speed	0-3000/min.
max. drilling capacity in masonry	13 mm
max. drilling capacity in steel	10 mm
max. drilling capacity in wood	25 mm
equipment	auxiliary handle, depth limiter, transportation box
carton quantities	5



**2 HAMMER DRILLS**

• ДРЕЛИ УДАРНЫЕ • SCHLAGBOHRMASCHINEN



- Ball bearings • Aluminum gear box • Variable speed
- Reversing facility

Code	<b>TDW1050</b>
power	1050 W
key chuck	13 mm
no-load speed	0-3000/min.
max. drilling capacity in masonry	13 mm
max. drilling capacity in steel	10 mm
max. drilling capacity in wood	25 mm
equipment	auxiliary handle, depth limiter
carton quantities	5

**3 POWER DRILL-MIXER**

• ДРЕЛЬ-МИКСЕР • BOHRMISCHER



- Rolling bearing (dustproof) • Quenched gears • Lightweight, ergonomic structure
- The set includes drill chuck and mixer • Mixer shank M14x2

Code	<b>TMY850</b>
power	850 W
no-load speed	0-500/min.
key chuck	1.5-13 mm
max. mixer diameter	120 mm
carton quantities	4

**1 POWER MIXER**

• МИКСЕР ДЛЯ КРАСОК И РАСТВОРОВ • LEISTUNGS-MISCHER



- 2-speed gear • Aluminium gear housing • smooth start up
- Maximum stirrer diameter 120 mm • Stirrer included

Code	<b>TMX122</b>
power	1200 W
speeds	2
chuck	M14
no-load speed	0-480/0-800/min.
equipment	stirrer
carton quantities	2

**3 ROTARY HAMMER**

• ПЕРФОРАТОР 4 РЕЖИМА SDS+ • SCHLAGBOHRHAMMER



- SDS plus • 4 functions: drill, impact drill, chiseling, chisel positioning
- hardened impact set and gears

Code	<b>TMM800</b>
power	800W
drill chuck	SDS plus
impact power	2.4J
no-load speed	0-850/min
max. drilling capacity in concrete	Ø 26mm
weight	3,9kg
equipment	auxiliary handle, depth limiter
carton quantities	5

**2 POWER TWO SPINDLE MIXER**

• МИКСЕР ДВУШПИНДЕЛЬНЫЙ • ZWEISPINDELIGES RÜHRWERK



- 2-spindle mixer • 2-speed gear • Aluminum gear housing
- Available stirrers (EATH1652)

Code	<b>THX1652</b>
power	1650 W
speeds	2
chuck	quick action
no-load speed	100-420 / 150-600/min.
equipment	stirrer set
carton quantities	2

**4 ROTARY HAMMER**

• ПЕРФОРАТОР 4 РЕЖИМА SDS+ • SCHLAGBOHRHAMMER



- SDS plus • 4 functions: drill, impact drill, chiseling, chisel positioning
- Hardened impact set and gears

Code	<b>TMM900K</b>
power	900W
drill chuck	SDS plus
impact power	2.4J
no-load speed	0-850/min
max. drilling capacity in concrete	Ø 26mm
weight	5.1kg
equipment	3 drills, 2 chisels (flat and point), auxiliary handle, depth limiter, transportation box
carton quantities	4

### 1 ROTARY HAMMER 4 FUNCTIONS SDS+

• ПЕРФОРАТОР 4 РЕЖИМА SDS+ • SCHLAGBOHRHAMMER 4 FUNKTIONEN SDS+



- Ergonomic • Dust-proof ball bearings • Hardened impact set and gears • Impact drilling • Drilling • Chiseling

Code	<b>TMM710K</b>
power	710 W
chuck	sds-plus
no-load speed	930/min.
impact power	2.6 J
impact frequency	0-5000/min.
max. drilling capacity in concrete	26 mm
max. drilling capacity in steel	13 mm
max. drilling capacity in wood	40 mm
equipment	3 drills, 2 chisels, auxiliary handle, depth limiter, transportation box
carton quantities	4

### 3 ROTARY HAMMER SDS-MAX

• ПЕРФОРАТОР SDS-MAX • SCHLAGBOHRHAMMER 2 FUNKTIONEN SDS-MAX



- Overload clutch • Dust-proof ball bearings • Hardened impact set

Code	<b>TMM1050X</b>
power	1050 W
chuck	sds-max
no-load speed	480/min.
impact power	9 J
impact frequency	3750/min.
max. drilling capacity in concrete	38 mm
weight	8 kg
equipment	multiposition auxiliary handle, transportation box
carton quantities	2

### 2 ROTARY HAMMER

• ПЕРФОРАТОР SDS+ • SCHLAGBOHRHAMMER



- SDS Plus • 4 functions: drill, impact drill, chiseling, chisel positioning
- Accessories: drills 8, 10, 12 mm, chisels - flat and pointed • Rubber antidust ring

Code	<b>TMM1250</b>
power	1250W
drill chuck	SDS PLUS
impact power	5J
no-load speed	0-850/min
impact frequency	0-4500/min
drilling steel/concrete/wood	Ø13/30/40mm
carton quantities	2

### 4 ROTARY HAMMER

• ПЕРФОРАТОР SDS-MAX • SCHLAGBOHRHAMMER



- SDS Max • 3 functions: impact drill, chiseling, chisel positioning
- AVC anti-vibration system

Code	<b>TMM1350X</b>
power	1350W
drill chuck	SDS Max
impact power	14J
no-load speed	250-500/min
impact frequency	1900-3000/min
wiercenie w betonie wiertłem (optimum/maximum)	Ø 22/48mm
hole saw drilling capacity in concrete (optimum/maximum)	Ø 40/120mm
weight	7,4kg
carton quantities	1

PROLINE  
LAHTI PRO  
MEGA  
JUCO  
OTHER BRANDS  
ERDI  
KLINGSPOR  
EXPRESS  
ACTION CAN  
TRYTON  
VULCAN

### 1 DEMOLITION HAMMER SDS-MAX

• ТЯЖЁЛЫЙ ПЕРФОРАТОР ДЛЯ ДОЛБЛЕНИЯ SDS-MAX • АВВРУСННАММЕР SDS-MAX



- SDS MAX • Adjustable impact frequency • Bit positioning • Flat and pointed chisel included • Anti-vibration chuck • Additional straight side handle

Code	TMM1600X
chuck	SDS-MAX
power	1600 W
impact power	25 J
impact frequency	1000-2300/min.
weight narzędzia	9.7 kg
weight brutto (+accessories, transportation box)	16 kg
carton quantities	1

### 3 ANGLE GRINDER

• УГЛОВАЯ ШЛИФОВАЛЬНАЯ МАШИНА • WINKELSCHLEIFER



- Adjustable rotational speed • Ergonomic design • Switch with increased dust resistance • Heat treated gears

Code	TDS125RK
power	1200W
disc diameter	125 mm
no-load speed	4 000-12 000/min.
spindle	M14
carton quantities	2

### 2 ANGLE GRINDERS

• УГЛОВЫЕ ШЛИФОВАЛЬНЫЕ МАШИНЫ • WINKELSCHLEIFER



- Light weight, ergonomic design • Switch with increased dust resistance • Heat treated gears

Code	TDS125A/TDS125B
power	600W/850W
disc diameter	125 mm
no-load speed	11 000/min.
spindle	M14
carton quantities	6

### 4 ANGLE GRINDER

• УГЛОВАЯ ШЛИФОВАЛЬНАЯ МАШИНА • WINKELSCHLEIFER



- Rotary chuck • Ergonomic design • Switch with increased dust resistance • Heat treated gears

Code	TDS230
power	2350 W
disc diameter	230 mm
no-load speed	6 000/min.
spindle	M14
carton quantities	2



**1 WALL CHASER**  
• ШТРОБОРЕЗ • SCHLITZFRÄSE



• Dust protection • Adjustable depth and width of work • Ergonomic

Code	TMB1500K
power	1500 W
disc diameter	125 mm
no-load speed	8500/min.
spindle	M14
cutting depth	8 - 30 mm
cutting width	8 - 30 mm
equipment	2 diamond discs, key, mounting flanges, spacers, break-off wedge, transportation box
carton quantities	2

**2 DRYWALL SANDER**

• ШЛИФОВАЛЬНАЯ МАШИНА ДЛЯ СТЕН И ПОТОЛКОВ • WANDSCHLEIFER



• Accessories (EATHZO1): page 621

Code	THZ600
power	600 W
disc diameter	225 mm
no-load speed	1000-2000/min.
spindle	M14
equipment	6 pcs. abrasive sheets, sucking tube - 4m
carton quantities	1

**3 DRYWALL SANDER**

• ШЛИФОВАЛЬНАЯ МАШИНА ДЛЯ СТЕН • WANDSCHLEIFER



• Accessories (EATHZO1): page 621

Code	THZ800
power	800W
disc diameter	225 mm
no-load speed	1000-2600/min.
spindle	M14
equipment	6 pcs. abrasive sheets, sucking tube - 1,5 m
carton quantities	2

**1 FINISHING SANDER**

• ПЛОСКОШЛИФОВАЛЬНАЯ МАШИНА • SCHWINGSCHLEIFER



• Variable speed control • Aluminum grinder foot

Code	<b>TMC240</b>
power	240 W
pad size	90 x 187 mm
no-load speed	6000-11000/min.
oscillating frequency	12000-22000/min.
paper mounting	clamps
equipment	paper punch, two abrasive sheets (80, 120), dust box
carton quantities	5

**3 ORBITAL SANDER**

• ЭКСЦЕНТРИКОВАЯ ШЛИФОВАЛЬНАЯ МАШИНА • EXZENTERSCHLEIFER



• Variable speed control • Dustproof switch and bearings

Code	<b>TMO450A</b>
power	450 W
pad size	Ø 125 mm
no-load speed	6000 - 12000/min.
oscillating frequency	12000 - 24000/min.
paper mounting	velcro
equipment	abrasive sheet, dust box
carton quantities	10

**2 FINISHING SANDER**

• ПЛОСКОШЛИФОВАЛЬНАЯ МАШИНА • SCHWINGSCHLEIFER



• Variable speed control • Aluminum grinder foot

Code	<b>TMC350</b>
power	350 W
pad size	115 x 230 mm
no-load speed	6000-12000/min.
oscillating frequency	12000-24000/min.
paper mounting	clamps
equipment	paper punch, two abrasive sheets (80, 120), dust box
carton quantities	5

**4 BELT SANDERS**

• ЛЕНТОЧНЫЕ ШЛИФОВАЛЬНЫЕ МАШИНЫ • BANDSCHLEIFER



• Powerful motor and high speed of belt move increase the efficiency of this handheld power tool

Code	<b>TMT810/TMT810K</b>
power	810 W
belt size	76 x 533 mm
belt speed	380 m/min.
equipment	dust sack, abrasive tape
carton quantities	76 x 533 mm
	6/3



**1 BENCH GRINDERS**

• ВКОМБИНИРОВАННЫЕ ШЛИФОВАЛЬНЫЕ СТАНКИ • TISCHSCHLEIFER



- Dustproof switch and bearings • Disc for initial and finishing grinding

Code	<b>TS121501/ TS152501/ TS203501</b>
power	150 W/250 W/350 W
abrasive disc diameter	125/150/200 mm
disc hole diameter	12.7/12.7/16 mm
disc thickness: ścierniej	16/20/20 mm
no-load speed	2950/min.
equipment	fine grain abrasive disc, coarse grain abrasive disc, anti- -splash guards, workpiece support
carton quantities	1

**2 WET AND DRY BENCH GRINDER**

• КОМБИНИРОВАННЫЙ ТОЧИЛЬНО-ШЛИФОВАЛЬНЫЙ СТАНОК • SCHLEIF- UND SCHÄRFMASCHEINE



- Dustproof switch and bearings • Initial grinding disc and ability to sharpen wet

Code	<b>TS015251</b>
power	250 W
Working diameter: grinding disc	150 mm
sharpening disc	200 mm
disc hole diameter: grinding disc	12.7 mm
sharpening disc	20 mm
disc thickness: grinding disc	20 mm
sharpening disc	40 mm
no-load speed: grinding disc	2950/min.
sharpening disc	134/min.
equipment	fine grain abrasive disc (for sharpening), coarse grain abrasive disc (for grinding), anti- -splash guards, workpiece support
carton quantities	1

**3 JIG SAW**

• ЛОБЗИК • STICHSÄGE



- Quick-chuck system • Pendulum function • Variable speed

Code	<b>TMR570</b>
power	570 W
strokes	0-3000/min.
max. cutting depth wood/aluminum/steel	65/10/8 mm
equipment	parallel guide, blade, vacuum cleaner adapter
carton quantities	5

**4 JIG SAW**

• ЛОБЗИК • STICHSÄGE



- Quick-chuck system • Pendulum function • Variable speed

Code	<b>TMR712K</b>
power	710 W
strokes	0 - 3000/min.
max. cutting depth wood/aluminum/steel	80/12/10 mm
equipment	parallel guide, blade, vacuum cleaner adapter, transportation box
carton quantities	5

**1 JIG SAW**

• ЛОБЗИК • STICHSÄGE



- Quick-chuck system
- Laser pointer
- Pendulum function
- Variable speed
- Holder for blades
- Manual foot adjustment for diagonal cuts

Code	<b>TMR800K</b>
power	800 W
strokes	800 - 3100/min.
max. cutting depth wood/steel	110/10 mm
equipment	parallel guide, blade, transportation box
carton quantities	5

**2 SCROLL SAW**

• СТАНОК ЛОБЗИКОВЫЙ • DEKUPIERSÄGE



- Aluminium worktop
- Adjustable number of strokes per minute
- The set includes workspace lights
- Tilted worktop
- Accessories (EATWWO1, EATWWO2, EATWWO3): page 620

Code	<b>TWW120</b>
power	120 W
blade length	133 mm [127 mm between the mounting]
no. of strokes per minute	500-1700/min.
max. cutting thickness	57 mm - 90°, 27 mm - 45°
equipment	LED lamp, 2 blades, spanners
carton quantities	1



PROLINE  
LAHTI PRO  
MEGA  
JUCO  
OTHER BRANDS  
ERDI  
KLINGSPOR  
EXPRESS  
ACTION CAN  
TRYTON  
VULCAN

**1 RECIPROCATING SAW**

• ПИЛА САБЕЛЬНАЯ • SÄBELSÄGE



- Adjustable feet extension • Quick-chuck system

Code	TPS750
power	750 W
no-load speed	0-2700/min.
max. cutting depth w drewnie	115 mm
equipment	wood blade, metal blade
carton quantities	6

**3 CIRCULAR SAWS**

• ДИСКОВЫЕ ПИЛЫ • KREISSÄGEN



- Sawing machine foot made from aluminium

Code	THP1300/THP1600/THP1800
power	1300 W/ 1600 W/ 1800 W
disc diameter	160 mm/ 185 mm/ 210 mm
blade hole diameter	16 mm/ 20 mm/ 30 mm
no-load speed	4500/ 5000/ 5300/min.
max. cutting depth	55 mm/ 63 mm/ 75 mm
equipment	Circular saw with 18/ 24 carbide teeth, parallel guide, and instal- lation key
carton quantities	2

**2 RECIPROCATING SAW**

• ПИЛА САБЕЛЬНАЯ • SÄBELSÄGE



- Rotating handle • LED work area light • Speed controller • Adjustable feet extension • Quick-chuck system

Code	TPS1051
power	1050 W
no-load speed	800-2700/min.
max. cutting depth w drewnie	150 mm
equipment	wood blade, metal blade
carton quantities	6

**4 ELECTRIC METAL SHEET NIBBLER**

• НОЖНИЦЫ ЭЛЕКТРИЧЕСКИЕ ПО МЕТАЛЛУ • ELEKTROBLECHSCHERE



- For cutting flat, corrugated and trapezoidal steel sheet • Accessories (EATNB01, EATNB02): page 621-622

Code	TNB380K
power	380 W
no. of strokes per minute	1700/min.
max cutting depth in stainless steel	1 mm
max cutting depth in aluminium	1.8 mm
max cutting depth in plastic	2.8 mm
cutting trace width	5 mm
equipment	punches and dies, chuck, spanners, transportation box
carton quantities	5

**1 MULTI-FUNCTION SAW**  
 • ОТРЕЗНАЯ МАШИНА МНОГОФУНКЦИОНАЛЬНАЯ • MULTIFUNKTIONSTRENNSAGE



Cutting wood

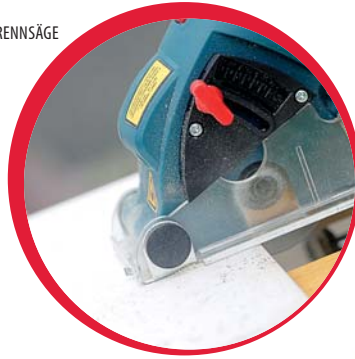

Cutting ceramics



Cutting depth adjustment



Laser cutting line indicator



Vacuum cleaner connection



Replaceable discs for cutting wood, plastics and ceramics



• For cutting wood, plastic, aluminium, tiles • Laser cutting line indicator • Accessories (EATPW01, EATPW02, EATPW03, EATPW04): page 623

Code	<b>TPW500K</b>
power	500 W
disc diameter	54.8 mm
disc opening diameter	11.1 mm
no-load speed	3900/min.
max. cutting depth	12 mm
equipment	high speed steel saw blade with 30 teeth, carbide circular saw blade with 18 teeth, diamond cutting disc for cutting ceramics, vacuum cleaner connection, spanners, transportation box
carton quantities	4

PROLINE  
LAHTI PRO  
MEGA  
JUCO  
OTHER BRANDS  
ERDI  
KLINGSPOR  
EXPRESS  
ACTION CAN  
VULCAN

**1 DUAL-BLADE SAW**

• ПИЛА ДВУХДИСКОВАЯ • DOPPELKREISSÄGE



Cutting wood and plastics



Supporting foot and guide for longitudinal cutting

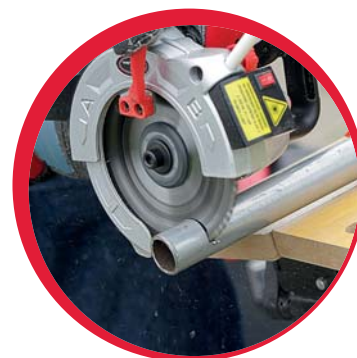

Cutting steel and non-ferrous metals



Cutting ceramics and concrete



Replaceable discs for cutting wood, metal, plastics, ceramics and concrete



Vacuum cleaner connection



• Cutting wood, steel, plastic and aluminium with a single disc (additional diamond discs must be used for tile cutting) • No reaction • Can be used for cutting in both directions • Laser cutting line indicator • Accessories (EATPD01, EATPD02, EATPD03) page 622

Code	<b>TPD860K</b>
power	860 W
disc diameter	125 mm
disc opening diameter	23/17 mm
no-load speed	3000-5500/min. 25 mm (wood, plastic)
max. cutting depth	20 mm (stone, tiles - using an additional diamond disc) 5 mm (steel, aluminium)
carton quantities	double circular saw with 30 carbide teeth, 10 lubricating inserts, supporting foot, parallel cutting guide, key, transportation box 2

**1 TILE SAW**

• ПЛИТКОРЕЗ • FLIESENSÄGE



- Dust protection

Code	<b>TG18601</b>
power	600 W
disc diameter	180 mm
disc opening diameter	22.2 mm
no-load speed	2950/min.
max. cutting capacity for 90 degree	25 mm
max. cutting capacity for 45 degree	17 mm
max. cutting length	510 mm
equipment	frame stand with legs, coolant tank, coolant pump, angle guide, assembly spanners
carton quantities	1



**2 MITRE SAW**

• УГЛОТРОЦОВОЧНАЯ ПИЛА • KIRPSÄGE



- Laser cutting line indicator • The base and bench made from high quality aluminium cast components

Code	<b>TU1450</b>
power	1450 W
disc diameter	210/216 mm
disc opening diameter	30 mm
no-load speed	5000/min.
cutting range [0°/0°]	62 x 340 mm
cutting range [0°/45°]	62 x 240 mm
cutting range [45°/0°]	34 x 340 mm
cutting range [45°/45°]	34 x 240 mm
equipment	clamps for material, circular saw with 24 sintered carbide teeth, assembly key, dust bag
carton quantities	1

**3 MITRE SAW**

• УГЛОТРОЦОВОЧНАЯ ПИЛА • KIRPSÄGE



- Laser cutting line indicator • The base and bench made from high quality aluminium cast components

Code	<b>TU1800</b>
power	1800 W
disc diameter	250/255 mm
disc opening diameter	30 mm
no-load speed	4500/min.
cutting range [0°/0°]	70 x 340 mm
cutting range [0°/45°]	70 x 240 mm
cutting range [45°/0°]	40 x 340 mm
cutting range [45°/45°]	40 x 240 mm
equipment	clamps for material, circular saw with 40 sintered carbide teeth, assembly key dust bag
carton quantities	1

**1 ELECTRIC PLANER**

• РУБАНОК ЭЛЕКТРИЧЕСКИЙ • NOBEL



- Planing depth control knob

Code	THG600
power	600 W
no-load speed	17000/min.
max. planing depth	2 mm
planing width	82 mm
equipment	double-sided blades, parallel guide, spare drive belt, dust extraction adapter
carton quantities	6

**3 ROUTER**

• ФРЕЗЕРНАЯ МАШИНА • FRÄSMASCHINE



Code	TF1201
power	1200 W
clamping bushing size	6-8 mm
no-load speed	11000-30000/min.
clamping bushing size	55 mm
equipment	parallel guide, 6 mm and 8 mm collets, dust extraction adapter
carton quantities	4

**2 ELECTRIC PLANER**

• РУБАНОК ЭЛЕКТРИЧЕСКИЙ • NOBEL



- Powerful engine enables planing up to 3 mm
- Forming function
- Planing depth control knob

Code	THG900
power	900 W
no-load speed	16000/min.
max. planing depth	3 mm
planing width	82 mm
equipment	double-sided blades, parallel guide, rabbeting depth limiter, spare drive belt, dust extraction adapter
carton quantities	6

**4 BISCUIT JOINER**

• СТАНОК ДЛЯ ФРЕЗЕРОВАНИЯ ПАЗОВ • NUTFRÄSE



- Adjustable height, depth and angle of milling
- Accessories (EATFR01, EATFR02): page 623

Code	TFR900K
power	900 W
er diameter	100 mm
cutter opening diameter	22 mm
no-load speed	11000/min.
max. milling depth	14 mm
equipment	6-toothed carbide milling cutter, chip bag, vacuum cleaner connection, key, cutters (60 pieces), transportation box
carton quantities	4

**1 MULTI-FUNCTION ROUTER**

• ФРЕЗЕРНЫЙ ИНСТРУМЕНТ УНИВЕРСАЛЬНЫЙ • MULTIFUNKTIONSFÄHRSMASCHINE



Frezowanie

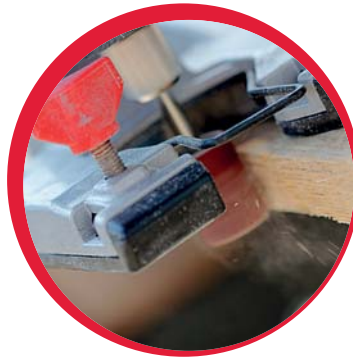

Grinding



Guide for longitudinal cutting



Cutting



Cutting, milling and grinding accessories



Vacuum cleaner connection



Multiposition handle



• Offers cutting, milling and grinding • Two-position handle • Accessories (EATFW01, EATFW02, EATFW03, EATFW04): page 622

Code	<b>TFW150K</b>
power	150 W
chuck diameter	4.8 mm
no-load speed	8500-25000/min.
body stroke	35 mm
equipment	2 carbide cutting tips, flat cutter, grinding mandrel and 8 grinding belts, edge/spine guide, vacuum cleaner connection, key, transportation box
carton quantities	2

PROLINE  
LAHTI PRO  
MEGA  
JUCO  
OTHER BRANDS  
ERDI  
KLINGSPOR  
EXPRESS  
ACTION CAN  
VULCAN



**1 VACUUM CLEANER**

- ПРОМЫШЛЕННЫЙ ПЫЛЕСОС
- STAUBSAUGER



- The set includes: universal nozzle, slot nozzle • EPA filter, foam filter, paper bag • Accessories (EATTHK01, EATTHK02, EATTHK03, EATP5, EATP3): page 621

Code	THK20
power	1250 W
displacement volume	20 l
sucking force	13kPa
air flow	58l/s
carton quantities	1

**2 VACUUM CLEANER**

- ПРОМЫШЛЕННЫЙ ПЫЛЕСОС
- STAUBSAUGER



- The set includes: universal nozzle, slot nozzle • EPA filter, foam filter, paper bag, paper bag • Accessories (EATTHK01, EATTHK02, EATTHK03, EATP5, EATP3): page 621

Code	THK31G
power	1500 W
displacement volume	30 l
sucking force	18kPa
air flow	58l/s
carton quantities	1

**3 ELECTRIC HOISTS**

- КАНАТНЫЕ ЛЕБЕДКИ • SEILWINDEN



Code	TW2001/ TW3001/ TW4001
power	450 W/550 W/750 W
max. weight:	
single line	100 kg/ 150 kg/200 kg
double line	200 kg/300 kg/400 kg
lift height:	
single line	12 m
double line	6 m
carton quantities	1

**4 WORK STATION WITH CLAMP**

- РАБОЧЕЕ МЕСТО С ЗАЖИМОМ • ARBEITSPLATZ MIT KLEMME



Code	TSR100
max. weight	100 kg
clamping range	0-420 mm
working position size (DxSxW)	680 (1040) x 900 x 840 mm
transport position size (DxSxW)	750 x 300 x 300 mm
carton quantities	1

PROLINE

LAHTI PRO

MEGA

JUCO

OTHER BRANDS

ERDI

KLINGSPOR

EXPRESS

ACTION CAN

TRYTON

VULCAN



**1 CORDLESS IMPACT WRENCH**

• УНИВЕРСАЛЬНЫЙ ОСЦИЛЛИРУЮЩИЙ ИНСТРУМЕНТ • KABELLOSER SCHLAGSCHLÜSSEL



- Quick chuck system • Variable speed control
- Accessories (EATM301A, EATM301P): page 621

Code	<b>TM301</b>
power [W]	280W
oscillating frequency [1/min.]	10 000-23 000/min.
equipment	delta foot 1 pc, delta sanding sheets 4 pcs, straight saw 1 pc, semi-circular saw 1 pc, HSS semi-circular saw 1 pc, coarse file 1 pc, 3 m cord
carton quantities	4

**2 MULTI-FUNCTION TOOL**

• УНИВЕРСАЛЬНЫЙ ОСЦИЛЛИРУЮЩИЙ ИНСТРУМЕНТ • MULTIFUNKTIONSGERÄT



- Smooth oscillation setting • Electronic stabilisation of rotations at changing loads • Function for cutting wood, non-ferrous metals, plastics and grinding • Accessories 40 pcs.
- Accessories (93126, 93110, EATM301A) page 238, 621

Code	<b>TM300</b>
power	300 W
oscillating frequency	10000-18000/min.
equipment	delta foot, delta sanding sheets, straight saw, semi-circular saw, extended semi-circular saw, coarse file
carton quantities	10

**3 MINISZLIFIERKA WIELOFUNKCYJNA**

• MINI GRINDER • МИНИ-ШЛИФОВАЛЬНАЯ МУЛЬТИФУНКЦИОНАЛЬНАЯ МАШИНА



- Variable speed control • Flexible drive shaft • Accessories 40 pcs.
- Accessories (93171): page 237

Code	<b>TMG170</b>
power	170 W
no-load speed	8 000-35 000/min.
equipment	flexible shaft, reduction sleeves, cutting and grinding accessories
carton quantities	10

**1 MINI GRINDER**

• МИНИ-ШЛИФОВАЛЬНАЯ МУЛЬТИФУНКЦИОНАЛЬНАЯ МАШИНА • MINISCHLEIFGERÄT



Cutting with an abrasive disc



Grinding



Polishing



Electronic speed control with LCD display



Hanging facility



Auxiliary handle



Milling attachment



• Variable speed control • LCD display • Milling attachment • Accessories (93171): page 237



Code	<b>TMG170K</b>
power	170 W
no-load speed	8 000-35 000/min.
equipment	flexible shaft, stand, mounting bracket, reduction sleeves, cutting and grinding accessories
carton quantities	6

**1 HEAT GUN**

• ПИСТОЛЕТ ГОРЯЧЕГО ВОЗДУХА • HEISSLUFTPISTOLE



- Cord 3 m • 3 working range • Control method preventing machine overheatingm
- For removing paint coatings, forming and welding plastics, shrinking shrink films, softening glue and defrosting water pipes

Code	<b>THL1800</b>
power	1800 W
working range	I-50 °C,250l/min; II-450 °C, 250l/min; III-550 °C, 500l/min
carton quantities	8

**2 HEAT GUN**

• ПИСТОЛЕТ ГОРЯЧЕГО ВОЗДУХА • HEISSLUFTPISTOLE



- Cord 3m • Smooth, electronic temperature and air flow control
- Control method preventing machine overheatingm • For removing paint coatings, forming and welding plastics, shrinking shrink films, softening glue and defrosting water pipes

Code	<b>THL2000B</b>
power	2000 W
working range	I-50 °C,250l/min; II-50-450 °C, 250l/min; III-90-600 °C, 500l/min
carton quantities	8

**3 HEAT GUN**

• ПИСТОЛЕТ ГОРЯЧЕГО ВОЗДУХА • HEISSLUFTPISTOLE



- Cord 3 m • Smooth, electronic temperature and air flow control
- LCD display • Control method preventing machine overheatingm
- 4 ranges of settings memory • For removing paint coatings, forming and welding plastics, shrinking shrink films, softening glue and defrosting water pipes

Code	<b>THL2000C</b>
power	2000W
working range	I-50 °C,250-500l/min; II-50-650 °C, 250-500l/min
carton quantities	8

**4 HEAT GUN ACCESSORIES**

• ПРИНАДЛЕЖНОСТИ ДЛЯ ПИСТОЛЕТОВ ГОРЯЧЕГО ВОЗДУХА • ZUBEHÖR FÜR HEISSLUFTGEBLÄSE



- Nozzles, 4 items • Scraper, 1 piece

Code	<b>EATL5</b>
carton quantities	40

**1 ELECTRIC CHAINSAW**

• ПИЛА ЦЕПНАЯ ЭЛЕКТРИЧЕСКАЯ • ELEKTRO-KETTENSÄGE



- Sawing machine with transverse engine
- Toolless control of chain saw tension

Code	TOC40203
power	2000 W
guide bar	40 cm
chain pitch	3/8"
weight	5 kg
equipment	chain, guide, fixing spanners
carton quantities	2

**2 ELECTRIC CHAINSAW**

• ПИЛА ЦЕПНАЯ ЭЛЕКТРИЧЕСКАЯ • ELEKTRO-KETTENSÄGE



- Sawing machine with lengthwise engine
- Toolless control of chain saw tension

Code	TOC40242
power	2400 W
guide bar	40 cm
chain pitch	3/8"
weight	6 kg
equipment	chain, guide, fixing spanners
carton quantities	2



PROLINE

LAHTI PRO

MEGA

JUCO

OTHER BRANDS

EMDI

KLINGSPOR

EXPRESS

ACTION SAW

TRYTON

VULCAN

PROLINE

LANTI PRO

MEGA

JUCO

OTHER BRANDS

ERDI

KLINGSPOR

EXPRESS

ACTION CAN

TRYTON

VULCAN

**1 PETROL CHAINSAW**

• ЦЕПНАЯ БЕНЗИНОВАЯ ПИЛА • BENZIN-KETTENSÄGE



- Sawing machine for a demanding do-it-yourselfer

Code	<b>TOR45231</b>
engine type	two stroke
displacement volume	45,2 cm <sup>3</sup>
max power	1,5 kW (2,1 KM)
guide bar	45 cm
chain pitch	0,325"
weight	4,85 kg
equipment	chain, guide, fixing spanners, container for the fuel mixture
carton quantities	1

**3 PETROL CHAINSAW**

• ЦЕПНАЯ БЕНЗИНОВАЯ ПИЛА • BENZIN-KETTENSÄGE



- Sawing machine for a demanding do-it-yourselfer and for professional applications

Code	<b>TOR201P</b>
engine type	two stroke
displacement volume	39,6 cm <sup>3</sup>
max power	1,5 kW (2,1 KM)
guide bar	40 cm
chain pitch	3/8"
weight	4,3 kg
equipment	chain, guide, fixing spanners, container for the fuel mixture
carton quantities	1

**2 PETROL CHAINSAW**

• ЦЕПНАЯ БЕНЗИНОВАЯ ПИЛА • BENZIN-KETTENSÄGE



- Sawing machine for a demanding do-it-yourselfer

Code	<b>TOR50291</b>
engine type	two stroke
displacement volume	49,2 cm <sup>3</sup>
max power	2,1 kW (2,9 KM)
guide bar	50 cm
chain pitch	0,325"
weight	5,4 kg
equipment	chain, guide, fixing spanners, container for the fuel mixture
carton quantities	1

**4 PETROL CHAINSAW**

• ЦЕПНАЯ БЕНЗИНОВАЯ ПИЛА • BENZIN-KETTENSÄGE



- Sawing machine for a demanding do-it-yourselfer and for professional applications

Code	<b>TOR241P</b>
engine type	two stroke
displacement volume	45,6 cm <sup>3</sup>
max power	1,8 kW (2,5 KM)
guide bar	45 cm
chain pitch	0,325"
weight	4,9 kg
equipment	chain, guide, fixing spanners, container for the fuel mixture
carton quantities	1

**1 ELECTRIC HEDGE TRIMMER**

• ЭЛЕКТРИЧЕСКИЕ НОЖНИЦЫ ДЛЯ ЖИВОЙ ИЗГОРОДИ • HECKENSCHERE MIT DREHGRIFF



- Rotating handle

Code	TOD51501
power	500 W
cutting bar length	51 cm
max. cutting thickness	16 mm
weight	2,35 kg
carton quantities	4

**2 ELECTRIC HEDGE TRIMMER**

• ЭЛЕКТРИЧЕСКИЕ НОЖНИЦЫ ДЛЯ ЖИВОЙ ИЗГОРОДИ • HECKENSCHERE MIT DREHGRIFF



- Rotating handle • Quenched blades

Code	TOD61621
power	620 W
cutting bar length	61 cm
max. cutting thickness	20 mm
weight	3,85 kg
carton quantities	4



PROLINE

LAHTI PRO

MEGA

JUCO

OTHER BRANDS

EKO

KLINGSPOR

EXPRESS

ACTION CAN

TRYTON

VULCAN

**1 GARDEN VACUUM / BLOWER**

• ПЫЛЕСОС САДОВЫЙ ДЛЯ УБОРКИ ЛИСТЬЕВ • GARTENSTAUBSAUGER / GEBLÄSE



- Convenient switching between the vacuum with grinder and the blower functions
- Smooth speed control allow adjustment of blower power to the working conditions

Code	<b>TOE3000</b>
power	3000 W
no-load speed	8000 - 14000 /min.
max. air flow	13.5 m <sup>3</sup> /min.
max. airflow speed	275 km/h
weight	4.5 kg
equipment	shoulder strap, 45 litre bag
carton quantities	1

**3 GRASS TRIMMER**

• ЭЛЕКТРИЧЕСКИЙ ТРИМЕР • GRASTRIMMER



- Adjustable rod length and head position

Code	<b>TOB650</b>
power	650 W
planing width	29 cm
no-load speed	11000/min.
weight	3 kg
carton quantities	4

**2 GRASS TRIMMER**

• ЭЛЕКТРИЧЕСКИЙ ТРИМЕР • GRASTRIMMER



- Automatic string extension during „Tap&Go” operation

Code	<b>TOB25301</b>
power	300 W
width of trimming with a string	24 cm
no-load speed	11500/min.
weight	2 kg
carton quantities	6





**1 PETROL BRUSH CUTTER**

• БЕНЗИНОВАЯ КОСИЛКА • BENZIN-RASENTRIMMER



- Trimmer with two-stroke engine
- Divided drive shaft for easier transport and storage

Code	<b>TOP252S</b>
engine type	two stroke
displacement volume	51,7 cm <sup>3</sup>
placement volume	1,4 kW [1,9 KM]
width of trimming with a string	44 cm
width of trimming with a blade	25 cm
weight	7,5 kg
equipment	knife, trimmer line head, braces, container for the fuel mixture
carton quantities	1

**2 PETROL BRUSH CUTTER**

• БЕНЗИНОВАЯ КОСИЛКА • BENZIN-RASENTRIMMER



- Trimmer with four-stroke engine (no need to use a fuel mixture)
- Divided drive shaft for easier transport and storage

Code	<b>TOP431S</b>
engine type	four stroke
displacement volume	31,0 cm <sup>3</sup>
placement volume	0,8 kW [1,09 KM]
width of trimming with a string	44 cm
width of trimming with a blade	25 cm
weight	7,6 kg
equipment	knife, trimmer line head, braces
carton quantities	1

**3 SUBMERSIBLE PUMP FOR DIRTY AND CLEAN WATER**

• НАСОС ПОГРУЖНОЙ ДЛЯ ЧИСТОЙ И ГРЯЗНОЙ ВОДЫ • TAUCHPUMPE FÜR VERSCHMUTZTES UND SAUBERES WASSER

230V  
-50Hz

10 m



- Three flow settings for clean and dirty water
- Powerful motor with copper winding
- Float switch

Code	<b>TPB750</b>
power	750 W
max. immersion depth	7 m
max. pumping height	9 m
capacity	13000 l/h
weight	5.4 kg
carton quantities	4

**4 SUBMERSIBLE PUMP FOR DIRTY WATER**

• НАСОС ПОГРУЖНОЙ ДЛЯ ГРЯЗНОЙ ВОДЫ • TAUCHPUMPE FÜR SCHMUTZWASSER

230V  
-50Hz

10 m



- Body cover made of stainless steel
- Powerful motor with copper winding
- Float switch

Code	<b>TPB1100</b>
power	1100 W
max. immersion depth	7 m
max. pumping height	11 m
capacity	15000 l/h
weight	5.8 kg
carton quantities	4

**1 PRESSURE WASHERS**

• МОЙКИ ВЫСОКОГО ДАВЛЕНИЯ • HOCHDRUCKREINIGER



• Aluminum pump • AUTO-STOP function

Code	TM16105	TM18135
engine type	brush	brush
power	1650 W	1850 W
maximum pressure	10.5 Mpa (105 bar)	13.5 Mpa (135 bar)
working pressure	7 Mpa (70 bar)	9 Mpa (90 bar)
max. capacity	7,1 l/min.	7,1 l/min.
max. rated capacity	5.7 l/min.	5.7 l/min.
water temperature	5° - 50°C	5° - 50°C
weight	10.5 kg	11 kg
equipment	spray gun, fan lance with flow regulation, lance extension, 5 meter pressure hose	spray gun, fan lance with flow regulation, rotary lance, lance extension, 5 meter pressure hose
carton quantities	1	1

**2 PRESSURE WASHER**

• МОЙКА ВЫСОКОГО ДАВЛЕНИЯ  
• HOCHDRUCKREINIGER



• Durable inductive engine • Aluminum pump • AUTO-STOP function

Code	TM18165
engine type	inductive
power	1800 W
maximum pressure	16.5 Mpa (165 bar)
working pressure	11 Mpa (110 bar)
max. capacity	6,8 l/min.
max. rated capacity	5.5 l/min.
water temperature	5° - 50°
weight	18 kg
equipment	spray gun, fan lance with flow regulation, rotary lance, lance extension, 5 meter pressure hose
carton quantities	1



**1 ELECTRIC LAWN MOWER**

• ЭЛЕКТРИЧЕСКАЯ ГАЗОНОКОСИЛКА • ELEKTRO-RASENMÄHER

230V  
-50Hz

Code	<b>TOA32122</b>
power	1100 W
planing width	32 cm
height regulation	3 steps
cart material	plastic
basket material	plastic
weight	6,8 kg
carton quantities	1

**3 SELF PROPELLED PETROL LAWN MOWER**

• ГАЗОНОКОСИЛКА БЕНЗИНОВАЯ САМОХОДНАЯ • BENZIN-RASENMÄHER MIT ANTRIEB



- 3-in-1 mower with a drive
- Wheels with bearings
- High-quality gearing

Code	<b>TOK4642B</b>
engine	Briggs&Stratton series 500E
displacement volume	140 cm <sup>3</sup>
max. torque	6,8 Nm
planing width	46 cm
height regulation	central (25 - 90 mm)
wheel size	front 7" / rear 8"
functions	discharge to the basket, side discharge, mulching
basket material	textil
basket displacement volume	60 l
weight	30 kg
carton quantities	1

**2 ELECTRIC LAWN MOWER**

• ЭЛЕКТРИЧЕСКАЯ ГАЗОНОКОСИЛКА • ELEKTRO-RASENMÄHER

230V  
-50Hz

Code	<b>TOA38141</b>
power	1400 W
planing width	38 cm
height regulation	3 steps
cart material	plastic
basket material	plastic
weight	8,7 kg
carton quantities	1

**4 SELF PROPELLED PETROL LAWN MOWER**

• ГАЗОНОКОСИЛКА БЕНЗИНОВАЯ САМОХОДНАЯ • BENZIN-RASENMÄHER MIT ANTRIEB



- 3-in-1 mower with a drive
- Wheels with bearings
- High-quality gearing

Code	<b>TOK5362B</b>
engine	Briggs&Stratton 750EX Ready Start series
displacement volume	161 cm <sup>3</sup>
max. torque	9,5 Nm
planing width	53 cm
height regulation	central (25 - 80 mm)
wheel size	front 8" / rear 9,5"
functions	discharge to the basket, side discharge, mulching
basket material	plastic/textil
basket displacement volume	65 l
weight	37 kg
carton quantities	1

PROLINE  
LAHTI PRO  
MEGA  
JUCO  
OTHER BRANDS  
ERDI  
KLINGSPOR  
EXPRESS  
ACTION CAN  
TRYTON  
VULCAN

**1 SELF PROPELLED PETROL LAWN MOWER**

• ГАЗОНОКОСИЛКА БЕНЗИНОВАЯ САМОХОДНАЯ • BENZIN-RASENMÄHER MIT ANTRIEB



- 3-in-1 mower with a drive • Wheels with bearings • High-quality gearing

Code	<b>TOK4633C</b>
engine type	four stroke, overhead valve
displacement volume	139 cm <sup>3</sup>
max power	1,5 kW (2,1 KM)
planing width	46 cm
height regulation	central (25 - 90 mm)
wheel size	front 7" / rear 8"
functions	discharge to the basket, side discharge, mulching
basket material	textil
basket displacement volume	60 l
weight	33,5 kg
carton quantities	1

**2 SELF PROPELLED PETROL LAWN MOWER**

• ГАЗОНОКОСИЛКА БЕНЗИНОВАЯ САМОХОДНАЯ • BENZIN-RASENMÄHER MIT ANTRIEB



- 4-in-1 mower with a drive • Additional back discharge • Wheels with bearings • High-quality gearing

Code	<b>TOK5152B</b>
engine	Briggs&Stratton 625E Ready Start series
displacement volume	150 cm <sup>3</sup>
max. torque	8,5 Nm
planing width	51 cm
height regulation	central (20 - 75 mm)
wheel size	front 8" / rear 9,5"
functions	discharge to the basket, side discharge, back discharge, mulching
basket material	plastic/textil
basket displacement volume	65 l
weight	35 kg
carton quantities	1

**3 SELF PROPELLED PETROL LAWN MOWER**

• ГАЗОНОКОСИЛКА БЕНЗИНОВАЯ САМОХОДНАЯ • BENZIN-RASENMÄHER MIT ANTRIEB



Central height adjustment



Discharge to the basket, side discharge, back discharge, mulching



Auxiliary handle for carrying



Electronic engine start



- Electronic starter • 4-in-1 mower with a drive • Additional back discharge • Wheels with bearings • Large rear wheels • High-quality gearing

Code	<b>TOK5362I</b>
engine	Briggs&Stratton 775JS Instart series
displacement volume	161 cm <sup>3</sup>
max. torque	9,5 Nm
planing width	53 cm
height regulation	central (15 - 80 mm)
wheel size	front 8" / rear 12"
functions	discharge to the basket, side discharge, back discharge, mulching
basket material	plastic/textil
basket displacement volume	65 l
weight	40 kg
carton quantities	1

**1 PETROL POWER GENERATOR**

• ГЕНЕРАТОР ЭЛЕКТРИЧЕСКОГО ТОКА • BENZIN-STROMERZEUGER



- AVR voltage stabilization system
- \*Folded handles and transport wheels (model TCG2000K)

Code	TCG2000 / TCG2000K*	
	Engine	
model	168F	
type	four stroke	
placement volume	163 cm <sup>3</sup>	
max power / no-load speed	5.5 kW / 3000/min	
fuel tank	15 l	
	Generator	
placement volume	2,0 kW	
max power	2,2 kW	
outputs:	2 x 230V	
	1 x 12V	
AVR system	yes	
maximum working time with a single tank top-up	10,6 h	
weight	35 kg/37 kg	
carton quantities	1	

**2 PETROL POWER GENERATOR**

• ГЕНЕРАТОР ЭЛЕКТРИЧЕСКОГО ТОКА • BENZIN-STROMERZEUGER



- Supplying devices with 230V (single-phase) and 400V (three-phase) voltage
- Copper generator winding
- AVR voltage stabilization system
- Folded handles and transport wheels

Code	TCG5000K	
	Engine	
model	188F	
type	four stroke	
placement volume	389 cm <sup>3</sup>	
max power / no-load speed	8 kW / 3600/min	
fuel tank	25 l	
	Generator (three-phase)	
placement volume	5,0 kW	
max power	5,5 kW	
outputs:	1 x 400V	
	2 x 230V	
	1 x 12V	
AVR system	tak	
maximum working time with a single tank top-up	8,2 h	
weight	83 kg	
carton quantities	1	



**1 GARDEN MACHINERY OILS**

• СМАЗКИ ДЛЯ САДОВОЙ ТЕХНИКИ • ÖLE FÜR GARTENGERÄTE



**11**

SAPP: Can be mixed with other oils for chain saw guides, based on mineral and vegetable oils

VISCOSITY PN-EN-ISO 3104:2004 - 70-90 mm<sup>2</sup>/s

SA2T: API TC, JASO FC, ISO EGC. Semi-synthetic oil for lubricating 2-stroke combustion engines - lubricated with a mixture system

VISCOSITY PN-EN-ISO 3104:2004 - 9.0 - 11.0 mm<sup>2</sup>/s

SA4T: API SG/CD Oil for 4-stroke engines in gardening equipment

LVISCOSITY TO SAE - 30

Code	Used	
SAPP	saw guides	12
SA2T	2 stroke engines	12
SA4T	4 stroke engines	12

**5 SCROLL SAW BLADES FOR TWW120**

• ПОЛОТНА ПИЛЬНЫЕ ДЛЯ ЛОБЗИКОВОГО СТАНКА TWW120  
• DEKUPIERSÄGEBLÄTTER FÜR TWW120



• Length 133 mm (127 mm between the mounting)

Code	Quantity [pcs.]	Tooth quantity/cal		
EATWW01	3	10	x	12/120
EATWW02	3	18	x	12/120
EATWW03	3	24	x	12/120

**2 DRILL CHUCKS**

• ПАТРОНЫ СВЕРЛИЛЬНЫЕ • BOHRFUTTER



- Spindle 1/2 UNF
- EATM3UWB, EATM4UWB: Automatic LOCK-SYSTEM to prevent the handle from getting loose during the work
- EATM4UWB: for impact drills

Code	<b>EAVM1UWK</b>
range	1.5-13
type	key
Code	<b>EATM2UWB</b>
range	1.5-13
type	quick action
Code	<b>EATM3UWB</b>
range	1.5-13
type	quick coupling with a lock
Code	<b>EATM4UWB</b>
range	1.5 - 13
type	quick coupling with a lock, full-metal
carton quantities	5/50

**3 DRILL CHUCK KEYS**

• КЛЮЧИ ДЛЯ СВЕРЛИЛЬНЫХ ПАТРОНОВ • SCHLÜSSEL FÜR BOHRFUTTER



- Made from high-quality materials, hardness 45HRC
- Designed for the most popular drills with a key chuck
- For chuck 6/8/10mm - 11 teeth, for chuck 10/13mm - 11 teeth, for chuck 13mm - 10 teeth

Code	Length [mm]		
31388	6/8/10 mm - 11 teeth	x	24/96
31389	10/13 mm - 11 teeth	x	24/96
31390	13 mm - 10 teeth	x	24/96

**4 VICE FOR BENCH DRILLS**

• ТИСКИ ДЛЯ НАСТОЛЬНО-СВЕРЛИЛЬНЫХ СТАНКОВ  
• SCHRAUBSTOCK FÜR TISCHBOHRMASCHINEN



EATWS01 - dedicated to drill TWS350  
EATWS02 - dedicated to drill k TWS500, TWS550

Code	Jaw width [mm]		
EATWS01	65	x	10
EATWS02	80	x	10



**1 ACCESSORIE SET FOR MULTIFUNCTION TOOLS**  
 • ПРИНАДЛЕЖНОСТИ ДЛЯ УНИВЕРСАЛЬНОГО ОСЦИЛЛИРУЮЩЕГО ИНСТРУМЕНТА (НАПР. ТМ301, ТМ300)  
 • ZUBEHÖRSET FÜR MULTIFUNKTIONSWERKZEUGE



• Straight saw 1 pc • Semi-circular saw 1 pc  
 • Delta foot 1 pc • Coarse file 1 pc • Semi-circular saw

Code		
EATM301A	x	40

**2 SAND SHEETS „DELTA“ FOR MULTI-FUNCTION TOOL (EX. ТМ300,ТМ301) AND FINISHING SANDERS**  
 • БУМАГА НАЖДАЧНАЯ DELTA ДЛЯ УНИВЕРСАЛЬНОГО ОСЦИЛЛИРУЮЩЕГО ИНСТРУМЕНТА (НАПР. ТМ300, ТМ301) И ОСЦИЛЛЯЦИОННЫХ ШЛИФОВАЛЬНЫХ МАШИН • SANDPLATTEN „DELTA“ FÜR MULTIFUNKTIONSWERKZEUG (EX. ТМ300, ТМ301) UND BEARBEITUNGSSCHLEIFER



• 10 pcs. (granulation 2x80, 2x120, 3x180, 3x240)

Code		
EATM301P	x	60

**3 SAND DISCS**  
 • ШЛИФОВАЛЬНЫЕ КРУГИ • SANDSCHEIBEN



• For THZ600 i THZ800 • Ø 225 mm  
 • Granulation: 80/ 100/ 120/ 150/ 180/ 240  
 • 6 pcs.

Code	
EATHZ01	100

**4 EPA FILTER**  
 • ЕРА-ФИЛЬТР • ЕРА-FILTER



• Dedicated to vacuum cleaner THK31G

Code	
EATTHK02	1

**5 EPA FILTER**  
 • ЕРА-ФИЛЬТР • ЕРА-FILTER



• Dedicated to vacuum cleaner THK20

Code	
EATTHK09	1

**6 SPONGE FILTER**  
 • ГУБЧАТЫЙ ФИЛЬТР • SCHWAMMFILTER



• Dedicated to vacuum cleaner THK31G

Code	
EATTHK03	1

**7 SPONGE FILTER**  
 • ГУБЧАТЫЙ ФИЛЬТР • SCHWAMMFILTER



• Dedicated to vacuum cleaner THK20

Code	
EATTHK10	1

**8 PAPER DUST BAG**  
 • БУМАЖНЫЕ ПАКЕТЫ • PAPIERSTAUBBEUTEL



• Dedicated to vacuum cleaner THK31G, THK20 • 5 pcs.

Code		
EATTHK01	x	40

**9 PAPER DUST BAG**  
 • БУМАЖНЫЕ ПАКЕТЫ • PAPIERSTAUBBEUTEL



• Dedicated to vacuum cleaner THK31G, THK20  
 • 5 pcs.

Code	
EATP5	13

**10 FLEECE DUST BAG**  
 • ФЛИЗЕЛИНОВЫЕ ПАКЕТЫ • VLIESTAUBBEUTEL



• Dedicated to vacuum cleaner THK31G, THK20 • High tear resistance • Very good air flow even with a full bag

Code	
EATP3	20

**11 CUTTER BLADE AND HOLDER FOR METAL SHEET NIBBLER TNB380K**  
 • ПУАНСОН И МАТРИЦА ДЛЯ ПЛОСКИХ И ТРАПЕЦИЕВИДНЫХ МЕТАЛЛИЧЕСКИХ ЛИСТОВ – ДЛЯ ЭЛЕКТРИЧЕСКИХ НОЖИЦ ПО МЕТАЛЛУ TNB380K • STEMPEL UND MATRIZE FÜR FLACH- UND TRAPEZBLECHE FÜR ELEKTROBLECHSCHERE TNB380K



Code		
EATNB01	x	500

PROLINE

LAHTI PRO

MEGA

JUCO

OTHER BRANDS

ERDI

KLINGSPOR

EXPRESS

ACTION CAN

TRYTON

VULCAN

**1 CUTTER BLADE AND HOLDER FOR METAL SHEET NIBBLER TNB380K**  
 • ПУАНСОН И МАТРИЦА ДЛЯ ПЛОСКИХ И ПРОФИЛИРОВАННЫХ МЕТАЛЛИЧЕСКИХ ЛИСТОВ – ДЛЯ ЭЛЕКТРИЧЕСКИХ НОЖИЦ ПО МЕТАЛЛУ TNB380K • STEMPSEL UND MATRIZE FÜR WELLEN- UND TRAPEZBLECHE FÜR ELEKTROBLECHSCHERE TNB380K



Code		
EATNB02	x	250

**2 CUTTING SAW FOR DUAL-BLADE SAW TPD860K**  
 • ДИСК ОТРЕЗНОЙ ДЛЯ ДВУХДИСКОВОЙ ПИЛЫ TPD860K  
 • SÄGEBLÄTTER FÜR DOPPELKREISSÄGE TPD860K



• Diameter 125 mm

Code		
EATPD01	x	20

**3 DIAMOND DISC FOR DUAL-BLADE SAW TPD860K**  
 • ДИСК АЛМАЗНЫЙ ДЛЯ ДВУХДИСКОВОЙ ПИЛЫ TPD860K  
 • DIAMANTSÄGEBLÄTTER FÜR DOPPELKREISSÄGE TPD860K 125X30MM



• Diameter 125 mm

Code		
EATPD02	x	20

**4 LUBRICATE STICKS FOR DUALBLADE SAW TPD860K**  
 • ВКЛАДЫШИ СМАЗОЧНЫЕ ДЛЯ ДВУХДИСКОВОЙ ПИЛЫ TPD860K  
 • 10 ШТ - ПОПОЛИЕРПАД FÜR WINKELSCHLEIFER - POLIERER TSP710K



• 10 pcs.

Code		
EATPD03	x	100



**5 CUTTING AND MILLING SET FOR MULTI-FUNCTION ROUTER TF-W150K**  
 • КОМПЛЕКТ ДЛЯ РЕЗКИ И ФРЕЗЕРОВАНИЯ – ДЛЯ МНОГОФУНКЦИОНАЛЬНОГО ФРЕЗЕРНОГО СТАНКА TFW150K  
 • SCHNEID - FRÄS - SATZ FÜR MULTIFUNKTIONSFRÄSE TFW150K



• 2 cutting drills • 2 cutters for flatpatterns

Code		
EATFW01	x	50

**6 SANDING SET FOR MULTI-FUNCTION ROUTER TFW150K**  
 • КОМПЛЕКТ ДЛЯ ШЛИФОВКИ ДЛЯ МНОГОФУНКЦИОНАЛЬНОГО ФРЕЗЕРНОГО СТАНКА TFW150K • SCHLEIFSATZ FÜR MULTIFUNKTIONSFRÄSE TFR150K



• 25 pcs.  
 • Mandrel and grinding tape P40/60/80/100/120/180/220/240

Code		
EATFW02	x	30

**7 ZESTAW SZLIFUJĄCY DO FREZARKI WIELOFUNKCYJNEJ TFW150K**  
 • SANDING SET FOR MULTI-FUNCTION ROUTER TFW150K  
 • КОМПЛЕКТ ДЛЯ ШЛИФОВКИ ДЛЯ МНОГОФУНКЦИОНАЛЬНОГО ФРЕЗЕРНОГО СТАНКА TFW150K



• 20 pcs.  
 • Grinding tapes 5x P40/60/80/100

Code		
EATFW03	x	30

**8 SANDING SET FOR MULTI-FUNCTION ROUTER TFW150K**  
 • КОМПЛЕКТ ДЛЯ ШЛИФОВКИ ДЛЯ МНОГОФУНКЦИОНАЛЬНОГО ФРЕЗЕРНОГО СТАНКА TFW150K • SCHLEIFSATZ FÜR MULTIFUNKTIONSFRÄSE TFR150K



• 20 pcs.  
 • Grinding tapes 5x P120/180/220/240

Code		
EATFW04	x	30



**1 SET OF CUTTING SAWS FOR MULTI-FUNCTION SAW TPW500K**  
 • НАБОР ОТРЕЗНЫХ ДИСКОВ ИЗ БЫСТРОРЕЖУЩЕЙ СТАЛИ ДЛЯ МНОГОФУНКЦИОНАЛЬНОЙ ОТРЕЗНОЙ МАШИНЫ TPW500K  
 • HSS-SÄGEBLATTSATZ FÜR MULTIFUNKTIONSTRENN-SÄGE TPW500K



• 3 pcs. • 54.8 x 11.1 mm

Code		
EATPW01	x	100

**2 SET OF CUTTING SAWS FOR MULTIFUNCTION SAW TPW500K**  
 • НАБОР ДИСКОВ «MIX» ДЛЯ МНОГОФУНКЦИОНАЛЬНОЙ ОТРЕЗНОЙ МАШИНЫ TPW500K • SÄGEBLATTSATZ MIX FÜR MULTIFUNKTIONSTRENN-SÄGE TPW500K



• 3 pcs. • 54.8 x 11.1 mm

Code		
EATPW04	x	100

**3 SET OF DIAMOND DISCS FOR MULTI-FUNCTION SAW TPW600K**  
 • НАБОР АЛМАЗНЫХ ДИСКОВ ДЛЯ МНОГОФУНКЦИОНАЛЬНОЙ ОТРЕЗНОЙ МАШИНЫ TPW600K • DIAMENTSÄGEBLATTSATZ FÜR MULTIFUNKTIONSTRENN-SÄGE TPW600K



• 3 pcs. • 89 x 10 mm • Suits Dexter tools

Code		
EATPW07	x	50

**4 SET OF CUTTING SAWS FOR MULTI-FUNCTION SAW TPW600K**  
 • НАБОР ДИСКОВ «MIX» ДЛЯ МНОГОФУНКЦИОНАЛЬНОЙ ОТРЕЗНОЙ МАШИНЫ TPW600K • SÄGEBLATTSATZ MIX FÜR MULTIFUNKTIONSTRENN-SÄGE TPW600K



• 3 pcs. • 89 x 10 mm • Suits Dexter tools

Code		
EATPW08	x	50

**5 SET OF CUTTING SAWS FOR MULTI-FUNCTION SAW TPW500K**  
 • НАБОР ОТРЕЗНЫХ ДИСКОВ ИЗ ТВЕРДЫХ СПЛАВОВ ДЛЯ МНОГОФУНКЦИОНАЛЬНОЙ ОТРЕЗНОЙ МАШИНЫ TPW500K  
 • HARTMETALL-SÄGEBLATTSATZ FÜR MULTIFUNKTIONSTRENN-SÄGE TPW500K



• 3 pcs. • 54.8 x 11.1 mm

Code		
EATPW02	x	100

**6 SET OF CUTTING SAWS FOR MULTI-FUNCTION SAW TPW600K**  
 • НАБОР ОТРЕЗНЫХ ДИСКОВ ИЗ БЫСТРОРЕЖУЩЕЙ СТАЛИ ДЛЯ МНОГОФУНКЦИОНАЛЬНОЙ ОТРЕЗНОЙ МАШИНЫ TPW600K  
 • HSHSS-SÄGEBLATTSATZ FÜR MULTIFUNKTIONSTRENN-SÄGE TPW600K



• 3 pcs. • 89 x 10 mm • Suits Dexter tools

Code		
EATPW05	x	50

**7 RACK FOR MULTI-FUNCTION SAW TPW600K**  
 • РЕЙКА НАПРАВЛЯЮЩАЯ ДЛЯ МНОГОФУНКЦИОНАЛЬНОЙ ОТРЕЗНОЙ МАШИНЫ TPW600K • FÜHRUNGSLEISTE FÜR MULTIFUNKTIONSTRENN-SÄGE TPW600K

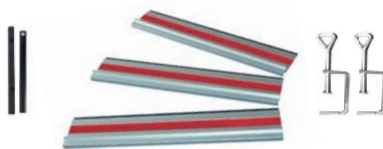

• Full length 126 mm (3 x 42 mm), 2 fittings, 2 clamps

Code		
EATPW09	x	10

**8 MITER-BASE FOR MULTI-FUNCTION SAW TPW600K**  
 • УГЛОВАЯ НАПРАВЛЯЮЩАЯ ДЛЯ МНОГОФУНКЦИОНАЛЬНОЙ ОТРЕЗНОЙ МАШИНЫ TPW600K



• 415 mm

Code		
EATPW10	x	10

**9 SET OF DIAMOND DISCS FOR MULTI-FUNCTION SAW TPW500K**  
 • НАБОР АЛМАЗНЫХ ДИСКОВ ДЛЯ МНОГОФУНКЦИОНАЛЬНОЙ ОТРЕЗНОЙ МАШИНЫ TPW500K • DIAMENTSÄGEBLATTSATZ FÜR MULTIFUNKTIONSTRENN-SÄGE TPW500K



• 3 pcs. • 54.8 x 11.1 mm

Code		
EATPW03	x	100

**10 SET OF CUTTING SAWS FOR MULTI-FUNCTION SAW TPW600K**  
 • НАБОР ОТРЕЗНЫХ ДИСКОВ ИЗ ТВЕРДЫХ СПЛАВОВ ДЛЯ МНОГОФУНКЦИОНАЛЬНОЙ ОТРЕЗНОЙ МАШИНЫ TPW600K  
 • HARTMETALL-SÄGEBLATTSATZ FÜR MULTIFUNKTIONSTRENN-SÄGE TPW600KI



• 3 pcs. • 89 x 10 mm • Suits Dexter tools

Code		
EATPW06	x	50

**11 BLADE FOR BISCUIT JOINER TFR900K**  
 • ФРЕЗА ДЛЯ СТАНКА ДЛЯ ФРЕЗЕРОВАНИЯ ПАЗОВ TFR900K  
 • FRÄSER FÜR NUTFÄSE TFR900K



• 100 x 22 x 4 mm • Suits Bass, Bosh, DeWalt, Einhell, Erbauer, Fern, Makita, Meec, Meister, Virutex tools

Code		
EATFR01	x	100

**12 BISCUITS FOR BISCUIT JOINER TFR900K**  
 • КОМПЛЕКТ ЛАМЕЛЛЕЙ ДЛЯ СТАНКА ДЛЯ ФРЕЗЕРОВАНИЯ ПАЗОВ TFR900K • LAMELLENSETZ FÜR NUTFÄSE TFR900K



• 60 pcs. (20 x #0, 20 x #10, 20x #20)

Code		
EATFR02	x	50

**1 TRIMMING HEAD**

• РЕЖУЩАЯ ГОЛОВКА • TRIMMERKOPF

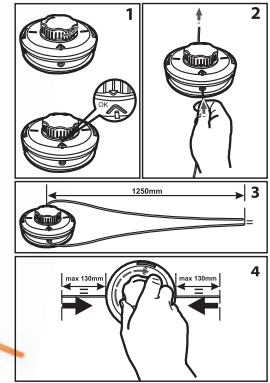

Reinforced construction that fits most cutter/trimmer models on the market • Easy-Load system - string replacement without the need to disassemble the head • Automatic string extension during "Tap&Go" operation

Code	<b>EATOP01</b>
mounting	left thread M10 x 1,25
String diameter	from 1,5 mm to 3,0 mm
starting string	round Ø 2,7 mm (2,5 m)
carton quantities	20 / 40

**2 PETROL TRIMMER BLADES**

• РЕЖУЩИЕ НОЖИ ДЛЯ БЕНЗИНОВЫХ КОСИЛОК • BENZIN-TRIMMER-KLINGEN



YTOP25N1



YTOP25N2



YTOP25N3

• Adapted to fit the TRYTON TOP252S and TOP431S hedge trimmers and other models available on the market with a standard 25.4mm mounting

Code	Tooth quantity	
YTOP25N1	3	1
YTOP25N2	2	1
YTOP25N3	40	1

**3 PETROL TRIMMER AIR FILTER**

• ВОЗДУШНЫЕ ФИЛЬТРЫ ДЛЯ БЕНЗИНОВЫХ КОСИЛОК • BENZIN-TRIMMER-LUFTFILTER



YTOP25FL



YTOP43FL

Code	Trimmer model	
YTOP25FL	TOP252S	1
YTOP43FL	TOP431S	1

**4 PETROL TRIMMER SPARK PLUGS**

• СВЕЧИ ДЛЯ БЕНЗИНОВЫХ КОСИЛОК • BENZIN-TRIMMER-ZÜNDKERZEN



YTOPSZ01



YTOP43SW

Code	Trimmer model	
YTOPSZ01	TOP252S	1
YTOP43SW	TOP431S	1

**5 PETROL TRIMMER HARNESS**

• РЕМНИ ДЛЯ БЕНЗИНОВЫХ КОСИЛОК • BENZIN-TRIMMER-GURT



YTOP25S1



YTOP25S2

• Pasują do kos spalinowych TRYTON TOP252S i TOP431S oraz innych modeli dostępnych na rynku

Code	Type	
YTOP25S1	2-arm braces	1
YTOP25S2	1-arm belt	1

**6 CHAINSAW GUIDE BAR**

• НАПРАВЛЯЮЩИЕ ШИНЫ ДЛЯ ЦЕПНЫХ ПИЛ • KETTENSÄGEN-FÜHRUNGSSCHIENE



Code	Length (cm)	Chainsaw model	
YTOR02PW	45	TOR4945S, TOR45231	1
YTOR03PW	50	TOR50291	1
YTOR4163	40	TOR201P	1
YTOR5194	45	TOR241P	1
YTOC0391	40	TOC40203	1

**7 CHAINSAW CHAINS**

• ЦЕПИ ДЛЯ ЦЕПНЫХ ПИЛ • KETTENSÄGEKETTEN



Code	Chainsaw model	
SNNTOR45	TOR4945S, TOR45231	1
SNNTOR50	TOR50291	1
YTOR4162	TOR201P	1
YTOR5193	TOR241P	1
YTOC0392	TOC40203	1

**1 CHAINSAW AIR FILTERS**

• ВОЗДУШНЫЕ ФИЛЬТРЫ ДЛЯ ЦЕПНЫХ ПИЛ • KETTENSÄGEN-LUFTFILTER



YTOR5067



YTOR02FL



YTOR03FL



YTOR4004



YTOR5067

Code	Chainsaw model	
YTOR5067	TOR4945S	1
YTOR02FL	TOR45231	1
YTOR03FL	TOR50291	1
YTOR4004	TOR201P	1
YTOR5067	TOR241P	1



**2 CHAINSAW SPARK PLUGS**

• СВЕЧИ ЗАЖИГАНИЯ ДЛЯ ЦЕПНЫХ ПИЛ • KETTENSÄGEN-ZÜNDKERZEN



Code	Chainsaw model	
YTOR02SW	TOR4945S, TOR45231, TOR50291	1
YTOR4038	TOR201P, TOR241P	1

**3 BLADES FOR HEDGE TRIMMERS**

• РЕЖУЩИЕ НОЖИ ДЛЯ НОЖИЦ ДЛЯ ЖИВОЙ ИЗГОРОДИ  
• KLINGEN FÜR HECKENSCHNEIDER



Code	Trimmer model	
YTOD0304	TOD51501	1
YTOD0305	TOD51501	1
YTOD0206	TOD61621	1
YTOD0207	TOD61621	1

**4 BLADES FOR LAWN MOWERS**

• РЕЖУЩИЕ НОЖИ ДЛЯ ГАЗОНОКОСИЛОК  
• KLINGEN FÜR RASENMÄHER



Code	Length (cm)	Washer model	
YTOK0866	46	TOK4632C, TOK4633C, TOK4642B	1
YTOK0558	51	TOK5152B	1
YTOK0732	53	TOK5362B, TOK5362	1
YTOA0330	32	TOA32122	1
YTOA0430	38	TOA38141	1

**5 AIR FILTERS FOR PETROL LAWN MOWERS**

• ВОЗДУШНЫЕ ФИЛЬТРЫ ДЛЯ БЕНЗИНОВЫХ ГАЗОНОКОСИЛОК  
• LUFTFILTER FÜR BENZINRASENMÄHER



Code	Mower model	
YZ1E0905	TOK4632C, TOK4633C	1
YBS750FP	TOK5362B, TOK5362	1

PROLINE

LANTI PRO

MEGA

JUCO

OTHER BRANDS

ERDI

KLINGSPOR

EXPRESS

ACTION CAN

TRYTON

VULCAN

**1 SPARK PLUGS FOR PETROL LAWN MOWERS**

- СВЕЧИ ЗАЖИГАНИЯ ДЛЯ ГАЗОНОВЫХ БЕНЗОКОСИЛОК
- ZÜNDKERZEN FÜR BENZIN-RASENMÄHER



Code	Mower model	
YZ1E0106	TOK4632C, TOK4633C	1
SNT013	TOK4642B, TOK5152B, TOK5362B, TOK53621	1

**2 NOZZLES FOR PRESSURE WASHERS**

- ПИСТОЛЕТЫ ДЛЯ МОЕК ВЫСОКОГО ДАВЛЕНИЯ
- DÜSEN FÜR DRUCKREINIGER



Code	Washer model	
EATM01	TM16105, TM18135, TM18165	1
EAVM01	VM1650	1

**3 EXTENSIONS FOR PRESSURE WASHERS**

- УДЛИНИТЕЛИ ДЛЯ МОЕК ВЫСОКОГО ДАВЛЕНИЯ
- DÜSEN FÜR DRUCKREINIGER



Code	Washer model	
EATM02	TM16105, TM18135, TM18165	1
EAVM02	VM1650	1

**4 LANCES FOR PRESSURE WASHERS**

- ШТАНГИ ДЛЯ МОЕК ВЫСОКОГО ДАВЛЕНИЯ
- DÜSEN FÜR DRUCKREINIGER



EATM03



EATM04



EAVM03



EAVM04

Code	Typee	Washer model	
EATM03	1 fan	TM16105, TM18135, TM18165	1
EATM04	1 rotary	TM16105, TM18135, TM18165	1
EAVM03	1 fan	VM1650	1
EAVM08	8-rotary	VM1650	1

**5 HOSES FOR PRESSURE WASHERS**

- ШЛАНГИ ДЛЯ МОЕК ВЫСОКОГО ДАВЛЕНИЯ
- SCHLÄUCHE FÜR DRUCKREINIGER



Code	Length (m)	Washer model	
EATM06	5	TM16105, TM18135, TM18165	1
EAVM04	5	VM1650	1

**6 BRUSHES FOR PRESSURE WASHERS**

- ЩЕТКИ ДЛЯ МОЕК ВЫСОКОГО ДАВЛЕНИЯ
- BÜRSTEN FÜR DRUCKREINIGER



EAVM06



EAVM07

Code	Typee	Washer model	
EAVM06	gerade	TM16105, TM18135, TM18165, VM1650	1
EAVM07	rotary	TM16105, TM18135, TM18165, VM1650	1

**7 TERRACE WASHING ATTACHMENT FOR PRESSURE WASHERS**

- НАСАДКА ДЛЯ МЫТЬЯ ТЕРРАС ДЛЯ МОЕК ВЫСОКОГО ДАВЛЕНИЯ
- TERRASSEN-WASCH-AUFSATZ



Code	Washer model	
EATM05	TM16105, TM18135, TM18165, VM1650	1

**8 DETERGENT CONTAINER FOR PRESSURE WASHERS**

- ЕМКОСТЬ ДЛЯ МОЮЩЕГО СРЕДСТВА ДЛЯ МОЕК ВЫСОКОГО ДАВЛЕНИЯ
- WASCHMITTELBEHÄLTER



Code	Washer model	
EAVM05	VM1650	1

# VULCAN concept



# V

ulcan Concept is a range of amateur power tools, i.e. tools primarily intended for DIYers and hobbyists. People who want to do repairs and upgrades by themselves in their free time.

Vulcan Concept machines are designed and use components that allow great usability. Vulcan Concept Power Tools offer all the functionality of professional machines, but are not recommended for commercial work. They can cope with them, but the components used will wear out faster.

Consumers often choose Vulcan Concept solutions and they have a great reputation on the market. All machines come with professional warranty and post-warranty services. The brand's owner ensures permanent access to consumables and spare parts.

Vulcan Concept is a sensible investment in equipment for every workshop.

Vulcan Concept - это линия электроинструментов любительского класса, предназначенных прежде всего для тех, кто любит помастерить на уровне хобби. Для людей, которые в свободное время хотят самостоятельно выполнять ремонты и модернизации.

Конструкция устройств Vulcan Concept, как и использованные в них подузлы, позволяют получать удовольствие от их высокой и разнообразной функциональности. Устройства Power Tools Vulcan Concept имеют все удобные приспособления, используемые в машинах профессионального класса, однако, они не рекомендуются к использованию в коммерческих работах. Могут их выполнять, но используемые подузлы в этом случае быстрее изнашиваются.

Решения Vulcan Concept очень охотно выбирает потребитель и они пользуются на рынке большим успехом. Все машины обеспечены профессиональным гарантийным и послегарантийным сервисным обслуживанием. Владелец марки гарантирует постоянный доступ к эксплуатационным и запчастям.

Vulcan Concept - это разумная инвестиция в эквипмент любой мастерской.

Bei Vulcan Concept handelt es sich um eine Reihe von Amateur-Elektrowerkzeugen, d. h. Maschinen, die hauptsächlich für Heimwerker und Bastler gedacht sind. Menschen, die in ihrer Freizeit gerne selbständig reparieren und modernisieren wollen.

Das Design der Vulcan Concept Maschinen und die verwendeten Komponenten ermöglichen eine hohe Benutzerfreundlichkeit. Die Vulcan Concept Power Tools verfügen über alle Einrichtungen, die in professionellen Maschinen verwendet werden. Sie werden jedoch nicht für gewerbliche Zwecke empfohlen. Sie können damit umgehen, aber die verwendeten Komponenten unterliegen einem schnelleren Verschleiß.

Vulcan Concept ist eine von den Verbrauchern sehr gerngesehene Lösung und genießt einen hervorragenden Ruf auf dem Markt. Alle Maschinen verfügen über einen professionellen Garantie- und Nachgarantie-Service. Der Markeninhaber gewährleistet den permanenten Zugriff auf Verbrauchsmaterialien und Ersatzteile.

Vulcan Concept ist eine sinnvolle Investition in die Ausstattung jeder Werkstatt.



## POWER TOOLS

angle grinders

circular saws

drills

hammer drills

heat guns

high pressure washers

jig saws

planers

pumps



**1 CORDLESS DRILLS**

• АККУМУЛЯТОРНЫЕ ДРЕЛИ-ШУРУПОВЕРТЫ • KABELLOSE BOHRER



- Keyless chuck • Metal gears • 21+1 positions of clutch

Code	<b>VZV12C/VZV18C</b>
battery voltage	12V/18V
battery capacity	1.3 Ah
chuck	0.8-10 mm
speeds	1
no-load speed	0-700/min.
max. torque	12/18 Nm
equipment	3-hour charger; battery Li-Ion 1.3 Ah
carton quantities	5

**3 DRILL**

• СЕТЕВАЯ ДРЕЛЬ-ШУРУПОВЕРТ • NETZSCHRAUBVONNER



- For DIY purposes • Orbital gear box provides smooth torque
- Ergonomic compact construction and light weight

Code	<b>VZU240</b>
input power	240 W
chuck	10 mm
speeds	1
no-load speed	0-800/min.
max. torque	22 Nm
max. bit diameter	6 mm
carton quantities	10

**2 CORDLESS DRILL**

• АККУМУЛЯТОРНАЯ ДРЕЛЬ-ШУРУПОВЕРТ • АККУ-BOHRERSCHRAUBER



- Keyless chuck • Metal gears
- 21+1 positions of clutch

Code	<b>VZV18C2</b>
battery voltage	18 V
battery capacity	1.3 Ah
chuck	0.8-10 mm
speeds	2
no-load speed	I bieg 0-400/min, II bieg 0-1500/min.
max. torque	25 Nm
equipment	3-hour charger; 2 batteries Li-Ion 1.3 Ah
carton quantities	5

**4 HAMMER DRILLS**

• ДРЕЛИ УДАРНЫЕ • SCHLAGBOHRMASCHINEN



- Ball bearings • Light and ergonomic design
- Forward/reverse • Key chuck 1.5-13mm

Code	<b>VZW501/VZW601</b>
input power	500 W/600 W
no-load speed	0-2900/0-3000/min.
max. drilling capacity in concrete	13 mm
max. drilling capacity in steel	10 mm
max. drilling capacity in wood	20 mm
carton quantities	10

PROLINE

LANIT PRO

MEGA

JUCO

OTHER BRANDS

ERDI

KLINGSPOR

EXPRESS

ACTION CAN

TRYTON

**VULCAN**



## 1 HAMMER DRILLS

• ДРЕЛИ УДАРНЫЕ • SCHLAGBOHRMASCHINEN



- Ball bearings • Light and ergonomic design
- Forward/reverse • Key chuck

Code	VZW711/VZW801
input power	710 W/800 W
no-load speed	0-2900/0-3000/min.
max. drilling capacity in concrete	13 mm
max. drilling capacity in steel	10 mm
max. drilling capacity in wood	20 mm
carton quantities	10

## 3 ROTARY HAMMER DRILL

• ПЕРФОРАТОР SDS-PLUS • SCHLAGBOHRHAMMER SDS-PLUS



- Dust-proof ball bearings • Hardened impact set and gears • Impact drilling • Drilling

Code	VZM700
input power	700 W
chuck	sds-plus
no-load speed	0-1600/min.
impact	1.8 J
impact rate	0-5625/min.
max. drilling capacity in concrete	18 mm
max. drilling capacity in steel	13 mm
max. drilling capacity in wood	20 mm
equipment	3 bits, tradycyjny uchwyt wiertarski z adapterem, additional handle, depth limiter, kufer transportowy
carton quantities	4

## 2 ROTARY HAMMER DRILL

• ПЕРФОРАТОР SDS-PLUS • SCHLAGBOHRHAMMER SDS-PLUS



- Dust-proof ball bearings • Hardened impact set and gears • Impact drilling • Drilling

Code	VZM650
input power	650 W
chuck	sds-plus
no-load speed	0-1600/min.
impact	1.8 J
impact rate	0-5625/min.
max. drilling capacity in concrete	18 mm
max. drilling capacity in steel	13 mm
max. drilling capacity in wood	20 mm
equipment	additional handle, depth limiter
carton quantities	5

## 4 ANGLE GRINDERS

• УГЛОВАЯ ШЛИФОВАЛЬНАЯ МАШИНА • WINKELSCHLEIFER



- Hardened gears • Ergonomic compact construction and light weight

Code	VZS125B
input power	630 W
disc diameter	125 mm
no-load speed	12 000/min.
spindle	M14
equipment	protective disc guard, fixing spanner, kołnierze mocujące tarczę
carton quantities	6

PROLINE  
LANTI PRO  
MEGA  
JUCO  
OTHER BRANDS  
ERDI  
KLINGSPOR  
EXPRESS  
ACTION CAN  
TRYTON  
VULCAN

**1 ANGLE GRINDER**

• УГЛОВАЯ ШЛИФОВАЛЬНАЯ МАШИНА • WINKELSCHLEIFER



- Light and ergonomic design
- Switch with increased dust resistance
- Hardened gears

Code	VZS125C
input power	710 W
disc diameter	125 mm
no-load speed	11 000/min.
spindle	M14
carton quantities	6

**3 ANGLE GRINDER**

• УГЛОВАЯ ШЛИФОВАЛЬНАЯ МАШИНА • WINKELSCHLEIFER



- Easy start
- Rotating handle
- Switch with increased dust resistance
- Hardened gears

Code	VZS230
input power	2350 W
disc diameter	230 mm
no-load speed	6000/min.
spindle	M14
carton quantities	2

**2 ANGLE GRINDER**

• УГЛОВАЯ ШЛИФОВАЛЬНАЯ МАШИНА • WINKELSCHLEIFER



- Adjustable rotation speed
- Light and ergonomic design
- Switch with increased dust resistance
- Hardened gears

Code	VZS125D
input power	1010 W
disc diameter	125 mm
no-load speed	4 000-11 000/min.
spindle	M14
carton quantities	6

**4 HEAT GUN**

• ПИСТОЛЕТ ГОРЯЧЕГО ВОЗДУХА • HEISSLUFTGEBLÄSE FÜR LACKE



- 2 speeds
- For removing paint coatings, forming and welding plastics, shrinking shrink films, softening glue and defrosting water pipes

Code	VML20068
input power	2000 W
working temperature	400/600°C
air flow	350/500 l/min.
carton quantities	8

## 1 FINISHING SANDER

• ПЛОСКОШЛИФОВАЛЬНАЯ МАШИНА • SCHWINGSCHLEIFER



230V  
-50Hz



Code	VZO180
input power	180 W
pad size	90 x 187 mm
no-load speed	12000/min.
orbital speed	24000/min.
paper mounting	clamps
equipment	two abrasive sheets (80, 120), dust bag
carton quantities	10



## 2 ELECTRIC PLANER

• РУБАНОК ЭЛЕКТРИЧЕСКИЙ • ELEKTROHOBEL



230V  
-50Hz



• Rebating function • Accurate planing depth regulation

Code	VMG601
input power	600 W
no-load speed	16000/min.
max. planing depth	2 mm
planing width	82 mm
equipment	double sided blades, parallel guide ruler, rebating depth guide, dust extractor adapter
carton quantities	6

## 3 JIG SAW

• ЛОБЗИК ЭЛЕКТРИЧЕСКИЙ • SCHWEIFSAĞE



230V  
-50Hz



• Universal quick clamp

Code	VZR402
input power	400 W
rates / min.	3300/min.
max. cutting depth in wood/aluminum/steel	55/6/6 mm
carton quantities	10

**1 CIRCULAR SAW**

• ЦИРКУЛЯРНАЯ ПИЛА • KREISSÄGE



Code	<b>VZP1300</b>
input power	1300 W
disc diameter	160 mm
blade hole diameter	20 mm
no-load speed	4700/min.
max. cutting depth	55 mm
equipment	disc saw with 18 sintered carbide teeth, parallel guide ruler
carton quantities	4

**2 CIRCULAR SAW**

• ЦИРКУЛЯРНАЯ ПИЛА • KREISSÄGE



- Laser cut line guide

Code	<b>VZP1500</b>
input power	1500 W
disc diameter	185 mm
blade hole diameter	20 mm
no-load speed	4700/min.
max. cutting depth	65 mm
equipment	disc saw with 24 sintered carbide teeth, parallel guide ruler
carton quantities	4

**3 MITRE SAW**

• УГЛОТРОЦОВОЧНАЯ ПИЛА • KIRPSÄGE



- Aluminium base

Code	<b>VU1400</b>
input power	1400 W
disc diameter	210 mm
blade hole diameter	30 mm
no-load speed	5000/min.
cutting range [0°/0°]	50x120 mm
cutting range [0°/45°]	50x80 mm
cutting range [45°/0°]	30x120 mm
cutting range [45°/45°]	30x80 mm
equipment	disc saw with 24 sintered carbide teeth, material clamp, dust bag, side supports, keys
carton quantities	1

**4 TILE SAW**

• ПЛИТКОРЕЗ ЭЛЕКТРИЧЕСКИЙ, НАСТОЛЬНЫЙ • FLIESENSÄGE



- Dust protection • Large cutting range and high mobility

Code	<b>VG18601</b>
input power	600 W
disc diameter	180 mm
blade hole diameter	22.2 mm
no-load speed	2950/min.
max. cutting depth for 90 degree	35 mm
max. cutting depth for 45 degree	20 mm
length of cut material	360 mm
equipment	diamond disc, parallel guide ruler, angle guide ruler, fixing spanner
carton quantities	1

## 1 BENCH GRINDERS

• КОМБИНИРОВАННЫЕ ШЛИФОВАЛЬНЫЕ СТАНКИ • TISCHSCHLEIFER



230V  
-50Hz

- Dust-proof switch and bearings • Rough and finishing grinding discs

Code	VS121301/VS152001
input power	150 W/200 W
abrasive disc diameter	125 mm/150 mm
disc hole diameter	12.7 mm
abrasive disc thickness	16 mm
no-load speed	2950/min.
equipment	tarcza ścierna z drobnym ziarnem, tarcza ścierna z grubym ziarnem, protective shields, supports
carton quantities	1

## 3 SUBMERSIBLE PUMP FOR DIRTY WATER

• ПОГРУЖНОЙ НАСОС ДЛЯ ГРЯЗНОЙ ВОДЫ • TAUCHPUMPE MIT SCHWIMMSCHALTER



230V  
-50Hz

10 m

- Wyłącznik pływakowy

Code	VPB750
input power	750 W
max depth	7 m
max. ponor	9 m
input powermost	13000 l/h
weight	5.4 kg
carton quantities	4

## 2 SUBMERSIBLE PUMP FOR DIRTY WATER

• ПОГРУЖНОЙ НАСОС ДЛЯ ГРЯЗНОЙ ВОДЫ • TAUCHPUMPE MIT SCHWIMMSCHALTER



230V  
-50Hz

10 m

- Float switch

Code	VPB400
input power	400 W
max depth	5 m
max. ponor	5 m
input powermost	7500 l/h
weight	4.3 kg
carton quantities	4

## 4 HIGH PRESSURE WASHER

• МОЙКА ВЫСОКОГО ДАВЛЕНИЯ • HOCHDRUCKREINIGER



230V  
-50Hz

5 m

- Aluminum pump • Light weight • Auto-STOP function

Code	VM1650
input power	1650 W
maximum pressure	10.5 Mpa
max. input powermost	5.7 l/min.
water temperature	5° - 50°
weight	6.5 kg
equipment	spray gun, fan lance with flow regulation, lance extension, cleaning agent container, 5 meter pressure hose
carton quantities	1

# INDEX

Product code index

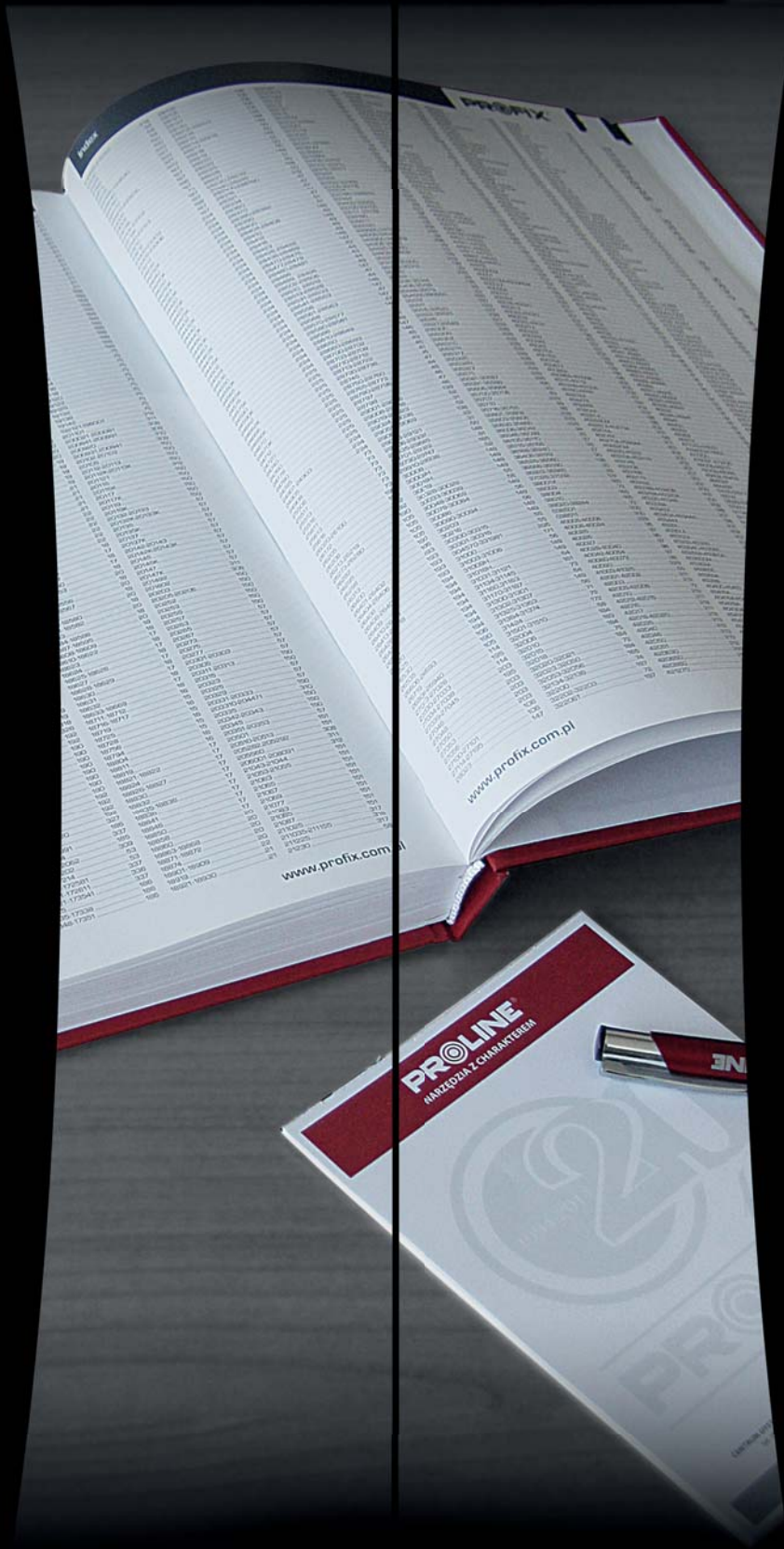

00105.....	517	12291.....	553	12836.....	167	15430.....	141	18557.....	48
00107.....	517	12297.....	510	12840.....	167	15520.....	141	18568.....	53
00301.....	517	12298.....	512	12843.....	167	15525.....	141	18572.....	51
00306.....	519	12299.....	510	12846.....	167	15530.....	141	18575.....	48
00323.....	519	12300.....	510	12854.....	167	15540.....	141	18576.....	52
00325.....	518	12306.....	510	12866.....	168	15615.....	141	18578.....	52
00341.....	518	12307.....	510	12868.....	168	15620.....	141	18579.....	52
01401.....	524	12308.....	510	12870.....	168	15625.....	141	18580.....	52
01430.....	530	12309.....	510	12872.....	168	15630.....	141	18581.....	52
01519.....	528	12310.....	510	12876.....	168	15640.....	141	18582.....	53
01520.....	528	12312.....	510	12916.....	538	15720.....	141	18583.....	48
01618.....	524	12313.....	510	12932.....	537	15721.....	141	18599.....	50
01621.....	524	12314.....	510	12933.....	538	15725.....	141	18623.....	48
01645.....	540	12315.....	510	12944.....	538	15726.....	141	18624.....	47
07905.....	216	12318.....	510	12945.....	538	15730.....	141	18627.....	47
07908.....	216	12319.....	510	12946.....	538	15731.....	141	18630.....	47
10000.....	477	12320.....	510	12950.....	538	15804.....	139	18631.....	48
10007.....	477	12321.....	510	12955.....	538	15806.....	139	18632.....	47
10008.....	103	12323.....	510	12958.....	538	15808.....	139	18669.....	49
10016.....	103	12324.....	510	12970.....	537	15810.....	139	18696.....	52
10022.....	102	12325.....	510	12971.....	538	15812.....	139	18711.....	46
10028.....	103	12326.....	510	13110.....	531	15815.....	139	18712.....	46
10055.....	478	12327.....	512	13113.....	531	15820.....	139	18719.....	41
10100.....	104	12332.....	534	13114.....	531	15920.....	527	18804.....	46
10106.....	104	12333, 12334.....	535	13116.....	531	15940.....	141	18811.....	46
10112.....	104	12335.....	533	13118.....	531	16525.....	494	18819.....	47
10158.....	104	12340.....	510	13119.....	531	16528.....	494	18824.....	47
10206.....	477	12342.....	535	13121.....	484	16716.....	540	18830.....	47
10211.....	104	12354.....	535	13123.....	484	16718.....	540	18832.....	47
10221.....	477	12355, 12356.....	512	13126.....	484	16720.....	540	18838.....	47
10228.....	101	12358.....	512	13129.....	484	16735.....	540	18841.....	47
10229.....	106	12363.....	535	13136.....	532	16740.....	540	18846.....	47
10510.....	106	12364.....	536	13138.....	532	17001.....	490	18850.....	47
10511.....	106	12367.....	535	13151.....	532	17045.....	490	18858.....	53
10583.....	478	12370.....	537	13163.....	532	17060.....	490	18860.....	52
10584.....	515	12373.....	167	13165.....	532	17075.....	490	18863.....	53
10587.....	515	12379.....	167	13167.....	532	17104.....	507	18864.....	52
10590.....	515	12389.....	551	13171.....	532	17210.....	119	18865.....	52
10601.....	99	12391.....	167	13600.....	508	17211.....	118	18874.....	53
10602.....	99	12405.....	509	13620.....	508	17214.....	118	18906.....	55
10618.....	96	12407.....	509	13723.....	508	17325.....	556	18907.....	55
10697.....	103	12410.....	509	13725.....	508	17414.....	172	18919.....	54
10740.....	475	12415.....	509	14001.....	497	17418.....	172	18938.....	54
10741.....	100	12420.....	509	14002.....	498	17424.....	172	18946.....	54
10743.....	100	12425.....	509	14005.....	498	17430.....	172	18948.....	54
10744.....	101	12427.....	509	15000.....	483	17436.....	172	18950.....	54
10900.....	99	12429.....	509	15034.....	482	17442.....	172	18952.....	54
10937.....	105	12430.....	509	15036.....	482	18001, 18002.....	486	18955.....	54
10950.....	475	12435.....	509	15038.....	482	18012.....	486	18960.....	54
10959.....	475	12439.....	509	15040.....	482	18017.....	162	18969.....	54
10970.....	475	12440.....	509	15042.....	482	18018.....	486	18988.....	54
10980.....	475	12450.....	509	15045.....	482	18125.....	53	18996.....	54
10998.....	477	12460.....	509	15050.....	482	18160.....	53	19004.....	492
10999.....	476	12476.....	509	15054.....	141	18161.....	53	19006.....	492
11010.....	492	12478.....	509	15056.....	141	18162.....	53	19008.....	492
11015.....	492	12479.....	509	15058.....	141	18163.....	47	19010.....	492
11020.....	492	12480.....	509	15060.....	141	18164.....	52	19012.....	492
11025.....	492	12508.....	145	15062.....	141	18169.....	47	19018.....	492
11030.....	492	12510.....	145	15065.....	141	18171.....	53	19020.....	492
11031.....	492	12518.....	145	15070.....	141	18172.....	51	19022.....	492
11051.....	492	12561.....	146	15076.....	141	18175.....	52	19025.....	492
11081.....	492	12565.....	146	15078.....	141	18176.....	47	19032.....	492
11101.....	492	12572.....	146	15080.....	141	18178.....	52	19038.....	492
11121.....	492	12585.....	145	15082.....	141	18179.....	47	19106.....	175
11215.....	163	12608.....	145	15085.....	141	18180.....	52	19108.....	175
11251.....	163	12610.....	145	15090.....	141	18196.....	52	19110.....	175
11420.....	163	12615.....	145	15100.....	483	18199.....	50	19112.....	175
11430.....	163	12620.....	145	15102.....	483	18324.....	47	19114.....	175
11440.....	163	12670.....	147	15124.....	483	18345.....	53	19116.....	175
11450.....	163	12706.....	168	15142.....	484	18350.....	53	19118.....	175
11460.....	163	12708.....	168	15145.....	483	18352.....	53	19120.....	175
11515.....	163	12710.....	168	15150.....	483	18354.....	52	19122.....	175
11525.....	163	12712.....	168	15166.....	138	18367.....	47	19125.....	175
11530.....	163	12716.....	168	15170.....	142	18368.....	53	19132.....	175
11531.....	163	12726.....	167	15175.....	143	18369.....	47	19138.....	175
11550.....	163	12728.....	167	15176.....	482	18372.....	51	19142.....	175
12010.....	487	12734.....	167	15178.....	482	18375.....	52	20101.....	482
12035.....	487	12736.....	167	15180.....	482	18378.....	52	20105.....	481
12128.....	487	12745.....	554	15182.....	482	18396.....	52	20115.....	481
12192.....	536	12748.....	554	15185.....	482	18399.....	50	20117.....	481
12200.....	487	12766.....	554	15190.....	482	18431.....	55	20119.....	481
12204.....	487	12768.....	554	15194.....	140	18432.....	54	20123.....	137
12206.....	487	12770.....	554	15234.....	140	18461.....	55	20125.....	137
12207.....	509	12772.....	554	15236.....	140	18462.....	54	20128.....	137
12212, 12213.....	487	12775.....	554	15238.....	140	18477.....	55	20135.....	137
12214.....	510	12781.....	554	15240.....	140	18478.....	55	20137.....	137
12220.....	145	12783.....	554	15242.....	140	18484.....	55	20145.....	137
12250, 12251.....	552	12785.....	554	15245.....	140	18489.....	55	20147.....	137
12252.....	551	12796.....	554	15300.....	142	18490.....	56	20203.....	481
12266.....	533	12798.....	554	15396.....	142	18491.....	55	20283.....	136
12273.....	535	12803.....	168	15398.....	142	18526.....	48	20285.....	136
12275.....	534	12806.....	168	15410.....	141	18531.....	48	20288.....	136
12276.....	551	12808.....	168	15412.....	141	18532.....	47	20293.....	137
12278.....	551	12810.....	168	15415.....	141	18550.....	48	20295.....	137
12279.....	552	12812.....	168	15418.....	141	18554.....	48	20298.....	137
12281, 12282.....	552	12816.....	168	15420.....	141	18555.....	53	20305.....	137
12286.....	553	12825.....	168	15424.....	141	18556.....	53	20315.....	481

20323.....	137	26616.....	236	28222.....	116	29312.....	115	32452.....	247
20325.....	137	26618.....	236	28225.....	479	29315.....	115	32457.....	247
20329.....	137	26620.....	236	28226.....	116	29318.....	115	32507.....	248
20335.....	481	26622.....	236	28227.....	115	29324.....	115	32510.....	248
20345.....	482	26628.....	236	28230.....	479	29326.....	115	32530.....	248
20363.....	137	26630.....	236	28232.....	479	29328.....	115	32532.....	248
20365.....	137	26632.....	236	28240.....	116	29330.....	115	32542.....	248
20368.....	137	26638.....	236	28245.....	116	29332.....	115	32545.....	248
20501.....	482	26640.....	236	28316.....	111	29635.....	516	32549.....	248
20515, 20516.....	138	26645.....	236	28321.....	111	29645.....	516	32555.....	248
20518.....	138	26691.....	236	28334.....	111	29655.....	516	32558.....	248
21063.....	516	26693.....	236	28360.....	111	29665.....	516	32576.....	248
21065.....	516	26719.....	492	28370.....	111	29701.....	117	32578.....	248
21067.....	516	26806.....	236	28390.....	116	30008.....	480	32580.....	248
21069.....	516	26808.....	236	28400.....	479	30019.....	480	32603.....	176
21077.....	516	26810.....	236	28404.....	114	30030.....	134	32805.....	248
21083.....	516	26812.....	236	28408.....	114	30033.....	134	32807.....	248
21085.....	516	26814.....	236	28410.....	479	30040.....	134	32810.....	248
21087.....	516	26816.....	236	28412.....	114	30048.....	480	32812.....	248
21125.....	482	26818.....	236	28416.....	114	30050.....	135	32815.....	248
21130.....	482	26820.....	236	28426.....	479	30058.....	480	32827.....	248
21135.....	482	26822.....	236	28428.....	479	30060.....	135	32830.....	248
21210.....	139	26828.....	236	28436.....	478	30078.....	133	32845.....	247
21220.....	139	26830.....	236	28438.....	478	30079.....	134	32847.....	247
21230.....	138	26835.....	236	28446.....	478	30082.....	134	32907.....	248
21330.....	138	26840.....	236	28448.....	478	30084.....	134	32910.....	248
21335.....	138	26910.....	236	28456.....	478	30086.....	481	32915.....	247
21350.....	138	26912.....	236	28458.....	478	30090.....	134	32917.....	247
22015.....	482	26914.....	236	28466.....	478	30203.....	480	32922.....	174
22030.....	482	26916.....	236	28468.....	478	30216.....	481	32924.....	247
23000.....	491	26918.....	236	28473.....	107	30305.....	133	32932.....	174
23005.....	490	26920.....	236	28475.....	107	30307.....	133	32942.....	174
23102.....	490	26922.....	236	28477.....	108	30315.....	133	32962.....	174
23103.....	507	26924.....	236	28479.....	108	31000.....	480	33107.....	35
23123.....	165	26925.....	236	28486.....	108	31031.....	149	33113.....	31
23210.....	540	26926.....	236	28506.....	506	31041.....	149	33114.....	30
23212.....	540	26928.....	236	28510.....	111	31051.....	149	33115.....	32
23300.....	491	26930.....	236	28512.....	111	31061.....	149	33119.....	29
23313.....	540	26935.....	236	28513.....	108	31081.....	149	33127.....	34
24232.....	500	26940.....	236	28515.....	108	31101.....	149	33128.....	27
24240.....	500	27026.....	268	28516.....	108	31121.....	149	33129.....	26
24250.....	500	27034.....	268	28518.....	108	31134.....	484	33130.....	25
24261.....	178	27046.....	541	28526.....	108	31136.....	484	33131.....	28
24263.....	500	27048.....	543	28528.....	108	31138.....	484	33204.....	36
24271.....	178	27050.....	543	28551.....	506	31140.....	484	33205.....	36
24281.....	178	27053.....	543	28553.....	506	31143.....	484	33403.....	196
24291.....	178	27056.....	543	28556.....	111	31145.....	484	33405.....	196
24432.....	500	27114.....	237	28568.....	111	31160.....	170	33553.....	196
24440.....	500	27116.....	237	28575.....	506	31163.....	170	33555.....	196
24450.....	500	27122.....	237	28577.....	505	31307.....	135	33711.....	496
24463.....	500	27124.....	237	28599.....	506	31325.....	169	33715.....	496
24475.....	500	27125.....	237	28610.....	113	31330.....	169	33723.....	496
24550.....	500	27127.....	237	28615.....	113	31350.....	169	33730.....	496
24565.....	500	27132.....	237	28617.....	113	31352.....	170	33732.....	496
24575.....	500	27135.....	237	28619.....	113	31353.....	169	34006.....	59
24590.....	500	27138.....	237	28620.....	113	31354.....	170	34016.....	59
24662.....	500	27140.....	237	28625.....	113	31355.....	169	34027.....	59
24666.....	500	27144.....	237	28627.....	113	31356.....	170	34030.....	59
24670.....	500	27146.....	237	28629.....	113	31358.....	169	34036.....	59
24712.....	501	27148.....	237	28630.....	113	31370.....	169	34038.....	59
24760.....	501	27151.....	237	28635.....	113	31380.....	103	34081.....	472
24778.....	501	27154.....	237	28637.....	113	31381.....	237	34103.....	472
24780.....	501	27157.....	237	28639.....	113	31382.....	170	34137.....	472
24785.....	501	27160.....	237	28640.....	113	31383.....	173	34179.....	472
24840.....	178	27164.....	237	28645.....	113	31384.....	102	34192.....	472
24850.....	178	27170.....	237	28647.....	113	31385.....	170	34247.....	472
24860.....	178	27173.....	237	28649.....	113	31392.....	170	34272.....	472
24905.....	500	27183.....	237	28650.....	479	31393.....	237	34282.....	472
24940.....	178	27192.....	237	28681.....	478	31394.....	103	34306.....	66
24950.....	178	27195.....	237	28683.....	478	31395.....	99	34327.....	66
24960.....	178	27200.....	238	28691.....	478	31398.....	236	34330.....	66
25325.....	490	27206.....	238	28693.....	478	31400.....	134	34406.....	67
25340.....	490	27208.....	238	28745.....	111	31424.....	488	34408.....	67
25360.....	490	27210.....	238	28760.....	108	31601, 31602.....	175	34412.....	67
25507.....	173	27212.....	238	28797.....	111	31611, 31612.....	175	34426.....	472
25510.....	173	27215.....	238	28798.....	110	31621, 31622.....	175	34428.....	472
25512.....	173	27220.....	238	29001.....	474	32004.....	489	34432.....	471
25515.....	173	27222.....	238	29003.....	474	32010.....	488	34436.....	471
25610.....	173	27225.....	238	29006.....	473	32015.....	175	34457.....	471
25612.....	173	27230.....	238	29008.....	117	32016.....	488	34460.....	471
25615.....	173	27235.....	238	29010.....	117	32018.....	489	34908.....	473
26172.....	541	27240.....	238	29012.....	117	32023.....	489	34910.....	473
26205.....	494	27251.....	238	29014.....	117	32044.....	526	34917.....	473
26208.....	494	27260.....	238	29018.....	117	32050.....	489	34919.....	473
26213.....	492	27268.....	238	29019.....	70	32058.....	537	34922.....	473
26219.....	492	28023.....	480	29022.....	70	32074.....	526	34924.....	473
26282.....	236	28102.....	237	29023.....	69	32200.....	496	35236.....	472
26295.....	236	28105.....	237	29024.....	117	32255.....	174	35277.....	471
26298.....	236	28121.....	237	29036.....	117	32265.....	174	35280.....	471
26313.....	492	28127.....	237	29051.....	472	32406.....	247	35282.....	471
26400.....	237	28140.....	237	29056.....	472	32408.....	247	35284.....	471
26406.....	494	28208, 28209.....	507	29080.....	73	32410.....	247	35286.....	471
26426.....	541	28210.....	479	29116.....	70	32426.....	247	35288.....	471
26434.....	495	28217.....	115	29121.....	70	32428.....	247	35291.....	471
26606.....	236	28218.....	479	29306.....	115	32430.....	247	35296.....	471
26608.....	236	28219.....	116	29308.....	115	32432.....	247	35300.....	471
26610.....	236	28220.....	115	29310.....	115	32447.....	247	35306.....	66



35308.....	66	36218.....	64	40039.....	214	46345.....	501	55212.....	497
35312.....	66	36220.....	64	40040.....	212	46346.....	501	55214.....	497
35324.....	66	36222.....	64	40042.....	213	46358.....	501	55306.....	182
35336.....	471	36224.....	64	40045.....	213	46361.....	501	55308.....	182
35338.....	471	36226.....	64	40050.....	213	46381.....	501	55310.....	182
35340.....	67	36228.....	64	40052.....	214	46411.....	216	55312.....	182
35342.....	471	36230.....	64	40054.....	214	46423.....	216	55314.....	182
35344.....	471	36234.....	64	40068.....	214	46435.....	216	55330.....	182
35378.....	58	36237.....	64	40090.....	503	46458.....	216	55332.....	182
35389.....	58	36240.....	64	40115.....	554	46461.....	216	55340.....	183
35427.....	66	36408.....	68	40118.....	554	46481.....	216	55342.....	183
35430.....	66	36410.....	68	40119.....	553	46710.....	84	55344.....	183
35432.....	66	36415.....	68	41180.....	159	46713.....	84	55406.....	182
35487.....	57	36417.....	68	41244.....	157	46715.....	84	55408.....	182
35497.....	57	36419.....	68	41247.....	157	46805.....	82	55410.....	182
35512.....	549	36428.....	68	41248.....	156	46808.....	82	55412.....	182
35513.....	550	36430.....	68	41249.....	158	46810.....	82	55414.....	182
35516.....	549	36432.....	68	41252.....	157	46812.....	82	55426.....	182
35519.....	549	36434.....	68	41253.....	156	46815.....	82	55428.....	182
35527.....	549	36439.....	68	41254.....	157	46820.....	82	55440.....	183
35529.....	550	36445.....	68	41259.....	157	46841, 46842.....	69	55442.....	183
35576.....	527	36455.....	68	41262.....	157	46847.....	73	55506.....	183
35578.....	527	36506.....	67	41263.....	156	46848.....	81	55508.....	183
35581.....	549	36508.....	67	41264.....	158	46849.....	79	55510.....	183
35583.....	549	36512.....	67	41267.....	157	46850.....	75	55512.....	183
35594.....	528	36526.....	472	41268.....	156	46851.....	76	55514.....	183
35596.....	528	36528.....	472	41269.....	157	46852.....	81	55516.....	183
35599.....	528	36532.....	472	42014.....	545	46853.....	80	55616.....	183
35632.....	59	36536.....	472	42040.....	545	46854.....	79	55619.....	183
35634.....	59	36538.....	472	42047.....	544	46861, 46862.....	71	55622.....	183
35636.....	59	36540.....	472	42304.....	178	46870, 46871.....	78	55625.....	183
35638.....	59	36542.....	472	42311.....	549	46874.....	76	55628.....	183
35641.....	59	36544.....	472	42313.....	549	46875.....	80	55632.....	183
35646.....	59	36546.....	472	42346.....	575	46879.....	76	55638.....	183
35650.....	59	36548.....	472	42356.....	576	46880, 46881.....	80	55640.....	183
35662.....	59	36554.....	472	42358.....	573	46886.....	76	55715.....	183
35664.....	59	36555.....	472	42359.....	576	46887.....	75	55720.....	183
35706.....	196	36560.....	472	42500.....	73	46888.....	79	55725.....	183
35707.....	551	36566.....	67	42505.....	486	46889.....	80	55730.....	183
35710.....	196	36568.....	67	42506, 42507.....	73	46892.....	77	55735.....	183
35711.....	551	36570.....	67	42911, 42912.....	188	46893.....	76	55740.....	183
35716.....	195	36572.....	67	43014.....	528	46894.....	76	55745.....	183
35718.....	195	36574.....	67	43029.....	528	46895.....	78	55750.....	183
35722.....	195	36576.....	67	43038.....	526	46926.....	82	58027.....	470
35725.....	195	36578.....	67	43176.....	530	46969.....	75	58046.....	468
35741.....	196	36590.....	67	43211.....	530	46979.....	74	58072.....	469
35748.....	195	36606.....	60	43214.....	527	46981, 46982.....	75	58075.....	469
35752.....	195	36608.....	60	43320.....	531	47010.....	494	58082.....	468
35755.....	195	36610.....	60	43326.....	531	48008.....	474	58085.....	470
35780.....	551	36612.....	60	43331.....	531	48010.....	474	58091.....	468
35830.....	550	36614.....	60	43339.....	531	48012.....	474	58094.....	468
35860.....	550	36616.....	60	43349.....	531	48018.....	474	58144.....	469
36006.....	60	36618.....	60	44018.....	265	48049.....	474	58217.....	45
36008.....	60	36630.....	60	44023.....	265	48110.....	474	58500.....	49
36010.....	60	36650.....	58	44030.....	265	48207.....	474	58701.....	40
36012.....	60	36680.....	62	44035.....	265	48210.....	474	58702.....	40
36014.....	60	36686.....	62	44040.....	265	48309.....	91	58703.....	39
36016.....	60	36690.....	62	44118.....	265	48310.....	92	58711.....	38
36018.....	60	36722.....	68	44123.....	265	48319.....	91	58717.....	46
36030.....	60	36742.....	473	44223.....	265	48320.....	92	58718.....	40
36046.....	61	36810.....	65	44323.....	497	48329.....	91	58722.....	40
36055.....	61	36922.....	65	44418.....	265	48330.....	92	58725.....	42
36059.....	61	36924.....	65	44423.....	265	48339.....	91	58733.....	39
36062.....	61	36927.....	65	44518.....	265	48340.....	92	58743.....	41
36068.....	61	36930.....	65	44523.....	265	48378.....	91	58761.....	40
36079.....	61	36932.....	65	44623.....	265	48388.....	91	58763.....	40
36090.....	62	36936.....	65	44905.....	497	48412.....	89	58765.....	39
36093.....	62	36938.....	65	44910.....	497	48414.....	89	58787.....	39
36097.....	62	36941.....	65	44915.....	495	48417.....	89	58793.....	40
36099.....	62	36946.....	65	45001.....	489	48419.....	89	58794.....	43
36105.....	63	36950.....	65	45043.....	566	48452.....	89	58795.....	38
36116.....	63	36955.....	65	45072.....	561	48454.....	89	58797.....	40
36120.....	63	36960.....	65	45079.....	561	48457.....	89	58825.....	42
36124.....	63	36965.....	65	45180, 45181.....	484	48459.....	89	58843.....	41
36128.....	63	38000.....	171	45345.....	566	48600.....	475	58856.....	42
36132.....	63	38003.....	170	45348.....	566	48794.....	43	59307.....	498
36136.....	62	38004.....	484	45351.....	566	51017.....	501	59310.....	498
36138.....	62	38010.....	484	45540.....	564	51019.....	87	59312.....	498
36140.....	62	38031, 38032.....	171	45555.....	565	51022.....	501	59399.....	498
36142.....	62	38033.....	171	45606.....	565	51024.....	502	59408.....	498
36144.....	62	38039.....	171	45646.....	566	52011.....	503	59410.....	498
36154.....	62	38041.....	171	45890.....	562	52012.....	199	59412.....	498
36160.....	62	38043.....	171	46002.....	338	52016.....	199	59416.....	498
36166.....	62	38049.....	171	46008.....	352	52020.....	199	59418.....	498
36168.....	64	38102.....	171	46017.....	343	52070.....	198	59499.....	498
36170.....	64	38112.....	171	46018.....	342	52300.....	399	59508.....	498
36177.....	64	38144.....	171	46023.....	342	52306.....	398	59510.....	498
36179.....	64	38202.....	171	46028.....	343	55014.....	497	59512.....	498
36182.....	64	38212.....	171	46032.....	338	55024.....	180	59514.....	498
36184.....	64	38244.....	171	46033.....	341	55028.....	180	59518.....	498
36187.....	64	40005, 40006.....	503	46035.....	341	55034.....	181	59523.....	498
36190.....	64	40008.....	211	46051.....	341	55040.....	181	59599.....	498
36192.....	64	40024.....	212	46058.....	352	55042.....	181	60011.....	546
36206.....	473	40025.....	213	46063.....	352	55050.....	181	60012.....	547
36210.....	473	40030.....	213	46311.....	501	55206.....	497	60018.....	547
36215.....	64	40031.....	212	46323.....	501	55208.....	497	60034.....	187
36216.....	64	40035.....	212	46335.....	501	55210.....	497	60037.....	187

60072.....	499	62141.....	197	71060.....	231	73708.....	230	77448.....	225
60074.....	499	62142.....	198	71080.....	231	74037.....	232	77455.....	225
60076.....	499	62146.....	197	71216.....	231	74057.....	232	77465.....	225
60080.....	499	62161.....	197	71221.....	231	74072.....	232	77470.....	225
60319.....	549	64000.....	491	71226.....	231	74092.....	232	77475.....	225
60324.....	187	64053.....	165	71230.....	231	75000.....	485	77480.....	225
60332.....	187	64061.....	165	71235.....	231	75010.....	532	77482.....	225
60351.....	549	64076.....	165	71240.....	231	75011.....	532	77485.....	225
60412.....	547	64132.....	165	71245.....	231	75012.....	532	77490.....	225
60432.....	547	64160.....	491	71260.....	231	75013.....	533	77495.....	225
60442.....	547	64340.....	164	71316.....	231	75030.....	485	77500.....	225
60862.....	525	64345.....	164	71326.....	231	75040.....	485	77502.....	225
60908.....	526	64350.....	164	71416.....	231	75340.....	151	77505.....	225
60910.....	526	64360.....	164	71421.....	231	75350.....	151	77520.....	225
60912.....	526	64365.....	164	71426.....	231	75360.....	151	77810.....	224
60914.....	526	64370.....	164	71430.....	231	75449.....	485	77815.....	224
60916.....	526	64400.....	164	71440.....	231	75460.....	485	77820.....	224
60918.....	526	64405.....	164	71445.....	231	75540.....	151	77825.....	224
60920.....	526	64420.....	164	71460.....	231	75550.....	151	77830.....	224
60950.....	526	64426.....	214	71616.....	231	75560.....	151	77832.....	224
60956.....	526	64430.....	214	71621.....	231	75722.....	485	77835.....	224
60958.....	526	64433.....	165	71626.....	231	75725.....	151	77840.....	224
60960.....	526	64440.....	164	71630.....	231	75770.....	532	77842.....	224
60978.....	526	64445.....	164	71634.....	232	75772.....	485	77845.....	224
61001.....	518	64450.....	164	71635.....	231	75850.....	151	77848.....	224
61003.....	518	64460.....	164	71640.....	231	75860.....	151	77850.....	224
61005.....	518	64465.....	164	71645.....	231	75870.....	151	77852.....	224
61007.....	518	64470.....	164	71654.....	232	75880.....	151	77855.....	224
61010.....	517	64560.....	164	71660.....	231	75900.....	151	77860.....	224
61017.....	517	64570.....	164	71680.....	231	76102.....	222	77865.....	224
61110.....	522	64740.....	164	71692.....	232	76105.....	222	77870.....	224
61201.....	518	64745.....	164	71821.....	231	76110.....	222	77875.....	224
61203.....	518	64750.....	164	71826.....	231	76115.....	222	77880.....	224
61304.....	532	64840.....	164	71834.....	232	76120.....	222	77885.....	224
61306.....	532	64845.....	164	71835.....	231	76125.....	222	77890.....	224
61313.....	518	64850.....	164	71840.....	231	76130.....	222	77895.....	224
61357.....	486	66158.....	87	71845.....	231	76135.....	222	77900.....	224
61375.....	486	66343.....	126	71854.....	232	76140.....	222	77905.....	224
61380.....	533	66349.....	125	71860.....	231	76145.....	222	77910.....	224
61510.....	148	66391, 66392.....	181	71892.....	232	76150.....	222	77915.....	224
61520.....	148	66510.....	71	72021.....	231	76155.....	222	77920.....	224
61530.....	148	66511.....	193	72026.....	231	76160.....	222	77925.....	224
61579.....	149	66514.....	193	72030.....	231	76165.....	222	77930.....	224
61589.....	149	66517.....	193	72040.....	231	76170.....	222	77990.....	224
61600.....	517	66519.....	193	72045.....	231	76175.....	222	78005.....	224
61602.....	517	66522.....	193	72060.....	231	76180.....	222	78008.....	224
61605.....	517	67000.....	489	72080.....	231	76185.....	222	78010.....	224
61607.....	517	67008.....	489	72232.....	232	76190.....	222	78015.....	224
61610.....	519	67010.....	489	72252.....	232	76195.....	222	78020.....	224
61620.....	519	67012.....	489	72272.....	232	76200.....	222	78022.....	224
61640.....	148	67028.....	177	72292.....	232	76219.....	222	78025.....	224
61644.....	148	67030.....	177	72432.....	232	76225.....	222	78035.....	224
61646.....	148	67032.....	177	72452.....	232	76410.....	226	78038.....	224
61650.....	519	67100.....	489	72532.....	232	76412.....	226	78045.....	224
61670.....	521	67108.....	489	72552.....	232	76414.....	226	78048.....	224
61672.....	521	67110.....	489	72572.....	232	76416.....	226	78055.....	224
61700.....	520	67112.....	489	72592.....	232	76418.....	226	78065.....	224
61704.....	520	67198.....	177	72652.....	232	76420.....	226	78070.....	224
61706.....	520	67205.....	489	72837.....	232	76610.....	226	78075.....	224
61708.....	520	67215.....	117	72857.....	232	76612.....	226	78085.....	224
61710.....	520	67221.....	177	72867.....	232	76614.....	226	78090.....	224
61711.....	522	67224.....	489	72892.....	232	76616.....	226	78095.....	224
61712.....	520	67232.....	177	73037.....	232	76618.....	226	78100.....	224
61713.....	519	67240.....	117	73057.....	232	76620.....	226	78102.....	224
61716.....	519	69118.....	538	73072.....	232	77005.....	223	78105.....	224
61717.....	522	69211.....	538	73092.....	232	77008.....	223	78110.....	224
61720.....	521	69213.....	538	73112.....	230	77102.....	223	78115.....	224
61722.....	521	69501.....	539	73206.....	230	77105.....	223	78120.....	224
61728.....	521	69601.....	539	73208.....	230	77110.....	223	78125.....	224
61733.....	521	69691.....	539	73210.....	230	77115.....	223	78130.....	224
61736.....	521	69901.....	539	73212.....	230	77120.....	223	78140.....	224
61740.....	522	69921.....	539	73214.....	230	77125.....	223	78150.....	224
61742.....	522	69941.....	539	73216.....	230	77130.....	223	78160.....	224
61748.....	522	70411.....	231	73237.....	232	77135.....	223	78180.....	224
61750.....	522	70416.....	231	73257.....	232	77140.....	223	78200.....	224
61754.....	522	70511.....	231	73272.....	232	77145.....	223	78219.....	224
61756.....	522	70516.....	231	73292.....	232	77150.....	223	78225.....	224
61758.....	522	70611.....	231	73306.....	230	77155.....	223	78410.....	225
61768.....	521	70616.....	231	73308.....	230	77160.....	223	78415.....	225
61773.....	521	70621.....	231	73310.....	230	77165.....	223	78420.....	225
61776.....	521	70626.....	231	73312.....	230	77170.....	223	78425.....	225
61778.....	521	70811.....	231	73408.....	230	77175.....	223	78435.....	225
61801.....	525	70816.....	231	73410.....	230	77180.....	223	78445.....	225
61804.....	149	70821.....	231	73412.....	230	77185.....	223	78448.....	225
61805.....	524	70826.....	231	73414.....	230	77190.....	223	78455.....	225
61806.....	149	70830.....	231	73416.....	230	77195.....	223	78465.....	225
61808.....	149	70835.....	231	73537.....	232	77200.....	223	78467.....	225
61810.....	149	70840.....	231	73557.....	232	77219.....	223	78475.....	225
61812.....	149	70845.....	231	73567.....	232	77225.....	223	78480.....	225
61815.....	149	71011.....	231	73572.....	232	77408.....	225	78485.....	225
61818.....	149	71016.....	231	73592.....	232	77410.....	225	78490.....	225
61822.....	149	71021.....	231	73608.....	230	77412.....	225	78495.....	225
61824.....	149	71026.....	231	73610.....	230	77415.....	225	78500.....	225
61832.....	149	71030.....	231	73612.....	230	77425.....	225	78502.....	225
61840.....	149	71035.....	231	73614.....	230	77435.....	225	78516.....	225
62100.....	198	71040.....	231	73703.....	230	77438.....	225	78518.....	225
62138.....	197	71045.....	231	73705.....	230	77445.....	225	78635.....	225

78645.....	225	82640.....	493	90621.....	231	99331.....	206	10542-10544.....	106
079003.....	216	82660.....	493	90626.....	231	99333.....	206	10573-10579.....	106
079007.....	216	82840.....	493	90811.....	231	99351.....	206	10581, 10582.....	515
079011.....	216	82860.....	493	90816.....	231	99353.....	206	10592-10597.....	106
079020.....	216	82880.....	493	90821.....	231	99355.....	207	10598, 10599.....	514
80001.....	494	82965.....	494	90826.....	231	99357.....	207	10603-10606.....	96
80411.....	493	82980.....	494	90830.....	231	99359.....	207	10607-10609.....	103
80416.....	493	82982.....	494	90835.....	231	99361.....	207	10610, 10611.....	97
80511.....	493	83108.....	542	90840.....	231	99365.....	207	10614-10616.....	96
80516.....	493	83113.....	542	90845.....	231	99367.....	208	10620-10623.....	96
80611.....	493	83118.....	542	91011.....	231	99369.....	207	10626-10628.....	96
80616.....	493	83122.....	542	91016.....	231	99371.....	208	10630-10633.....	96
80621.....	493	83160.....	542	91021.....	231	99373.....	208	10636-10638.....	96
80626.....	493	83165.....	542	91026.....	231	99375.....	208	10641-10643.....	96
80811.....	493	83408.....	542	91030.....	231	99377.....	208	10644-10649.....	97
80816.....	493	83411.....	542	91035.....	231	99381.....	208	10652-10662.....	96
80821.....	493	83422.....	542	91040.....	231	99383.....	207	10663-10668.....	97
80826.....	493	84152.....	261	91045.....	231	99385.....	207	10669-10671.....	97
80830.....	493	84186.....	261	91060.....	231	99387.....	207	10672-10682.....	96
80835.....	493	84202.....	261	91080.....	231	99415.....	201	10690-10694.....	99
80840.....	493	84204.....	261	91216.....	231	99415.....	201	10699, 10700.....	103
80845.....	493	84212.....	261	91221.....	231	99422.....	201	10701, 10702.....	101
81003.....	493	84214.....	261	91226.....	231	99423.....	201	10703-10705.....	102
81011.....	493	84216.....	261	91230.....	231	99425.....	201	10708-10710.....	99
81016.....	493	84252.....	261	91235.....	231	99425.....	201	10712, 10713.....	99
81021.....	493	84254.....	261	91240.....	231	99435.....	201	10733, 10734.....	475
81026.....	493	84256.....	261	91245.....	231	99435.....	201	10745, 10746.....	100
81030.....	493	84304.....	261	91260.....	231	99445.....	201	10747, 10748.....	101
81035.....	493	84306.....	261	91316.....	231	99445.....	201	10749, 10751-10753.....	100
81040.....	493	84314.....	261	91326.....	231	99500.....	203	10800-10821.....	98
81045.....	493	84358.....	261	91416.....	231	99502.....	203	10822, 10823.....	97
81060.....	493	84404.....	261	91421.....	231	99504.....	203	10824-10831.....	98
81211.....	493	84406.....	261	91426.....	231	99506.....	203	10832-10839.....	98
81216.....	493	84408.....	261	91430.....	231	99508.....	203	10840-10846.....	98
81221.....	493	84456.....	261	91440.....	231	99510.....	203	10847-10854.....	98
81226.....	493	84459.....	261	91445.....	231	99512.....	203	10855-10862.....	98
81230.....	493	84506.....	261	91460.....	231	99514.....	203	10863-10869.....	98
81235.....	493	84509.....	261	91616.....	231	99516.....	203	10870-10873.....	97
81240.....	493	84725.....	261	91621.....	231	99520.....	204	10874-10877.....	97
81245.....	493	84818.....	261	91626.....	231	99522.....	204	10878-10880.....	97
81260.....	493	84820.....	261	91630.....	231	99530.....	204	10881-10883.....	97
81280.....	493	84825.....	261	91635.....	231	99532.....	204	10901-10906.....	105
81316.....	493	84831.....	261	91640.....	231	99600.....	204	10915-10919.....	105
81326.....	493	84835.....	261	91645.....	231	99602.....	205	10925-10929.....	105
81335.....	493	86023.....	261	91660.....	231	99604.....	205	10951-10954.....	475
81416.....	493	86515.....	496	91680.....	231	99615.....	201	10956, 10957.....	475
81421.....	493	86525.....	496	91821.....	231	99615.....	201	10965-10968.....	475
81426.....	493	86580.....	496	91826.....	231	99625.....	201	10975-10978.....	475
81430.....	493	86630.....	496	91835.....	231	99625.....	201	10985-10988.....	475
81440.....	493	87510.....	496	91840.....	231	99634.....	206	10990-10995.....	475
81445.....	493	87515.....	496	91845.....	231	99635.....	201	11000-11002.....	491
81460.....	493	87525.....	496	91860.....	231	99635.....	201	11230-11232.....	163
81616.....	493	87580.....	496	92021.....	231	99645.....	201	11281-11284.....	163
81621.....	493	87630.....	496	92026.....	231	99645.....	201	11580-11583.....	163
81626.....	493	88515.....	496	92030.....	231	99800.....	209	12006-12009.....	487
81630.....	493	88525.....	496	92040.....	231	588150.....	44	12011, 12012.....	533
81635.....	493	88580.....	496	92045.....	231	611035.....	522	12021-12026.....	146
81640.....	493	88630.....	496	92060.....	231	00001-00015.....	150	12122-12125.....	487
81645.....	493	88715.....	255	92080.....	231	00299-00300.....	517	12253-12259.....	552
81660.....	493	88725.....	255	92221.....	231	00302-00304.....	517	12263, 12264.....	551
81680.....	493	88730.....	255	92226.....	231	00321, 00322.....	519	12270, 12271.....	534
81701, 81702.....	493	88733.....	255	92230.....	231	01404, 01405.....	533	12283, 12284.....	553
81703.....	494	89015.....	255	92240.....	231	01410, 01411.....	533	12288, 12289.....	553
81704.....	493	89025.....	255	92245.....	231	01424, 01425.....	524	12295, 12296.....	553
81720.....	232	89028.....	255	92260.....	231	01435-01438.....	531	12302, 12303.....	510
81722.....	232	89033.....	255	92280.....	231	01512, 01513.....	528	12304, 12305.....	510
81724.....	232	89115.....	256	92426.....	231	01624, 01625.....	523	12316, 12317.....	510
81821.....	493	89125.....	256	92440.....	231	07901, 07902.....	216	12330, 12331.....	533
81826.....	493	89180.....	256	92460.....	231	079015, 079016.....	216	12337, 12338.....	534
81835.....	493	89230.....	256	92480.....	231	10000K.....	514	12347-12349.....	536
81840.....	493	89300.....	256	92530.....	231	10000L.....	514	12350-12353.....	512
81845.....	493	89350.....	256	92545.....	231	10013, 10014.....	478	12371, 12372.....	166
81860.....	493	89360.....	256	92560.....	231	10043-10048.....	476	12374-12378.....	166
81908.....	236	89365.....	256	92626.....	231	10050, 10051.....	476	12385-12387.....	551
81910.....	236	89370.....	256	92640.....	231	10078, 10079.....	515	12395-12398.....	210
82021.....	493	89375.....	256	92660.....	231	10080, 10081.....	104	12400-12403.....	509
82026.....	493	89380.....	256	92840.....	231	10083, 10084.....	104	12421-12423.....	509
82030.....	493	89385.....	256	92860.....	231	10086-10088.....	104	12443-12446.....	509
82040.....	493	89415.....	256	92880.....	231	10092, 10093.....	104	12448, 12449.....	509
82045.....	493	89425.....	256	93110.....	238	10103, 10104.....	104	12470-12474.....	509
82060.....	493	89428.....	256	93111.....	243	10108, 10109.....	104	12481-12483.....	509
82080.....	493	89431.....	256	93126.....	238	10114-10117.....	106	12485, 12486.....	509
82221.....	493	89435.....	256	93171.....	237	10144-10148.....	106	12487, 12488.....	509
82226.....	493	89438.....	256	93411.....	243	10150-10156.....	104	12489, 12490.....	509
82230.....	493	89441.....	257	99001.....	201	10161-10165.....	104	12502-12505.....	145
82240.....	493	89445.....	257	99241.....	204	10167-10168.....	104	12511-12515.....	145
82245.....	493	89448.....	257	99243.....	204	10171-10176.....	104	12520-12522.....	145
82260.....	493	89507.....	238	99245.....	204	10182-10185.....	104	12523, 12524.....	146
82280.....	493	89510.....	238	99307.....	205	10190-10196.....	104	12526, 12527.....	146
82426.....	493	89590.....	238	99309.....	205	10207, 10208.....	104	12546, 12547.....	145
82440.....	493	90003.....	231	99311.....	205	10225, 10226.....	106	12581-12583.....	145
82460.....	493	90411.....	231	99313.....	205	10330-10333.....	476	12587, 12588.....	145
82480.....	493	90416.....	231	99315.....	205	10490-10493.....	476	12590-12592.....	145
82530.....	493	90511.....	231	99317.....	205	10502, 10503.....	514	12601-12605.....	145
82545.....	493	90516.....	231	99325.....	208	10513-10518.....	106	12611-12613.....	147
82560.....	493	90611.....	231	99327.....	208	10536-10538.....	514	12621-12625.....	147
82626.....	493	90616.....	231	99329.....	208	10540, 10541.....	515	12631-12635.....	147

12731, 12732.....	167	18500-18507.....	48	27023, 27024.....	268	34316-34322.....	66	41166-41179.....	159
12741, 12742.....	167	18508-18525.....	47	27030-27033.....	541	34324-34325.....	66	41202-41207.....	215
12753-12760.....	554	18527-18530.....	47	27035-27038.....	268	34438-34444.....	471	41216, 41217.....	215
12777, 12778.....	554	18533-18541.....	48	27039-27045.....	543	34446-34451.....	471	41240, 41241.....	158
12786-12789.....	554	18542-18545.....	48	27100, 27101.....	237	34454, 34455.....	471	41242, 41243.....	156
12791-12793.....	554	18546, 18547.....	48	27119, 27120.....	237	34912-34915.....	473	41245, 41246.....	158
12820, 12821.....	168	18548, 18549.....	48	27129, 27130.....	237	35006H.....	472	41250, 41251.....	158
12900-12909.....	537	18551-18553.....	53	27167, 27168.....	237	35008H.....	472	41256, 41257.....	158
12910-12915.....	537	18559-18567.....	48	28202, 28203.....	507	35012H.....	472	41257, 41258.....	156
12918, 12919.....	537	18569-18571.....	48	28205-28207.....	507	35111, 35112.....	552	41260, 41261.....	158
12920, 12921.....	538	18584-18586.....	52	28214, 28215.....	116	35112H.....	473	41265, 41266.....	158
12922-12924.....	538	18587-18595.....	48	28250-28253.....	192	35121, 35122.....	552	42001, 42002.....	545
12929-12931.....	538	18608, 18609.....	48	28310-28314.....	112	35125H.....	473	42005-42008.....	170
12935-12939.....	539	18610-18622.....	47	28380-28382.....	116	35240-35249.....	471	42017-42020.....	545
12941-12943.....	538	18625, 18626.....	48	28470-28472.....	107	35256-35274.....	471	42038, 42039.....	544
12947, 12948.....	538	18628, 18629.....	48	28480, 28481.....	107	35320, 35321.....	550	42042-42045.....	544
12952, 12953.....	538	18633-18643.....	48	28489, 28490.....	114	35348-35359.....	67	42050, 42051.....	546
13001, 13002.....	482	18644-18648.....	49	28492, 28493.....	114	35380-35387.....	58	42231-42234.....	178
13010-13013.....	138	18649-8652.....	49	28502, 28503.....	506	35406-35424.....	66	42235-42239.....	548
13101, 13102.....	532	18653-18656.....	50	28521-28523.....	108	35448-35459.....	57	42241-42243.....	548
13101C, 13102C.....	532	18657-18665.....	49	28531-28533.....	505	35468-35479.....	57	42340, 42341.....	573
13101L, 13102L.....	532	18666-18668.....	50	28541-28548.....	506	35522-35524.....	549	42342-42344.....	575
13101R.....	532	18671-18674.....	53	28561-28563.....	506	35530C-35532C.....	550	42348, 42349.....	575
13101Z, 13102Z.....	532	18691-18695.....	51	28570-28574.....	505	35530N-35532N.....	550	42352-42354.....	576
13131, 13132.....	531	18821, 18822.....	47	28580, 28581.....	116	35530Z-35532Z.....	550	42901-42905.....	188
13133, 13134.....	532	18826, 18827.....	47	28590-28598.....	505	35586-35587.....	549	42915-42917.....	188
13601-13603.....	508	18835, 18836.....	47	28660-28662.....	478	35591-35593.....	528	42940-42942.....	192
13604-13610.....	508	18867, 18868.....	53	28670-28672.....	478	35606-35630.....	59	43021-43023.....	528
13611-13613.....	508	18871, 18872.....	53	28700-28702.....	109	35606H-35628H.....	473	43025-43027.....	528
13615, 13616.....	508	18901-18904.....	55	28703-28709.....	107	35630H.....	473	43032, 43033.....	529
13621, 13622.....	508	18908, 18909.....	56	28710-28712.....	109	35632H.....	473	43035, 43036.....	529
13625, 13626.....	508	18921-18930.....	54	28713-28716.....	107	35668-35679.....	471	43050, 43051.....	529
13700-13704.....	508	18932-18936.....	54	28720-28722.....	109	35688-35699.....	58	43053-43056.....	529
13713-13715.....	508	18941-18943.....	54	28730-28736.....	110	35700, 35701.....	196	43058, 43059.....	529
13717, 13718.....	508	18971-18980.....	54	28750-28752.....	108	35702-35704.....	196	43062, 43063.....	528
14006-14008.....	184	18982-18986.....	54	28770-28773.....	109	35720, 35721.....	551	43065-43069.....	528
14010-14012.....	184	18991-18993.....	54	28780-28787.....	110	35726-35729.....	196	43120-43129.....	529
14311, 14312.....	210	18998, 18999.....	54	28790-28796.....	110	35732-35734.....	551	43130-43133.....	530
14313-14316.....	210	19014-19016.....	492	29020, 29021.....	69	35737-35740.....	195	43141-43147.....	529
14361-14363.....	488	20102, 20103.....	481	29060-29069.....	514	35743, 35744.....	196	43150-43153.....	530
14371-14373.....	166	20112, 20113.....	481	29095-29098.....	73	35801, 35802.....	550	43154-43157.....	529
15173, 15174.....	144	20112K, 20113K.....	481	29319-29322.....	115	35803-35806.....	550	43160-43163.....	530
15186, 15187.....	143	20115K.....	481	29705, 29706.....	117	36006H.....	473	43170, 43171.....	530
15821-15831.....	140	20117K.....	481	29710-29712.....	117	36008H.....	473	43172-43175.....	530
15901-15905.....	527	20119K.....	481	29720-29722.....	117	36012H.....	473	43201-43203.....	527
15922-15929.....	139	20132, 20133.....	137	29730-29735.....	539	36020, 36021.....	60	44011-44014.....	265
15932-15939.....	139	20132K, 20133K.....	137	29736-29747.....	540	36024, 36025.....	60	44110-44113.....	265
16704-16714.....	540	20133K.....	137	30009H.....	480	36048-36050.....	61	44211, 44212.....	265
17011-17013.....	490	20135K.....	137	30018H.....	480	36052, 36053.....	61	44311, 44312.....	497
17101-17103.....	507	20137K.....	137	30028, 30029.....	133	36070, 36071.....	61	44411, 44412.....	265
17200-17202.....	119	20142, 20143.....	137	30038, 30039.....	134	36073, 36074.....	61	44511, 44512.....	265
17212, 17213.....	119	20142K, 20143K.....	137	30068, 30069.....	480	36106-36110.....	63	44611, 44612.....	265
17215-17217.....	119	20145K.....	137	30092-30096.....	134	36146-36148.....	62	44801-44804.....	266
17335-17338.....	556	20147K.....	137	30300, 30301.....	133	36150, 36151.....	62	44811-44814.....	266
17348-17351.....	556	20205, 20206.....	481	30310, 30311.....	133	36172-36175.....	64	44821-44825.....	266
17364-17366.....	556	20301-20303.....	137	31003-31006.....	135	36412, 36413.....	68	44831-44835.....	266
17370, 17371.....	172	20311-20313.....	481	31009H.....	481	36436, 36437.....	68	44841-44845.....	266
17375-17377.....	172	20331-20333.....	481	31018H.....	481	36550, 36551.....	472	44850-44861.....	266
17381-17383.....	172	20342, 20343.....	482	31170-31177.....	149	36580, 36581.....	67	44870-44877.....	266
17384-17387.....	172	20351-20353.....	137	31180-31187.....	149	36584, 36585.....	67	45000CM-45006CM.....	566
17391-17393.....	173	20510-20513.....	482	31300, 31301.....	481	36620, 36621.....	60	45002A.....	561
18003, 18004.....	161	21043, 21044.....	516	31302-31305.....	135	36624, 36625.....	60	45005A.....	561
18007-18010.....	161	21053-21055.....	516	31339, 31340.....	169	36694, 36695.....	62	45015Z.....	565
18013, 18014.....	162	23018L.....	491	31360-31363.....	169	36800-36804.....	64	45016-45020.....	565
18015, 18016.....	161	23118K.....	491	31364-31368.....	169	36805-36809.....	64	45021Z.....	565
18104-18113.....	47	23120, 23121.....	165	31372-31374.....	169	36811-36813.....	58	45022, 45023.....	565
18104P, 18105P.....	47	23301-23303.....	540	31388-31390.....	620	38001K.....	484	45023Z.....	565
18121-18124.....	53	23305, 23306.....	540	31396, 31397.....	237	38020-38023.....	171	45025-45031.....	565
18126-18129.....	53	24232K.....	500	32020, 32021.....	170	40011-40013.....	211	45027A.....	561
18150-18155.....	48	24240K.....	500	32033-32036.....	539	40015-40019.....	211	45032Z-45034Z.....	565
18165-18167.....	47	24250K.....	500	32053-32056.....	527	40026-40028.....	212	45075A.....	561
18182-18186.....	47	24263K.....	500	32060, 32061.....	527	40032-40034.....	211	45076A.....	561
18187, 18188.....	118	24432K.....	500	32134-32136.....	174	40036, 40037.....	213	45087A.....	560
18191-18195.....	51	24440K.....	500	32202, 32203.....	170	40060-40062.....	214	45096B-45100B.....	566
18306-18308.....	47	24450K.....	500	32234-32236.....	174	40065, 40066.....	214	45115-45119.....	563
18310.....	47	24463K.....	500	32244-32246.....	174	40070-40073.....	214	45128B.....	566
18312-18317.....	47	24475K.....	500	32354-32356.....	174	40080-40082.....	214	45129B, 45130B.....	566
18319-18322.....	47	24550K.....	500	32364-32366.....	174	40123-40127.....	553	45131B.....	566
18341-18344.....	53	24565K.....	500	32520, 32521.....	248	41003, 41004.....	150	45132B, 45133B.....	566
18346-8349.....	53	24575K.....	500	32550-32552.....	248	41011, 41012.....	150	45247B, 45248B.....	566
18355-18359.....	48	24590K.....	500	32613-32615.....	176	41014, 41015.....	150	45254A.....	561
18360-18365.....	47	24662K.....	500	32623-32625.....	176	41022-41025.....	150	45261A.....	561
18382-18386.....	47	24666K.....	500	32633-32635.....	176	41100-41104.....	155	45263CM.....	566
18391-18394.....	51	24670K.....	500	32643-32645.....	176	41106-41117.....	155	45267A-45269A.....	564
18400-18409.....	55	24750-24753.....	84	32861, 32862.....	247	41131-41138.....	159	45271A-45275A.....	564
18410-18430.....	54	24901-24903.....	500	33105, 33106.....	36	41140, 41141.....	158	45274A.....	560
18433-18439.....	55	26273-26280.....	236	33116, 33117.....	33	41142, 41143.....	155	45274X.....	564
18440-18460.....	54	26401, 26402.....	495	34006H.....	472	41144, 41145.....	158	45277A-45281A.....	564
18463-18470.....	55	26404, 26405.....	495	34008-34010.....	59	41146, 41147.....	156	45282CM.....	566
18471-18473.....	55	26408, 26409.....	495	34008H.....	472	41148, 41149.....	158	45283A, 45284A.....	564
18474-18476.....	55	26410, 26411.....	541	34012-34014.....	59	41150, 41151.....	155	45293-45297.....	563
18479-18480.....	55	26413-26418.....	541	34012H.....	472	41152, 41153.....	158	45310B.....	566
18481, 18482.....	55	26437, 26438.....	495	34018-34022.....	59	41154, 41155.....	155	45311B.....	566
18485-18488.....	55	26612-26614.....	236	34024, 34025.....	59	41155, 41156.....	158	45314B-45320B.....	565
18492, 18493.....	55	26624-26626.....	236	34054-34067.....	60	41158, 41159.....	155	45335-45344.....	566
18494, 18495.....	56	26634-26636.....	236	34308-34310.....	66	41160-41162.....	157	45339A.....	562
18496, 18497.....	55								

45343A, 45344A.....	561	48442P.....	89	61008, 61009.....	519	69970, 69971.....	539	98214-98216.....	217
45344X.....	564	48460-48473.....	89	61012-61016.....	517	73103-73110.....	230	98224-98226.....	217
45351A, 45352A.....	564	48474-48483.....	89	61100-61105.....	522	75762, 75763.....	485	98234-98236.....	217
45353-45355.....	566	48484-48496.....	89	61106-61109.....	523	76003-76016.....	222	98244-98246.....	217
45354C-45356C.....	565	48497-48519.....	90	61210, 61211.....	517	76018-76100.....	222	98254-98256.....	217
45359A, 45360A.....	564	48520-48526.....	89	61215, 61216.....	518	76135P.....	222	99200, 99201.....	203
45360CM.....	566	48527-48533.....	89	61311, 61312.....	517	76140P.....	222	99202, 99203.....	203
45361-45366.....	564	48534-48546.....	89	61315, 61316.....	519	76145P.....	222	99204, 99205.....	203
45362A.....	564	48547-48559.....	89	61320-61337.....	160	76150P.....	222	99206, 99207.....	203
45365C.....	564	48565-48574.....	89	61344, 61345.....	160	76155P.....	222	99208-99219.....	203
45369A.....	564	48578-48597.....	90	61359-61366.....	486	76160P.....	222	99220-99223.....	204
45399-45413.....	562	48601-48608.....	475	61368, 61369.....	486	76165P.....	222	99230-99233.....	204
45429A.....	562	48611-48618.....	475	61370, 61371.....	486	76170P.....	222	99300, 99301.....	204
45431-45435.....	565	49020-49034.....	268	61372-61374.....	486	76175P.....	222	99302-99305.....	205
45432A.....	560	49040-49046.....	268	61376-61379.....	486	76180P.....	222	99334, 99335.....	206
45433A.....	561	49050-49056.....	268	61381-61385.....	486	76185P.....	222	99391-99394.....	202
45435A.....	562	49060-49065.....	266	61401, 61402.....	532	76190P.....	222	99412, 99413.....	201
45437A.....	560	49070-49075.....	266	61501-61504.....	523	76195P.....	222	99432, 99433.....	201
45439A.....	560	49080-49085.....	266	61511-61515.....	148	76200P.....	222	99442, 99443.....	201
45441A.....	561	49090-49098.....	267	61521-61525.....	148	76213, 76214.....	222	99612, 99613.....	201
45442A.....	562	49100-49117.....	267	61531-61535.....	148	77010-77013.....	223	99622, 99623.....	201
45443A.....	561	49120-49127.....	267	61536-61539.....	148	77015, 77016.....	223	99632, 99633.....	201
45444A.....	562	49130-49138.....	266	61552, 61553.....	149	77018-77100.....	223	99642, 99643.....	201
45445A.....	561	49140-49148.....	267	61562-61567.....	149	77213, 77214.....	223	BP293999.....	527
45447A.....	560	49150-49154.....	267	61571-61573.....	149	77420-77422.....	225	BP294049, BP294050.....	527
45449A.....	560	49160-49166.....	267	61575-61577.....	149	77430-77432.....	225	BP29434A.....	527
45450A.....	561	49193-49196.....	543	61581-61583.....	148	77440-77442.....	225	BP29436A, BP29437A.....	527
45452A.....	560	51026-51028.....	501	61592, 61593.....	517	77450-77452.....	225	BP294500, BP294501.....	528
45454A.....	561	51029, 51030.....	88	61612, 61613.....	520	77460-77462.....	225	BP299251.....	528
45455A.....	562	51031, 51032.....	88	61621-61623.....	520	77511, 77512.....	225	DKDD36-DKDD42.....	395
45456A.....	561	51034-51037.....	87	61625, 61626.....	519	77514-77518.....	225	DKDP36-DKDP41.....	395
45457A.....	562	52040-52042.....	199	61648, 61649.....	148	78030-78032.....	224	DKMB41-DKMB47.....	394
45458A.....	562	52061-52064.....	198	61651-61655.....	520	78040-78042.....	224	DKRMC40-DKRCM48.....	394
45459A.....	561	52066-52068.....	198	61661-61666.....	160	78050-78052.....	224	DPMAA42-DPMAA44.....	396
45461A.....	561	52301, 52302.....	399	61673-61678.....	521	78060-78062.....	224	DPMAA46.....	396
45466A.....	560	52308-52311.....	398	61680-61683.....	521	78080-78082.....	224	DPRMC40-DPRMC48.....	396
45467A.....	560	55036-55038.....	180	61714, 61715.....	522	78430-78433.....	225	DSRM40-DSRM48.....	396
45471, 45472.....	561	58120-58125.....	49	61738, 61739.....	521	78440-78443.....	225	DSRMW40-DSRMW47.....	396
45490A.....	564	58126-58134.....	49	61760-61763.....	522	78450-78453.....	225	DTRMA40-DTRMA48.....	396
45504BM-45506BM.....	566	58135-58137.....	49	61765, 61766.....	521	78457-78463.....	225	DTRMBU40-DTRMBU48.....	397
45509A.....	560	58138-58140.....	49	61770, 61771.....	521	78511-78513.....	225	DTRMC41.....	396
45509X.....	562	58300-58310.....	49	61781, 61782.....	522	78630-78633.....	225	DTRMC45.....	396
45535D.....	564	58501, 58502.....	49	61783-61790.....	523	78640-78642.....	225	DTRMF40-DTRMF48.....	397
45535F.....	564	58503-58511.....	49	61802, 61803.....	525	78650-78652.....	225	DU001S-DU0013XL.....	329
45536-45538.....	564	58512-58518.....	49	61802-6180.....	525	81005, 81006.....	493	DU012S-DU0123XL.....	330
45541-45545.....	566	58519-58523.....	49	62149-62151.....	197	81005A.....	493	E2015.....	571
45543F.....	564	58524-58529.....	50	64010, 64011.....	541	81710-81719.....	232	E2400.....	571
45546F.....	564	58530-58532.....	50	64105-64107.....	165	81731-81733.....	232	E3420.....	570
45557, 45558.....	565	58533-58542.....	49	64390-64392.....	164	81903-81906.....	236	E3430.....	570
45602-45604.....	565	58543-58548.....	50	66040-66043.....	193	82985, 82986.....	494	E4440.....	571
45602X, 45603X.....	562	58549-58554.....	50	66045-66048.....	193	83101-83106.....	542	E4500V.....	570
45652A.....	562	58713, 58714.....	37	66150-66157.....	502	83101L.....	542	E4700.....	570
45702CM.....	566	58723, 58724.....	38	66181-66188.....	86	83106L.....	542	E5110.....	569
45704CM.....	566	58728, 58729.....	40	66243-66247.....	499	83110, 83111.....	542	E5200.....	569
45712C.....	565	58730, 58731.....	39	66250-66253.....	500	83111F.....	542	E5250.....	569
45740C-45747C.....	564	58736, 58737.....	39	66300-66309.....	130	831135F.....	542	E5310.....	569
45748C.....	565	58779, 58780.....	38	66310-66319.....	131	83115, 83116.....	542	E5459.....	569
45763B, 45764B.....	565	58781-58784.....	37	66320-66322.....	130	83118F.....	542	E5550.....	571
45768A, 45769A.....	543	59110B.....	193	66330-66332.....	131	83160F.....	542	E8191.....	571
45780, 45781.....	543	59110C.....	193	66344, 66345.....	127	83401-83406.....	542	E8700.....	568
45782C.....	564	59120B, 59121B.....	193	66346-66348.....	126	83401L.....	542	E8800.....	568
45791C-45796C.....	564	59120C, 59121C.....	193	66350-66358.....	128	83403L.....	542	E8900.....	568
45800B, 45801B.....	565	59130B, 59131B.....	193	66361, 66362.....	127	84132, 84133.....	261	EATFR01, EATFR02.....	623
45869E.....	564	59130C, 59131C.....	193	66370, 66371, 66372.....	125	84141, 84142.....	261	EATFW01-EATFW04.....	622
45923BM-45927BM.....	566	59140B.....	193	66381-66383.....	128	84161-84165.....	261	EATHZ01.....	621
45930BM-45932BM.....	566	59140C.....	193	66384-66387.....	129	84182-84184.....	261	EATL5.....	610
45975CM, 45976CM.....	566	59210B.....	497	66471, 66472.....	124	84206-84208.....	261	EATM01-EATM06.....	626
45982D.....	565	59210C.....	497	66524, 66525.....	71	84308, 84309.....	261	EATM2UWB-EATM4UWB.....	620
45999BM.....	566	59220B.....	497	66700-66702.....	73	84354, 84355.....	261	EATM301A.....	621
46006, 46007.....	351	59220C.....	497	66800-66805.....	71	84720-84722.....	261	EATM301P.....	621
46037-46039.....	340	59230B.....	497	66812-66814.....	71	86011, 86012.....	261	EATNB01.....	621
46055, 46056.....	352	59230C.....	497	66900-66903.....	193	86101-86104.....	255	EATNB02.....	622
46188-46192.....	330	59711-59717.....	184	66910-66912.....	193	87101-87104.....	255	EATOP01.....	624
46194-46197.....	330	60001, 60002.....	546	66920-66922.....	193	88101-88104.....	255	EATP3.....	621
46445, 46446.....	216	60005-60009.....	546	67003-67006.....	489	88111-88114.....	255	EATP5.....	621
46750-46752.....	199	60015, 60016.....	547	67023-67026.....	177	89568, 89569.....	238	EATPD01-EATPD03.....	622
46760-46762.....	199	60020-60028.....	547	67043-67046.....	177	89582, 89583.....	238	EATPD01-EATPD03.....	622
46770-46773.....	199	60040-60042.....	185	67048-67052.....	177	90005, 90006.....	231	EATTHK01-EATTHK03.....	621
46802, 46803.....	82	60045-60048.....	185	67095-67099.....	177	93101-93106.....	243	EATTHK09, EATTHK10.....	621
46830-46833.....	85	60050-60053.....	186	67103-67106.....	489	93101KR.....	243	EATWS01, EATWS02.....	620
46843-6846.....	72	60069, 60070.....	498	67123-67126.....	177	93101L.....	243	EATWW01-EATWW03.....	620
46858-46860.....	79	60089, 60090.....	499	67128-67132.....	177	93103L.....	243	EAVM01-EAVM08.....	626
46863-46865.....	78	60101-60105.....	546	67201, 67202.....	119	93108, 93109.....	243	EAVM1UWK.....	620
46866-46869.....	77	60310-60316.....	548	67206, 67207.....	119	93111F.....	243	EZ60WM.....	503
46876-46878.....	78	60320-60323.....	187	67208-67212.....	118	93121, 93122.....	139	EZ60WP.....	503
46882-46885.....	75	60325-60331.....	187	67241-67244.....	117	93123-93125.....	239	F32000.....	531
46897-46899.....	81	60421, 60422.....	547	69101-69108.....	538	93150F.....	243	F60000.....	530
46911-46915.....	83	60811, 60812.....	525	69201-69207.....	538	93401-93406.....	243	F60001.....	530
46921-46923.....	82	60821, 60822.....	525	69249-69257.....	538	93401KR.....	243	F60003.....	530
46928, 46929.....	83	60831, 60832.....	525	69300-69308.....	538	93408, 93409.....	243	K1415336-K1415346.....	395
46936-46938.....	84	60842, 60843.....	525	69341-69343.....	538	93411F.....	243	K1512140-K1512146.....	395
46940, 46941.....	84	60903-60906.....	526	69348-69351.....	538	93450F.....	243	K1516236-K1516242.....	395
46971-46975.....	74	60972, 60973.....	526	69356, 69357.....	538	98111-98116.....	217	K1536142-K1536148.....	394
48367, 48368.....	91	60975, 60976.....	526	69401, 69402.....	533	98121-98126.....	217	K1546142-K1546148.....	395
48402-48410.....	89	60983, 60984.....	526	69411-69415.....	539	98131-98136.....	217	KL13295.....	560
48402P.....	89	60991, 60992.....	526	69511-69515.....	539	98144-98146.....	217	KL13402.....	561
48441-48450.....	89	60995, 60996.....	525	69810-69813.....	539	98154-98156.....	217	KL13446, KL13447.....	562

KL13461.....	562	L1200200.....	350	L221407K-L221411K.....	373	L3060239-L3060247.....	380	L4040554.....	283
KL13465.....	562	L1200300.....	350	L230107W-L230111W.....	376	L3060339-L3060347.....	379	L4040556.....	283
KL13489.....	562	L1200400.....	350	L230109K-L230110K.....	376	L3060436-L3060442.....	379	L4040560.....	283
KL13491.....	562	L120050S.....	351	L230207W-L230211W.....	376	L3060536-L3060542.....	380	L4040601-L4040606.....	277
KL13536.....	560	L1200600.....	350	L230209K-L230210K.....	376	L3060639-L3060647.....	379	L4040748.....	282
KL187171.....	560	L1200700.....	351	L230307K-L230309K.....	376	L3070141-L3070147.....	394	L4040750.....	282
KL202400, KL202401.....	560	L120080S.....	351	L230407K-L230411K.....	375	L3070240-L3070247.....	394	L4040752.....	282
KL202401.....	560	L120090S.....	350	L230507W-L230510W.....	376	L3080139-L3080147.....	393	L4040754.....	282
KL221161.....	560	L120100S.....	351	L240109W-L240110W.....	376	L3080239-L3080247.....	393	L4040756.....	282
KL224084.....	560	L1500100.....	342	L240110K.....	376	L3080439-L3080447.....	393	L4040760.....	282
KL237786, KL237787.....	564	L1500200.....	341	L240210W.....	376	L3090139.....	317	L4040801-L4040806.....	278
KL292437.....	564	L1500300.....	341	L240310W.....	377	L3090143.....	317	L4041001-L4041006.....	272
KL293646-KL293648.....	564	L1500400.....	341	L240410W.....	377	L3090239.....	317	L4041101-L4041106.....	318
KL294609.....	564	L1500500.....	340	L240507K-L240509K.....	377	L3090243.....	317	L4041201-L4041206.....	318
KL302042-KL302046.....	564	L1510100.....	343	L250108K-L250111K.....	370	L3090339.....	317	L4050148.....	281
KL302049.....	564	L1510200.....	344	L250208K-L250211K.....	370	L3090343.....	317	L4050150.....	281
KL321509.....	562	L1510300.....	344	L250308K-L250311K.....	370	L3090439.....	317	L4050152.....	281
KL321511.....	562	L1510400.....	343	L250408K-L250411K.....	371	L3090443.....	317	L4050154.....	281
KL321513.....	562	L1510500.....	343	L250508W-L250511W.....	371	L3090539.....	317	L4050156.....	281
KL321653.....	563	L1520100.....	348	L250509K-L250510K.....	371	L3090543.....	317	L4050160.....	281
KL321655.....	563	L1520200.....	348	L250610K.....	369	L3090639.....	317	L4050201-L4050206.....	276
KL321657.....	563	L1520300.....	348	L250708K-L250711K.....	369	L3090643.....	317	L4050348.....	280
KL321689.....	563	L1520400.....	347	L250808W-L250810K.....	371	L3090739.....	317	L4050350.....	280
KL321690.....	563	L1520500.....	347	L250809K-L250810K.....	371	L3090743.....	317	L4050352.....	280
KL321694.....	563	L1520600.....	348	L250908K-L250911K.....	369	L3090839.....	317	L4050354.....	280
KL321695.....	563	L1520700.....	348	L251008K-L251011K.....	371	L3090843.....	317	L4050356.....	280
KL321697.....	563	L1530100.....	344	L251108K-L251111K.....	370	L3100101.....	399	L4050360.....	280
KL321698.....	563	L1530200.....	344	L251208K-L251211K.....	369	L3100201.....	399	L4050448.....	283
KL321704.....	563	L1530300.....	344	L270110K.....	364	L4010101-L4010106.....	301	L4050450.....	283
KL321707.....	563	L1530400.....	344	L270208K-L270211K.....	361	L4010201-L4010206.....	301	L4050452.....	283
KL321709.....	563	L1530500.....	344	L270311K.....	365	L4010301-L4010306.....	302	L4050454.....	283
KL322180-KL322185.....	560	L1530600.....	344	L270411K.....	365	L4010401-L4010406.....	298	L4050456.....	283
KL322631.....	559	L1530700.....	345	L270510W.....	364	L4010501-L4010506.....	300	L4050460.....	283
KL322634.....	559	L1540100.....	345	L270608K-L270611K.....	362	L4010601-L4010606.....	302	L4050501-L4050506.....	277
KL322771, KL322772.....	563	L1540200.....	345	L270708K-L270711K.....	362	L4010701-L4010706.....	298	L4050648.....	282
KL322774-KL322776.....	563	L1540300.....	345	L270808K-L270811K.....	361	L4010801-L4010806.....	298	L4050650.....	282
KL322809.....	563	L1540400.....	346	L270910K.....	363	L4010901-L4010906.....	324	L4050652.....	282
KL322811-KL322813.....	563	L1540401.....	347	L271008K-L271011K.....	363	L4011001-L4011006.....	324	L4050654.....	282
KL322815.....	563	L1540500.....	346	L271108K-L271111K.....	363	L4011201-L4011206.....	298	L4050656.....	282
KL322817-KL322819.....	563	L1540501.....	347	L271210W.....	365	L4011301-L4011306.....	299	L4050660.....	282
KL322821-KL322823.....	563	L1540600.....	346	L271310W.....	364	L4011401-L4011406.....	299	L4050701-L4050706.....	278
KL325346.....	559	L1540601.....	347	L271407K-L271409K.....	360	L4011501-L4011506.....	299	L4050901-L4050906.....	273
KL325348.....	559	L1700100.....	338	L271508K-L271511K.....	360	L4011601-L4011606.....	300	L4051001-L4051003.....	275
KL325354.....	559	L1700200.....	338	L271608K-L271611K.....	362	L4011701-L4011706.....	299	L4051101-L4051106.....	319
KL325356.....	559	L1710100.....	338	L271708W-L271711W.....	363	L4011801-L4011806.....	301	L4051201-L4051206.....	319
KL325358.....	559	L171010D.....	338	L271808K-L271811K.....	361	L4020101-L4020106.....	293	L4060148.....	281
KL325362.....	559	L171010K.....	338	L271910K.....	365	L4020201-L4020206.....	293	L4060150.....	281
KL6807.....	561	L171020K.....	338	L280108K-L280111K.....	357	L4020301-L4020306.....	293	L4060152.....	281
KU0360, KU0361.....	518	L1710300.....	338	L280308K-L280311K.....	359	L4020401-L4020406.....	293	L4060154.....	281
KU0387.....	518	L1714012-L1714017.....	285	L280409K-L280411K.....	361	L4020501-L4020506.....	293	L4060156.....	281
KU0414.....	520	L1811300.....	334	L280508K-L280511K.....	358	L4020601-L4020606.....	293	L4060160.....	281
KU0421.....	520	L1812300.....	334	L280608K-L280611K.....	359	L4020701-L4020706.....	327	L4060201-L4060206.....	276
KU0458.....	520	L1813300.....	334	L280709K-L280711K.....	357	L4020801-L4020806.....	327	L4060348.....	280
KU0487.....	520	L1814300.....	334	L280809K-L280811K.....	358	L4021001-L4021006.....	294	L4060350.....	280
KU0499.....	520	L1815300.....	334	L280909K-L280911K.....	358	L4021101-L4021106.....	294	L4060352.....	280
KU0598, KU0599.....	522	L1816300.....	334	L281008K-L281011K.....	359	L4021201-L4021206.....	294	L4060354.....	280
KU0607.....	523	L1915160.....	332	L281108K-L281111K.....	358	L4021301-L4021306.....	294	L4060356.....	280
KU0706.....	523	L1922100.....	332	L281208K-L281211K.....	359	L4021401-L4021406.....	294	L4060360.....	280
KU0708.....	523	L1934100.....	332	L290110K.....	366	L4021501-L4021506.....	294	L4060448.....	283
KU0804.....	521	L1937100.....	332	L290210K-L290211K.....	366	L4021601-L4021606.....	294	L4060450.....	283
KU0807.....	521	L1938100.....	332	L290308W-L290311W.....	362	L4021701-L4021706.....	293	L4060452.....	283
KU0808.....	521	L200110K.....	375	L3010139-L3010147.....	391	L4021801-L4021806.....	293	L4060454.....	283
KU0810.....	521	L200209K-L200211K.....	372	L3010239-L3010247.....	387	L4021901-L4021906.....	293	L4060456.....	283
KU0901.....	521	L2011300.....	342	L3010339-L3010347.....	387	L4022001-L4022006.....	295	L4060460.....	283
KU0902-KU0904.....	522	L210208W-L210211W.....	367	L3010439-L3010447.....	387	L4022101-L4022106.....	295	L4060501-L4060506.....	277
KU1510.....	524	L210209K.....	367	L3010539-L3010547.....	389	L4022201-L4022206.....	295	L4060648.....	282
KU1516.....	524	L210308W-L210311W.....	367	L3010639-L3010647.....	390	L4022301-L4022306.....	295	L4060650.....	282
KU1518.....	524	L210309K.....	367	L3010739-L3010747.....	387	L4022401-L4022406.....	295	L4060652.....	282
KU1527.....	528	L210407W-L210410W.....	367	L3010839-L3010847.....	388	L4030101-L4030106.....	327	L4060654.....	282
KU1614.....	523	L210409K.....	367	L3010939-L3010947.....	390	L4030201-L4030206.....	327	L4060656.....	282
KU1628.....	523	L210507W-L210510W.....	367	L3011039-L3011047.....	388	L4030301-L4030306.....	292	L4060660.....	282
KU1643.....	525	L210509K.....	367	L3011139-L3011147.....	388	L4030401-L4030406.....	292	L4060701-L4060706.....	278
KU1680.....	524	L210609W.....	368	L3011339-L3011347.....	389	L4030501-L4030506.....	292	L4060901-L4060906.....	274
KU1689.....	524	L210910K.....	368	L3011439-L3011447.....	388	L4030601-L4030606.....	292	L4061001-L4061006.....	319
KU1709, KU1710.....	525	L210910W.....	368	L3011539-L3011547.....	386	L4030701-L4030706.....	292	L4061101-L4061106.....	319
KU1829.....	525	L211008K-L211009K.....	368	L3011639-L3011647.....	391	L4030801-L4030806.....	292	L4070101-L4070106.....	328
KU9901.....	528	L211109W-L211110W.....	367	L3011739-L3011747.....	386	L4030901-L4030906.....	292	L4070201-L4070206.....	328
L1010100.....	334	L211207W-L211211W.....	367	L3011839-L3011847.....	386	L4031001-L4031006.....	292	L4070301-L4070306.....	286
L1010200.....	334	L211209K-L211210K.....	367	L3030139-L3030147.....	392	L4031101-L4031106.....	292	L4070401-L4070406.....	286
L1010300.....	334	L211308K-L211310K.....	368	L3030239-L3030247.....	392	L4031201-L4031206.....	292	L4090101-L4090106.....	305
L1020100.....	332	L211410W.....	368	L3030339-L3030347.....	393	L4031301-L4031306.....	292	L4090401-L4090406.....	306
L1020200.....	332	L211507K-L211509K.....	368	L3040139-L3040147.....	384	L4040148.....	281	L4090501-L4090506.....	306
L1020300.....	332	L220108W-L220110W.....	374	L3040236-L3040247.....	381	L4040150.....	281	L4090601-L4090606.....	322
L1020400.....	333	L220209W-L220210W.....	374	L3040339-L3040347.....	381	L4040152.....	281	L4090701-L4090706.....	322
L1020500.....	333	L220307W-L220311W.....	374	L3040439-L3040447.....	383	L4040154.....	281	L4090801-L4090806.....	314
L102060S.....	332	L220309K-L220310K.....	374	L3040539-L3040547.....	383	L4040156.....	281	L4090901-L4090906.....	321
L1030100.....	335	L220407K-L220409K.....	375	L3040636-L3040642.....	382	L4040160.....	281	L4091001-L4091006.....	321
L1030200.....	335	L220510W.....	374	L3040739-L3040747.....	382	L4040301-L4040306.....	276	L4091101-L4091106.....	320
L1030300.....	335	L220510W.....	374	L3040839-L3040847.....	382	L4040448.....	280	L4091201-L4091206.....	320
L1030400.....	335	L220608K-L220611K.....	372	L3040939-L3040947.....	381	L4040450.....	280	L4091301-L4091306.....	326
L1030600.....	335	L220708W-L220711W.....	373	L3041039-L3041047.....	382	L4040452.....	280	L4091401-L4091406.....	326
L1030700.....	335	L220807B-L220810B.....	375	L3041136-L3041142.....	383	L4040454.....	280	L4091501-L4091506.....	314
L1040101-L1040106.....	337	L220910W.....	374	L3041236-L3041242.....	385	L4040456.....	280	L4091601-L4091606.....	304
L1040201-L1040206.....	337	L221008K-L221011K.....	373	L3041336-L3041342.....	385	L4040460.....	280	L4091701-L4091706.....	307
L1040402.....	336	L221108W-L221111W.....	373	L3041439-L3041447.....	383	L4040458.....	283	L4091801-L4091806.....	307
L1040501-L1040506.....	336	L221207K-L221211K.....	372	L3041539-L3041547.....	381	L4040550.....	283	L4091901-L4091	

L4092101-L4092106	306	L9030239-L9030247	400	LPQA82L	287	MNSI383W	531	TOP252S	615
L4092201-L4092206	325	L9030339-L9030347	400	LPQA82XL	287	PEP20UZ	215	TOP431S	615
L4092301-L4092306	303	L9030439-L9030447	400	LPQA882XL	287	PKT001UW	151	TOR201P	612
L4092401-L4092406	311	L9030539-L9030547	401	LPQA88L	287	SA2T	620	TOR241P	612
L4092501-L4092506	323	L9030639-L9030647	400	LPQA88XL	287	SA4T	620	TOR45231	612
L4092601-L4092606	323	L9030739-L9030747	400	LPQA943XL	287	SAPP	620	TOR50291	612
L4092701-L4092706	315	L9040100	401	LPQB64S	288	SNT013	626	TPB1100	615
L4100101-L4100106	322	L9040120	401	LPQB70M	288	SNTTOR45	624	TPB750	615
L4100201-L4100206	322	L9040150	401	LPQB76L	288	SNTTOR50	624	TPD860K	603
L4100301-L4100306	321	L9040200	401	LPQB76M	288	TCU300	591	TPS1051	601
L4100401-L4100406	321	L9040220	401	LPQB76XL	288	TCV18L2	591	TPS750	601
L4100501-L4100506	320	L9040250	401	LPQB822XL	288	TDS125A	596	TPW500K	602
L4100601-L4100606	320	L9040300	401	LPQB82L	288	TDS125B	596	TS121501	599
L4100701-L4100706	313	L9040320	401	LPQB82XL	288	TDS125RK	596	TS152501	599
L4100801-L4100806	326	L9040350	401	LPQB882XL	288	TDS230	596	TS203501	599
L4100901-L4100906	326	L9040400	401	LPQB88L	288	TDW1050	593	TSO15251	599
L4101001-L4101006	307	L9040420	401	LPQB88XL	288	TDW550	592	TSR100	607
L4101101-L4101106	307	L9040450	401	LPQB943XL	288	TDW710	592	TU1450	604
L4101201-L4101206	311	L9040500	401	LPQC64S	287	TDW850K	593	TU1800	604
L4110101-L4110106	313	L9040520	401	LPQC70M	287	TF1201	605	TUV10L	590
L4110201-L4110206	323	L9040600	401	LPQC76L	287	TFR900K	605	TUV36	590
L4110301-L4110306	323	L9040710	401	LPQC76M	287	TFV12	590	TUV550	592
L4110401-L4110406	321	L9040810	401	LPQC76XL	287	TFV18	590	TW2001	607
L4110501-L4110506	321	LPAB64S	284	LPQB82L	287	TFV18B2	590	TW3001	607
L4110601-L4110606	320	LPAB70M	284	LPQC82L	287	TFW150K	606	TW4001	607
L4110701-L4110706	320	LPAB76L	284	LPQC82XL	287	TG18601	604	TWW120	600
L4110801-L4110806	312	LPAB76M	284	LPQC882XL	287	THG600	605	VG18601	634
L4110901-L4110906	311	LPAB76XL	284	LPQC88L	287	THG900	605	VM1650	635
L4120101	316	LPAB822XL	284	LPQC88XL	287	THK20	607	VMG601	633
L4120103	316	LPAB82L	284	LPQC943XL	287	THK31G	607	VML20068	632
L4120105	316	LPAB82XL	284	LPQD64S	288	THL1800	610	VPB400	635
L4120201	316	LPAB882XL	284	LPQD70M	288	THL2000B	610	VPB750	635
L4120203	316	LPAB88L	284	LPQD76L	288	THL2000C	610	VS121301	635
L4120205	316	LPAB88XL	284	LPQD76M	288	THP1300	601	VS152001	635
L4130101-L4130103	328	LPAB943XL	284	LPQD76XL	288	THP1600	601	VU1400	634
L4130201-L4130203	328	LPAK1S-LPAK13XL	285	LPQD822XL	288	THP1800	601	VZM650	631
L4130501-L4130506	327	LPA064S	284	LPQD82L	288	THV18UL	591	VZM700	631
L4130601-L4130606	327	LPA070M	284	LPQD82XL	288	THX1652	594	VZO180	633
L4130701-L4130706	309	LPA076L	284	LPQD882XL	288	THZ600	597	VZP1300	634
L4130801-L4130806	310	LPA076M	284	LPQD88L	288	THZ800	597	VZP1500	634
L4130901-L4130906	310	LPA076XL	284	LPQD88XL	288	TJ15AK	589	VZR402	633
L4131001-L4131006	309	LPQD822XL	284	LPQD943XL	288	TJ1LD	589	VZS125B	631
L4131101-L4131106	309	LPA082L	284	LPQE64S	287	TJ2AK	589	VZS125C	632
L4131201-L4131206	310	LPA082XL	284	LPQE70M	287	TJ3LD	589	VZS125D	632
L4131301-L4131306	324	LPQD882XL	284	LPQE76L	287	TJD90	588	VZS230	632
L4131401-L4131406	324	LPA088L	284	LPQE76M	287	TJE100	588	VZU240	630
L4140101-L4140106	307	LPA088XL	284	LPQE76XL	287	TJP60	587	VZV12C	630
L4140201-L4140206	307	LPA0943XL	284	LPQE822XL	287	TJPS70	587	VZV18C	630
L4140311-L4140314	290	LPAS1S-LPAS13XL	285	LPQE82L	287	TJR50	587	VZV18C2	630
L4140322-L4140325	290	LPAS64S	284	LPQE82XL	287	TJS40	587	VZW501	630
L4140333-L4140336	290	LPAS70M	284	LPQE882XL	287	TJV10	586	VZW601	630
L4140411-L4140414	290	LPAS76L	284	LPQE88L	287	TJV10AL	586	VZW711	631
L4140422-L4140425	290	LPAS76M	284	LPQE88XL	287	TJV20	586	VZW801	631
L4140433-L4140436	290	LPAS76XL	284	LPQE943XL	287	TKU1000	592	YBS750FP	625
L4140511-L4140514	289	LPAS822XL	284	LPQK64S	287	TM16105	616	YTOA0330	625
L4140522-L4140525	289	LPAS82L	284	LPQK70M	287	TM18135	616	YTOA0430	625
L4140533-L4140536	289	LPAS82XL	284	LPQK76L	287	TM18165	616	YTOC0391	624
L4140611-L4140614	289	LPAS882XL	284	LPQK76M	287	TM300, TM301	608	YTOC0392	624
L4140622-L4140625	289	LPAS88L	284	LPQK76XL	287	TMB1500K	597	YTOD0206, YTOD0207	625
L4140633-L4140636	289	LPAS88XL	284	LPQK822XL	287	TMC240	598	YTOD0304, YTOD0305	625
L4140711-L4140714	291	LPAS943XL	284	LPQK82L	287	TMC350	598	YTOK0558	625
L4140722-L4140725	291	LPB01S-LPBO13XL	310	LPQK82XL	287	TMG170	608	YTOK0732	625
L4140733-L4140736	291	LPBP1S-LPBP13XL	300	LPQK882XL	287	TMG170K	609	YTOK0866	625
L4140801-L4140806	307	LPBP2S-LPBP23XL	301	LPQK88L	287	TMGK500	592	YTOP25FL	624
L4150148	280	LPBP3S-LPBP33XL	301	LPQK88XL	287	TMM1050X	595	YTOP25N1-YTOP25N3	624
L4150150	280	LPBR0148	279	LPQK943XL	287	TMM1250	595	YTOP25S1, YTOP25S2	624
L4150152	280	LPBR0150	279	LPQL64S	288	TMM1350X	595	YTOP43FL	624
L4150154	280	LPBR0152	279	LPQL70M	288	TMM1600X	596	YTOP43SW	624
L4150156	280	LPBR0154	279	LPQL76L	288	TMM710K	595	YTOPSZ01	624
L4150160	280	LPBR0156	279	LPQL76M	288	TMM800	594	YTOR02FL, YTOR03FL	625
L4150202-L4150206	329	LPBR0160	279	LPQL76XL	288	TMM900K	594	YTOR02PW, YTOR03PW	624
L4160101-L4160106	329	LPKA1M-LPKA12XL	316	LPQL822XL	288	TMO450A	598	YTOR02SW	625
L4170101-L4170106	326	LPKF1S-LPKF12XL	296	LPQL82L	288	TMR570	599	YTOR4004	625
L4170201-L4170206	308	LPKF2S-LPKF22XL	296	LPQL82XL	288	TMR172K	599	YTOR4038	625
L4170301-L4170306	308	LPKF3S-LPKF32XL	297	LPQL882XL	288	TMR800K	600	YTOR4162	624
L4170401-L4170406	308	LPKO1S-LPKO13XL	327	LPQL88L	288	TMT810	598	YTOR4163	624
L4180201-L4180206	297	LPKO2S-LPKO23XL	327	LPQL88XL	288	TMT810K	598	YTOR5067	625
L4180301-L4180306	296	LPKOMA39-LPKOMA47	394	LPQL943XL	288	TMX122	594	YTOR5193	624
L4180401-L4180406	296	LPKS1S-LPKS13XL	305	LPSOMA39-LPSOMA47	380	TMY850	593	YTOR5194	624
L8010100	354	LPKS2S-LPKS23XL	304	LPSR0148	279	TNB380K	601	YZ1E0106	626
L8010200	354	LPKT1M-LPKT12XL	316	LPSR0150	279	TOA32122	617	YZ1E0905	625
L8010300	354	LPKZ1S-LPKZ13XL	313	LPSR0152	279	TOA38141	617	ZR 58500	49
L8020100	355	LPKZ2S-LPKZ23XL	312	LPSR0154	279	TOB25301	614	ZR10043-ZR10048	476
L8020200	355	LPN001	398	LPSR0156	279	TOB650	614	ZR10080, ZR10081	104
L8020300	355	LPOS01	342	LPSR0160	279	TOC40203	611	ZR10083, ZR10084	104
L8030100	355	LPPOMA39-LPPOMA47	384	LPSR0248	279	TOC40242	611	ZR10086-ZR10088	104
L8030210	355	LPPOMB39-LPPOMB47	384	LPSR0250	279	TOD51501	613	ZR10092, ZR10093	104
L8030220	355	LPPOMC39-LPPOMC47	384	LPSR0252	279	TOD61621	613	ZR10100	104
L8040100	355	LPPP01U	308	LPSR0254	279	TOE3000	614	ZR10103, ZR10104	104
L8040200	354	LPPP11U-LPPP12U	308	LPSR0256	279	TOG2000	619	ZR10106	104
L8040300	354	LPPP11L-LPPP12XL	308	LPSR0260	279	TOG2000K	619	ZR10108, ZR10109	104
L8050100	355	LPQA64S	287	LPTOMC39-LPTOMC47	391	TOG5000K	619	ZR10112	104
L8060100	354	LPQA70M	287	LPTOMD39-LPTOMD47	390	TOK4633C	618	ZR10150-ZR10156	104
L9010100	328	LPQA76L	287	LPTOME39-LPTOME47	390	TOK4642B	617	ZR10158	104
L9020100	328	LPQA76M	287	LPTOMF39-LPTOMF47	389	TOK5152B	618	ZR10161-ZR10165	104
L9020200	328	LPQA76XL	287	LPTOMG39-LPTOMG47	390	TOK5362B	617	ZR10167, ZR10168	104
L9030139-L9030147	400	LPQA822XL	287	MNSI223W	531	TOK5362I	618	ZR10171-ZR10176	104

ZR10182-ZR10185.....	104	ZR18632.....	47
ZR10190-ZR10196.....	104	ZR18633-ZR18643.....	48
ZR10330-ZR10333.....	476	ZR18644-ZR18648.....	49
ZR10490-ZR10493.....	476	ZR18649-ZR8652.....	49
ZR10511.....	106	ZR18653-ZR18656.....	50
ZR10513-ZR10518.....	106	ZR18657-ZR18665.....	49
ZR18104-ZR18113.....	47	ZR18666-ZR18668.....	50
ZR18121-ZR18124.....	53	ZR18669.....	49
ZR18125.....	53	ZR18671-ZR18674.....	53
ZR18126-ZR18129.....	53	ZR18819.....	47
ZR18150-ZR18155.....	48	ZR18821, ZR18822.....	47
ZR18160.....	53	ZR18824.....	47
ZR18162.....	53	ZR18826, ZR18827.....	47
ZR18163.....	47	ZR18830.....	47
ZR18164.....	52	ZR18832.....	47
ZR18165-ZR18167.....	47	ZR18835, ZR18836.....	47
ZR18169.....	47	ZR18838.....	47
ZR18172.....	51	ZR18841.....	47
ZR18175.....	52	ZR18846.....	47
ZR18176.....	47	ZR18850.....	47
ZR18178.....	52	ZR18858.....	53
ZR18179.....	47	ZR18860.....	52
ZR18180.....	52	ZR18863.....	53
ZR18306-ZR18308.....	47	ZR18864.....	52
*ZR18310.....	47	ZR18865.....	52
".....	47	ZR18867, ZR18868.....	53
ZR18312-ZR18317.....	47	ZR18871, ZR18872.....	53
ZR18341-ZR18344.....	53	ZR18874.....	53
ZR18345.....	53	ZR18901-ZR18904.....	55
ZR18346-ZR8349.....	53	ZR18906.....	55
ZR18350.....	53	ZR18907.....	55
ZR18352.....	53	ZR18919.....	54
ZR18354.....	52	ZR18921-ZR18930.....	54
ZR18355-ZR18359.....	48	ZR18932-ZR18936.....	54
ZR18360-ZR18365.....	47	ZR18938.....	54
ZR18367.....	47	ZR18941-ZR18943.....	54
ZR18368.....	53	ZR18946.....	54
ZR18369.....	47	ZR18948.....	54
ZR18372.....	51	ZR18950.....	54
ZR18375.....	52	ZR18952.....	54
ZR18378.....	52	ZR18955.....	54
ZR18382-ZR18386.....	47	ZR18960.....	54
ZR18400-ZR18409.....	55	ZR18969.....	54
ZR18410-ZR18430.....	54	ZR18971-ZR18980.....	54
ZR18431.....	55	ZR18982-ZR18986.....	54
ZR18432.....	54	ZR18991-ZR18993.....	54
ZR18433-ZR18439.....	55	ZR18996.....	54
ZR18440-ZR18460.....	54	ZR18998, ZR18999.....	54
ZR18462.....	54	ZR18ZR182-ZR18ZR186.....	47
ZR18463-ZR18470.....	55	ZR58120-ZR58125.....	49
ZR18471-ZR18473.....	55	ZR58126-ZR58134.....	49
ZR18474-ZR18476.....	55	ZR58135-ZR58137.....	49
ZR18477.....	55	ZR58138-ZR58140.....	49
ZR18478.....	55	ZR58300-ZR58310.....	49
ZR18479, ZR18480.....	55	ZR58501, ZR58502.....	49
ZR18481, ZR18482.....	55	ZR58503-ZR58511.....	49
ZR18484.....	55	ZR58512-ZR58518.....	49
ZR18485-ZR18488.....	55	ZR58519-ZR58523.....	49
ZR18496, ZR18497.....	55	ZR58524-ZR58529.....	50
ZR18500-ZR18507.....	48	ZR58530-ZR58532.....	50
ZR18508-ZR18525.....	47	ZR58533-ZR58542.....	49
ZR18526.....	48	ZR58543-ZR58548.....	50
ZR18527-ZR18530.....	47	ZR58549-ZR58554.....	50
ZR18531.....	48	ZR76003-ZR76016.....	222
ZR18532.....	47	ZR76018-ZR76100.....	222
ZR18533-ZR18541.....	48	ZR76102.....	222
ZR18542-ZR18545.....	48	ZR76110.....	222
ZR18546, ZR18547.....	48	ZR76115.....	222
ZR18548, ZR18549.....	48	ZR76120.....	222
ZR18550.....	48	ZR76125.....	222
ZR18551-ZR18553.....	53	ZR76130.....	222
ZR18554.....	48	ZR76135.....	222
ZR18555.....	53	ZR76140.....	222
ZR18556.....	53	ZR76145.....	222
ZR18557.....	48	ZR76150.....	222
ZR18559-ZR18567.....	48	ZR76155.....	222
ZR18568.....	53	ZR76160.....	222
ZR18569-ZR18571.....	48	ZR76165.....	222
ZR18572.....	51	ZR76170.....	222
ZR18575.....	48	ZR76175.....	222
ZR18576.....	52	ZR76180.....	222
ZR18578.....	52	ZR76185.....	222
ZR18580.....	52	ZR76190.....	222
ZR18581.....	52	ZR76195.....	222
ZR18582.....	53	ZR76200.....	222
ZR18583.....	48	ZR8988.....	54
ZR18584-ZR18586.....	52	ZRZ6105.....	222
ZR18587-ZR18595.....	48	ZRZR18324.....	47
ZR18608, ZR18609.....	48		
ZR18610-ZR18622.....	47		
ZR18623.....	48		
ZR18624.....	47		
ZR18625, ZR18626.....	48		
ZR18627.....	47		
ZR18628, ZR18629.....	48		
ZR18630.....	47		
ZR18631.....	48		



© AUTHORS OPENSTREETMAP | OPENSTREETMAP.ORG

**DISTRIBUTION AND SALES CENTRE**

Łomna Las, ul. Dobra 3,  
05-152 Czosnów  
+48 22 78 59 651  
+48 22 78 59 659  
export@profix.com.pl



**MAIN NOTICE!!!**

1. Profix Ltd remains the sole owner of the copyright to this catalogue and no part of it may be used in the copied version in electronic or any other form without the prior written permission from Profix Ltd.
2. Profix Ltd reserves the right to make any alterations to this catalogue at any given time, including the changes to technical specification, colours and measurements of the products, their packing, etc.
3. All the information, measurements, photos, etc have been placed in this catalogue in good faith but their accuracy is not guaranteed and is subject to change without notice. Profix Ltd accepts no liability in this respect.

**ОБЩАЯ ИНФОРМАЦИЯ!!!**

1. PROFIX принадлежат исключительные авторские права к предложенному каталогу. Ни одна из частей каталога, в печатной, электронной или какой нибудь форме не может быть использована без предварительного письменного согласия PROFIX.
2. PROFIX имеет право внести любые изменения в каталог, в том числе изменения технической спецификации, цвета, размеров и упаковки товара.
3. Размещая в каталоге информацию, размеры, снимки и т.п. мы не преследовали цели ввести кого-либо в заблуждение, но их соответствие не гарантируется и может быть изменено без предупреждения. За возможные изменения наша компания ответственности не несет.

**ALLGEMEINE HINWEISE!!!**

1. Profix stehen die ausschließlichen Urheberrechte an diesem Katalog zu. Kein Teil dieses Katalogs darf in elektronischer Form oder anderweitig ohne vorherige schriftliche Zustimmung von Profix verwendet oder vervielfältigt werden..
2. Profix behält sich das Recht vor, jederzeit Änderungen an dem Katalog vorzunehmen, einschließlich Änderungen der technischen Spezifikationen des Produkts, seiner Farbe, Größe, Verpackung usw.
3. Alle Informationen, Maße, Fotos usw., die im Katalog enthalten sind, werden nach bestem Wissen in den Katalog aufgenommen. Die Richtigkeit dieser Angaben kann jedoch nicht garantiert werden und kann sich ohne vorherige Ankündigung ändern. Die Firma Profix haftet nicht auf dieser Grundlage.





5 903755 140968

DISTRIBUTION AND SALES CENTRE  
ul. Dobra 3, Łomna Las  
05-152 Czosnów

tel.	+48 22 78 59 651 +48 22 78 59 659
e-mail	<a href="mailto:export@profix.com.pl">export@profix.com.pl</a>
www	<a href="http://profix.com.pl">profix.com.pl</a>