



50:1 Micro Metal Gearmotor HP

Overview

These tiny brushed DC gearmotors are intended for use at 6 V, though in general, these kinds of motors can run at voltages above and below this nominal voltage, so they should comfortably operate in the 3 – 9 V range (rotation can start at voltages as low as 0.5 V). Lower voltages might not be practical, and higher voltages could start negatively affecting the life of the motor. The micro metal gearmotors are available in a wide range of gear ratios—from 5:1 up to 1000:1—and offer a choice between three different motors: high-power (HP), medium-power (MP), and standard. With the exception of the 1000:1 gear ratio versions, all of the micro metal gearmotors have the same physical dimensions, so one version can be easily swapped for another if your design requirements change. Please see the micro metal gearmotor comparison table for detailed specifications of all our micro metal gearmotors. This dynamically-sortable table can help you find the gearmotor that offers the best blend of speed, torque, and current-draw for your particular application. A more basic comparison table is available below.

Some versions of the gearmotors are sold with an additional 1 mm-diameter output shaft that protrudes from the rear of the motor. This 4.5mm-long rear shaft rotates at the same speed as the input to the gearbox and offers a way to add a custom-built encoder to provide motor speed or position feedback.

Motor Type	Stall Current@ 6 V	No-Load Speed@ 6 V	Stall Torque@ 6 V	 Pololu Gearbox Shaft Only	 Pololu Gearbox & Motor Shafts
high-power(HP)	1600 mA	6000 RPM	2 oz-in	5:1 micro HP	
		3000 RPM	4 oz-in	10:1 micro HP	10:1 micro HP
		1000 RPM	9 oz-in	30:1 micro HP	30:1 micro HP
		625 RPM	15 oz-in	50:1 micro HP	50:1 micro HP
		400 RPM	22 oz-in	75:1 micro HP	75:1 micro HP
		320 RPM	30 oz-in	100:1 micro HP	100:1 micro HP
		200 RPM	40 oz-in	150:1 micro HP	
		140 RPM	50 oz-in	210:1 micro HP	
		120 RPM	60 oz-in	250:1 micro HP	
		100 RPM	70 oz-in	298:1 micro HP	298:1 micro HP
		32 RPM	125 oz-in	1000:1 micro HP	
medium-power(MP)	700 mA	2200 RPM	3 oz-in	10:1 micro MP	
		730 RPM	8 oz-in	30:1 micro MP	
		420 RPM	13 oz-in	50:1 micro MP	
		290 RPM	17 oz-in	75:1 micro MP	
		220 RPM	19 oz-in	100:1 micro MP	
		150 RPM	24 oz-in	150:1 micro MP	
		75 RPM	46 oz-in	298:1 micro MP	
low-power	360 mA	2500 RPM	1 oz-in	5:1 micro	
		1300 RPM	2 oz-in	10:1 micro	
		440 RPM	4 oz-in	30:1 micro	30:1 micro
		250 RPM	7 oz-in	50:1 micro	50:1 micro
		170 RPM	9 oz-in	75:1 micro	
		120 RPM	12 oz-in	100:1 micro	100:1 micro

		85 RPM	17 oz-in	150:1 micro	
		60 RPM	27 oz-in	210:1 micro	
		50 RPM	32 oz-in	250:1 micro	
		45 RPM	40 oz-in	298:1 micro	298:1 micro
		14 RPM	70 oz-in	1000:1 micro	

Note: The 1000:1 gearmotors can generate enough torque to damage themselves. The stall torque values given for those two motors are theoretical, and we strongly recommend you avoid stalling them.

Details for item #998

Exact gear ratio: $(32 \times 33 \times 35 \times 38) / (15 \times 14 \times 13 \times 10) \approx (51.45:1)$

Gearmotor Dimensions

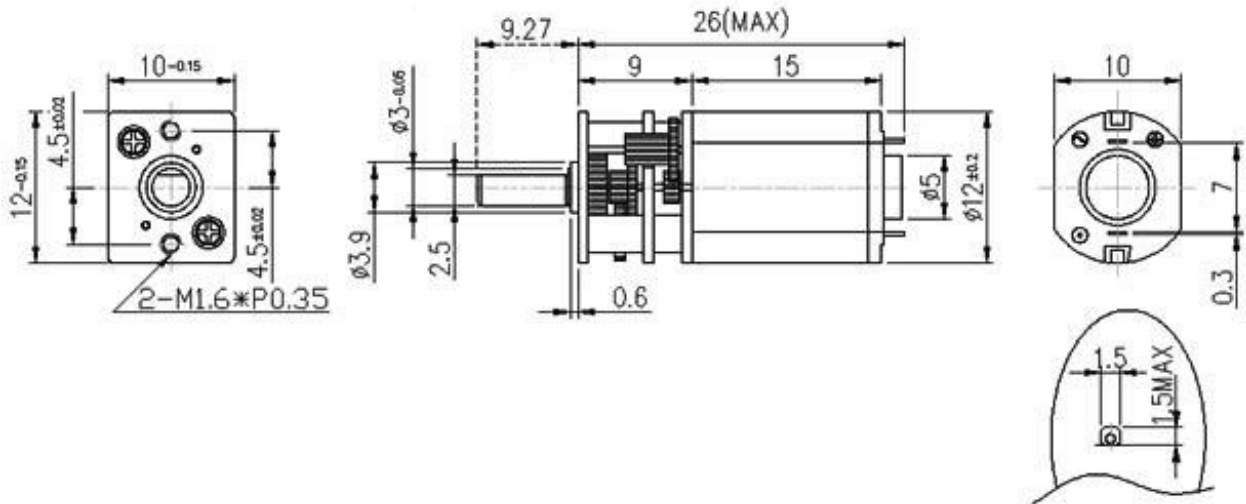

Micro metal gearmotor dimensions (units in mm).

The gearbox has a long (0.365" or 9.27 mm), 3 mm-diameter D-shaped metal output shaft, and the brass faceplate has two mounting holes threaded for M1.6 screws (1.6 mm diameter, 0.35 mm thread pitch). The gearmotor weighs approximately 0.35 oz (10 g). Versions with the extended motor shaft have a 1mm diameter round shaft that protrudes 4.5 mm from the rear of the motor, between the two motor terminals; this is not pictured in the above dimension diagram.

The gearbox on the 1000:1 and 1000:1 HP micro metal gearmotors is 12.5 mm long. All of the other micro metal gearmotors have 9mm-long gearboxes, as shown in the above dimension diagram.

Motor Accessories

- **Wheels and Hubs:** The micro metal gearmotor's output shaft matches our assortment of Pololu wheels and the Solarbotics RW2 ruer wheel. You can also use our Pololu universal mounting hubs to mount custom wheels and mechanism to the micro metal gearmotor's output shaft.



Pololu wheel 32×7mm on a micro metal gearmotor.



Pololu wheel 42×19mm with micro metal gearmotor.



A pair of Pololu universal aluminum mounting hubs for 3 mm diameter shafts.



Black Pololu 70×8mm wheel on a Pololu micro metal gearmotor.



Black Pololu 90×10mm wheel on a Pololu micro metal gearmotor.



Pololu 30T track set with drive sprocket mounted on a micro metal gearmotor to the left; idler sprocket is on the right.

- **Mounting Brackets:** Our mounting bracket (also available in white) and extended mounting bracket are specifically designed to securely mount the gearmotor while enclosing the exposed gears. We recommend the extended mounting bracket for wheels with recessed hubs, such as the Pololu wheel 42×19mm. Our micro metal gearmotors will also work with our 15.5D mm metal gearmotor bracket pair.



Black micro metal gearmotor mounting bracket pair with included screws and nuts.



White micro metal gearmotor mounting bracket pair with included screws and nuts.



Pololu micro metal gearmotor bracket extended with micro metal gearmotor.

- **Quadrature Encoder:** We offer a quadrature encoder for this motor that works with our extended bracket and 42×19mm wheel and provides feedback about wheel rotation (direction and speed). The encoder can be purchased as an individual unit or as part of an encoder set that includes two encoders, a pair of extended brackets, and a pair of

42×19mm wheels—just pick the particular micro metal gearmotor that best suits your application and you have a solution for closed-loop motor control. We also have an optical quadrature encoder that can be mounted to the back of micro metal gearmotors with extended motor shafts.



Encoder for Pololu wheel
42×19mm with wheel, motor, and
bracket.



Example of an installed micro
metal gearmotor reflective optical
encoder.

• **Motor Controllers:** We have a number of motor controllers that make it easy to drive these micro metal gearmotors, including our qik 2s9v1 dual serial motor controller and our programmable Baby Orangutan and Orangutan SVP robot controllers. The inexpensive qik 2s9v1 allows variable speed and direction control of two small, brushed DC motors using a simple serial interface; the Orangutans combine a programmable Atmel AVR microcontroller and dual motor driver all in a single package and make interfacing with the motor drivers simple when you use our Pololu AVR library. We also carry a number of basic motor drivers suitable for use with these motors, including the DRV8833 dual motor driver carrier, the DRV8835 dual motor driver carrier, and the TB6612FNG dual motor driver carrier.



Pololu qik 2s9v1 dual serial motor
controller.



Baby Orangutan B-48/B-168/B-
328.



DRV8835 dual motor driver
carrier.

We also incorporate these motors into some of our products, including our 3pi robot and Zumo robot:



Pololu 3pi robot.



Assembled Zumo robot with a Zumo Shield, Arduino Uno, and Zumo blade.

Selecting the Right Gearmotor

We offer a wide selection of metal gearmotors that offer different combinations of speed and torque. Our metal gearmotor comparison table can help you find the motor that best meets your project's requirements.



Some of the Pololu metal gearmotors.

[Documentation on producer website.](http://www.pololu.com)