

**MULTI-RANGE
ANALOG TIMER** **PM4S
Timers**



RoHS Directive compatibility information
<http://www.nais-e.com/>

Features

1. Economic pricing that promptly reflects market demands

Remarkable economic pricing is implemented in pursuit of cost performance.

2. Output contacts switchable between timed out 2C and timed out 1C/Instantaneous 1C

The timed out 1C/Instantaneous 1C output contact enables the efficient addition of self-maintenance circuits.

3. 4 different time ranges selectable on a single unit

Five types of timers cover the full range of time settings from 1 second to 30 hours.

4. Equipped with zero-setting instantaneous output

Set the dial all the way to "0" for instantaneous operation, so circuit testing can be easily accomplished.

5. Compliant with UL, c-UL and CE.

Product types

Type	//////	Contact arrangement	Time range	Operating voltage	Part No.
PM4S Multi-range Timer A type	Power ON-delay	T.D.: Timed-out 2C INST.: Timed-out 1C Instantaneous 1C (Selected by front switch)	1s/10s/1min/10min (4 time ranges selectable)	100 to 120V AC	PM4S-A2C10M-AC120V
				200 to 240V AC	PM4S-A2C10M-AC240V
				12V DC	PM4S-A2C10M-DC12V
				24V DC	PM4S-A2C10M-DC24V
PM4S Multi-range Timer B type			3s/30s/3min/30min (4 time ranges selectable)	100 to 120V AC	PM4S-A2C30M-AC120V
				200 to 240V AC	PM4S-A2C30M-AC240V
				12V DC	PM4S-A2C30M-DC12V
				24V DC	PM4S-A2C30M-DC24V
PM4S Multi-range Timer C type			6s/60s/6min/60min (4 time ranges selectable)	100 to 120V AC	PM4S-A2C60M-AC120V
				200 to 240V AC	PM4S-A2C60M-AC240V
				12V DC	PM4S-A2C60M-DC12V
				24V DC	PM4S-A2C60M-DC24V
PM4S Multi-range Timer D type	1min/10min/1h/10h (4 time ranges selectable)	100 to 120V AC	PM4S-A2C10H-AC120V		
		200 to 240V AC	PM4S-A2C10H-AC240V		
		12V DC	PM4S-A2C10H-DC12V		
		24V DC	PM4S-A2C10H-DC24V		
PM4S Multi-range Timer E type	3min/30min/3h/30h (4 time ranges selectable)	100 to 120V AC	PM4S-A2C30H-AC120V		
		200 to 240V AC	PM4S-A2C30H-AC240V		
		12V DC	PM4S-A2C30H-DC12V		
		24V DC	PM4S-A2C30H-DC24V		

Parts name

• The PM4S Multi-Range timer allows time units and output contacts to be selected via front switches.

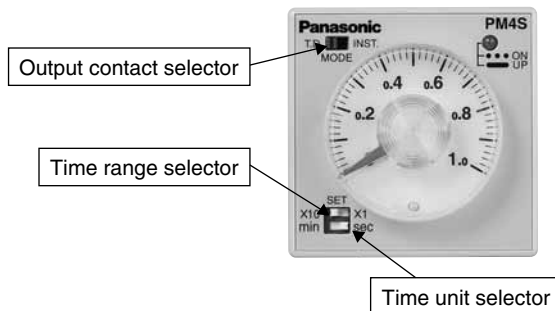

PM4S

Specifications

Item		Type	PM4S Multi-range Timer					
Rating	Rated operating voltage		100 to 120V AC		200 to 240V AC	12V DC	24V DC	
	Rated frequency		50/60 Hz				—	
	Rated power consumption		Approx. 3.0VA/3.6VA (at 100V AC) Approx. 4.5VA/5.25VA (at 120V AC)	Approx. 5.6VA/6.8VA (at 200V AC) Approx. 7.5VA/9.8VA (at 240V AC)	Approx. 1.3W		Approx. 1.7W	
	Output rating		5A 250V AC (resistive load)					
	Operating mode		Power ON-delay					
	Time range	A type		1s/10s/1min/10min (4 time ranges selectable)				
		B type		3s/30s/3min/30min (4 time ranges selectable)				
C type			6s/60s/6min/60min (4 time ranges selectable)					
D type			1min/10min/1h/10h (4 time ranges selectable)					
E type			3min/30min/3h/30h (4 time ranges selectable)					
Time accuracy Note)	Operating time fluctuation		±1% (power off time change at the range of 0.1s to 1h)					
	Setting error		±5% (Full-scale value)					
	Voltage error		±1% (at the operating voltage changes between 85 to 110%)					
	Temperature error		±2% (at 20°C ambient temp. at the range of -10 to +50°C +14 to +122°F)					
Contact	Contact arrangement		T.D.: Timed-out 2 Form C INST.: Timed-out 1 Form C, instantaneous 1 Form C (Selected by front switch)					
	Contact resistance (Initial value)		Max. 100mΩ (at 1A 6V DC)					
	Contact material		Silver alloy					
Life	Mechanical (contact)		Min. 10 ⁷					
	Electrical (contact)		Min. 10 ⁵ (at rated control capacity)					
Electrical function	Allowable operating voltage range		85 to 110% of rated operating voltage					
	Insulation resistance (Initial value)		Min. 100MΩ	Between live and dead metal parts Between input and output Between contacts of different poles Between contacts of same pole			(At 500V DC)	
	Breakdown voltage (Initial value)		2,000Vrms for 1 min Between live and dead metal parts 2,000Vrms for 1 min Between input and output 2,000Vrms for 1 min Between contacts of different poles 1,000Vrms for 1 min Between contacts of same pole					
	Min. power off time		100 ms					
	Max. temperature rise		55°C 131°F					
Mechanical function	Vibration resistance	Functional	10 to 55Hz: 1 cycle/min double amplitude of 0.25mm (10min on 3 axes)					
		Destructive	10 to 55Hz: 1 cycle/min double amplitude of 0.375mm (1h on 3 axes)					
	Shock resistance	Functional	Min. 98m/s ² (4 times on 3 axes)					
		Destructive	Min. 980m/s ² (5 times on 3 axes)					
Operating condition	Ambient temperature		-10 to +50°C +14 to +122°F					
	Ambient humidity		30 to 85%RH (non-condensing)					
	Atmospheric pressure		860 to 1,060hPa					
	Ripple factor (DC type)		20%					
Others	Weight		Approximately 110 g 3.880 oz					

Notes) 1. Unless otherwise specified, the measurement conditions at the maximum scale time standard are specified to be the rated operating voltage (within 5% ripple factor for DC), 20°C 68°F ambient temperature, and 1s power off time.

2. For the 1s range, the tolerance for each specification becomes ±10ms.

Applicable standard

Safety standard	EN61812-1	Pollution Degree 2/Overvoltage Category III
EMC	(EMI)EN61000-6-4 Radiation interference electric field strength Noise terminal voltage	EN55011 Group1 ClassA EN55011 Group1 ClassA
	(EMS)EN61000-6-2 Static discharge immunity	EN61000-4-2 4 kV contact 8 kV air
	RF electromagnetic field immunity	EN61000-4-3 10 V/m AM modulation (80 MHz to 1 GHz) 10 V/m pulse modulation (895 MHz to 905 MHz)
	EFT/B immunity	EN61000-4-4 2 kV (power supply line)
	Surge immunity	EN61000-4-5 1 kV (power line)
	Conductivity noise immunity	EN61000-4-6 10 V/m AM modulation (0.15 MHz to 80 MHz)
	Power frequency magnetic field immunity	EN61000-4-8 30 A/m (50 Hz)
	Voltage dip/Instantaneous stop/Voltage fluctuation immunity	EN61000-4-11 10 ms, 30% (rated voltage) 100 ms, 60% (rated voltage) 1,000 ms, 60% (rated voltage) 5,000 ms, 95% (rated voltage)

Dimension (Unit: mm inch) Tolerance: $\pm 0.5 \pm .020$

• **Surface mount dimensions**

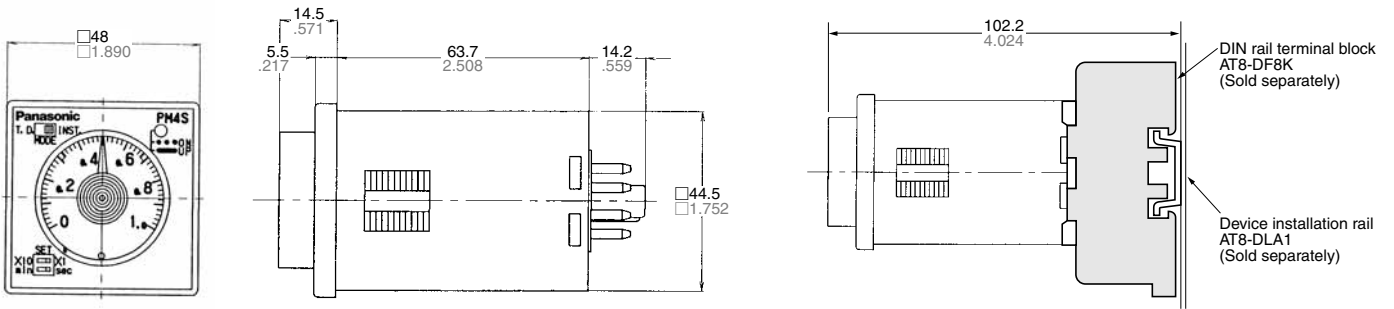

• **Panel mount dimensions (with mounting frame)**

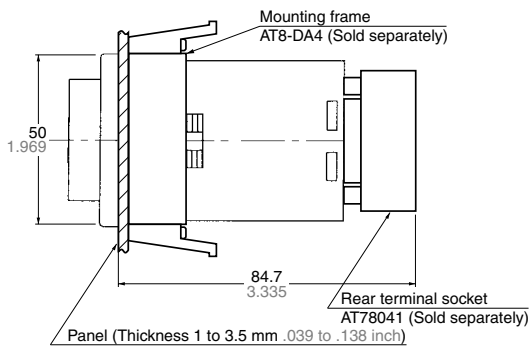

• **Panel cut out dimensions**

Standard cut out dimensions are shown below.
Use mounting frame (AT8-DA4) and rubber gasket (ATC18002).

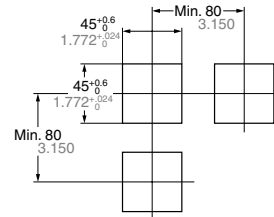

• **Adjacent mounting**

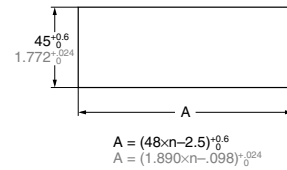

• **Terminal layouts and wiring diagrams**

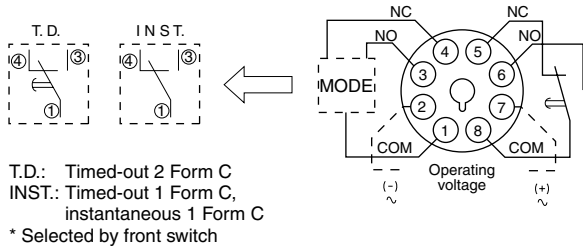

Notes:

- Operating voltage signs in parentheses () indicate the polarity of the DC type.
- is a time delay contact.
- is an instantaneous contact.

Operation mode

1. **T.D. mode**

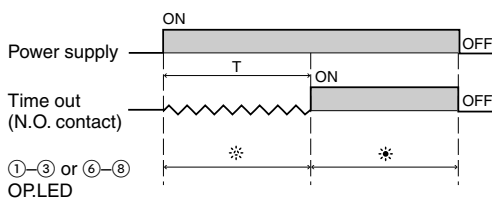

2. **INST. mode**

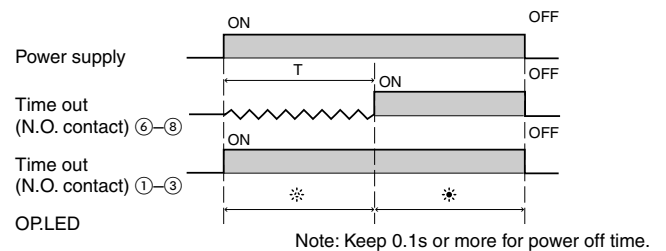

Precautions during usage

1. Avoid locations subject to flammable or corrosive gases, excessive dust, oil, vibrations, or excessive shocks.
2. Since the main-unit is made of polycarbonate resin, avoid contact with or use in environments containing methyl alcohol, benzene, thinners, and other organic solvents; and ammonia, caustic sodas, and other alkaline substances.
3. **Power supply superimposed surge protector**

Although a surge protector will withstand standard-waveform voltage with the values in the next table, anything above this will destroy the internal circuit. You should therefore use a surge absorber.

12 V DC 24 V DC	100 to 120 V AC 200 to 240 V AC
500 V	4,000 V

- Surge waveform
[$\pm(1.2 \times 50) \mu\text{s}$ uni-polar full wave voltage]

4. In order to maintain the characteristics, do not remove the timer case.
5. When installing the panel, use the ATA4811 mounting frame (Sold separately).
6. If you change the operating voltage, be sure not to allow leak current into the timer.
7. Avoid leaving the unit powered continuously. Leaving the unit powered up with output set to ON continuously for a long period of time (about 1 month or more) will wear out the electronic components. If you will be keeping it powered continuously, combine with a relay to create the circuit shown below:

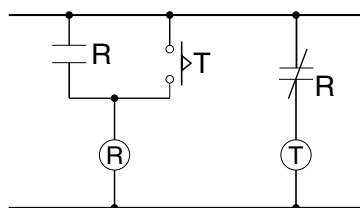

8. The timer setting dial should only be turned within the range indicated on the dial face. Turning it too far may break the stopper and cause damage to internal components.

Acquisition of CE marking

Please abide by the conditions below when using in applications that comply with EN61812-1.

1. Overvoltage category III, pollution level 2
2. The load connected to the output contact should have basic insulation. This timer is protected with basic insulation and can be double-insulated to meet EN/IEC requirements by using basic insulation on the load.

3. Please use a power supply that is protected by an overcurrent protection device which complies with the EN/IEC standard (example: 250 V 1 A fuse, etc.).
4. You must use a terminal socket or socket for the installation. Do not touch the terminals or other parts of the timer when it is powered. When installing or un-installing, make sure that no voltage is being applied to any of the terminals.

5. Do not use this timer as a safety circuit. For example when using a timer in a heater circuit, etc., provide a protection circuit on the machine side.