



PKT / PKS / PKH SERIES - CAM SWITCHES

- Complete range of cam switches for control, instrumentation and motor starting applications.
- Available for currents from 6 A to 200 A.
- Quick and easy installation.
- Compact size with many switching programs.
- Multi pole design.
- Long distance visibility.
- Touch-proof terminals with IP20 protection.

TYPES:

PKT1, PKS1, PKH1 - CHANGEOVER

PKT2, PKS2, PKH2 - MULTI-STEP

PKT3, PKS3, PKH3 - ISOLATOR

PKT4 - SELECTOR

APPLICATION EXAMPLES

Switching on the (emergency) power supply.

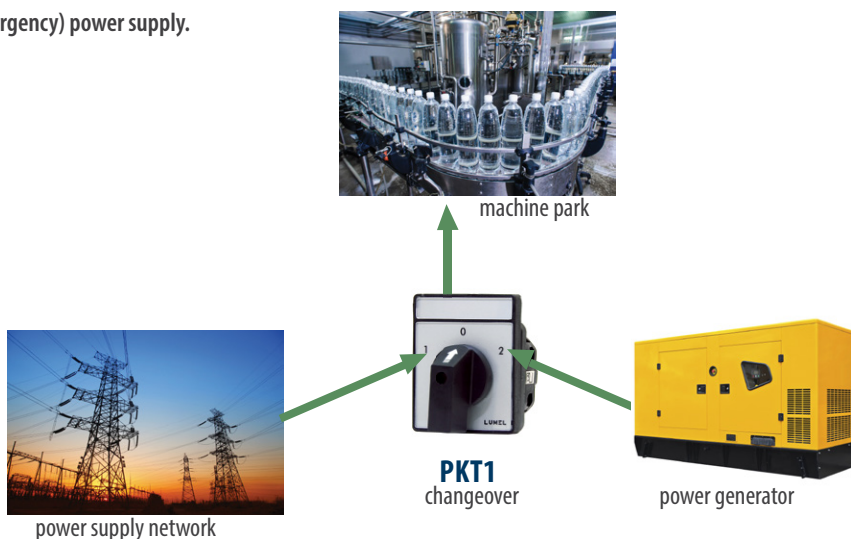

Measurement of phase and phase-to-phase voltage using only one voltmeter.

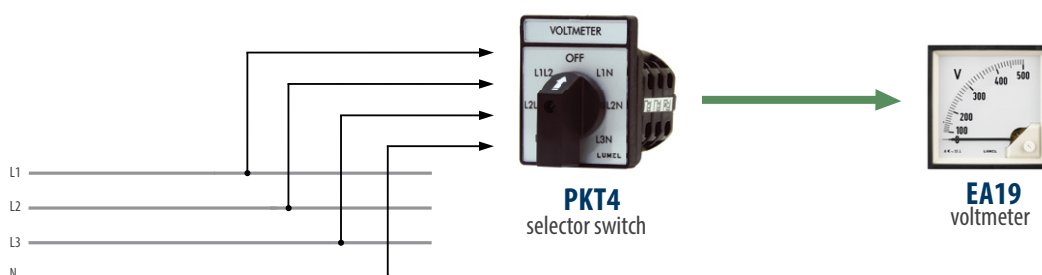

PKT1 / PKT2 / PKT3 / PKT4

- CAM SWITCHES

EXTERNAL DIMENSIONS

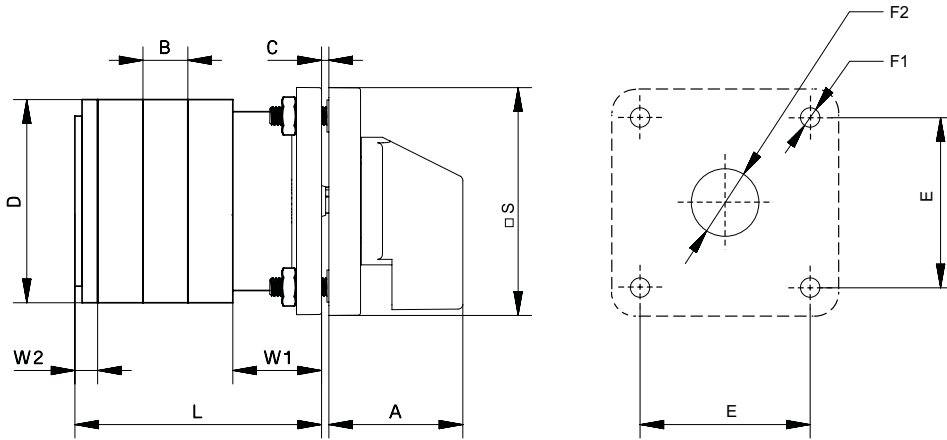

$L = \text{No. of Stages of Prog} \times B + W1 + W2$

Drilling plane

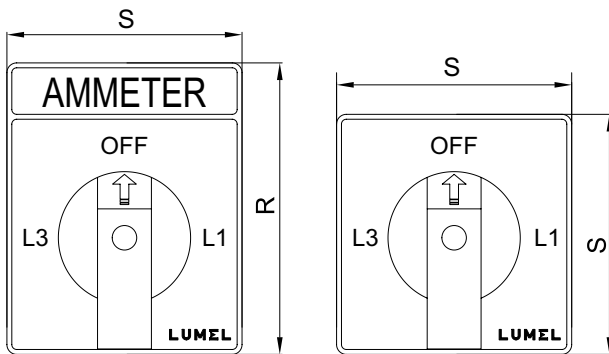

Type	A	B	C _(max)	D	E	F1	F2	R	S	W1	W2
6 A	29 mm	9.7 mm	4 mm	32 mm	36 mm	4 mm	8 mm	48 mm	48 mm	13 mm	7 mm
10 A	29 mm	9.5 mm	4 mm	43 mm	36 mm	4 mm	7 mm	60 mm	48 mm	19 mm	5 mm
16 A	29 mm	9.5 mm	4 mm	43 mm	36 mm	4 mm	7 mm	60 mm	48 mm	19 mm	5 mm
20 A	29 mm	9.5 mm	4 mm	43 mm	36 mm	4 mm	7 mm	60 mm	48 mm	19 mm	5 mm
25 A	34 mm	14.3 mm	4 mm	53 mm	48 mm	4 mm	12 mm	64 mm	64 mm	24 mm	6.2 mm
32 A	34 mm	14.3 mm	4 mm	53 mm	48 mm	4 mm	12 mm	64 mm	64 mm	24 mm	6.2 mm
40 A	34 mm	14.3 mm	4 mm	53 mm	48 mm	4 mm	12 mm	64 mm	64 mm	24 mm	6.2 mm
63 A	34 mm	14.3 mm	4 mm	53 mm	48 mm	4 mm	12 mm	64 mm	64 mm	24 mm	6.2 mm
100 A	49 mm	29 mm	4 mm	88 mm	68 mm	5.5 mm	18 mm	88 mm	88 mm	27 mm	7 mm
200 A	49 mm	29 mm	4 mm	88 mm	68 mm	5.5 mm	18 mm	88 mm	88 mm	27 mm	7 mm

INSTALLATION

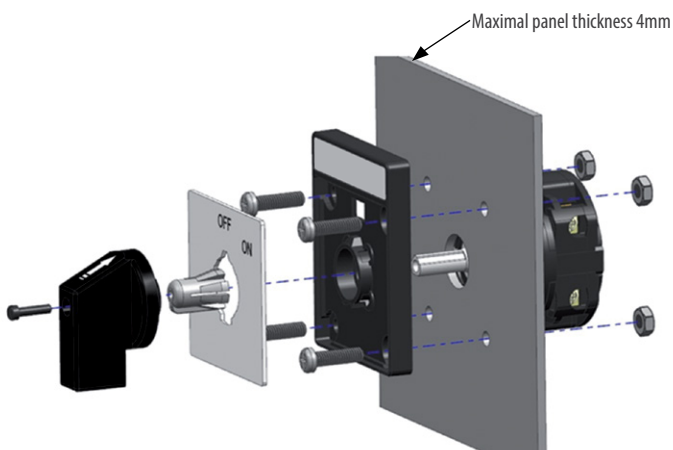

AC DUTY RATINGS

Class	Application
AC-1	Non-Inductive or slightly inductive loads ($\cos\phi \geq 0,95$); Resistance furnaces
AC-3	Squirrel-cage motors: starting switching off motors during running
AC-15	Control of AC electromagnetic loads
AC-21-A	Switching of resistive loads, including moderate overloads (frequent switching)
AC-23-A	Switching of motor loads or other highly inductive loads (frequent switching)

PKT1 / PKT2 / PKT3 / PKT4

- CAM SWITCHES

TECHNICAL DATA

PARAMETERS		UNIT	6 A	10 A	16 A	20 A	25 A	32 A	40 A	63 A	100 A	200 A
Rated operational voltage (Ue)		V	440	440	690	690	690	690	690	690	690	690
Rated insulation voltage (Ui)		V	440	440	690	690	690	690	690	690	690	690
Rated uninterupted current (Ith)		A	8	12	20	25	25	32	40	63	100	200
Rated short time withstand current (Icw)		A	72	120	192*	240*	300	384	480	756	1200	2400
Rated impulse withstand voltage (Uimp)		kV	4	4	4	4	6	6	6	6	6	6
Rated Fuse short circuit current		kA	3	3	5	5	10	10	10	10	15	25
Fuse size (Type gG/ gM)		A	6	10	16	20	25	32	50	63	100	200
The power of the receiver in terms of use												
AC23A 3 phase	220-240V	kW	1.1	1.8	3	3.7	4.7	5.5	7.5	11	22	22
	380-440V	kW	1.8	3	5.5	7.5	7.5	11	15	18.5	37	37
	500V	kW	-	-	5.5	7.5	11	15	18.5	22	45	45
	660-690V	kW	-	-	5.5	7.5	11	15	18.5	22	45	45
AC23A 1 phase	110V	kW	0.25	0.37	0.55	0.75	1.5	2.2	2.2	3	-	-
	220-240V	kW	0.5	0.75	1.5	2.2	3	3.7	5.5	7.5	-	-
	380-440V	kW	0.75	1.1	2.2	3.7	5.5	7.5	7.5	11	-	-
AC3 3 phase	220-240V	kW	1.1	1.5	3	3	4.7	5.5	7.5	11	22	22
	380-440V	kW	1.8	2.2	5.5	5.5	7.5	11	15	18.5	37	37
	500V	kW	-	-	5.5	5.5	11	15	18.5	22	45	45
	600-690V	kW	-	-	5.5	5.5	11	15	18.5	22	45	45
AC3 1 phase	110V	kW	0.25	0.3	0.55	0.6	1.5	2.2	2.2	3	-	-
	220-240V	kW	0.5	0.55	1.5	2.2	3	3.7	5.5	7.5	-	-
	380-440V	kW	0.75	0.75	2.5	3	5.5	7.5	7.5	11	-	-
	AC21A/AC1	A	6	10	16	20	25	32	40	63	100	200
AC15	220-240V	A	2	2.5	5	5	8	14	16	16	20	-
	380-440V	A	1	1.5	4	4	5	6	7	7	10	-
Terminal cross-section												
Single / Multiple	Min	mm ²	0.7	0.7	1.5	1.5	2.5	2.5	4	4	10	10
	Max	mm ²	1.5	1.5	4	4	4	6	10	16	35	70
Fine strand with sleeve	Min	mm ²	0.7	0.7	1	1	1.5	1.5	2.5	2.5	10	10
	Max	mm ²	1.5	1.5	2.5	2.5	4	4	6	16	35	50
Terminal screw		metric	M3	M3	M3	M3	M4	M4	M4	M4	M10	M10
Terminal tightening torque		Nm	0.8	0.8	0.8	0.8	1.2	1.2	1.2	1.2	2.5	2.5

* Rated short time withstand current (0.5s- current)

RATED OPERATING CONDITIONS

Frequency	50/60 Hz	
Operating temperature	-25°C...60°C	
Storage temperature	-40°C...80°C	
Installation category	III	
Altitude a.s.l.	2000 m	
Protection grade	IP50 from frontal side	IP20 from terminal side
Standards	IEC 60947-1, IEC 60947-3, IEC 60947-5	

SWITCH LIFE

Mechanical Life	100 000 operations at 300 cycles/hr	
Electrical Life	10 000 operations at 100% rated duty at 120 cycles/hr	
Contacts	double break	type AgNi
	double break	type AgCdO

PKT1/ PKS1/ PKH1 SERIES

- CHANGEOVERS

WIRING DIAGRAMS AND CODING

CHANGEOVERS PKT1, PKS1, PKH1

Ordering code PKT1- **60L** 02OF _00
 PKS1- **60L** 02OF _00
 PKH1- **60L** 02OF _00

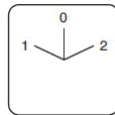

Changeover PKT1- PKS1- PKH1-		60L	02OF			00
Rated current:						
6 A		A				
10 A	PKT1	B				
16 A		C				
25 A		D				
32 A	PKS1	E				
40 A		F				
63 A		G				
100 A	PKH1	H				
200 A		I				
Pole:						
1 pole			1			
2 poles			2			
....			...			
6 poles			6			
Front plate colour:						
silver background and black knob						A
yellow background and red knob						Y
Acceptance tests:						
without additional quality requirements						0
with an extra quality inspection certificate						1

ITEMS AVAILABLE FROM OUR STOCK:

PKT1-C60L1020FA000

- Changeover 16A, angle 60°, rotation angle <360°, 1 pole, 2 ways, with OFF, rectangular knob, silver background, black knob

PKT1-C60L1020FY000

- Changeover 16A, angle 60°, rotation angle <360°, 1 pole, 2 ways, with OFF, rectangular knob, yellow background, red knob

Description	PKT1			PKS1			PKH1		
	6A	10A	16A	25A	32A	40A	63A	100A	200A
Stage number									
1-polar 2-way + OFF	1	1	1	1	1	1	1	1	1
2-polar 2-way + OFF	2	2	2	2	2	2	2	2	2
3-polar 2-way + OFF	3	3	3	3	3	3	3	3	3
4-polar 2-way + OFF	4	4	4	4	4	4	4	4	4
5-polar 2-way + OFF	5	5	5	5	5	5	5	5	5
6-polar 2-way + OFF	6	6	6	6	6	6	6	6	6

OUTPUT SIDE	1A	2A	1B	2B	1C	2C	1D	2D	1E	2E	1F	2F
INPUT SIDE	LA	LA	LB	LB	LC	LC	LD	LD	LE	LE	LF	LF
POLES	1		2		3		4		5		6	
0												
1	X		X		X		X		X		X	
2		X		X		X		X		X		X

Ordering code PKT1- **90T** 02OF _00
 PKS1- **90T** 02OF _00
 PKH1- **90T** 02OF _00

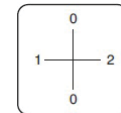

Changeover PKT1- PKS1- PKH1-		90T	02OF			00
Rated current:						
6 A		A				
10 A	PKT1	B				
16 A		C				
25 A		D				
32 A	PKS1	E				
40 A		F				
63 A		G				
100 A	PKH1	H				
200 A		I				
Pole:						
1 pole			1			
2 poles			2			
....			...			
6 poles			6			
Front plate colour:						
silver background and black knob						A
yellow background and red knob						Y
Acceptance tests:						
without additional quality requirements						0
with an extra quality inspection certificate						1

Description	PKT1			PKS1			PKH1		
	6A	10A	16A	25A	32A	40A	63A	100A	200A
Stage number									
1-polar 2-way + OFF	1	1	1	1	1	1	1	1	1
2-polar 2-way + OFF	2	2	2	2	2	2	2	2	2
3-polar 2-way + OFF	3	3	3	3	3	3	3	3	3
4-polar 2-way + OFF	4	4	4	4	4	4	4	4	4
5-polar 2-way + OFF	5	5	5	5	5	5	5	5	5
6-polar 2-way + OFF	6	6	6	6	6	6	6	6	6

OUTPUT SIDE	1A	2A	1B	2B	1C	2C	1D	2D	1E	2E	1F	2F
INPUT SIDE	LA	LA	LB	LB	LC	LC	LD	LD	LE	LE	LF	LF
POLES	1		2		3		4		5		6	
0												
1	X		X		X		X		X		X	
2		X		X		X		X		X		X

PKT1/ PKS1/ PKH1 SERIES

- CHANGEOVERS

WIRING DIAGRAMS AND CODING

CHANGEOVERS PKT1, PKS1, PKH1

Ordering code PKT1- 90T **02WF** - 00
 PKS1- 90T **02WF** - 00
 PKH1- 90T **02WF** - 00

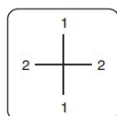

Changeover PKT1- PKS1- PKH1-		90T	02WF		00
Rated current:					
6 A		A			
10 A	PKT1	B			
16 A		C			
25 A		D			
32 A	PKS1	E			
40 A		F			
63 A		G			
100 A	PKH1	H			
200 A		I			
Pole:					
1 pole			1		
2 poles			2		
....			...		
6 poles			6		
Front plate colour:					
silver background and black knob				A	
yellow background and red knob				Y	
Acceptance tests:					
without additional quality requirements				0	
with an extra quality inspection certificate				1	

Ordering code PKT1- 90T **03OF** - 00
 PKS1- 90T **03OF** - 00
 PKH1- 90T **03OF** - 00

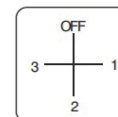

Changeover PKT1- PKS1- PKH1-		90T	03OF		00
Rated current:					
6 A		A			
10 A	PKT1	B			
16 A		C			
25 A		D			
32 A	PKS1	E			
40 A		F			
63 A		G			
100 A	PKH1	H			
200 A		I			
Pole:					
1 pole			1		
2 poles			2		
3 poles			3		
Front plate colour:					
silver background and black knob				A	
yellow background and red knob				Y	
Acceptance tests:					
without additional quality requirements				0	
with an extra quality inspection certificate				1	

Description	PKT1			PKS1				PKH1	
	6A	10A	16A	25A	32A	40A	63A	100A	200A
	Stage number								
1-polar 2-way	1	1	1	1	1	1	1	1	1
2-polar 2-way	2	2	2	2	2	2	2	2	2
3-polar 2-way	3	3	3	3	3	3	3	3	3
4-polar 2-way	4	4	4	4	4	4	4	4	4
5-polar 2-way	5	5	5	5	5	5	5	5	5
6-polar 2-way	6	6	6	6	6	6	6	6	6

Description	PKT1			PKS1				PKH1	
	6A	10A	16A	25A	32A	40A	63A	100A	200A
	Stage number								
1-polar 3-way + OFF	2	2	2	2	2	2	2	2	2
2-polar 3-way + OFF	3	3	3	3	3	3	3	3	3
3-polar 3-way + OFF	5	5	5	5	5	5	5	5	5

OUTPUT SIDE	1A	2A	1B	2B	1C	2C	1D	2D	1E	2E	1F	2F
INPUT SIDE	LA	LA	LB	LB	LC	LC	LD	LD	LE	LE	LF	LF
POLES	1		2		3		4		5		6	
0												
1	X		X		X		X		X		X	
2		X		X		X		X		X		X

OUTPUT SIDE	1A	2A	1B	3A	2B	2B	1C	2C	3C
INPUT SIDE	LA	LA	LB	LA	LB	LB	LC	LC	LC
POLES	1		2	1	2		3		3
OFF									
1	X		X				X		
2		X			X			X	
3				X		X			X

PKT1/ PKS1/ PKH1 SERIES

- CHANGEOVERS

WIRING DIAGRAMS AND CODING

CHANGEOVERS PKT1, PKS1, PKH1

CODING OF PKT1, PKS1, PKH1 SERIES

Changeover PKT1- PKS1- PKH1-		-	-	0	-	-	-	-	F	-	-	00
Rated current:												
6 A		A										
10 A	PKT1	B										
16 A		C										
25 A		D										
32 A	PKS1	E										
40 A		F										
63 A		G										
100 A		H										
200 A	PKH1	I										
Angle:												
60°		6										
90°		9										
		0										
Rotation angle:												
360°		T										
less than 360° *		L										
Pole:												
1 pole		1										
2 poles		2										
....		...										
6 poles		6										
No. of ways:												
2 ways		02										
3 ways		03										
OFF way:												
without OFF**		W										
with OFF		O										
		F										
Front plate colour:												
silver background and black knob		A										
yellow background and red knob		Y										
Acceptance tests:												
without additional quality requirements		0										
with an extra quality inspection certificate		1										
Version:												
standard		00										
custom-made***		XX										

* - only for rotation angle 60°

** - only for rotation angle 90°

*** - only after agreeing with the manufacturer

PKT2, PKS2, PKH2 SERIES

- MULTI-STEPS

WIRING DIAGRAMS AND CODING

MULTI-STEPS PKT2, PKS2, PKH2

Ordering code PKT2- 90T_03OF_00
 PKS2- 90T_03OF_00
 PKH2- 90T_03OF_00

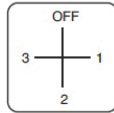

Ordering code PKT2- 60L_04OF_00
 PKS2- 60L_04OF_00
 PKH2- 60L_04OF_00

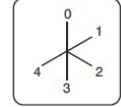

Multi-step PKT2- PKS2- PKH2-		90T	03	O	F	00
Rated current:						
6 A	A					
10 A	PKT2	B				
16 A		C				
25 A		D				
32 A	PKS2	E				
40 A		F				
63 A		G				
100 A	PKH2	H				
200 A		I				
Pole:						
1 pole			1			
2 poles			2			
3 poles			3			
4 poles			4			
Front plate colour:						
silver background and black knob		A				
yellow background and red knob		Y				
Acceptance tests:						
without additional quality requirements		0				
with an extra quality inspection certificate		1				

Multi-step PKT2- PKS2- PKH2-		60L	04	O	F	00
Rated current:						
6 A	A					
10 A	PKT2	B				
16 A		C				
25 A		D				
32 A	PKS2	E				
40 A		F				
63 A		G				
100 A	PKH2	H				
200 A		I				
Pole:						
1 pole			1			
2 poles			2			
3 poles			3			
Front plate colour:						
silver background and black knob		A				
yellow background and red knob		Y				
Acceptance tests:						
without additional quality requirements		0				
with an extra quality inspection certificate		1				

Description	PKT2			PKS2				PKH2	
	6A	10A	16A	25A	32A	40A	63A	100A	200A
	Stage number								
1-polar 3-way + OFF	2	2	2	2	2	2	2	2	2
2-polar 3-way + OFF	3	3	3	3	3	3	3	3	3
3-polar 3-way + OFF	5	5	5	5	5	5	5	5	5
4-polar 3-way + OFF	6	6	6	6	6	6	6	6	6

ITEMS AVAILABLE FROM OUR STOCK:

PKT2-C60L1040FA000

- Multi-step 16A, angle 60°, rotation angle <360°, 1 pole, 4 ways, with OFF, rectangular knob, silver background, black knob

PKT2-C60L1040FY000

- Multi-step 16A, angle 60°, rotation angle <360°, 1 pole, 4 ways, with OFF, rectangular knob, yellow background, red knob

Description	PKT2			PKS2				PKH2	
	6A	10A	16A	25A	32A	40A	63A	100A	200A
	Stage number								
1-polar 4-way + OFF	2	2	2	2	2	2	2	2	2
2-polar 4-way + OFF	4	4	4	4	4	4	4	4	4
3-polar 4-way + OFF	6	6	6	6	6	6	6	6	6

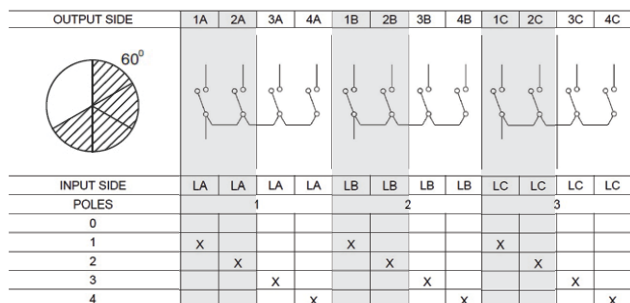
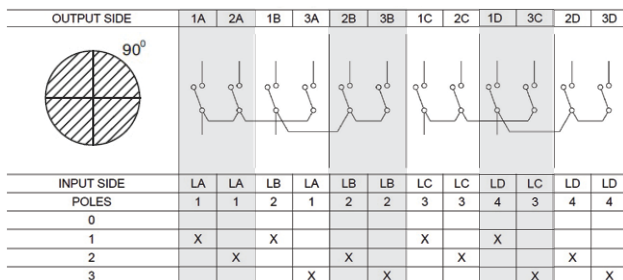

PKT2, PKS2, PKH2 SERIES

- MULTI-STEPS

WIRING DIAGRAMS AND CODING

MULTI-STEPS PKT2, PKS2, PKH2

Ordering code PKT2- 60T_05OF_00
 PKS2- 60T_05OF_00
 PKH2- 60T_05OF_00

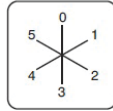

Multi-step PKT2- PKS2- PKH2-		60T	05	O	F	00
Rated current:						
6 A	A					
10 A	PKT2	B				
16 A		C				
25 A		D				
32 A	PKS2	E				
40 A		F				
63 A		G				
100 A	PKH2	H				
200 A		I				
Pole:						
1 pole			1			
2 poles			2			
Front plate colour:						
silver background and black knob		A				
yellow background and red knob		Y				
Acceptance tests:						
without additional quality requirements						0
with an extra quality inspection certificate						1

Ordering code PKT2- 40L_06OF_00
 PKS2- 40L_06OF_00

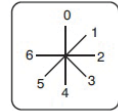

Multi-step PKT2- PKS2-		40L	06	O	F	00
Rated current:						
6 A	A					
10 A	PKT2	B				
16 A		C				
25 A		D				
32 A	PKS2	E				
40 A		F				
63 A		G				
Pole:						
1 pole			1			
2 poles			2			
Front plate colour:						
silver background and black knob		A				
yellow background and red knob		Y				
Acceptance tests:						
without additional quality requirements						0
with an extra quality inspection certificate						1

Description	PKT2			PKS2				PKH2	
	6A	10A	16A	25A	32A	40A	63A	100A	200A
	Stage number								
1-polar 5-way + OFF	3	3	3	3	3	3	3	3	3
2-polar 5-way + OFF	5	5	5	5	5	5	5	5	5

Description	PKT2			PKS2			
	6A	10A	16A	25A	32A	40A	63A
	Stage number						
1-polar 6-way + OFF	3	3	3	3	3	3	3
2-polar 6-way + OFF	6	6	6	6	6	6	6

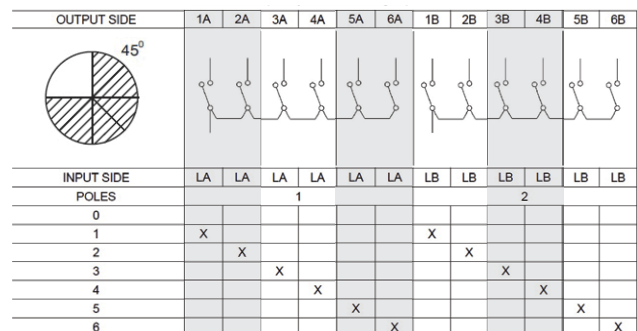
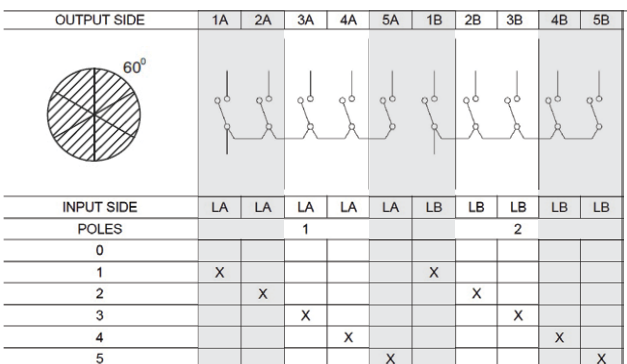

PKT2, PKS2, PKH2 SERIES

- MULTI-STEPS

WIRING DIAGRAMS AND CODING





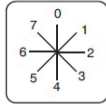

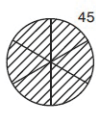

MULTI-STEPS PKT2, PKS2, PKH2

Ordering code PKT2- **40T107**OF __ 00
PKS2- **40T107**OF __ 00



Multi-step PKT2- PKS2- PKH2-	40T107OF	__	__	00
Rated current:				
6 A	A			
10 A	PKT2	B		
16 A	C			
25 A	D			
32 A	E			
40 A	PKS2	F		
63 A	G			
Front plate colour:				
silver background and black knob		A		
yellow background and red knob		Y		
Acceptance tests:				
without additional quality requirements				0
with an extra quality inspection certificate				1

Description	PKT2			PKS2			
	6A	10A	16A	25A	32A	40A	63A
	Stage number						
1-polar 7-way + OFF	4	4	4	4	4	4	4





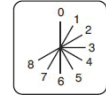

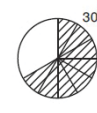

OUTPUT SIDE	1A	2A	3A	4A	5A	6A	7A
							
INPUT SIDE	LA	LA	LA	LA	LA	LA	LA
0							
1	X						
2		X					
3			X				
4				X			
5					X		
6						X	
7							X

Ordering code PKT2- **30L108**OF __ 00



Multi-step PKT2-	30L108OF	__	__	00
Rated current:				
6 A	A			
10 A	PKT2	B		
16 A	C			
Front plate colour:				
silver background and black knob		A		
yellow background and red knob		Y		
Acceptance tests:				
without additional quality requirements				0
with an extra quality inspection certificate				1

Description	PKT2		
	6A	10A	16A
	Stage number		
1-polar 8-way + OFF	4	4	4

OUTPUT SIDE	1A	2A	3A	4A	5A	6A	7A	8A
								
INPUT SIDE	LA	LA	LA	LA	LA	LA	LA	LA
0								
1	X							
2		X						
3			X					
4				X				
5					X			
6						X		
7							X	
8								X

PKT2, PKS2, PKH2 SERIES

- MULTI-STEPS

WIRING DIAGRAMS AND CODING

MULTI-STEPS PKT2, PKS2, PKH2

Ordering code PKT2-30T109OF-00

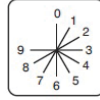

Multi-step PKT2-		30T109OF	-	-	00
Rated current:					
6 A		A			
10 A	PKT2	B			
16 A		C			
Front plate colour:					
silver background and black knob			A		
yellow background and red knob			Y		
Acceptance tests:					
without additional quality requirements				0	
with an extra quality inspection certificate				1	

Description	PKT2		
	6A	10A	16A
	Stage number		
1-polar 9-way + OFF	5	5	5

OUTPUT SIDE	1A	2A	3A	4A	5A	6A	7A	8A	9A
INPUT SIDE	LA	LA	LA	LA	LA	LA	LA	LA	LA
0									
1	X								
2		X							
3			X						
4				X					
5					X				
6						X			
7							X		
8								X	
9									X

Ordering code PKT2-30T110OF-00

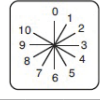

Multi-step PKT2-		30T110OF	-	-	00
Rated current:					
6 A		A			
10 A	PKT2	B			
16 A		C			
Front plate colour:					
silver background and black knob			A		
yellow background and red knob			Y		
Acceptance tests:					
without additional quality requirements				0	
with an extra quality inspection certificate				1	

Description	PKT2		
	6A	10A	16A
	Stage number		
1-polar 10-way + OFF	5	5	5

OUTPUT SIDE	1A	2A	3A	4A	5A	6A	7A	8A	9A	10A
INPUT SIDE	LA	LA	LA	LA	LA	LA	LA	LA	LA	LA
0										
1	X									
2		X								
3			X							
4				X						
5					X					
6						X				
7							X			
8								X		
9									X	
10										X

Ordering code PKT2-30T111OF-00

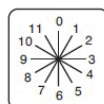

Multi-step PKT2-		30T111OF	-	-	00
Rated current:					
6 A		A			
10 A		B			
16 A		C			
Front plate colour:					
silver background and black knob			A		
yellow background and red knob			Y		
Acceptance tests:					
without additional quality requirements				0	
with an extra quality inspection certificate				1	

Description	PKT2		
	6A	10A	16A
	Stage number		
1-polar 11-way + OFF	6	6	6

OUTPUT SIDE	1A	2A	3A	4A	5A	6A	7A	8A	9A	10A	11A
INPUT SIDE	LA	LA	LA	LA	LA	LA	LA	LA	LA	LA	LA
0											
1	X										
2		X									
3			X								
4				X							
5					X						
6						X					
7							X				
8								X			
9									X		
10										X	
11											X

PKT2, PKS2, PKH2 SERIES

- MULTI-STEPS

WIRING DIAGRAMS AND CODING

MULTI-STEPS PKT2, PKS2, PKH2

Ordering code PKT2- 60L_03WF_00
PKS2- 60L_03WF_00
PKH2- 60L_03WF_00

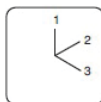

Multi-step PKT2- PKS2- PKH2-		60L	03WF	00
Rated current:				
6 A		A		
10 A	PKT2	B		
16 A		C		
25 A		D		
32 A		E		
40 A	PKS2	F		
63 A		G		
100 A		H		
200 A	PKH2	I		
Pole:				
1 pole			1	
2 poles			2	
3 poles			3	
4 poles			4	
Front plate colour:				
silver background and black knob				A
yellow background and red knob				Y
Acceptance tests:				
without additional quality requirements				0
with an extra quality inspection certificate				1

Ordering code PKT2- 90T_04WF_00
PKS2- 90T_04WF_00
PKH2- 90T_04WF_00



Multi-step PKT2- PKS2- PKH2-		90T	04WF	00
Rated current:				
6 A		A		
10 A	PKT2	B		
16 A		C		
25 A		D		
32 A		E		
40 A	PKS2	F		
63 A		G		
100 A		H		
200 A	PKH2	I		
Pole:				
1 pole			1	
2 poles			2	
3 poles			3	
Front plate colour:				
silver background and black knob				A
yellow background and red knob				Y
Acceptance tests:				
without additional quality requirements				0
with an extra quality inspection certificate				1

Description	PKT2			PKS2				PKH2	
	6A	10A	16A	25A	32A	40A	63A	100A	200A
	Stage number								
1-polar 3-way without OFF	2	2	2	2	2	2	2	2	2
2-polar 3-way without OFF	3	3	3	3	3	3	3	3	3
3-polar 3-way without OFF	5	5	5	5	5	5	5	5	5
4-polar 3-way without OFF	6	6	6	6	6	6	6	6	6

Description	PKT2			PKS2				PKH2	
	6A	10A	16A	25A	32A	40A	63A	100A	200A
	Stage number								
1-polar 4-way without OFF	2	2	2	2	2	2	2	2	2
2-polar 4-way without OFF	4	4	4	4	4	4	4	4	4
3-polar 4-way without OFF	6	6	6	6	6	6	6	6	6

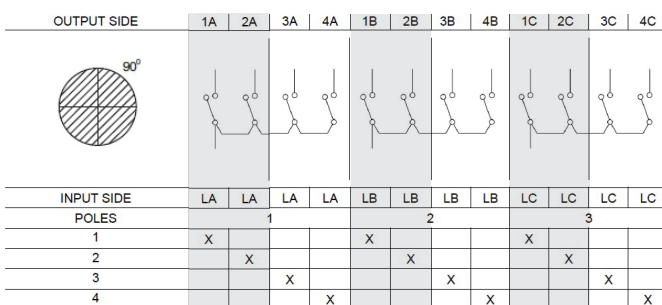
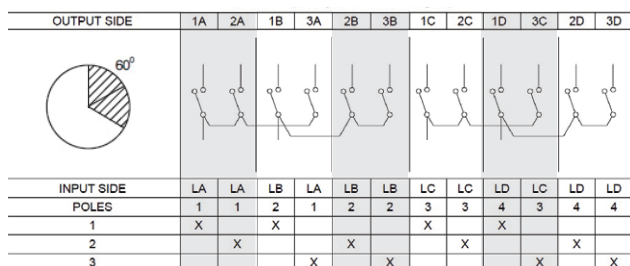

PKT2, PKS2, PKH2 SERIES

- MULTI-STEPS

WIRING DIAGRAMS AND CODING

MULTI-STEPS PKT2, PKS2, PKH2

Ordering code PKT2- 60L_05WF _00
PKS2- 60L_05WF _00
PKH2- 60L_05WF _00



Multi-step PKT2- PKS2- PKH2-		60L	05WF	00	
Rated current:					
6 A		A			
10 A	PKT2	B			
16 A		C			
25 A		D			
32 A	PKS2	E			
40 A		F			
63 A		G			
100 A	PKH2	H			
200 A		I			
Pole:					
1 pole			1		
2 poles			2		
Front plate colour:					
silver background and black knob		A			
yellow background and red knob		Y			
Acceptance tests:					
without additional quality requirements				0	
with an extra quality inspection certificate				1	

Ordering code PKT2- 60T_06WF _00
PKS2- 60T_06WF _00
PKH2- 60T_06WF _00

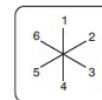

Multi-step PKT2- PKS2- PKH2-		60t	06WF	00	
Rated current:					
6 A		A			
10 A	PKT2	B			
16 A		C			
25 A		D			
32 A	PKS2	E			
40 A		F			
63 A		G			
100 A	PKH2	H			
200 A		I			
Pole:					
1 pole			1		
2 poles			2		
Front plate colour:					
silver background and black knob		A			
yellow background and red knob		Y			
Acceptance tests:					
without additional quality requirements				0	
with an extra quality inspection certificate				1	

Description	PKT2			PKS2				PKH2	
	6A	10A	16A	25A	32A	40A	63A	100A	200A
	Stage number								
1-polar 5-way without OFF	3	3	3	3	3	3	3	3	3
2-polar 5-way without OFF	5	5	5	5	5	5	5	5	5

Description	PKT2			PKS2				PKH2	
	6A	10A	16A	25A	32A	40A	63A	100A	200A
	Stage number								
1-polar 6-way without OFF	3	3	3	3	3	3	3	3	3
2-polar 6-way without OFF	6	6	6	6	6	6	6	6	6

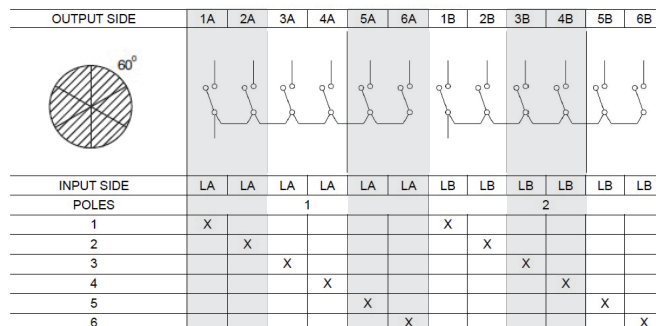
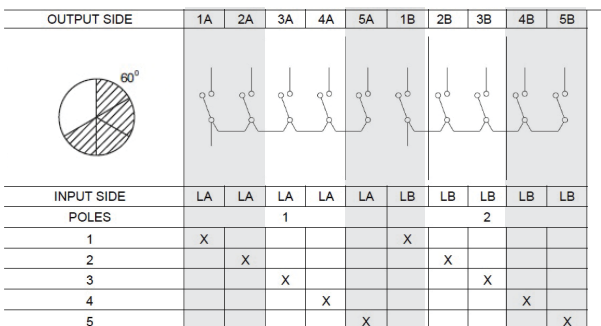

PKT2, PKS2, PKH2 SERIES

- MULTI-STEPS

WIRING DIAGRAMS AND CODING

MULTI-STEPS PKT2, PKS2, PKH2

Ordering code PKT2- 40L107WF__00
PKS2- 40L107WF__00

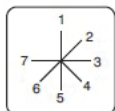

Multi-step PKT2- PKS2-		40L107WF	-	-	00
Rated current:					
6 A		A			
10 A	PKT2	B			
16 A		C			
25 A		D			
32 A		E			
40 A	PKS2	F			
63 A		G			
Front plate colour:					
silver background and black knob		A			
yellow background and red knob		Y			
Acceptance tests:					
without additional quality requirements				0	
with an extra quality inspection certificate				1	

Ordering code PKT2- 40T108WF__00
PKS2- 40T108WF__00

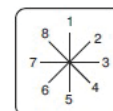

Multi-step PKT2- PKS2-		40T108WF	-	-	00
Rated current:					
6 A		A			
10 A	PKT2	B			
16 A		C			
25 A		D			
32 A		E			
40 A	PKS2	F			
63 A		G			
Front plate colour:					
silver background and black knob		A			
yellow background and red knob		Y			
Acceptance tests:					
without additional quality requirements				0	
with an extra quality inspection certificate				1	

Description	PKT2			PKS2			
	6A	10A	16A	25A	32A	40A	63A
	Stage number						
1-polar 7-way without OFF	4	4	4	4	4	4	4

Description	PKT2			PKS2			
	6A	10A	16A	25A	32A	40A	63A
	Stage number						
1-polar 8-way without OFF	4	4	4	4	4	4	4

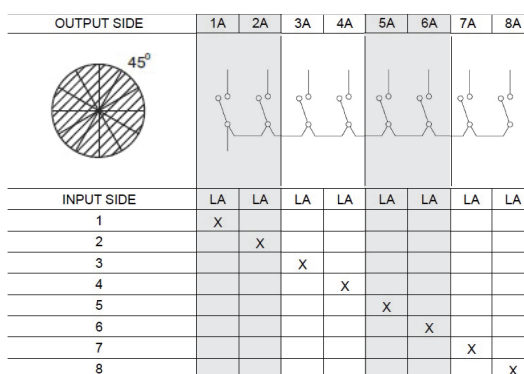
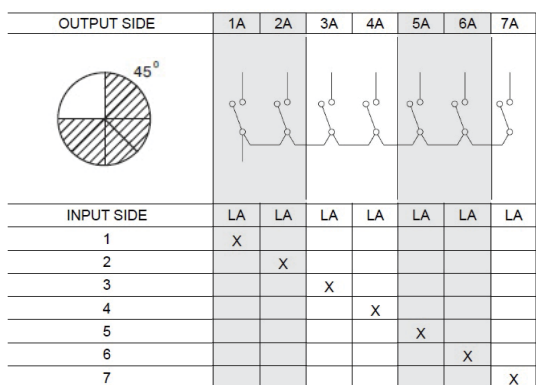

PKT2, PKS2, PKH2 SERIES

- MULTI-STEPS

WIRING DIAGRAMS AND CODING

MULTI-STEPS PKT2, PKS2, PKH2

Ordering code PKT2-30L109WF__00

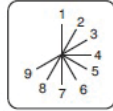

Multi-step PKT2-		30L109WF	-	-	00
Rated current:					
6 A		A			
10 A	PKT2	B			
16 A		C			
Front plate colour:					
silver background and black knob		A			
yellow background and red knob		Y			
Acceptance tests:					
without additional quality requirements				0	
with an extra quality inspection certificate				1	

Description	PKT2		
	6A	10A	16A
	Stage number		
1-polar 9-way without OFF	5	5	5

OUTPUT SIDE	1A	2A	3A	4A	5A	6A	7A	8A	9A
INPUT SIDE	LA	LA	LA	LA	LA	LA	LA	LA	LA
1	X								
2		X							
3			X						
4				X					
5					X				
6						X			
7							X		
8								X	
9									X

Ordering code PKT2-30L110WF__00

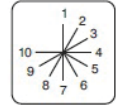

Multi-step PKT2-		30L110WF	-	-	00
Rated current:					
6 A		A			
10 A	PKT2	B			
16 A		C			
Front plate colour:					
silver background and black knob		A			
yellow background and red knob		Y			
Acceptance tests:					
without additional quality requirements				0	
with an extra quality inspection certificate				1	

Description	PKT2		
	6A	10A	16A
	Stage number		
1-polar 10-way without OFF	5	5	5

OUTPUT SIDE	1A	2A	3A	4A	5A	6A	7A	8A	9A	10A
INPUT SIDE	LA	LA	LA	LA	LA	LA	LA	LA	LA	LA
1	X									
2		X								
3			X							
4				X						
5					X					
6						X				
7							X			
8								X		
9									X	
10										X

Ordering code PKT2-30L111WF__00



Multi-step PKT2-		30L111WF	-	-	00
Rated current:					
6 A		A			
10 A		B			
16 A		C			
Front plate colour:					
silver background and black knob		A			
yellow background and red knob		Y			
Acceptance tests:					
without additional quality requirements				0	
with an extra quality inspection certificate				1	

Description	PKT2		
	6A	10A	16A
	Stage number		
1-polar 11-way without OFF	6	6	6

OUTPUT SIDE	1A	2A	3A	4A	5A	6A	7A	8A	9A	10A	11A
INPUT SIDE	LA	LA	LA	LA	LA	LA	LA	LA	LA	LA	LA
1	X										
2		X									
3			X								
4				X							
5					X						
6						X					
7							X				
8								X			
9									X		
10										X	
11											X

PKT2, PKS2, PKH2 SERIES

- MULTI-STEPS

WIRING DIAGRAMS AND CODING

MULTI-STEPS PKT2, PKS2, PKH2

Ordering code PKT2-30T112WF__00

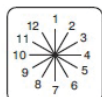

Multi-step PKT2-		30T112WF	-	-	00
Rated current:					
6 A	A				
10 A	PKT2	B			
16 A	C				
Front plate colour:					
silver background and black knob		A			
yellow background and red knob		Y			
Acceptance tests:					
without additional quality requirements				0	
with an extra quality inspection certificate				1	

Description	PKT2		
	6A	10A	16A
	Stage number		
1-polar 12-way without OFF	6	6	6

OUTPUT SIDE	1A	2A	3A	4A	5A	6A	7A	8A	9A	10A	11A	12A
INPUT SIDE	LA	LA	LA	LA	LA	LA	LA	LA	LA	LA	LA	LA
1	X											
2		X										
3			X									
4				X								
5					X							
6						X						
7							X					
8								X				
9									X			
10										X		
11											X	
12												X

CODING OF PKT2, PKS2, PKH2 SERIES

Multi-step PKT2- PKS2- PKH2-	-	-	0	-	-	-	-	F	-	-	00
Rated current:											
6 A	A										
10 A	PKT2	B									
16 A	C										
25 A	D										
32 A	PKS2	E									
40 A	F										
63 A	G										
100 A	H										
200 A	PKH2	I									
Angle:											
30°	3										
45°	4										
60°	6										
90°	9										
----- 0											
Rotation angle:											
360°								T			
less than 360°								L			
Pole:											
1 pole											1
2 poles											2
3 poles											3
4 poles											4
No. of ways:											
3 ways											03
4 ways											04
....											...
12 ways											12
OFF way:											
without OFF											W
with OFF											O
----- F											
Front plate colour:											
silver background and black knob		A									
yellow background and red knob		Y									
Acceptance tests:											
without additional quality requirements				0							
with an extra quality inspection certificate				1							
Version:											
standard											00
custom-made*											XX

* - only after agreeing with the manufacturer

PKT3, PKS3, PKH3 SERIES

- ISOLATORS

WIRING DIAGRAMS AND CODING

ISOLATORS PKT3, PKS3, PKH3

Ordering code PKT3- 60L XXOF 00
 PKS3- 60L XXOF 00
 PKH3- 60L XXOF 00

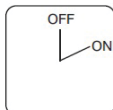

Isolator PKT3- PKS3- PKH3-		60L	XXOF			00
Rated current:						
6 A		A				
10 A	PKT3	B				
16 A		C				
25 A		D				
32 A		E				
40 A	PKS3	F				
63 A		G				
100 A		H				
200 A	PKH3	I				
Pole:						
1 pole			1			
2 poles			2			
....			...			
9 poles			9			
10 poles			A			
11 poles			B			
12 poles			C			
Front plate colour:						
silver background and black knob						A
yellow background and red knob						Y
Acceptance tests:						
without additional quality requirements						0
with an extra quality inspection certificate						1

Ordering code PKT3- 90L XXOF 00
 PKS3- 90L XXOF 00
 PKH3- 90L XXOF 00

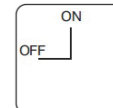

Isolator PKT3- PKS3- PKH3-		90L	XXOF			00
Rated current:						
6 A		A				
10 A	PKT3	B				
16 A		C				
25 A		D				
32 A		E				
40 A	PKS3	F				
63 A		G				
100 A		H				
200 A	PKH3	I				
Pole:						
1 pole			1			
2 poles			2			
....			...			
9 poles			9			
10 poles			A			
11 poles			B			
12 poles			C			
Front plate colour:						
silver background and black knob						A
yellow background and red knob						Y
Acceptance tests:						
without additional quality requirements						0
with an extra quality inspection certificate						1

ITEMS AVAILABLE FROM OUR STOCK:

PKT3-C60L3XXOFA000

- Isolator 16A, angle 60°, rotation angle <360°, 3 poles, with OFF, rectangular knob, silver background, black knob

PKT3-C60L3XXOFY000

- Isolator 16A, angle 60°, rotation angle <360°, 3 poles, with OFF, rectangular knob, yellow background, red knob

Description	PKT3			PKS3				PKH3	
	6A	10A	16A	25A	32A	40A	63A	100A	200A
	Stage number								
1-polar ON-OFF	1	1	1	1	1	1	1	1	1
2-polar ON-OFF	1	1	1	1	1	1	1	1	1
3-polar ON-OFF	2	2	2	2	2	2	2	2	2
4-polar ON-OFF	2	2	2	2	2	2	2	2	2
5-polar ON-OFF	3	3	3	3	3	3	3	3	3
6-polar ON-OFF	3	3	3	3	3	3	3	3	3

Description	PKT3			PKS3				PKH3	
	6A	10A	16A	25A	32A	40A	63A	100A	200A
	Stage number								
1-polar ON-OFF	1	1	1	1	1	1	1	1	1
2-polar ON-OFF	1	1	1	1	1	1	1	1	1
3-polar ON-OFF	2	2	2	2	2	2	2	2	2
4-polar ON-OFF	2	2	2	2	2	2	2	2	2
5-polar ON-OFF	3	3	3	3	3	3	3	3	3
6-polar ON-OFF	3	3	3	3	3	3	3	3	3

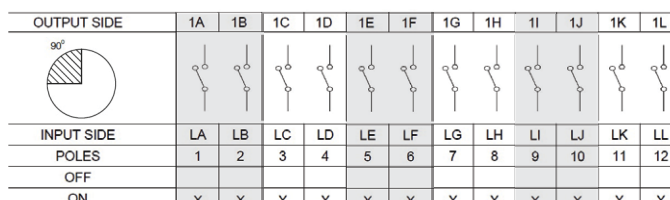
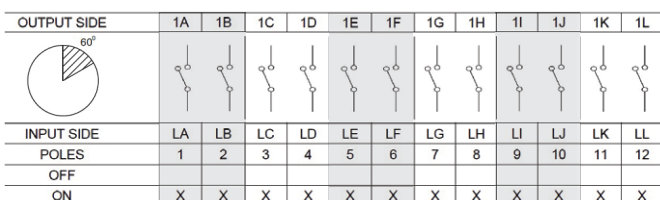

PKT3, PKS3, PKH3 SERIES

- ISOLATORS

WIRING DIAGRAMS AND CODING

ISOLATORS PKT3, PKS3, PKH3

Ordering code PKT3- 90T XXOF _ 00
 PKS3- 90T XXOF _ 00
 PKH3- 90T XXOF _ 00

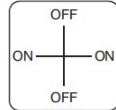

Isolator PKT3- PKS3- PKH3-		90T	XXOF			00
Rated current:						
6 A		A				
10 A	PKT3	B				
16 A		C				
25 A		D				
32 A		E				
40 A	PKS3	F				
63 A		G				
100 A		H				
200 A	PKH3	I				
Pole:						
1 pole			1			
2 poles			2			
....			...			
9 poles			9			
10 poles			A			
11 poles			B			
12 poles			C			
Front plate colour:						
silver background and black knob						A
yellow background and red knob						Y
Acceptance tests:						
without additional quality requirements						0
with an extra quality inspection certificate						1

Ordering code PKT3- 40L XXOF _ 00
 PKS3- 40L XXOF _ 00

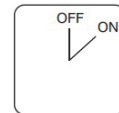

Isolator PKT3- PKS3-		40L	XXOF			00
Rated current:						
6 A		A				
10 A	PKT3	B				
16 A		C				
25 A		D				
32 A		E				
40 A	PKS3	F				
63 A		G				
Pole:						
1 pole			1			
2 poles			2			
....			...			
9 poles			9			
10 poles			A			
11 poles			B			
12 poles			C			
Front plate colour:						
silver background and black knob						A
yellow background and red knob						Y
Acceptance tests:						
without additional quality requirements						0
with an extra quality inspection certificate						1

Description	PKT3			PKS3				PKH3	
	6A	10A	16A	25A	32A	40A	63A	100A	200A
	Stage number								
1-polar ON-OFF	1	1	1	1	1	1	1	1	1
2-polar ON-OFF	1	1	1	1	1	1	1	1	1
3-polar ON-OFF	2	2	2	2	2	2	2	2	2
4-polar ON-OFF	2	2	2	2	2	2	2	2	2
5-polar ON-OFF	3	3	3	3	3	3	3	3	3
6-polar ON-OFF	3	3	3	3	3	3	3	3	3

Description	PKT3			PKS3			
	6A	10A	16A	25A	32A	40A	63A
	Stage number						
1-polar ON-OFF	1	1	1	1	1	1	1
2-polar ON-OFF	1	1	1	1	1	1	1
3-polar ON-OFF	2	2	2	2	2	2	2
4-polar ON-OFF	2	2	2	2	2	2	2
5-polar ON-OFF	3	3	3	3	3	3	3
6-polar ON-OFF	3	3	3	3	3	3	3

OUTPUT SIDE	1A	1B	1C	1D	1E	1F	1G	1H	1I	1J	1K	1L
INPUT SIDE	LA	LB	LC	LD	LE	LF	LG	LH	LI	LJ	LK	LL
POLES	1	2	3	4	5	6	7	8	9	10	11	12
OFF												
ON	X	X	X	X	X	X	X	X	X	X	X	X

OUTPUT SIDE	1A	1B	1C	1D	1E	1F	1G	1H	1I	1J	1K	1L
INPUT SIDE	LA	LB	LC	LD	LE	LF	LG	LH	LI	LJ	LK	LL
POLES	1	2	3	4	5	6	7	8	9	10	11	12
OFF												
ON	X	X	X	X	X	X	X	X	X	X	X	X

PKT3, PKS3, PKH3 SERIES

- ISOLATORS

WIRING DIAGRAMS AND CODING

ISOLATORS PKT3, PKS3, PKH3

CODING OF PKT3, PKS3, PKH3 SERIES

Isolator PKT3- PKS3- PKH3-		-	-	0	-	-	XX	O	F	-	-	00
Rated current:												
6 A		A										
10 A	PKT3	B										
16 A		C										
25 A		D										
32 A	PKS3	E										
40 A		F										
63 A		G										
100 A	PKH3	H										
200 A		I										
Angle:												
45°			4									
60°			6									
90°			9									
----- 0												
Rotation angle:												
360° *						T						
less than 360°						L						
Pole:												
1 pole						1						
2 poles						2						
....						...						
9 poles						9						
10 poles						A						
11 poles						B						
12 poles						C						
----- XX												
----- O												
----- F												
Front plate colour:												
silver background and black knob									A			
yellow background and red knob									Y			
Acceptance tests:												
without additional quality requirements											0	
with an extra quality inspection certificate											1	
Version:												
standard												00
custom-made**												XX

* - only for rotation angle 90°

** - only after agreeing with the manufacturer

WIRING DIAGRAMS AND CODING

SELECTOR SWITCHES PKT4

Ordering code PKT4- **69L**XXXOF _ _ 00

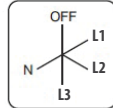

Selector switch PKT4-	69LXXXOF			00
Rated current:				
6 A	A			
10 A	B			
16 A	C			
20 A	D			
Front plate colour:				
silver background and black knob	A			
yellow background and red knob	Y			
Acceptance tests:				
without additional quality requirements			0	
with an extra quality inspection			1	

ITEMS AVAILABLE FROM OUR STOCK:

PKT4-C69LXXXOFA000

- Selector switch 16A, do amperomierza, 5-way L123/N/OFF, rotation angle <360°, with OFF, rectangular knob, silver background, black knob

PKT4-C69LXXXOFY000

- Selector switch 16A, do amperomierza, 5-way L123/N/OFF, rotation angle <360°, with OFF, rectangular knob, yellow background, red knob

Description	PKT4		
	6A	10A	16A
	Stage number		
5-way for the ammeter	4	4	4

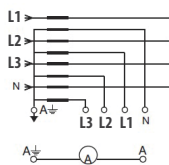
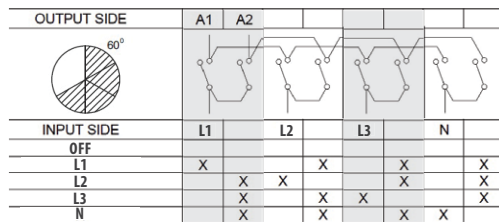

Ordering code PKT4- **97T**XXXOF _ _ 00

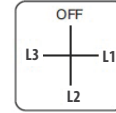

Selector switch PKT4-	97TXXXOF			00
Rated current:				
6 A	A			
10 A	B			
16 A	C			
20 A	D			
Front plate colour:				
silver background and black knob	A			
yellow background and red knob	Y			
Acceptance tests:				
without additional quality requirements			0	
with an extra quality inspection			1	

ITEMS AVAILABLE FROM OUR STOCK:

PKT4-C97TXXXOFA000

- Selector switch 16A, do amperomierza, 4-way L123/OFF, rotation angle 360°, with OFF, rectangular knob, silver background, black knob

PKT4-C97TXXXOFY000

- Selector switch 16A, do amperomierza, 4-way L123/OFF, rotation angle 360°, with OFF, rectangular knob, yellow background, red knob

Description	PKT4		
	6A	10A	16A
	Stage number		
4-way for the ammeter	3	3	3

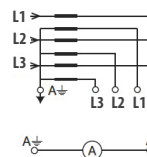
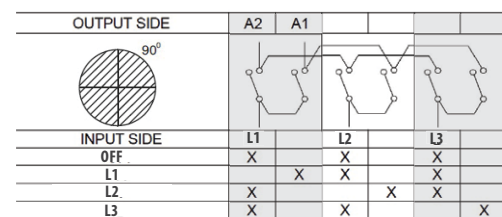

PKT4 SERIES

- SELECTOR SWITCHES

WIRING DIAGRAMS AND CODING

SELECTOR SWITCHES PKT4

Ordering code PKT4- **4HL**XXXOF__00

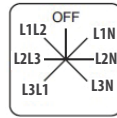

Selector switch PKT4-	4HLXXXOF			00
Rated current:				
6 A	A			
10 A	B			
16 A	C			
20 A	D			
Front plate colour:				
silver background and black knob	A			
yellow background and red knob	Y			
Acceptance tests:				
without additional quality requirements			0	
with an extra quality inspection			1	

ITEMS AVAILABLE FROM OUR STOCK:

PKT4-C4HLXXXOFA000

- Selector switch 16A, do woltomierza, 7-way L-L/L-N/OFF, rotation angle <math><360^\circ</math>, with OFF, rectangular knob, silver background, black knob

PKT4-C4HLXXXOFY000

- Selector switch 16A, do woltomierza, 7-way L-L/L-N/OFF, rotation angle <math><360^\circ</math>, with OFF, rectangular knob, yellow background, red knob

Description	PKT4		
	6A	10A	16A
	Stage number		
Phase and phase-to-phase voltages	3	3	3

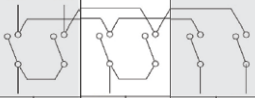
OUTPUT SIDE	V2	V1			
					
INPUT SIDE	L3	L2	L1	N	
L3L1	X		X		
L2L2	X	X			
L1L2			X	X	
OFF					
L1N			X	X	
L2N		X		X	
L3N	X			X	

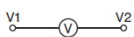
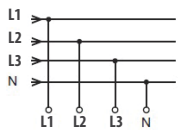

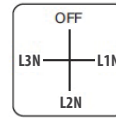

Ordering code PKT4- **9BT**XXXOF__00



Selector switch PKT4-	9BTXXXOF			00
Rated current:				
6 A	A			
10 A	B			
16 A	C			
20 A	D			
Front plate colour:				
silver background and black knob	A			
yellow background and red knob	Y			
Acceptance tests:				
without additional quality requirements			0	
with an extra quality inspection			1	

Description	PKT4		
	6A	10A	16A
	Stage number		
Phase voltages	3	3	3

OUTPUT SIDE	V1	V2			
					
INPUT SIDE	N	L1	N	L2	L3
OFF					
L1L2	X	X			
L2L3			X	X	
L3L1					X

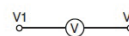
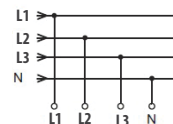

PKT4 SERIES

- SELECTOR SWITCHES

WIRING DIAGRAMS AND CODING

SELECTOR SWITCHES PKT4

Ordering code PKT4- 98TXXXOF _ _ 00

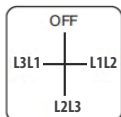

Selector switch PKT4-		98TXXXOF			00
Rated current:					
6 A	A				
10 A	B				
16 A	C				
20 A	D				
Front plate colour:					
silver background and black knob		A			
yellow background and red knob		Y			
Acceptance tests:					
without additional quality requirements		0			
with an extra quality inspection		1			

Description	PKT4		
	6A	10A	16A
	Stage number		
Phase-to-phase voltages	3	3	3

STRONA WYJŚCIOWA	V2	V1			
STRONA WEJŚCIOWA	L1	L2	L3		
OFF					
L1L2	X		X		
L2L3		X			X
L3L1		X		X	

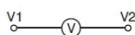
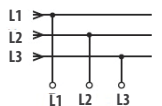

CODING OF PKT4

Selector switch PKT4-				X	XX	O	F			00
Rated current:										
6 A	A									
10 A	B									
16 A	C									
20 A	D									
Meter type:										
ammeter L123/OFF/90°	97									
ammeter L123/N/OFF/60°	69									
voltmeter L-L/L-N/OFF/45°	4H									
voltmeter L-L/OFF/90°	98									
voltmeter L-N/OFF/90°	9B									
Rotation angle:										
360° *	T									
less than 360° **	L									
				X						
					XX					
						O				
							F			
Front plate colour:										
silver background and black knob		A								
yellow background and red knob		Y								
Acceptance tests:										
without additional quality requirements		0								
with an extra quality inspection certificate		1								
Version:										
standard		00								
custom-made***		XX								

* - only for rotation angle 90°









** - only for rotation angle 45° i 60°

*** - only after agreeing with the manufacturer

PKT/ PKS/ PKH SERIES

- CAM SWITCHES

ACCESSORIES - ORDERING

Ordering code	Description	View	Cam switch type
20-042-06-00007	CAM SWITCH KNOB (Black)		PKT1, PKT2, PKT3, PKT4, PKS1, PKS2, PKS3, PKH1, PKH2, PKH3
20-042-06-00008	CAM SWITCH KNOB (Red)		PKT1, PKT2, PKT3, PKT4, PKS1, PKS2, PKS3, PKH1, PKH2, PKH3
20-042-06-00009	FRONT PLATE CAM SWITCH (Yellow)		PKT1, PKT2, PKT3, PKT4
20-042-06-00010	Yellow BLANK PAPER FOR MARKING PLATE		PKT1, PKT2, PKT3, PKT4
20-042-06-00011	Yellow BLANK PAPER FOR NAME PLATE		PKT1, PKT2, PKT3, PKT4
20-042-06-00012	BLANK NAME PLATE		PKT1, PKT2, PKT3, PKT4
20-042-06-00013	BLANK MARKING PLATE		PKT1, PKT2, PKT3, PKT4
20-042-06-00016	SCREWS AND NUTS		PKT1, PKT2, PKT3, PKT4

PKT-19_en

