

Contents

1. SPECIFICATIONS

- 1.1 Features
- 1.2 Mechanical Specifications
- 1.3 Absolute Maximum Ratings
- 1.4 DC Electrical Characteristics
- 1.5 Optical Characteristics
- 1.6 Backlight Characteristics

2. MODULE STRUCTURE

- 2.1 Counter Drawing
- 2.2 Interface Pin Description
- 2.3 Timing Characteristics

3. QUALITY ASSURANCE SYSTEM

- 3.1 Quality Assurance Flow Chart
- 3.2 Inspection Specification

4. RELIABILITY TEST

- 4.1 Reliability Test Condition

5. PRECAUTION RELATING PRODUCT HANDLING

- 5.1 Safety
- 5.2 Handling
- 5.3 Storage
- 5.4 Terms of Warranty

Appendix : 1.LCM Drawing

2. Packing Specification

Note : For detailed information please refer to IC data sheet :

Primacy(TFT LCD): ILITEK-- ILI6122M-9G / ILI5960-9G

(Or compatible IC)

1. SPECIFICATIONS

1.1 Features

Item	Standard Value
Display Type	800 * 3 (RGB) * 480 Dots
LCD Type	a-Si TFT , Normally white, Transmissive type
Screen size(inch)	5.0 inch
Viewing Direction	6 O'clock
Color configuration	RGB-Strip
Backlight Type	LED B/L
Interface	Digital 24-bits RGB
Other(controller/driver IC)	Soruce IC : ILI6122M-9G / Gate IC: ILI5960-9G (Or Compatible IC)
ROHS	THIS PRODUCT CONFORMS THE ROHS OF PTC Detail information please refer website : http://www.powertip.com.tw/news.php?area_id_view=1085560481/

1.2 Mechanical Specifications

Item	Standard Value	Unit
Outline Dimension	121.0(W) x 75.9 (L) x 3.1(H)	mm

LCD panel

Item	Standard Value	Unit
Viewing Area	109.0 (W) * 65.8 (L)	mm
Active Area	108.0 (W) x 64.8 (L)	mm
Pixel Size	0.135 (W) * 0.135 (H)	mm

Note : For detailed information please refer to LCM drawing

1.3 Absolute Maximum Ratings

Module

Item	Symbol	Condition	Min.	Max.	Unit
System Power Supply Voltage	VDD	GND=0	-0.3	4.5	V
Operating Temperature	T _{OP}	-	-20	70	°C
Storage Temperature	T _{ST}	-	-30	80	°C
Storage Humidity	H _D	T _a ≦ 60 °C	10	90	%RH

1.4 DC Electrical Characteristics

Module

GND = 0V, T_a = 25 °C

Item	Symbol	Condition	Min.	Typ.	Max.	Unit
Power Supply Voltage	VDD	-	3.0	3.3	3.6	V
Input H/L Level Voltage	V _{IH}	-	0.7VDD	-	VDD	V
	V _{IL}	-	GND	-	0.3VDD	V
Output H/L Level Voltage	V _{OH}	-	VDD-0.4	-	VDD	V
	V _{OL}	-	GND	-	GND+0.4	V
Supply Current	I _{DD}	VDD= 3.3 V Pattern=Photo	-	100	-	mA
		VDD= 3.3 V Pattern=R *1	-	120	180	mA

Note1:Maximum current display

1.5 Optical Characteristics

TFT LCD Module

VDD= 3.3 V, Ta=25°C

Item		Symbol	Condition	Min.	Typ.	Max.	unit	-
Response time	Tr+Tf	25°C	-	-	35	55	ms	-
Viewing angle	Top	$\theta Y+$	CR \geq 10		60	-	Deg.	Note 4
	Bottom	$\theta Y-$			60	-		
	Left	$\theta X-$			60	-		
	Right	$\theta X+$			60	-		
Contrast ratio		CR		500	600	-	-	Note 3
Color of CIE Coordinate (With B/L & LCD)	White	X	Ta = 25°C $\theta X, \theta Y = 0^\circ$	0.25	0.30	0.35	-	Note1
		Y		0.28	0.33	0.38		
	Red	X		0.49	0.54	0.9		
		Y		0.27	0.32	0.37		
	Green	X		0.29	0.34	0.39		
		Y		0.54	0.59	0.64		
	Blue	X		0.09	0.14	0.19		
		Y		0.03	0.08	0.13		
Average Brightness Pattern=white display (With LCD)*1		IV	IF= 120 mA	800	900	-	cd/m2	Note1
Uniformity (With LCD)*2		ΔB	IF= 120 mA	70	-	-	%	Note1

Note 1:

*1 : $\Delta B = B(\text{min}) / B(\text{max}) * 100\%$

*2 : Measurement Condition for Optical Characteristics:

- a : Environment: $25^{\circ}\text{C} \pm 5^{\circ}\text{C}$ / $60 \pm 20\% \text{R.H}$, no wind , dark room below 10 Lux at typical lamp current and typical operating frequency.
- b : Measurement Distance: 500 ± 50 mm , ($\theta = 0^{\circ}$)
- c : Equipment: TOPCON BM-7 fast , (field 1°) , after 10 minutes operation.
- d : The uncertainty of the C.I.E coordinate measurement ± 0.01 , Average Brightness $\pm 4\%$

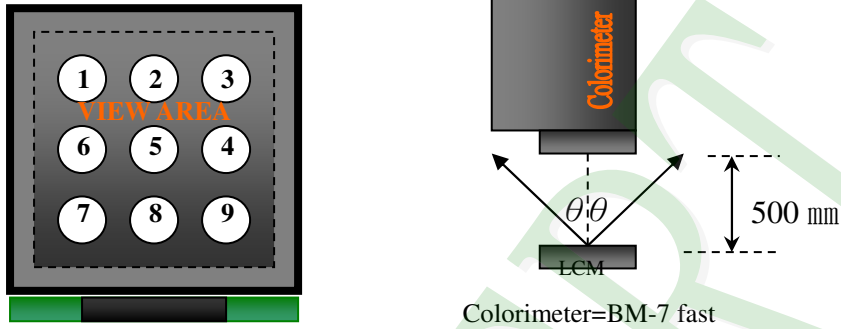

To be measured at the center area of panel with a viewing cone of 1° by Topcon luminance meter BM-7, after 10 minutes operation (module)

Note2: Definition of response time:

The output signals of photo detector are measured when the input signals are changed from "black" to "white"(falling time) and from "white" to "black"(rising time), respectively. The response time is defined as the time interval between the 10% and 90% of Amplitudes.

Refer to figure as below:

Normally White



Normally Black

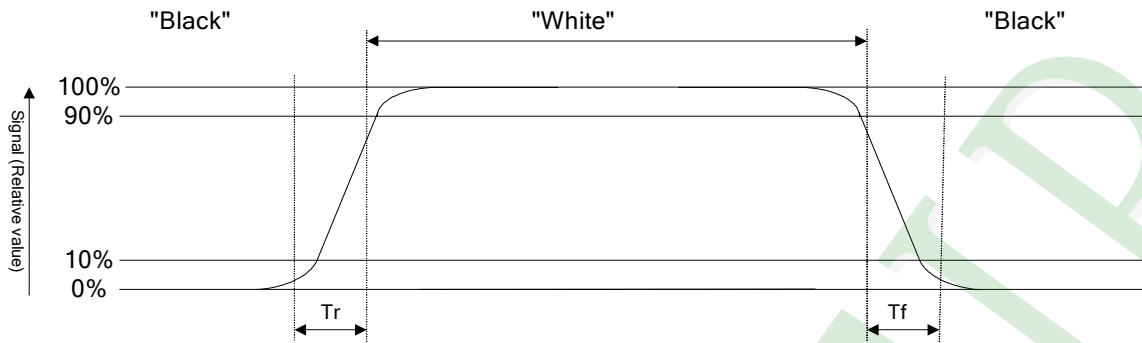

Note3: Definition of contrast ratio:

Contrast ratio is calculated with the following formula

$$\text{Contrast ratio (CR)} = \frac{\text{Photo detector output when LCD is at "White" state}}{\text{Photo detector output when LCD is at "Black" state}}$$

Note4: Definition of viewing angle:

Refer to figure as below:

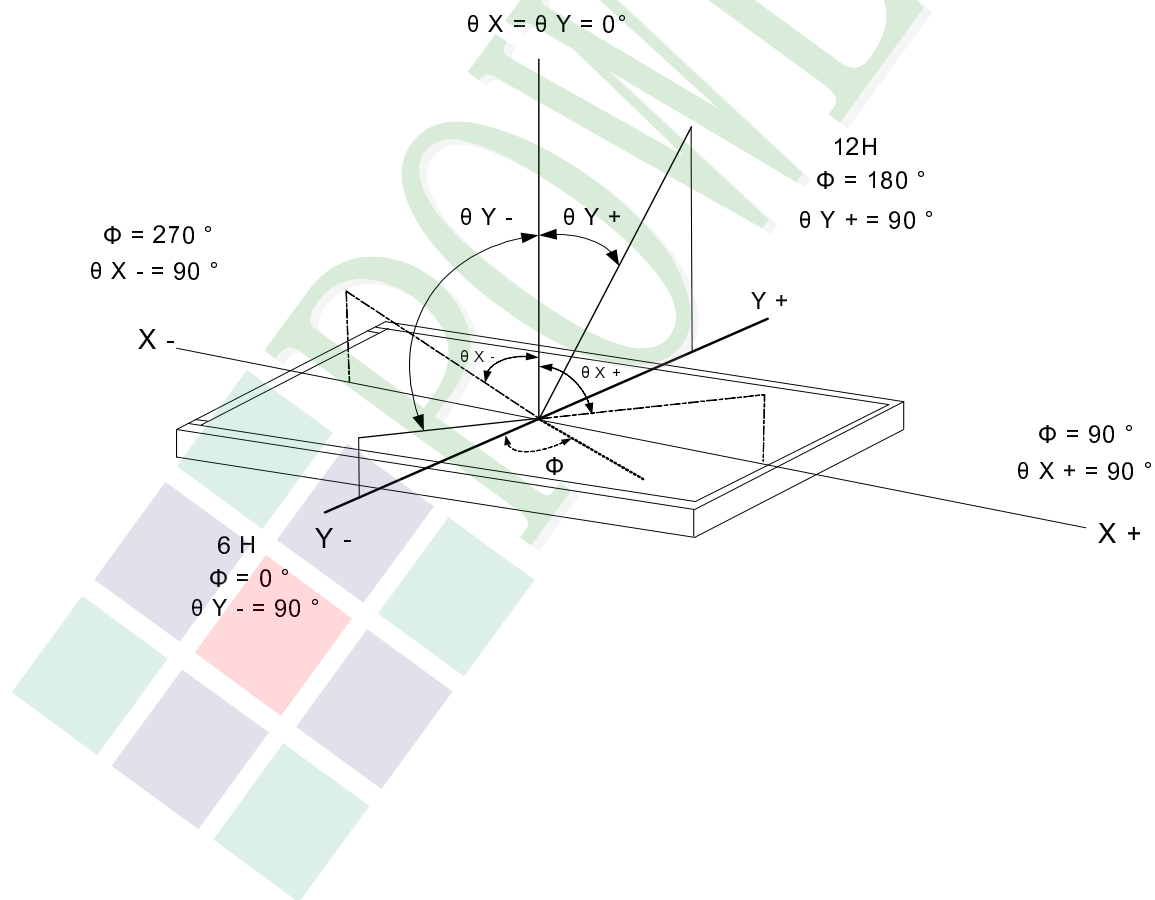

1.6 Backlight Characteristics

Maximum Ratings

Item	Symbol	Conditions	Min.	Max.	Unit
LED Forward Current	IF	Ta =25°C	-	210	mA
LED Reverse Voltage	IR	Ta =25°C	-	10	V
Power Dissipation	PD	Ta =25°C	-	4284	mW

Electrical / Optical Characteristics

Item	Symbol	Conditions	Min.	Typ.	Max.	Unit
Forward Voltage	VF	IF=120mA	16.8	18.6	-	V
Average Brightness (Without LCD)	IV		20500	23500	-	cd/m ²
CIE Color Coordinate (Without LCD)	X		0.25	0.28	0.31	-
	Y		0.25	0.28	0.31	
Color	White					

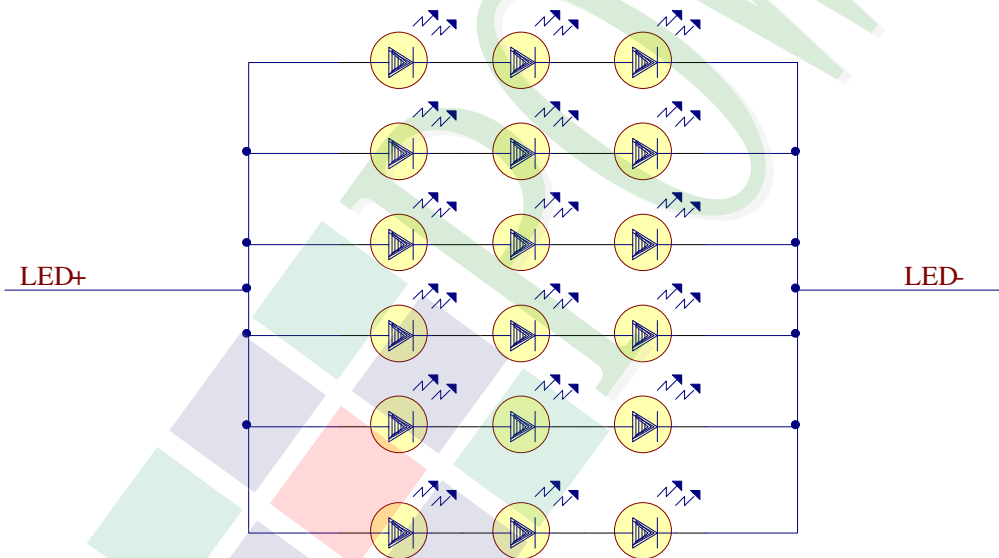

Other Description

Item	Conditions	Description
Life Time	Ta =25°C IF= 120mA	30,000 hrs

2. MODULE STRUCTURE

2.1 Counter Drawing

2.1.1 LCM Mechanical Diagram

* See Appendix

2.1.2 Block Diagram

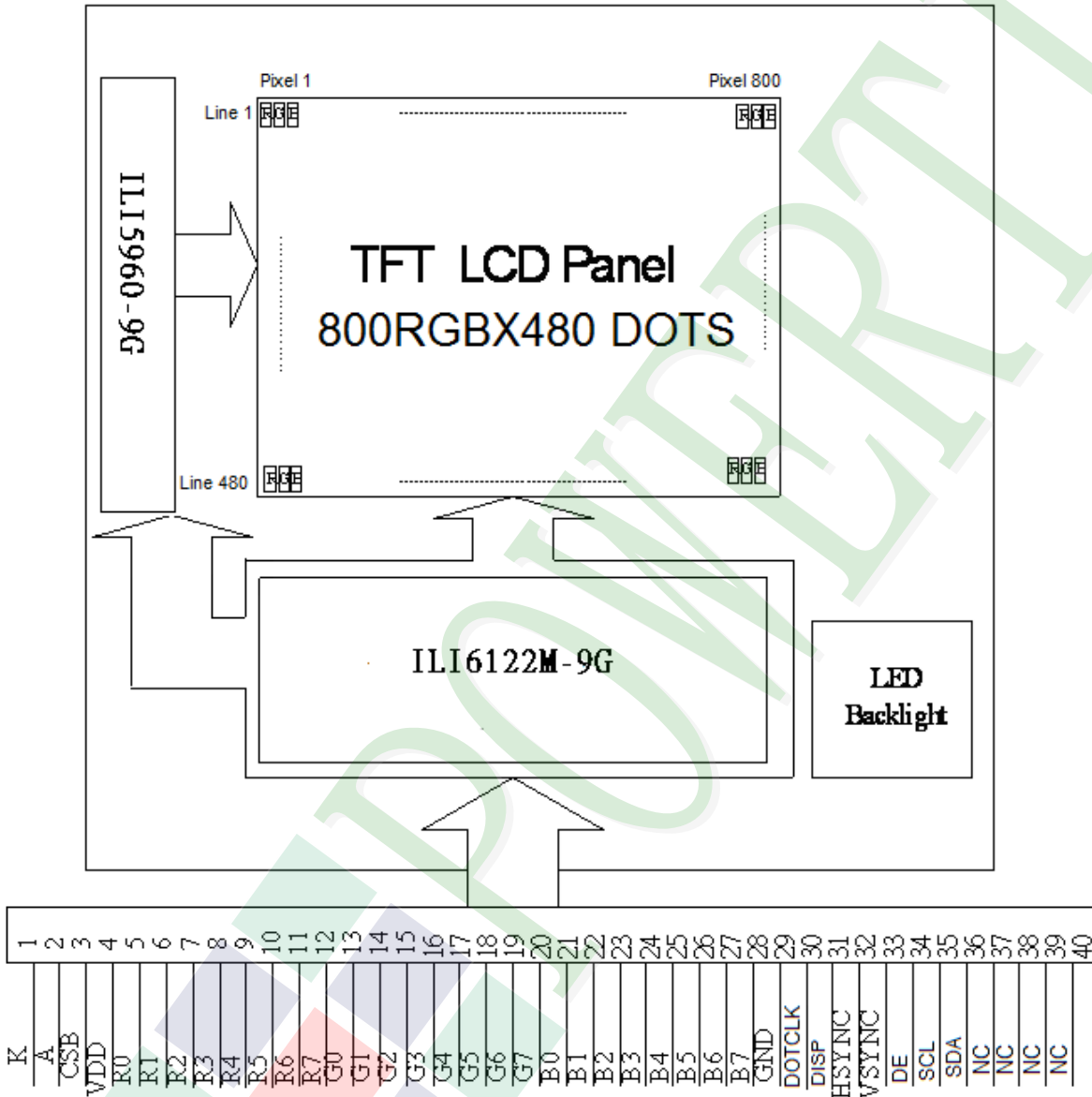

2.2 Interface Pin Description

Pin No.	Symbol	Function
1	LED-	Power supply for LED Backlight cathode input
2	LED+	Power supply for LED Backlight anode input
3	CS(NC)	Chip select pin of serial interface.
4	VDD	Digital power
5	R0	Red data bit 0
6	R1	Red data bit 1
7	R2	Red data bit 2
8	R3	Red data bit 3
9	R4	Red data bit 4
10	R5	Red data bit 5
11	R6	Red data bit 6
12	R7	Red data bit 7
13	G0	Green data bit 0
14	G1	Green data bit 1
15	G2	Green data bit 2
16	G3	Green data bit 3
17	G4	Green data bit 4
18	G5	Green data bit 5
19	G6	Green data bit 6
20	G7	Green data bit 7

Pin No.	Symbol	Function
21	B0	Blue data bit 0
22	B1	Blue data bit 1
23	B2	Blue data bit 2
24	B3	Blue data bit 3
25	B4	Blue data bit 4
26	B5	Blue data bit 5
27	B6	Blue data bit 6
28	B7	Blue data bit 7
29	GND	Ground
30	DOTCLK	Dot data clock, latching data at the rising edge
31	DISP	Display on/ off
32	HSYNC	Horizontal sync input
33	VSYNC	Vertical sync input
34	DE	Data enable
35	SCL(NC)	Data input and output in Serial communication/No connection when no using serial communication
36	SDA(NC)	Clock input in Serial communication / No connection when no using serial communication
37	NC	Not Connect
38	NC	Not Connect
39	NC	Not Connect
40	NC	Not Connect

2.3 Timing Characteristics

2.3.1 Vertical input timing

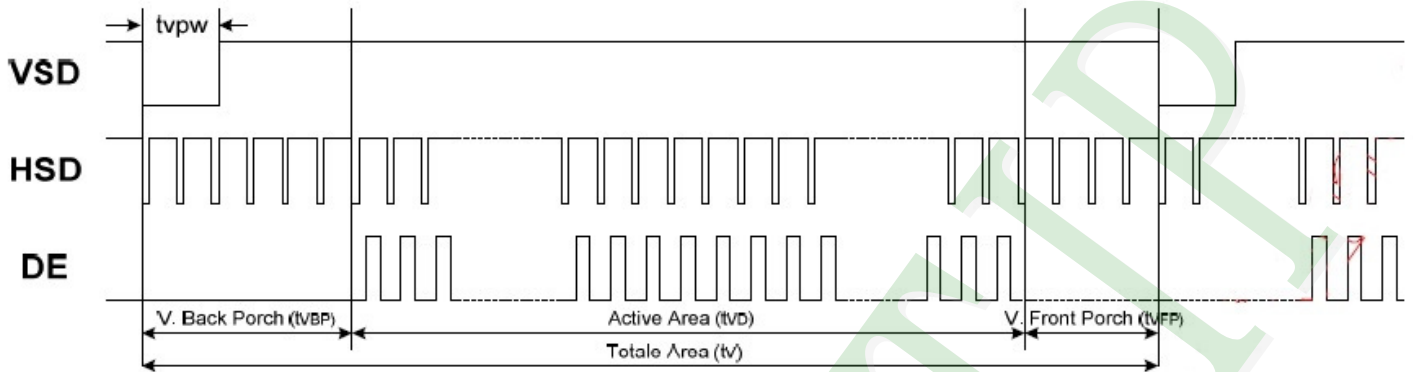

Parameter	Symbol	Value			Unit
		Min	Typ	Max	
Vertical display area	tvd		480		H
VSD period time	tv	510	525	650	H
VSD pulse width	tvpw	1	-	20	H
VSD Back Porch(Blanking)	tvb	23	23	23	H
VSD Front Proch	tvfb	7	22	147	H

2.3.2 Horizontal input timing

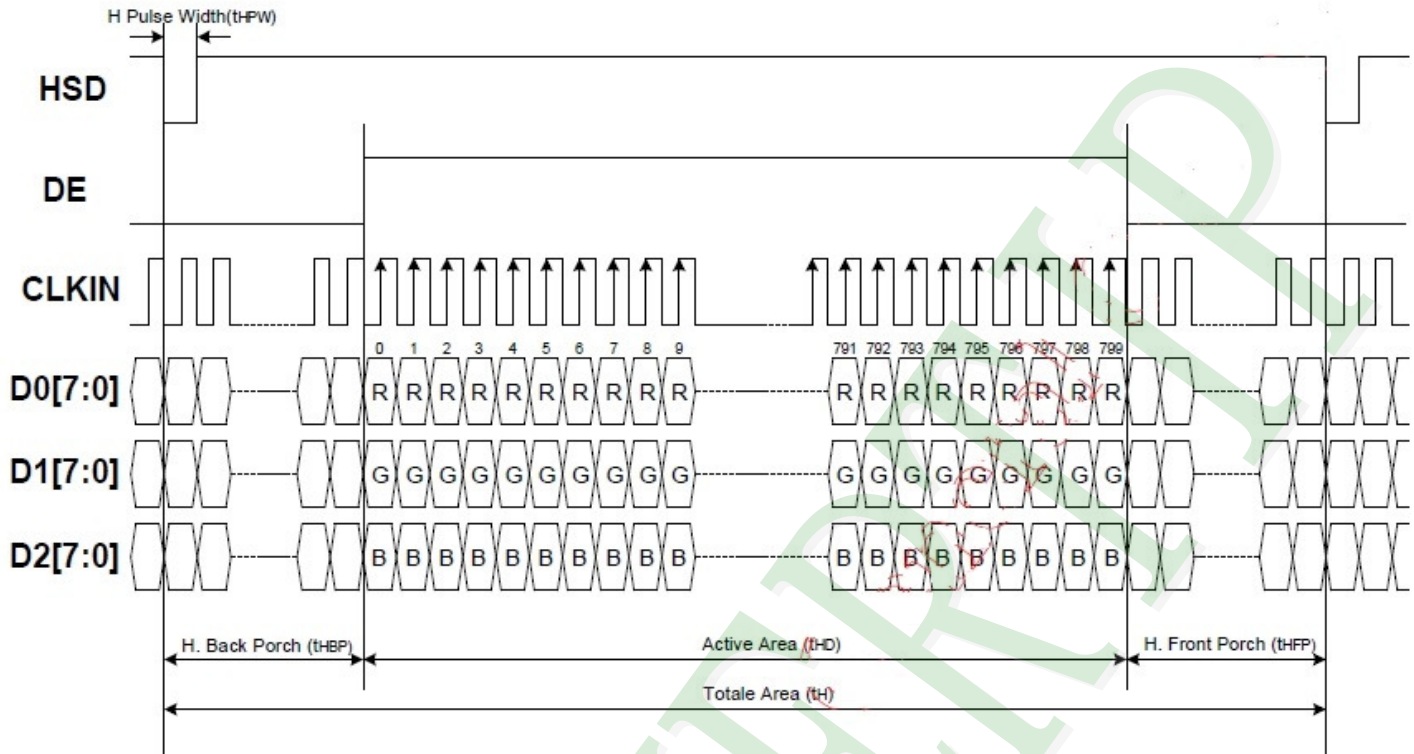

Parameter	Symbol	Value			Unit
		Min	Typ	Max	
Horizontal display area	thd		800		DCLK
DCLK frequency	fclk	-	33.3	50	MHz
1 Horizontal Line	th	862	1056	1200	DCLK
HSD pulse width	Min	-	1		
	Typ	-	-		
	Max	-	40		
HSD Back Porch (Blacking)	thp	46	46	46	
HSD Front Proch	thfb	16	210	354	

2.3.2 Input Clock and Data Timing

DE Mode

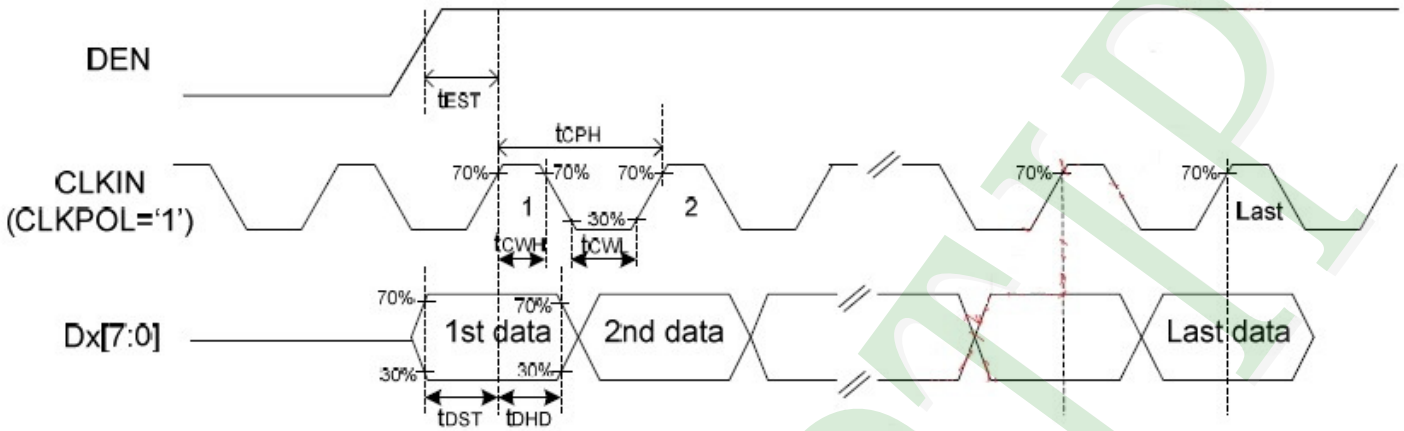

SYNC Mode

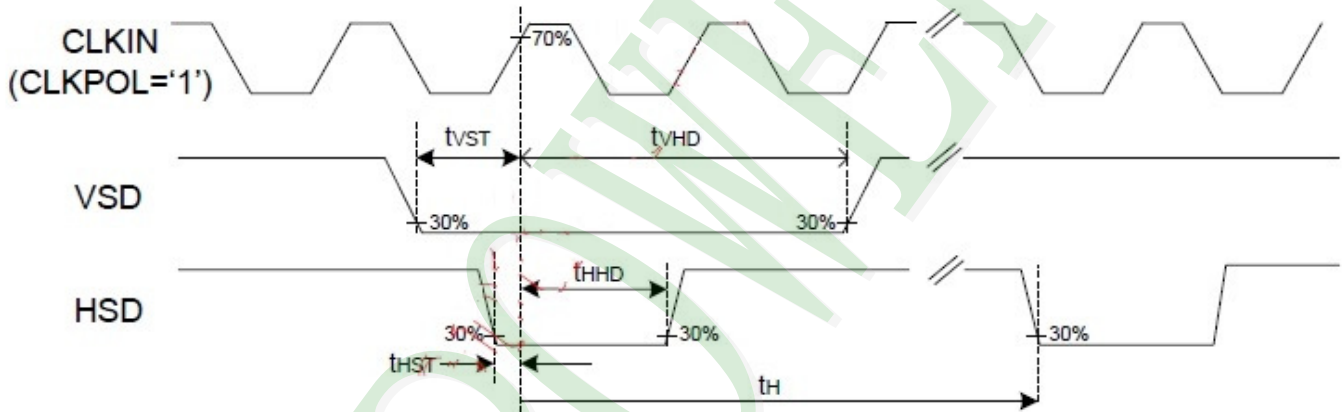

3. QUALITY ASSURANCE SYSTEM

3.1 Quality Assurance Flow Chart

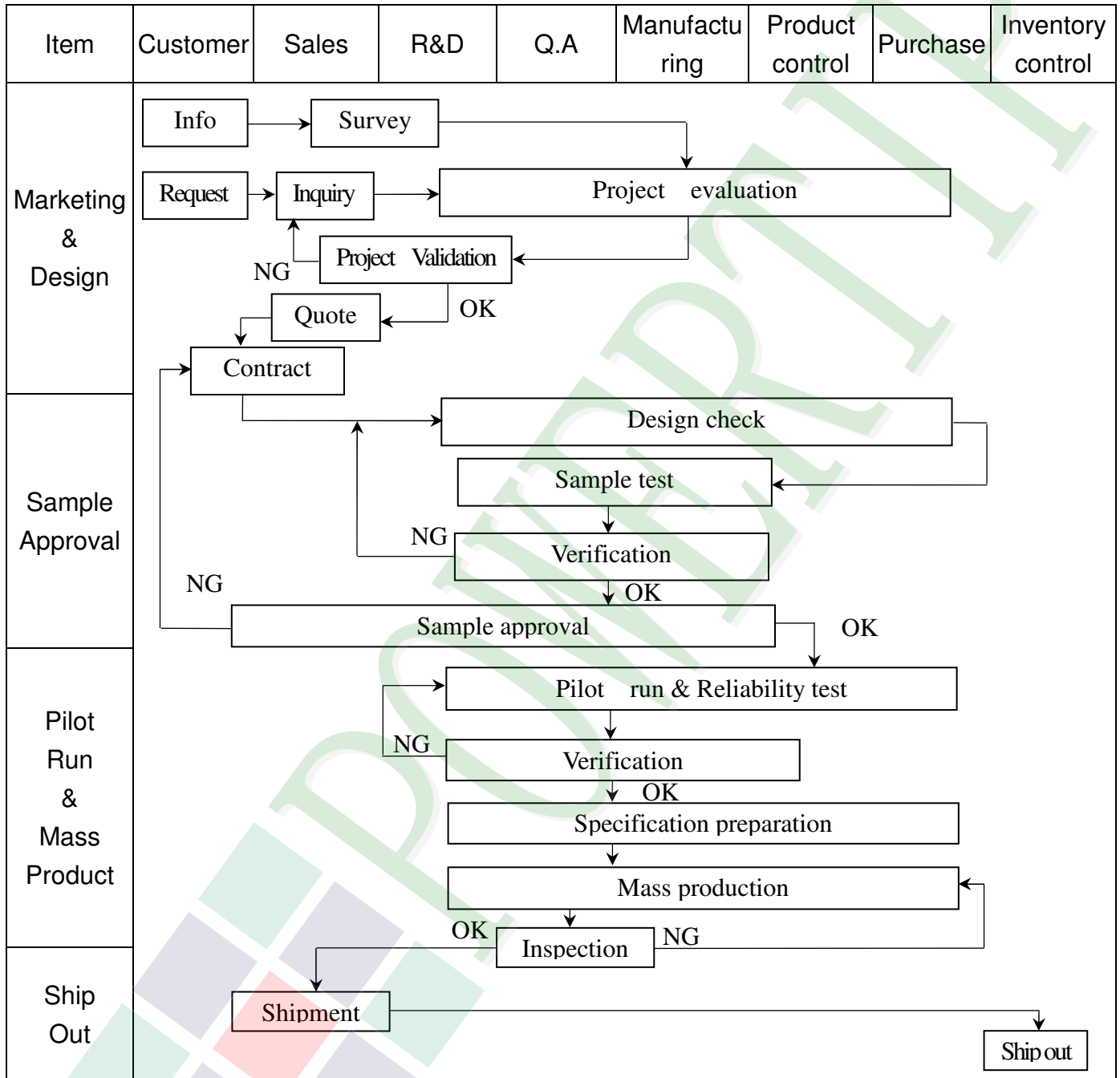

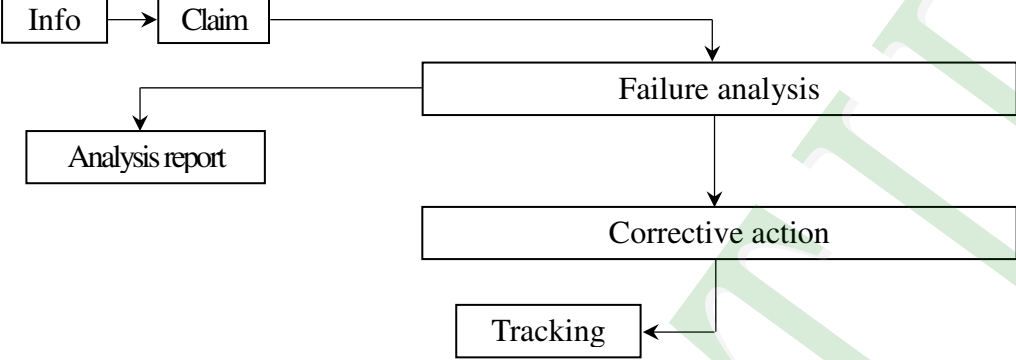
Item	Customer	Sales	R&D	Q.A	Manufacturing	Product control	Purchase	Inventory control
Sales Service	 <pre> graph TD Info[Info] --> Claim[Claim] Claim --> Failure[Failure analysis] Claim --> Report[Analysis report] Failure --> Action[Corrective action] Action --> Tracking[Tracking] </pre>							
Q.A Activity	1. ISO 9001 Maintenance Activities 3. Equipment calibration 5. Standardization Management				2. Process improvement proposal 4. Education And Training Activities			

3.2 Inspection Specification

- ◆Scope : The document shall be applied to TFT-LCD Module for 3.5" ~10" (Ver.B01).
- ◆Inspection Standard : MIL-STD-105E Table Normal Inspection Single Sampling Level II.
- ◆Equipment : Gauge 、 MIL-STD 、 Powertip Tester 、 Sample
- ◆Defect Level : Major Defect AQL : 0.4 ; Minor Defect AQL : 1.5
- ◆OUT Going Defect Level : Sampling.
- ◆Standard of the product appearance test :

a. Manner of appearance test :

- (1). The test best be under 20W×2 fluorescent light , and distance of view must be at 30 cm.
- (2). The test direction is base on about around 45° of vertical line.

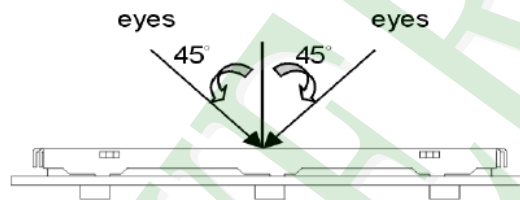

(3). Definition of area.

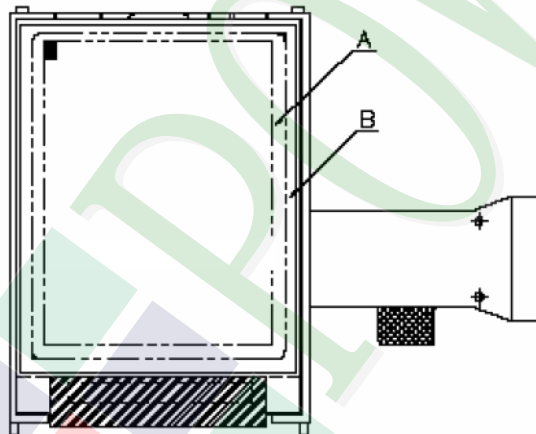

A area : viewing area

B area : Outside of viewing area

(4). Standard of inspection : (Unit : mm)

◆ Specification For TFT-LCD Module 3.5" ~10" :

(Ver.B01)

NO	Item	Criterion	Level										
01	Product condition	1. 1 The part number is inconsistent with work order of production.	Major										
		1. 2 Mixed product types.	Major										
		1. 3 Assembled in inverse direction.	Major										
02	Quantity	2. 1 The quantity is inconsistent with work order of production.	Major										
03	Outline dimension	3. 1 Product dimension and structure must conform to structure diagram.	Major										
04	Electrical Testing	4. 1 Missing line character and icon.	Major										
		4. 2 No function or no display.	Major										
		4. 3 Display malfunction.	Major										
		4. 4 LCD viewing angle defect.	Major										
		4. 5 Current consumption exceeds product specifications.	Major										
05	Dot defect (Bright dot 、 Dark dot) On -display	<table border="1"> <thead> <tr> <th>Item</th> <th>Acceptance (Q'ty)</th> </tr> </thead> <tbody> <tr> <td>Bright Dot</td> <td>≤ 4</td> </tr> <tr> <td>Dark Dot</td> <td>≤ 5</td> </tr> <tr> <td>Joint Dot</td> <td>≤ 3</td> </tr> <tr> <td>Total</td> <td>≤ 7</td> </tr> </tbody> </table>	Item	Acceptance (Q'ty)	Bright Dot	≤ 4	Dark Dot	≤ 5	Joint Dot	≤ 3	Total	≤ 7	Minor
		Item	Acceptance (Q'ty)										
		Bright Dot	≤ 4										
		Dark Dot	≤ 5										
		Joint Dot	≤ 3										
Total	≤ 7												
5. 1 Inspection pattern : full white , full black , Red , Green and blue screens.													
5. 2 It is defined as dot defect if defect area $> 1/2$ dot.													
5. 3 The distance between two dot defect ≥ 5 mm.													

◆ Specification For TFT-LCD Module 3.5" ~10" :

(Ver.B01)

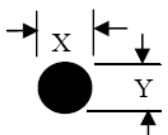
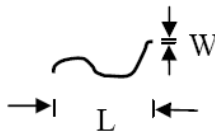
NO	Item	Criterion	Level																																								
06	<p>Black or white dot、scratch、contamination</p> <p>Round type</p>  <p>$\Phi = (x+y) / 2$</p> <p>Line type</p> 	<p>6.1 Round type (Non-display or display) :</p> <table border="1"> <thead> <tr> <th rowspan="2">Dimension (diameter : Φ)</th> <th colspan="2">Acceptance (Q'ty)</th> </tr> <tr> <th>A area</th> <th>B area</th> </tr> </thead> <tbody> <tr> <td>$\Phi \leq 0.25$</td> <td colspan="2">Ignore</td> </tr> <tr> <td>$0.25 < \Phi \leq 0.50$</td> <td>5</td> <td rowspan="3">Ignore</td> </tr> <tr> <td>$\Phi > 0.50$</td> <td>0</td> </tr> <tr> <td>Total</td> <td>5</td> </tr> </tbody> </table> <p>6.2 Line type(Non-display or display) :</p> <table border="1"> <thead> <tr> <th rowspan="2">Length (L)</th> <th rowspan="2">Width (W)</th> <th colspan="2">Acceptance (Q'ty)</th> </tr> <tr> <th>A area</th> <th>B area</th> </tr> </thead> <tbody> <tr> <td>--</td> <td>$W \leq 0.03$</td> <td colspan="2">Ignore</td> </tr> <tr> <td>$L \leq 10.0$</td> <td>$0.03 < W \leq 0.05$</td> <td>4</td> <td rowspan="3">Ignore</td> </tr> <tr> <td>$L \leq 5.0$</td> <td>$0.05 < W \leq 0.10$</td> <td>2</td> </tr> <tr> <td>--</td> <td>$W > 0.10$</td> <td colspan="2">As round type</td> </tr> <tr> <td colspan="2">Total</td> <td>5</td> <td></td> </tr> </tbody> </table>	Dimension (diameter : Φ)	Acceptance (Q'ty)		A area	B area	$\Phi \leq 0.25$	Ignore		$0.25 < \Phi \leq 0.50$	5	Ignore	$\Phi > 0.50$	0	Total	5	Length (L)	Width (W)	Acceptance (Q'ty)		A area	B area	--	$W \leq 0.03$	Ignore		$L \leq 10.0$	$0.03 < W \leq 0.05$	4	Ignore	$L \leq 5.0$	$0.05 < W \leq 0.10$	2	--	$W > 0.10$	As round type		Total		5		Minor
Dimension (diameter : Φ)	Acceptance (Q'ty)																																										
	A area	B area																																									
$\Phi \leq 0.25$	Ignore																																										
$0.25 < \Phi \leq 0.50$	5	Ignore																																									
$\Phi > 0.50$	0																																										
Total	5																																										
Length (L)	Width (W)	Acceptance (Q'ty)																																									
		A area	B area																																								
--	$W \leq 0.03$	Ignore																																									
$L \leq 10.0$	$0.03 < W \leq 0.05$	4	Ignore																																								
$L \leq 5.0$	$0.05 < W \leq 0.10$	2																																									
--	$W > 0.10$	As round type																																									
Total		5																																									
07	<p>Polarizer Bubble</p>	<table border="1"> <thead> <tr> <th rowspan="2">Dimension (diameter : Φ)</th> <th colspan="2">Acceptance (Q'ty)</th> </tr> <tr> <th>A area</th> <th>B area</th> </tr> </thead> <tbody> <tr> <td>$\Phi \leq 0.25$</td> <td colspan="2">Ignore</td> </tr> <tr> <td>$0.25 < \Phi \leq 0.50$</td> <td>4</td> <td rowspan="3">Ignore</td> </tr> <tr> <td>$0.50 < \Phi \leq 0.80$</td> <td>1</td> </tr> <tr> <td>$\Phi > 0.80$</td> <td>0</td> </tr> <tr> <td>Total</td> <td>5</td> <td></td> </tr> </tbody> </table>	Dimension (diameter : Φ)	Acceptance (Q'ty)		A area	B area	$\Phi \leq 0.25$	Ignore		$0.25 < \Phi \leq 0.50$	4	Ignore	$0.50 < \Phi \leq 0.80$	1	$\Phi > 0.80$	0	Total	5		Minor																						
Dimension (diameter : Φ)	Acceptance (Q'ty)																																										
	A area	B area																																									
$\Phi \leq 0.25$	Ignore																																										
$0.25 < \Phi \leq 0.50$	4	Ignore																																									
$0.50 < \Phi \leq 0.80$	1																																										
$\Phi > 0.80$	0																																										
Total	5																																										

◆ Specification For TFT-LCD Module 3.5" ~10" :

(Ver.B01)

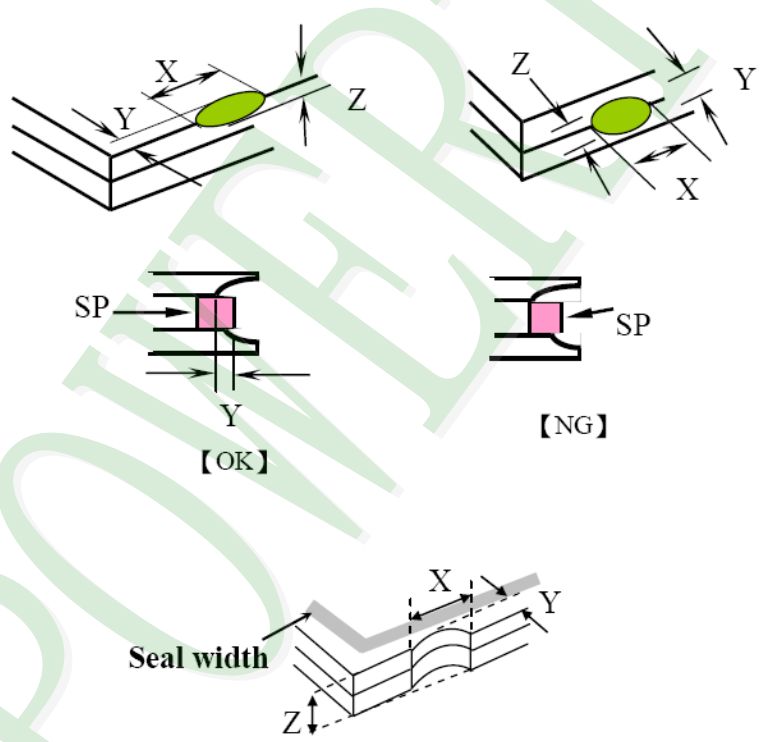
NO	Item	Criterion	Level									
08	The crack of glass	<p>Symbols :</p> <p>X : The length of crack Z : The thickness of crack t : The thickness of glass</p> <p>Y : The width of crack. W : terminal length a : LCD side length</p> <hr/> <p>8.1 General glass chip : 8.1.1 Chip on panel surface and crack between panels:</p>  <table border="1" data-bbox="542 1545 1340 1836"> <thead> <tr> <th>X</th> <th>Y</th> <th>Z</th> </tr> </thead> <tbody> <tr> <td>$\leq a$</td> <td>Crack can't enter viewing area</td> <td>$\leq 1/2 t$</td> </tr> <tr> <td>$\leq a$</td> <td>Crack can't exceed the half of SP width.</td> <td>$1/2 t < Z \leq 2 t$</td> </tr> </tbody> </table>	X	Y	Z	$\leq a$	Crack can't enter viewing area	$\leq 1/2 t$	$\leq a$	Crack can't exceed the half of SP width.	$1/2 t < Z \leq 2 t$	Minor
X	Y	Z										
$\leq a$	Crack can't enter viewing area	$\leq 1/2 t$										
$\leq a$	Crack can't exceed the half of SP width.	$1/2 t < Z \leq 2 t$										

◆ Specification For TFT-LCD Module 3.5" ~10" :

(Ver.B01)

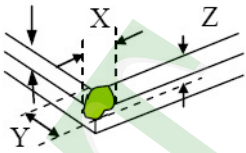
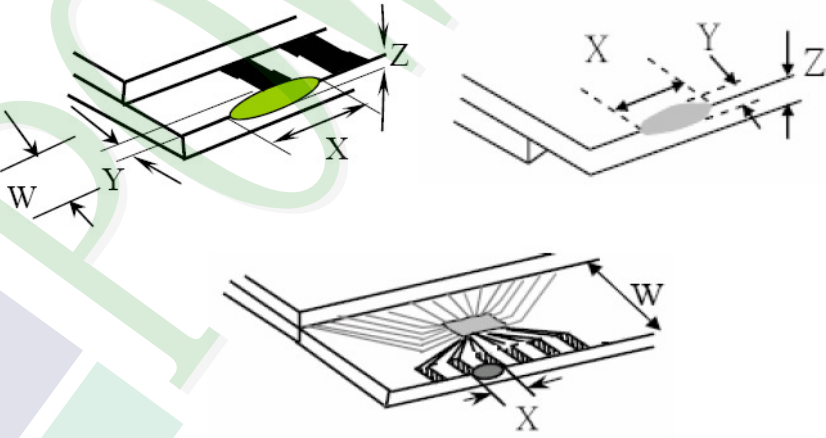
NO	Item	Criterion	Level												
08	The crack of glass	<p>Symbols :</p> <p>X : The length of crack Z : The thickness of crack t : The thickness of glass</p> <p>Y : The width of crack. W : terminal length a : LCD side length</p> <hr/> <p>8.1.2 Corner crack :</p>  <table border="1" data-bbox="525 757 1332 1048"> <thead> <tr> <th>X</th> <th>Y</th> <th>Z</th> </tr> </thead> <tbody> <tr> <td>$\leq 1/5 a$</td> <td>Crack can't enter viewing area</td> <td>$Z \leq 1/2 t$</td> </tr> <tr> <td>$\leq 1/5 a$</td> <td>Crack can't exceed the half of SP width.</td> <td>$1/2 t < Z \leq 2 t$</td> </tr> </tbody> </table>	X	Y	Z	$\leq 1/5 a$	Crack can't enter viewing area	$Z \leq 1/2 t$	$\leq 1/5 a$	Crack can't exceed the half of SP width.	$1/2 t < Z \leq 2 t$				
		X	Y	Z											
$\leq 1/5 a$	Crack can't enter viewing area	$Z \leq 1/2 t$													
$\leq 1/5 a$	Crack can't exceed the half of SP width.	$1/2 t < Z \leq 2 t$													
		<p>8.2 Protrusion over terminal :</p> <p>8.2.1 Chip on electrode pad :</p>  <table border="1" data-bbox="563 1680 1342 1850"> <thead> <tr> <th></th> <th>X</th> <th>Y</th> <th>Z</th> </tr> </thead> <tbody> <tr> <td>Front</td> <td>$\leq a$</td> <td>$\leq 1/2 W$</td> <td>$\leq t$</td> </tr> <tr> <td>Back</td> <td>$\leq a$</td> <td>$\leq W$</td> <td>$\leq 1/2 t$</td> </tr> </tbody> </table>		X	Y	Z	Front	$\leq a$	$\leq 1/2 W$	$\leq t$	Back	$\leq a$	$\leq W$	$\leq 1/2 t$	Minor
	X	Y	Z												
Front	$\leq a$	$\leq 1/2 W$	$\leq t$												
Back	$\leq a$	$\leq W$	$\leq 1/2 t$												

◆ Specification For TFT-LCD Module 3.5" ~10" :

(Ver.B01)

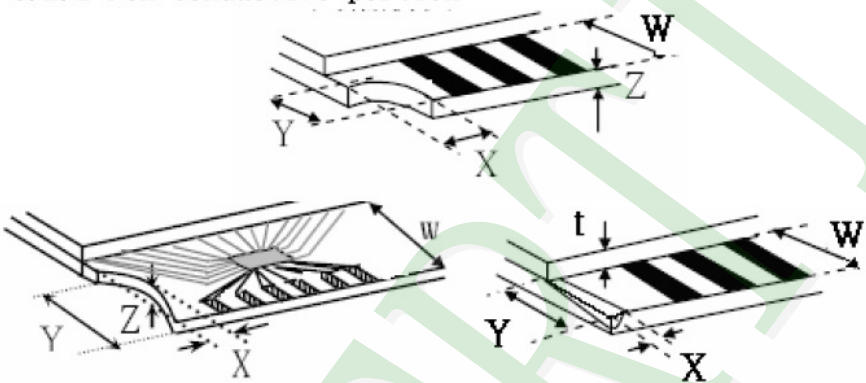
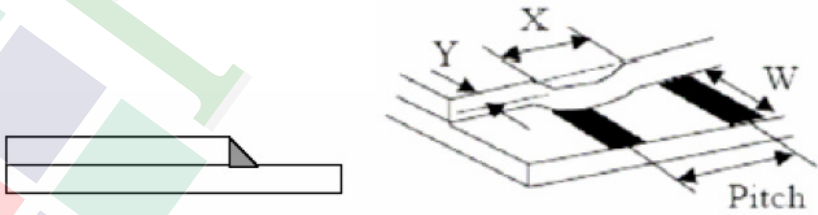
NO	Item	Criterion	Level												
08	The crack of glass	<p>Symbols :</p> <p>X : The length of crack Y : The width of crack. Z : The thickness of crack W : terminal length t : The thickness of glass a : LCD side length</p> <hr/> <p>8.2.2 Non-conductive portion :</p>  <table border="1" data-bbox="630 963 1260 1120"> <thead> <tr> <th>X</th> <th>Y</th> <th>Z</th> </tr> </thead> <tbody> <tr> <td>$\leq 1/3 a$</td> <td>$\leq W$</td> <td>$\leq t$</td> </tr> </tbody> </table> <p>⊙ If the chipped area touches the ITO terminal, over 2/3 of the ITO must remain and be inspected according to electrode terminal specifications.</p> <p>8.2.3 Glass remain :</p>  <table border="1" data-bbox="550 1736 1244 1881"> <thead> <tr> <th>X</th> <th>Y</th> <th>Z</th> </tr> </thead> <tbody> <tr> <td>$\leq a$</td> <td>$\leq 1/3 W$</td> <td>$\leq t$</td> </tr> </tbody> </table>	X	Y	Z	$\leq 1/3 a$	$\leq W$	$\leq t$	X	Y	Z	$\leq a$	$\leq 1/3 W$	$\leq t$	Minor
		X	Y	Z											
$\leq 1/3 a$	$\leq W$	$\leq t$													
X	Y	Z													
$\leq a$	$\leq 1/3 W$	$\leq t$													



◆Specification For TFT-LCD Module 3.5" ~10" :

(Ver.B01)

NO	Item	Criterion	Level
09	Backlight elements	9. 1 Backlight can't work normally.	Major
		9. 2 Backlight doesn't light or color is wrong.	Major
		9. 3 Illumination source flickers when lit.	Major
10	General appearance	10. 1 Pin type 、 quantity 、 dimension must match type in structure diagram.	Major
		10. 2 No short circuits in components on PCB or FPC .	Major
		10. 3 Parts on PCB or FPC must be the same as on the production characteristic chart .There should be no wrong parts , missing parts or excess parts.	Major
		10. 4 Product packaging must the same as specified on packaging specification sheet.	Minor
		10. 5 The folding and peeled off in polarizer are not acceptable.	Minor
		10. 6 The PCB or FPC between B/L assembled distance(PCB or FPC) is ≤ 1.5 mm.	Minor

5. PRECAUTION RELATING PRODUCT HANDLING

5.1 SAFETY

- 5.1.1 If the LCD panel breaks , be careful not to get the liquid crystal to touch your skin.
- 5.1.2 If the liquid crystal touches your skin or clothes , please wash it off immediately by using soap and water.

5.2 HANDLING

- 5.2.1 Avoid any strong mechanical shock which can break the glass.
- 5.2.2 Avoid static electricity which can damage the CMOS LSI—When working with the module , be sure to ground your body and any electrical equipment you may be using.
- 5.2.3 Do not remove the panel or frame from the module.
- 5.2.4 The polarizing plate of the display is very fragile. So , please handle it very carefully ,do not touch , push or rub the exposed polarizing with anything harder than an HB pencil lead (glass , tweezers , etc.)
- 5.2.5 Do not wipe the polarizing plate with a dry cloth , as it may easily scratch the surface of plate.
- 5.2.6 Do not touch the display area with bare hands , this will stain the display area.
- 5.2.7 Do not use ketonics solvent & aromatic solvent. Use with a soft cloth soaked with a cleaning naphtha solvent.
- 5.2.8 To control temperature and time of soldering is $320\pm 10^{\circ}\text{C}$ and 3-5 sec.
- 5.2.9 To avoid liquid (include organic solvent) stained on LCM .

5.3 STORAGE

- 5.3.1 Store the panel or module in a dark place where the temperature is $25^{\circ}\text{C} \pm 5^{\circ}\text{C}$ and the humidity is below 65% RH.
- 5.3.2 Do not place the module near organics solvents or corrosive gases.
- 5.3.3 Do not crush , shake , or jolt the module.

5.4 TERMS OF WARRANTY

- 5.4.1 Applicable warrant period
The period is within thirteen months since the date of shipping out under normal using and storage conditions.
- 5.4.2 Unaccepted responsibility
This product has been manufactured to your company's specification as a part for use in your company's general electronic products. It is guaranteed to perform according to delivery specifications. For any other use apart from general electronic equipment , we cannot take responsibility if the product is used in nuclear power control equipment , aerospace equipment , fire and security systems or any other applications in which there is a direct risk to human life and where extremely high levels of reliability are required.

1. 包裝材料規格表 (Packaging Material) : (per carton)

No.	Item	Model	Dimensions (mm)	1Pcs Weight	Quantity	Total Weight
1	成品 (LCM)	PH800480T024-IDA01	121.0 X 75.9	0.0606	144	8.7264
2	多層薄膜(1)POF	OTFILM0BA03ABA	19"X350X0.015	—	6	—
3	舒美墊(3) EPE	FOAM000000180	130.0 X 90.0 X 1	0.0002	144	0.0288
4	TRAY 盤 (2)Tray	TY00000000308	352 X 260 X 12.8	0.0965	42	4.053
5	舒美墊(4) EPE	FOAM000000047	350 X 255 X 5	0.011	6	0.066
6	內盒(5)Product Box	BX36627063ABBA	383 X 270 X 66	0.182	6	1.092
7	保利龍板(6)Polylon board	OTPLB00PL08ABA	550 X 393 X 20	0.0284	2	0.0568
8	外紙箱(7)Carton	BX57041027CCBA	570 X 410 X 265	1.0	1	1.0
9						

2. 一整箱總重量 (Total LCD Weight in carton) : 15.02 Kg±10%

3. 單箱數量規格表 (Packaging Specifications and Quantity) :

(1) LCM quantity per box : no per tray	4	x no of tray	6	=	24
(2) Total LCM quantity in carton : quantity per box	24	x no of boxes	6	=	144

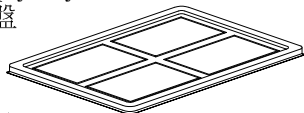
Use empty tray
空盤

+

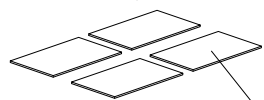

(3)EPE

Put products into the tray

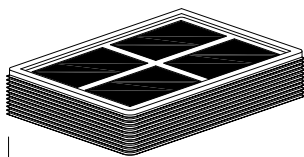

↓

Tray stacking

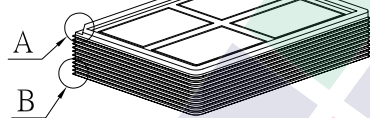

A

B

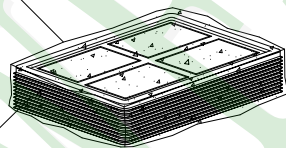
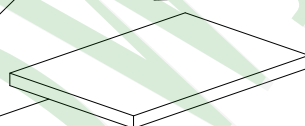
(1)多層薄膜
POF(2)TRAY 盤
Tray

(4)EPE

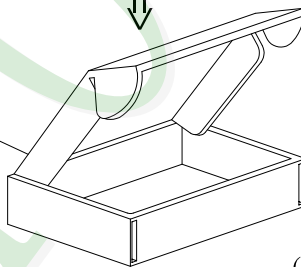
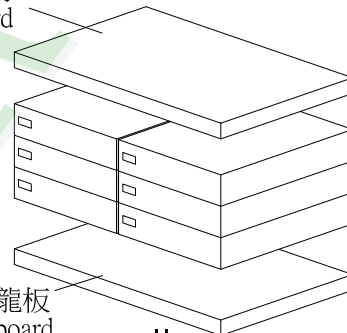
(5)內盒
Product Box(6)保利龍板
Polylon board(6)保利龍板
Polylon board

↓

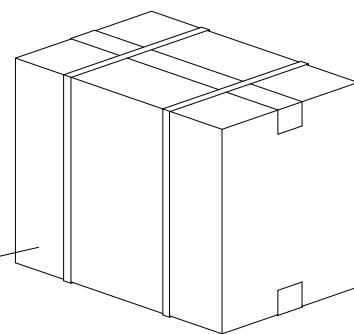
(7)外紙箱
Carton

特 記 事 項 (REMARK)

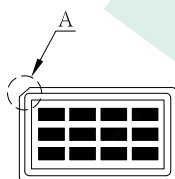

斜角

Detail B

圓角

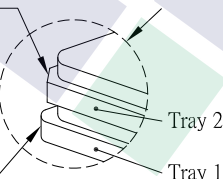

Tray 2

Tray 1

4. TRAY盤相疊時,需旋轉180度,請詳見B視圖
Rotate tray 180 degrees and place on top of stack.
Check the tray stack using Fig. B.