

SPECIFICATIONS

CUSTOMER : PTC
SAMPLE CODE : SH320240T023-IHC
MASS PRODUCTION CODE : PH320240T023-IHC
SAMPLE VERSION : 01
SPECIFICATIONS EDITION : 006
DRAWING NO. (Ver.) : JLMD-PH320240T023-IHC_005
PACKAGING NO. (Ver.) : JPKG-PH320240T023-IHC_001

Customer Approved

Date:

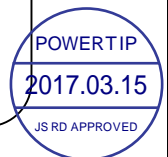

| Approved | Checked | Designer |
|----------|---------|----------|
| 閔偉 | 張久慧 | 劉進 |

- Preliminary specification for design input
 Specification for sample approval

POWERTIP TECH. CORP.

Headquarters: No.8, 6th Road, Taichung Industrial Park,
Taichung, Taiwan
台中市 407 工業區六路 8 號

TEL: 886-4-2355-8168

FAX: 886-4-2355-8166

E-mail: sales@powertip.com.tw

[Http://www.powertip.com.tw](http://www.powertip.com.tw)

Contents

1. SPECIFICATIONS

- 1.1 Features
- 1.2 Mechanical Specifications
- 1.3 Absolute Maximum Ratings
- 1.4 DC Electrical Characteristics
- 1.5 Optical Characteristics
- 1.6 Backlight Characteristics
- 1.7 Touch Panel Characteristics

2. MODULE STRUCTURE

- 2.1 Counter Drawing
- 2.2 Interface Pin Description
- 2.3 Timing Characteristics
- 2.4 Power Sequence

3. QUALITY ASSURANCE SYSTEM

- 3.1 Quality Assurance Flow Chart
- 3.2 Inspection Specification

4. RELIABILITY TEST

- 4.1 Reliability Test Condition

5. PRECAUTION RELATING PRODUCT HANDLING

- 5.1 Safety
- 5.2 Handling
- 5.3 Storage
- 5.4 Terms of Warranty

Appendix : LCM Drawing
Packaging

Note : For detailed information please refer to IC data sheet :

Primacy(TFT LCD): Himax: HX8238-D

1. SPECIFICATIONS

1.1 Features

| Item | Standard Value |
|-----------------------------------|---|
| Display Resolution | 320 * (RGB) * 240 Dots |
| LCD Type | a-Si TFT , Normally white , Transmissive type |
| Touch panel | Projective capacitive touch panel True Multi-touch with up to 5 Points of Absolution |
| Screen size(inch) | 3.5 inch |
| Viewing Direction | 6 O'clock |
| Color configuration | R.G.B. Vertical Stripe |
| Backlight Type | LED B/L |
| Weight | - |
| Interface | 24 Bits RGB Interface |
| Other (controller / driver IC) | Himax: HX8238-D |
| ROHS | THIS PRODUCT CONFORMS THE ROHS OF PTC Detail information please refer website : http://www.powertip.com.tw/news.php?area_id_view=1085560481/ |

1.2 Mechanical Specifications

| Item | Standard Value | Unit |
|------------------------|--------------------------------|------|
| Outline Dimension(T/P) | 84.02(W) x 75.36 (L) x 4.6 (H) | mm |

LCD panel

| Item | Standard Value | Unit |
|-------------|-----------------------|------|
| Active Area | 70.08 (W) * 52.56 (L) | mm |

Touch panel

| Item | Standard Value | Unit |
|--------------|-----------------------|------|
| Viewing Area | 71.68 (W) * 54.16 (L) | mm |

Note : For detailed information please refer to LCM drawing.

1.3 Absolute Maximum Ratings

Module

| Item | Symbol | Condition | Min. | Max. | Unit | Remark |
|-----------------------|-----------------|-----------|------|-------|------|--------|
| Power Supply Voltage | VDD | GND=0 | -0.3 | +3.96 | V | - |
| Power Supply Voltage | VCC | GND=0 | -0.3 | +23.0 | V | |
| Operating Temperature | T _{OP} | - | -20 | +70 | °C | |
| Storage Temperature | T _{ST} | - | -30 | +80 | °C | |

The absolute maximum rating values of this product are not allowed to be exceeded at any times. Should a module be used with any of the absolute maximum ratings exceeded, the characteristics of the module may not be recovered, or in an extreme case, the module may be permanently destroyed.

1.4 DC Electrical Characteristics

Module

T_a = 25°C

| Item | Symbol | Condition | Min. | Typ. | Max. | Unit |
|-----------------------------------|-----------------|--------------|--------|------|--------|------|
| Power Supply for TFT Panel | VDD | GND=0V | 3.0 | 3.3 | 3.6 | V |
| Power Supply for Backlight Unit | VCC | GND=0V | 5 | 12 | 14 | V |
| Input Voltage for TFT Panel | V _{IH} | GND=0V | 0.7VDD | - | VDD | V |
| | V _{IL} | GND=0V | 0 | - | 0.3VDD | V |
| Supply Current for TFT Panel | IDD | IDD@VDD=3.3V | - | 11 | 17 | mA |
| Supply Current for Backlight Unit | ICC | ICC@VCC=5V | - | 100 | 150 | mA |
| | | ICC@VCC=12V | - | 50 | 75 | mA |
| Input Voltage for PWM Signal | VPH | GND=0V | 1.2 | - | - | V |
| | VPL | GND=0V | - | - | 0.4 | V |
| Dimming Clock Rate | fP | GND=0V | 5 | - | 100 | KHz |

1.5 Optical Characteristics

VDD=3.3V, Ta=25°C

| Item | Symbol | Condition | Min. | Typ. | Max. | unit | - | |
|--|------------|--------------------------------------|--------------------------------------|------|------|-------------------|-------|-------|
| Response time | Tr + Tf | - | - | 40 | 60 | ms | Note2 | |
| Viewing angle | Top | $\theta+$ | CR \geq 10 | - | 60 | - | Deg. | Note4 |
| | Bottom | $\theta-$ | | - | 60 | - | | |
| | Left | θ_L | | - | 60 | - | | |
| | Right | θ_R | | - | 60 | - | | |
| Contrast ratio | CR | - | 500 | 600 | - | - | Note3 | |
| Color of CIE Coordinate (LCD & B/L & T/P) | White | X | VCC=12V PWM="High" (Duty=100%) | 0.27 | 0.32 | 0.37 | - | Note1 |
| | | Y | | 0.30 | 0.35 | 0.40 | | |
| | Red | X | | 0.59 | 0.64 | 0.69 | | |
| | | Y | | 0.29 | 0.34 | 0.39 | | |
| | Green | X | | 0.29 | 0.34 | 0.39 | | |
| | | Y | | 0.56 | 0.61 | 0.66 | | |
| | Blue | X | | 0.09 | 0.14 | 0.19 | | |
| | | Y | | 0.03 | 0.08 | 0.13 | | |
| Average Brightness Pattern=white display (LCD & B/L & T/P)*1 | IV | VCC=12V PWM="High" (Duty=100%) | 680 | 850 | - | cd/m ² | | |
| Uniformity (LCD & B/L & T/P)*2 | ΔB | | 70 | - | - | % | | |

Note 1:

*1 : $\Delta B = B(\min) / B(\max) * 100\%$

*2 : Measurement Condition for Optical Characteristics:

- a : Environment: $25^{\circ}\text{C} \pm 5^{\circ}\text{C} / 60 \pm 20\% \text{R.H}$, no wind , dark room below 10 Lux at typical lamp current and typical operating frequency.
- b : Measurement Distance: $500 \pm 50 \text{ mm}$, ($\theta = 0^{\circ}$)
- c : Equipment: TOPCON BM-7 fast , (field 1°) , after 10 minutes operation.
- d : The uncertainty of the C.I.E coordinate measurement ± 0.01 , Average Brightness $\pm 4\%$

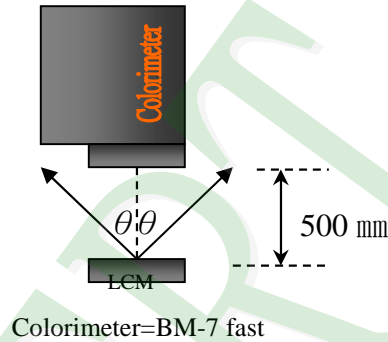
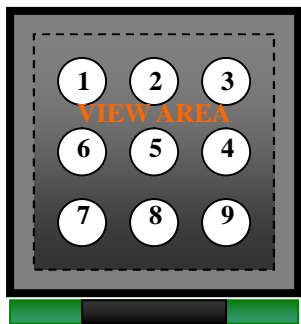

To be measured at the center area of panel with a viewing cone of 1° by Topcon luminance meter BM-7, after 10 minutes operation (module)

Note2: Definition of response time:

The output signals of photo detector are measured when the input signals are changed from "black" to "white"(falling time) and from "white" to "black"(rising time), respectively. The response time is defined as the time interval between the 10% and 90% of Amplitudes.

Refer to figure as below:

Normally White



Normally Black

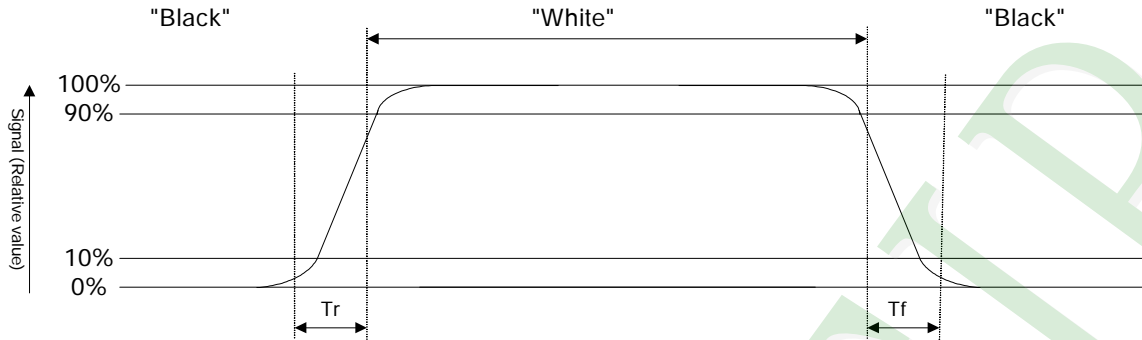

Note3: Definition of contrast ratio:

Contrast ratio is calculated with the following formula

$$\text{Contrast ratio (CR)} = \frac{\text{Photo detector output when LCD is at "White" state}}{\text{Photo detector output when LCD is at "Black" state}}$$

Note4: Definition of viewing angle:

Refer to figure as below:

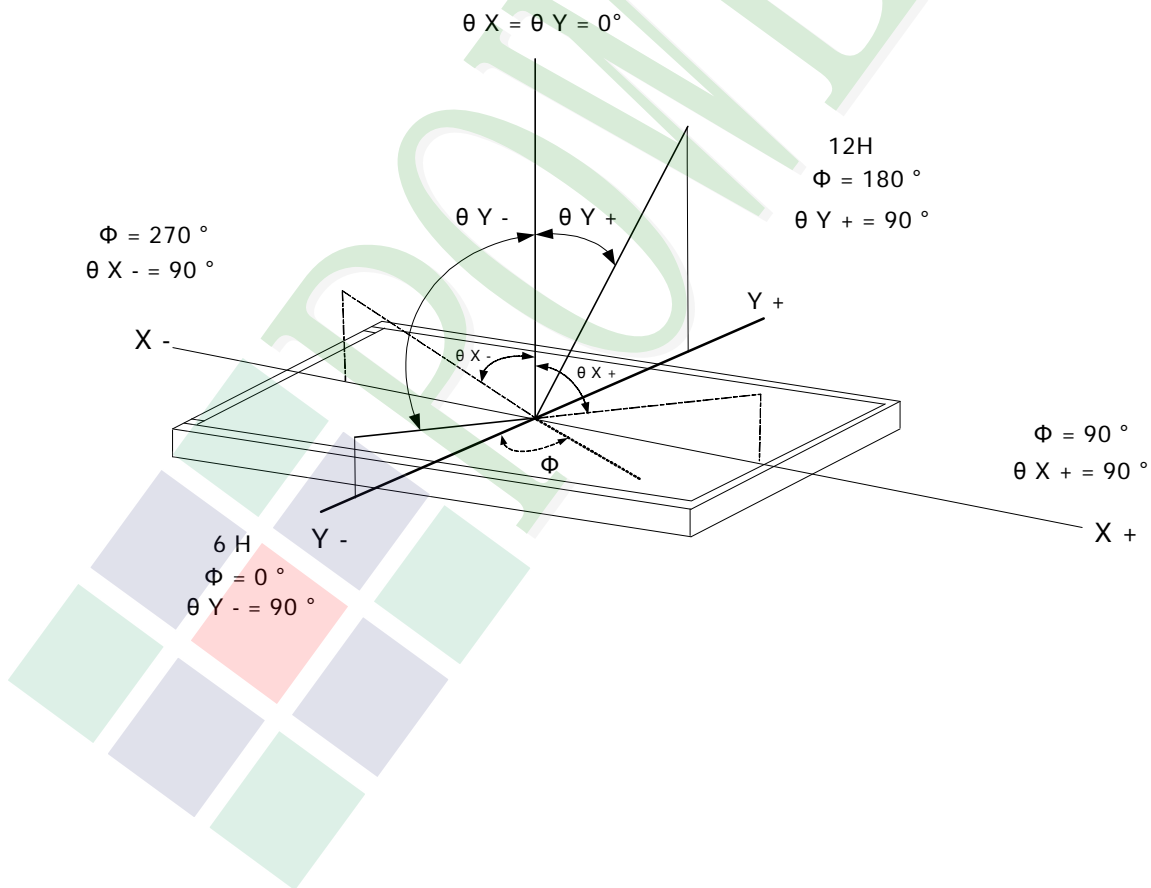

1.6 Backlight Characteristics

Maximum Ratings

| Item | Symbol | Min. | Max. | Unit | Remark |
|---------------------|--------|------|------|------|---------|
| LED Forward Current | I_F | | 30 | mA | One LED |
| LED Reverse Voltage | V_R | | 5 | V | |

Electrical / Optical Characteristics

| Item | Symbol | Min. | Typ. | Max. | Unit | Remark |
|---------------|--------|-------|------|------|------|--------|
| LED Voltage | V_L | 18 | 19 | 19.8 | V | Note1 |
| LED Current | I_L | - | 20 | - | mA | - |
| LED life time | - | 50000 | - | - | Hr | Note2 |

Note 1: The LED Supply Voltage is defined by the number of LED at $T_a=25^\circ\text{C}$ and $I_L=20\text{mA}$.

Note 2: The "LED life time" is defined as the module brightness decrease to 50% original brightness at $T_a=25^\circ\text{C}$ and $I_L=20\text{mA}$. The LED life time could be decreased if operating I_L is larger than 20 mA.

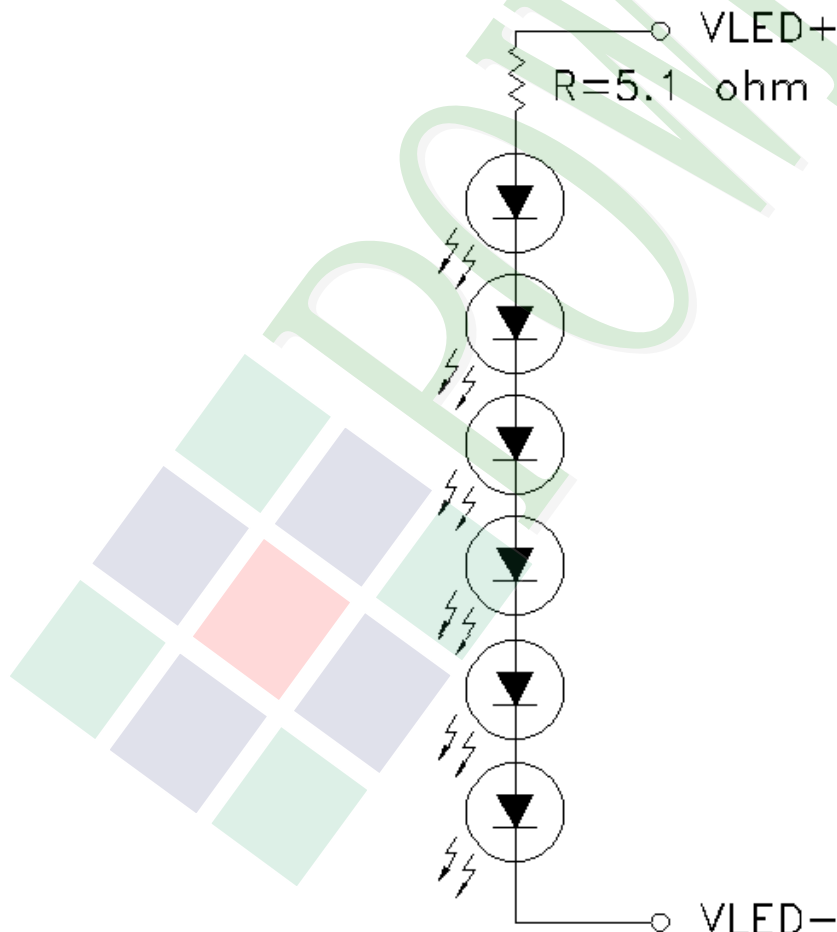

1.7 Touch Panel Characteristics

Features

| Item | Standard Value |
|------------------|-----------------------------------|
| Touch Panel Size | 3.5" |
| Touch type | Projective capacitive touch panel |
| Input Method | Finger / 5 Points touch |
| Output Interface | I ² C |
| IC | ST1633 |

Mechanical Specifications

| Item | Standard Value | Unit |
|---------------------------|-----------------------------|------|
| Viewing Area | 71.68 mm (W) x 54.16 mm (H) | mm |
| Number of sensing channel | 12 (W) x 10 (H) | mm |

Absolute Maximum Ratings

| Item | Symbol | Condition | Min. | Max. | Unit |
|-----------------------|-----------------|-----------|------|------|------|
| Supply voltage | TPVDD | - | -0.3 | +6.0 | V |
| Operating Temperature | T _{OP} | - | -20 | +70 | °C |
| Storage Temperature | T _{ST} | - | -30 | +80 | °C |

DC Electrical Characteristics

| Item | Symbol | Condition | Min. | Typ. | Max. | Unit |
|----------------------|--------|-----------|------------|------|------------|------|
| Power Supply Voltage | TPVDD | - | 2.8 | 3.3 | 3.6 | V |
| Input High Voltage | TPVIH | - | 0.85 TPVDD | - | - | V |
| Input Low Voltage | TPVIL | - | - | - | 0.15 TPVDD | V |

Touch Panel IC Read/Write description & Register Mapping

Reference : Sitronix Touch Driver Porting Reference Guide.

2. MODULE STRUCTURE

2.1 Counter Drawing

2.1.1 LCM Mechanical Diagram

* See Appendix

2.1.2 Block Diagram

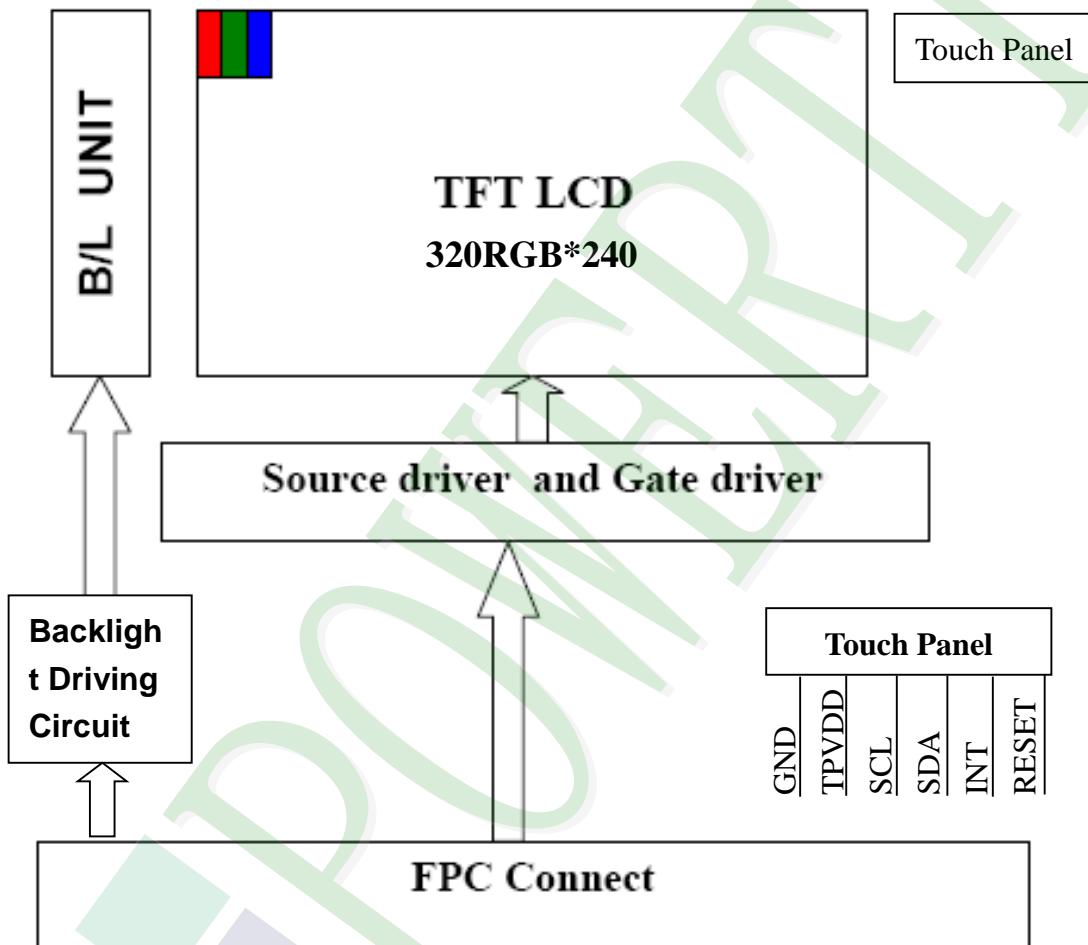

2.2 Interface Pin Description

TFT LCM Interface

| Pin No. | Symbol | Function |
|---------|--------|---|
| 1 | GND | Power ground. |
| 2 | VDD | Power for Digital Circuit. |
| 3 | VDD | Power for Digital Circuit. |
| 4 | VCC | Power For LED backlight. |
| 5 | VCC | Power For LED backlight. |
| 6 | PWM | Shutdown & Dimming control input for backlight. Do not allow this pin to float. "Hi" =100%, "Low" = 0%. |
| 7 | GND | Power ground. |
| 8 | R0 | Red Data. |
| 9 | R1 | Red Data. |
| 10 | R2 | Red Data. |
| 11 | R3 | Red Data. |
| 12 | GND | Power ground. |
| 13 | R4 | Red Data. |
| 14 | R5 | Red Data. |
| 15 | R6 | Red Data. |
| 16 | R7 | Red Data. |
| 17 | GND | Power ground. |
| 18 | G0 | Green Data. |
| 19 | G1 | Green Data. |
| 20 | G2 | Green Data. |
| 21 | G3 | Green Data. |
| 22 | GND | Power ground. |
| 23 | G4 | Green Data. |
| 24 | G5 | Green Data. |
| 25 | G6 | Green Data. |
| 26 | G7 | Green Data. |
| 27 | GND | Power ground. |
| 28 | B0 | Blue Data. |
| 29 | B1 | Blue Data. |

| Pin No. | Symbol | Function |
|---------|-----------------------|---|
| 30 | B2 | Blue Data. |
| 31 | B3 | Blue Data. |
| 32 | GND | Power ground. |
| 33 | B4 | Blue Data. |
| 34 | B5 | Blue Data. |
| 35 | B6 | Blue Data. |
| 36 | B7 | Blue Data. |
| 37 | GND | Power ground. |
| 38 | HS | Line synchronization signal. Horizontal Sync Input. |
| 39 | VS | Frame synchronization signal. Vertical Sync Input. |
| 40 | GND | Power ground. |
| 41 | DE | Display enable pin from controller. Data Input Enable. |
| 42 | GND | Power ground. |
| 43 | DCLK | Sample clock. Data will be latched at the falling edge of DCLK. |
| 44 | GND | Power ground. |
| 45 | CS / ID1 | Chip Select/ ID[4:1]These pins select LCM type. |
| 46 | SDIN / ID2 | SPI Data/ ID[4:1]These pins select LCM type. |
| 47 | SCK / ID3 | SPI Clock/ ID[4:1]These pins select LCM type. |
| 48 | DISPLAY CONTROL / ID4 | Display Enable (Hi Active) / ID[4:1]These pins select LCM type. |
| 49 | /RESET | Global Reset (Low Active). |
| 50 | GND | Power ground. |

Capacitive Touch Panel (CTP) Interface

| Pin No. | Symbol | Function |
|---------|--------|---|
| 1 | GND | Ground. |
| 2 | TPVDD | Power. |
| 3 | SCL | I ² C Clock. |
| 4 | SDA | I ² C Data. |
| 5 | INT | The interrupt from the CTP to the Host. |
| 6 | RESET | RESET. |

2.2.1 Refer Initial Code

HX8238-D register configuration is recommended to use the default value (HSP=0, VSP=0, CKP=0, DEP=0).

Note:
HSP: When HSP=0, HS(HSYNC) is negative polarity. When HSP=1, HS(HSYNC) is positive polarity.
VSP: When VSP=0, VS(VSYNC) is negative polarity. When VSP=1, VS(VSYNC) is positive polarity.
CKP: When CKP=0, data is latched in DCLK falling edge. When CKP=1, data is latched in DCLK rising edge.
DEP: When DEP=0, DE is negative polarity active. When DEP=1, DE is positive polarity active.

2.3 Timing Characteristics

2.3.1 Pixel timing for HX8238-D

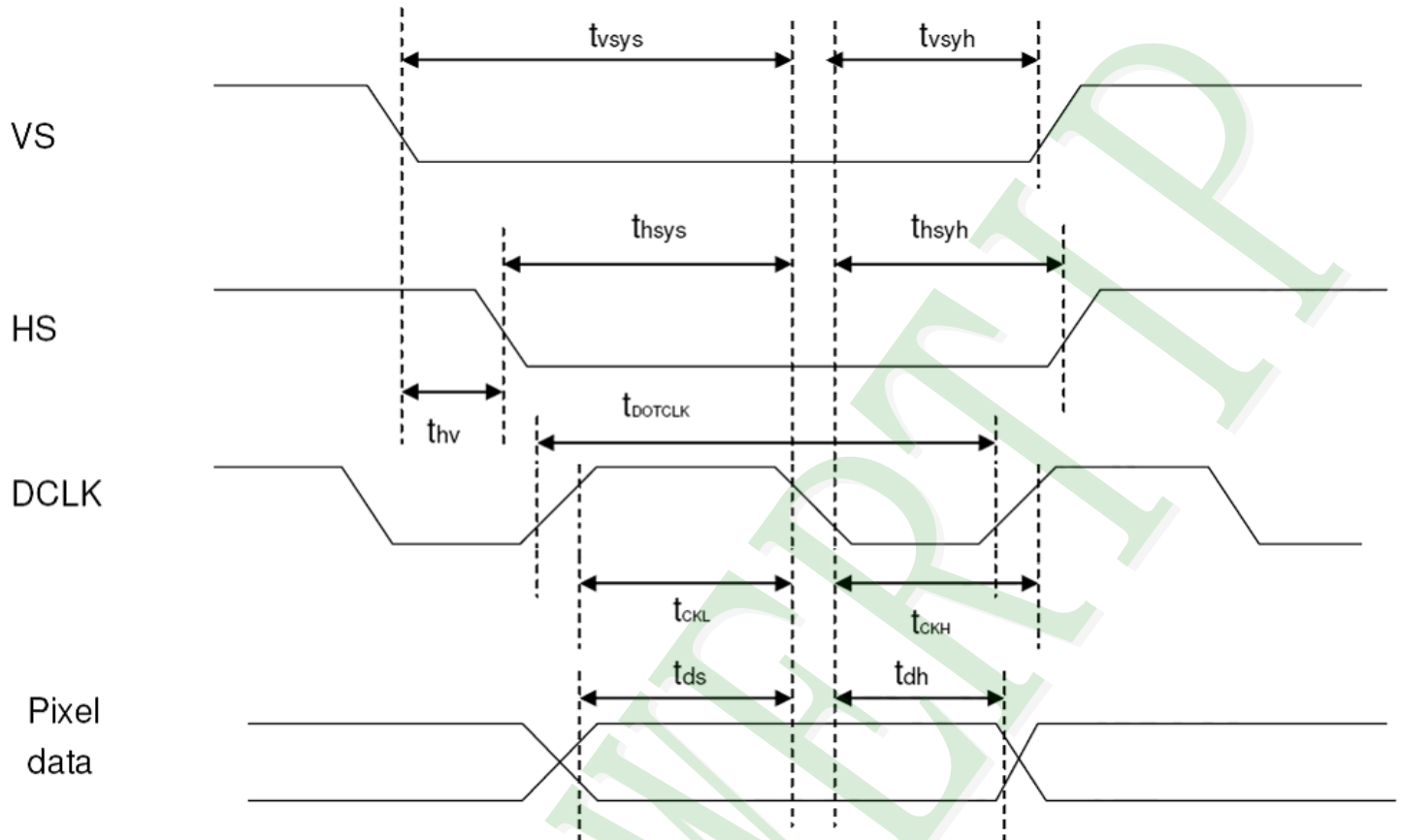

| Characteristics | Symbol | Min | Typ | Max | Unit |
|--|-------------------|-----|-----|-----|-------------------|
| DCLK Frequency | f _{DCLK} | - | 6.5 | 10 | MHz |
| DCLK Period | t _{DCLK} | 100 | 154 | - | ns |
| Vertical Sync Setup Time | t _{vsys} | 20 | - | - | ns |
| Vertical Sync Hold Time | t _{vsyh} | 20 | - | - | ns |
| Horizontal Sync Setup Time | t _{hsys} | 20 | - | - | ns |
| Horizontal Sync Hold Time | t _{hsyh} | 20 | - | - | ns |
| Phase difference of Sync Signal Falling Edge | t _{thv} | 1 | - | 240 | t _{DCLK} |
| DCLK Low Period | t _{ckl} | 50 | - | - | ns |
| DCLK High Period | t _{ckh} | 50 | - | - | ns |
| Data Setup Time | t _{ds} | 12 | - | - | ns |
| Data hold Time | t _{dh} | 12 | - | - | ns |
| Reset pulse width | t _{RES} | 10 | - | - | μs |

Note: External clock source must be provided to DOTCLK pin of HX8238-A. The driver will not operate if absent of the clocking signal.

Pixel timing

2.3.2 Data transaction timing for HX8238-D

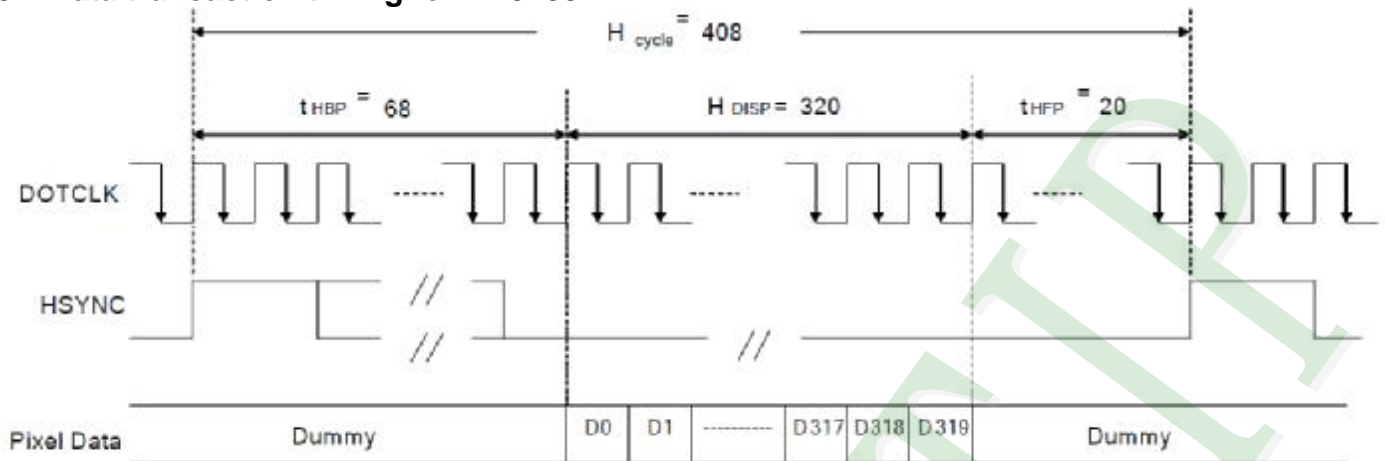

(a) Horizontal Data Transaction Timing

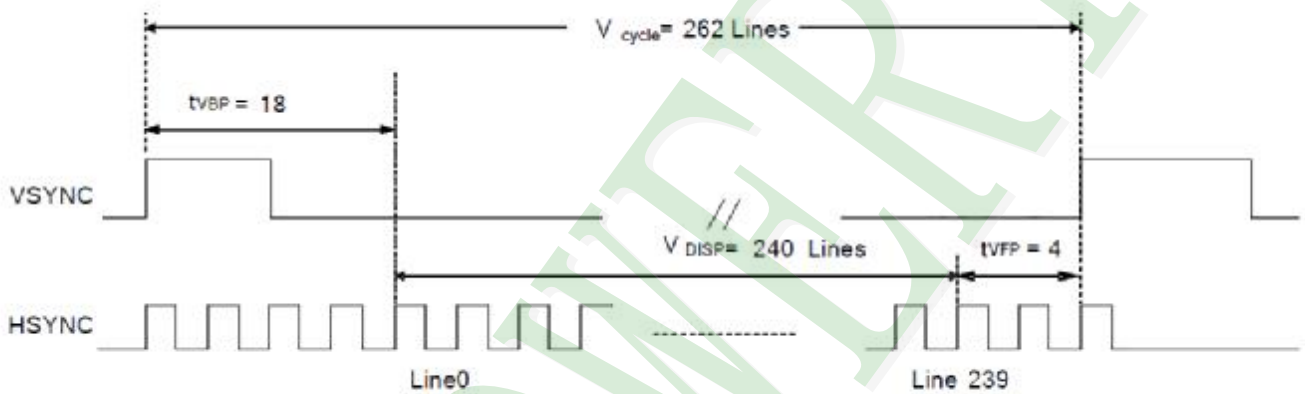

(b) Vertical Data Transaction Timing

Data transaction timing in parallel RGB (24 bit) interface (SYNC mode)

| Characteristics | Symbol | Min | Typ | Max | Unit |
|------------------------------|-------------|-----|------|-------|---------|
| DOTCLK Frequency | fDOTCLK | - | 6.5 | 10 | MHz |
| DOTCLK Period | tDOTCLK | 100 | 154 | - | ns |
| Horizontal Frequency (Line) | fH | - | 14.9 | 22.35 | KHz |
| Vertical Frequency (Refresh) | fV | - | 60 | 90 | Hz |
| Horizontal Back Porch | tHBP | - | 68 | - | tDOTCLK |
| Horizontal Front Porch | tHFP | - | 20 | - | tDOTCLK |
| Horizontal Data Start Point | tHBP | - | 68 | - | tDOTCLK |
| Horizontal Blanking Period | tHBP + tHFP | - | 88 | - | tDOTCLK |
| Horizontal Display Area | H_DISP | - | 320 | - | tDOTCLK |
| Horizontal Cycle | H_cycle | - | 408 | 450 | tDOTCLK |
| Vertical Back Porch | tVBP | - | 18 | - | Lines |
| Vertical Front Porch | tVFP | - | 4 | - | Lines |
| Vertical Data Start Point | tVBP | - | 18 | - | Lines |
| Vertical Blanking Period | tVBP + tVFP | - | 22 | - | Lines |
| Vertical Display Area | V_DISP | - | 240 | - | Lines |
| Vertical Cycle | V_cycle | - | 262 | 350 | Lines |

Data transaction timing in normal operating mode

| Characteristics | Symbol | Min. | Typ. | Max. | Unit |
|----------------------------|-------------|------|------|------|---------|
| DOTCLK Frequency | fDOTCLK | - | 6.5 | 10 | MHz |
| DOTCLK Period | tDOTCLK | 100 | 154 | - | ns |
| Horizontal Blanking Period | tHBP + tHFP | 52 | 88 | 180 | tDOTCLK |
| Horizontal Display Area | HDISP | - | 320 | - | tDOTCLK |
| Horizontal Cycle | Hcycle | 372 | 408 | 500 | tDOTCLK |
| Vertical Blanking Period | tVBP + tVFP | 2 | - | 47 | Lines |
| Vertical Display Area | VDISP | - | 240 | - | Lines |
| Vertical Cycle | Vcycle | 242 | - | 287 | Lines |

Data transaction timing in DE only operating mode

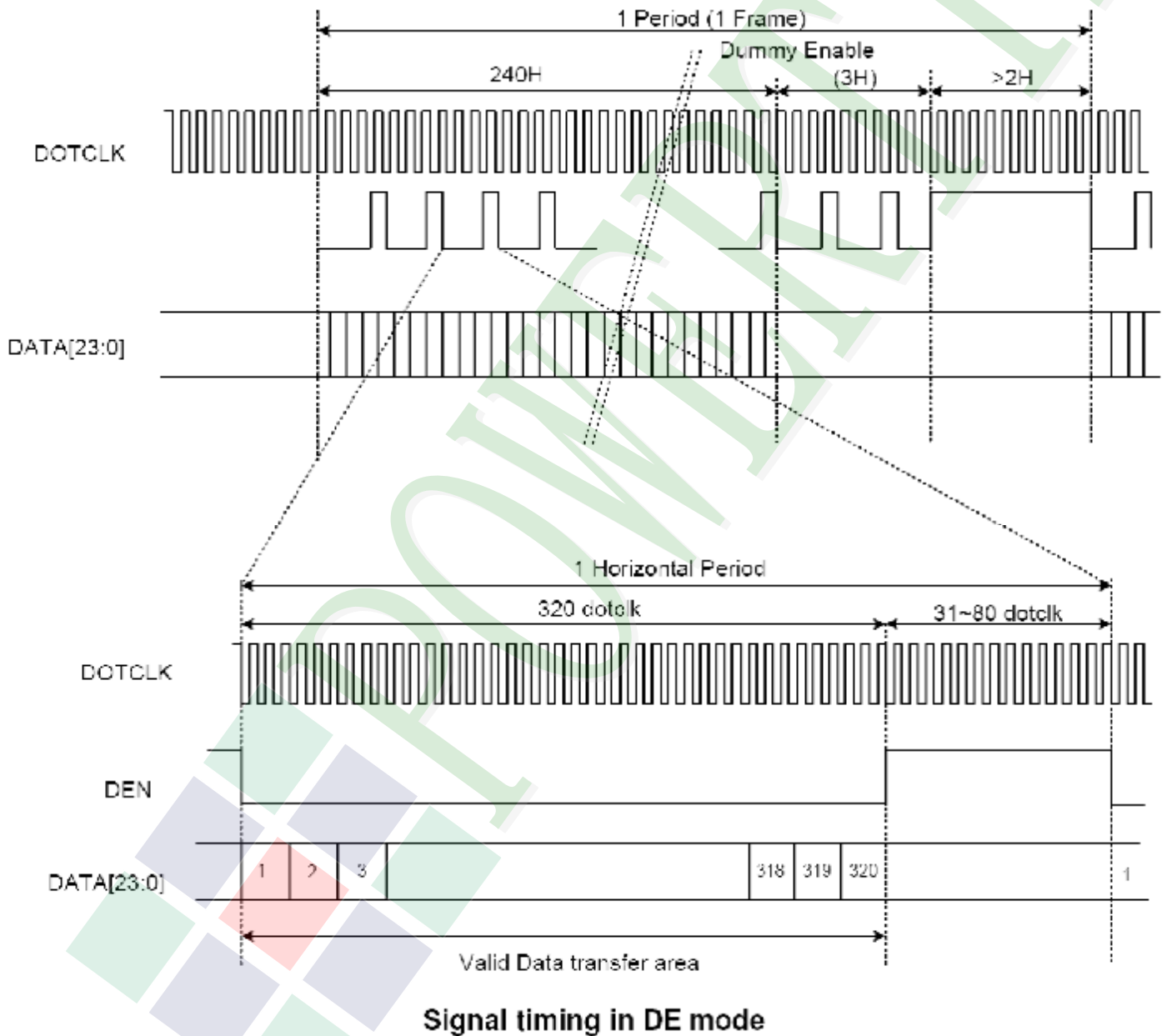

Signal timing in DE mode

2.3.3 SPI Timing Characteristics for HX8238-D

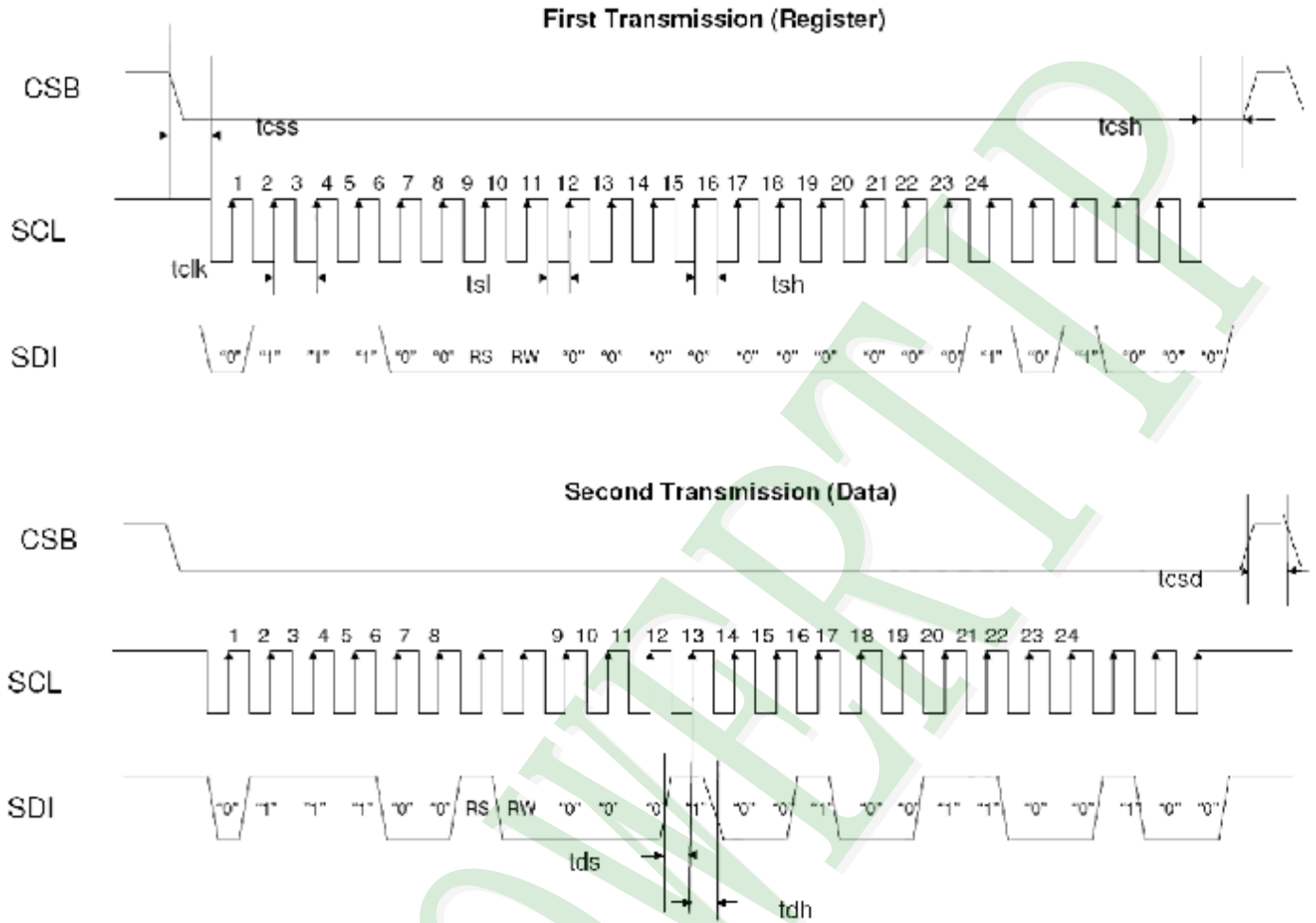

Note: The example transmit "0x1264h" to register R28h.
SPID connected to VSS.

SPI interface timing diagram & transaction example

| Characteristics | Symbol | Min | Typ | Max | Unit |
|-----------------------------|--------|-----|-----|-----|------|
| Serial Clock Frequency | tclk | - | - | 20 | MHz |
| Serial Clock Cycle Time | tclk | 50 | - | - | ns |
| Clock Low Width | tsl | 25 | - | - | ns |
| Clock High Width | tsh | 25 | - | - | ns |
| Chip Select Setup Time | tcss | 0 | - | - | ns |
| Chip Select Hold Time | tcsh | 10 | - | - | ns |
| Chip Select High Delay Time | tcshd | 20 | - | - | ns |
| Data Setup Time | tds | 5 | - | - | ns |
| Data Hold Time | tdh | 10 | - | - | ns |

SPI timing

2.4 Power Sequence

2.4.1 Power up sequence

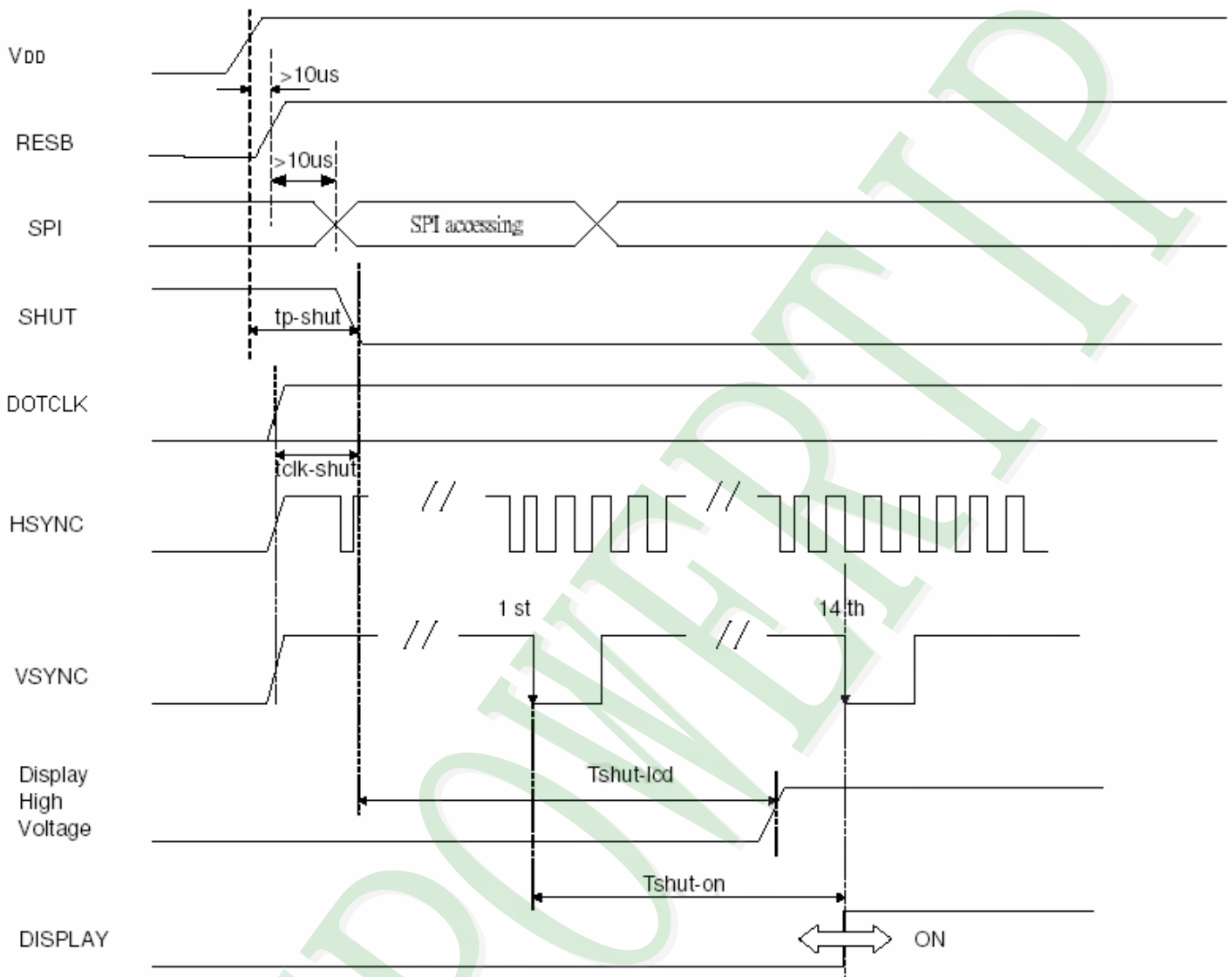

| Characteristics | Symbol | Min | Typ | Max | Units |
|--|-----------------------|-----|-----|-------|-------|
| VDD on to falling edge of SHUT | $t_{p\text{-shut}}$ | 1 | - | - | us |
| DOTCLK | $t_{\text{clk-shut}}$ | 1 | - | - | clk |
| Falling edge of SHUT to LCD power on | $t_{\text{shut-lcd}}$ | - | - | 128 | ms |
| Falling edge of SHUT to display start | $t_{\text{shut-on}}$ | - | - | 14 | frame |
| - 1 line: 408 clk | | - | 166 | 232.4 | ms |
| - 1 frame: 262 line - DOTCLK = 6.5MHz | | - | - | - | - |

Note: It is necessary to input DOTCLK before the falling edge of SHUT.
Display starts at 10th falling edge of VSYNC after the falling edge of SHUT.

Interface PIN No. 48 "Display control" have connected Inverters logic gates to the "SHUT" pin.

2.4.2 Power down sequence

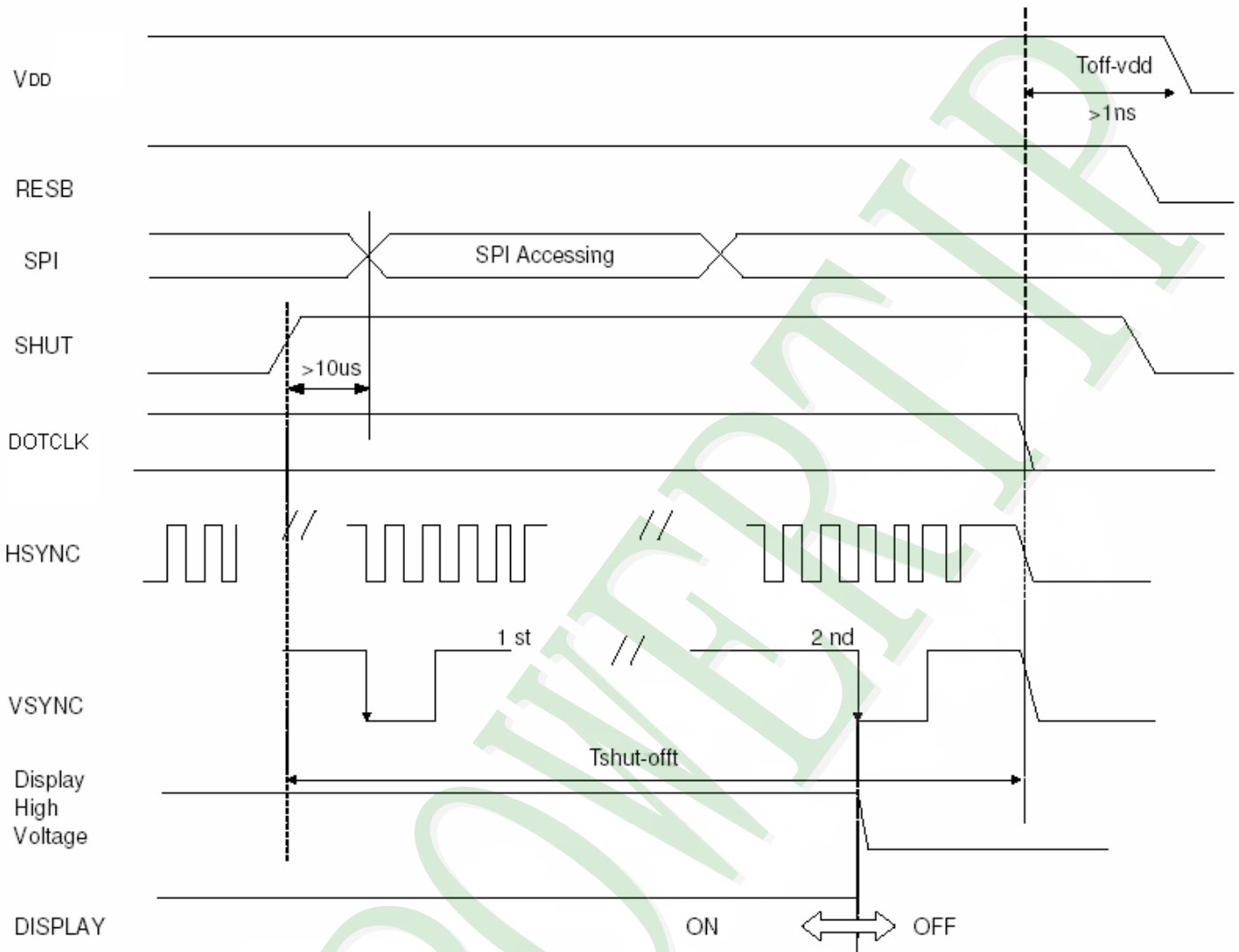

| Characteristics | Symbol | Min | Typ | Max | Uni |
|------------------------------------|-----------|------|-----|-----|-------|
| Rising edge of SHUT to display off | tshut-off | 2 | - | - | frame |
| - 1 line: 408 clk | | 33.4 | - | - | ms |
| - 1 frame: 262 line | | | | | |
| - DOTCLK = 6.5MHz | | | | | |
| Input-signal-off to VDD off | toff-vdd | 1 | - | - | us |

Note: DOTCLK must be maintained at least 2 frames after the rising edge of SHUT.

Display become off at the 2nd falling edge of VSYNC after the falling edge of SHUT.

If RESET signal is necessary for power down, provide it after the 2-frames-cycle of the SHUT period.

2.4.3 Power Timing Characteristics of Backlight

POWER ON

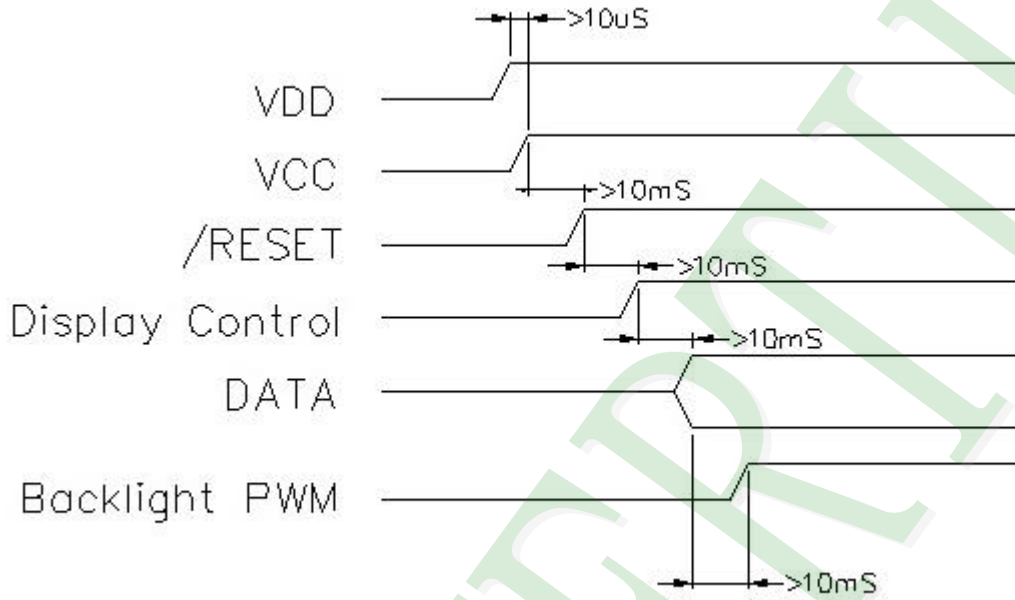

POWER OFF

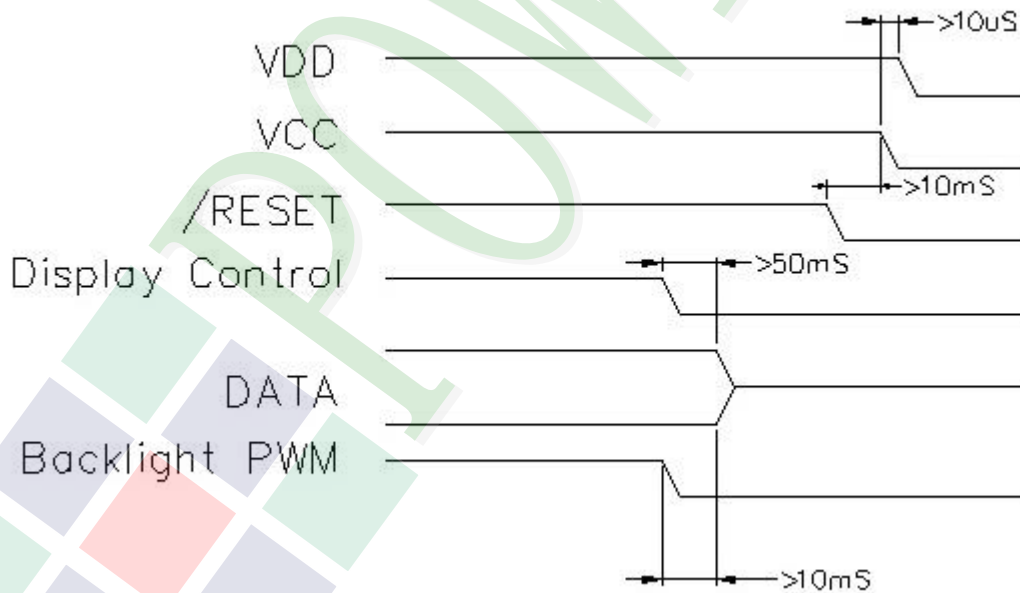

3. QUALITY ASSURANCE SYSTEM

3.1 Quality Assurance Flow Chart

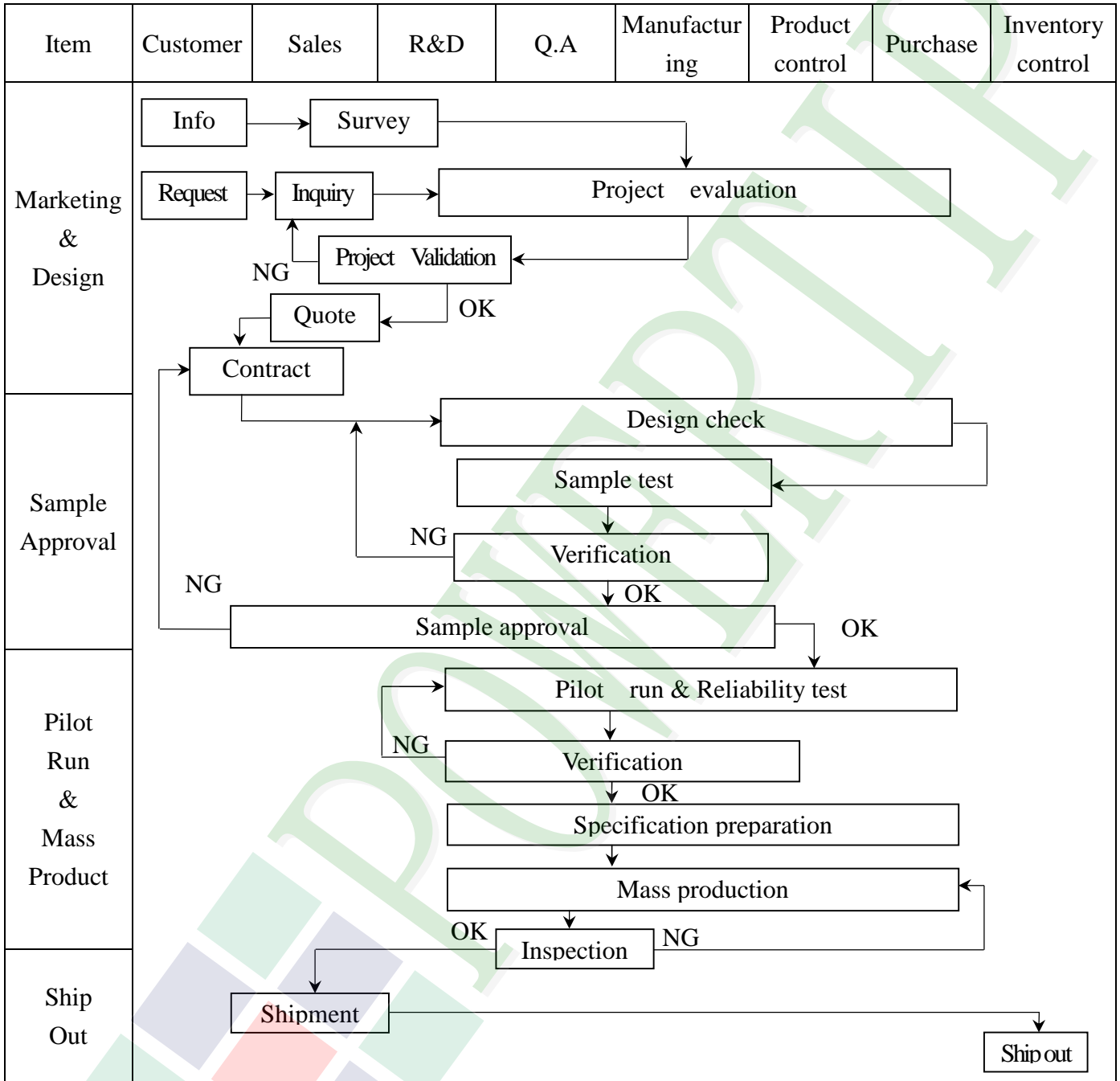

| Item | Customer | Sales | R&D | Q.A | Manufacturing | Product control | Purchase | Inventory control |
|---------------|--|-------|-----|-----|---|-----------------|----------|-------------------|
| Sales Service | <pre> graph TD Info[Info] --> Claim[Claim] Claim --> Failure[Failure analysis] Failure --> Corrective[Corrective action] Corrective --> Tracking[Tracking] Claim --> Report[Analysis report] </pre> | | | | | | | |
| Q.A Activity | 1. ISO 9001 Maintenance Activities 3. Equipment calibration 5. Standardization Management | | | | 2. Process improvement proposal 4. Education And Training Activities | | | |

3.2 Inspection Specification

- ◆Scope : The document shall be applied to TFT-LCD Module for 3.5" ~10" (Ver.B01).
- ◆Inspection Standard : MIL-STD-105E Table Normal Inspection Single Sampling Level II.
- ◆Equipment : Gauge 、 MIL-STD 、 Powertip Tester 、 Sample
- ◆Defect Level : Major Defect AQL : 0.4 ; Minor Defect AQL : 1.5
- ◆OUT Going Defect Level : Sampling.
- ◆Standard of the product appearance test :

a. Manner of appearance test :

- (1). The test best be under 20W×2 fluorescent light , and distance of view must be at 30 cm.
- (2). The test direction is base on about around 45° of vertical line.

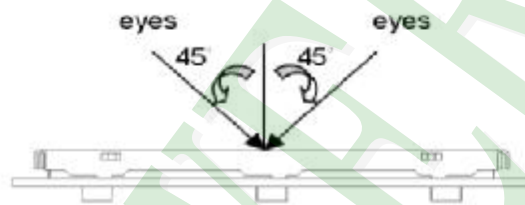

(3). Definition of area.

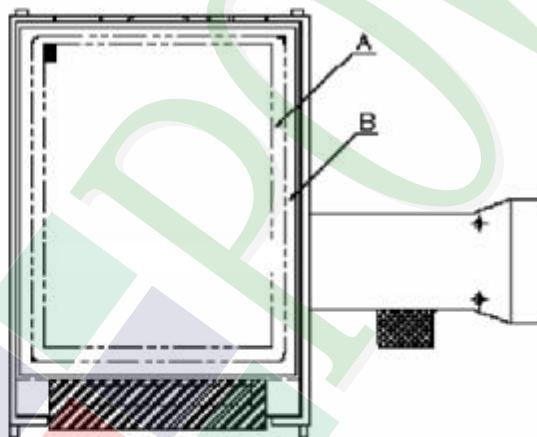

A area : viewing area

B area : Outside of viewing area

(4). Standard of inspection : (Unit : mm)

◆ Specification For TFT-LCD Module 3.5" ~ 10" :

(Ver.B01)

| NO | Item | Criterion | Level | | | | | | | | | | |
|---|---|---|-------------------|-------------------|------------|----------|----------|----------|-----------|----------|-------|----------|-------|
| 01 | Product condition | 1. 1 The part number is inconsistent with work order of production. | Major | | | | | | | | | | |
| | | 1. 2 Mixed product types. | Major | | | | | | | | | | |
| | | 1. 3 Assembled in inverse direction. | Major | | | | | | | | | | |
| 02 | Quantity | 2. 1 The quantity is inconsistent with work order of production. | Major | | | | | | | | | | |
| 03 | Outline dimension | 3. 1 Product dimension and structure must conform to structure diagram. | Major | | | | | | | | | | |
| | | 4. 1 Missing line character and icon. | Major | | | | | | | | | | |
| 04 | Electrical Testing | 4. 2 No function or no display. | Major | | | | | | | | | | |
| | | 4. 3 Display malfunction. | Major | | | | | | | | | | |
| | | 4. 4 LCD viewing angle defect. | Major | | | | | | | | | | |
| | | 4. 5 Current consumption exceeds product specifications. | Major | | | | | | | | | | |
| 05 | Dot defect (Bright dot , Dark dot) On -display | <table border="1"> <thead> <tr> <th>Item</th> <th>Acceptance (Q'ty)</th> </tr> </thead> <tbody> <tr> <td>Bright Dot</td> <td>≤ 4</td> </tr> <tr> <td>Dark Dot</td> <td>≤ 5</td> </tr> <tr> <td>Joint Dot</td> <td>≤ 3</td> </tr> <tr> <td>Total</td> <td>≤ 7</td> </tr> </tbody> </table> | Item | Acceptance (Q'ty) | Bright Dot | ≤ 4 | Dark Dot | ≤ 5 | Joint Dot | ≤ 3 | Total | ≤ 7 | Minor |
| | | Item | Acceptance (Q'ty) | | | | | | | | | | |
| | | Bright Dot | ≤ 4 | | | | | | | | | | |
| | | Dark Dot | ≤ 5 | | | | | | | | | | |
| | | Joint Dot | ≤ 3 | | | | | | | | | | |
| Total | ≤ 7 | | | | | | | | | | | | |
| 5. 1 Inspection pattern : full white , full black , Red , Green and blue screens. | | | | | | | | | | | | | |
| 5. 2 It is defined as dot defect if defect area $> 1/2$ dot. | | | | | | | | | | | | | |
| 5. 3 The distance between two dot defect ≥ 5 mm. | | | | | | | | | | | | | |
| | | | | | | | | | | | | | |

◆ Specification For TFT-LCD Module 3.5" ~10" :

(Ver.B01)

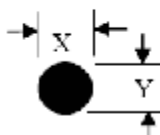
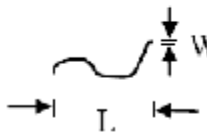
| NO | Item | Criterion | Level | | | | | | | | | | | | | | | | | | | | | | |
|---|---|---|--------------------------------|-------------------|--------|--------|--------|------------------|--------|--|-------------------------|----------------------|--------|-------------------------|--------------|----------------------|---|--------|--------------|---------------|--|--------------|---|--|--|
| 06 | Black or white dot、scratch、contamination Round type  $\Phi = (x + y) / 2$ Line type  | 6.1 Round type (Non-display or display) : <table border="1"> <thead> <tr> <th rowspan="2">Dimension (diameter : Φ)</th> <th colspan="2">Acceptance (Q'ty)</th> </tr> <tr> <th>A area</th> <th>B area</th> </tr> </thead> <tbody> <tr> <td>$\Phi \leq 0.25$</td> <td colspan="2">Ignore</td> </tr> <tr> <td>$0.25 < \Phi \leq 0.50$</td> <td>5</td> <td rowspan="2">Ignore</td> </tr> <tr> <td>$\Phi > 0.50$</td> <td>0</td> </tr> <tr> <td>Total</td> <td colspan="2">5</td> </tr> </tbody> </table> | Dimension (diameter : Φ) | Acceptance (Q'ty) | | A area | B area | $\Phi \leq 0.25$ | Ignore | | $0.25 < \Phi \leq 0.50$ | 5 | Ignore | $\Phi > 0.50$ | 0 | Total | 5 | | Minor | | | | | | |
| | | Dimension (diameter : Φ) | | Acceptance (Q'ty) | | | | | | | | | | | | | | | | | | | | | |
| A area | B area | | | | | | | | | | | | | | | | | | | | | | | | |
| $\Phi \leq 0.25$ | Ignore | | | | | | | | | | | | | | | | | | | | | | | | |
| $0.25 < \Phi \leq 0.50$ | 5 | Ignore | | | | | | | | | | | | | | | | | | | | | | | |
| $\Phi > 0.50$ | 0 | | | | | | | | | | | | | | | | | | | | | | | | |
| Total | 5 | | | | | | | | | | | | | | | | | | | | | | | | |
| 6.2 Line type(Non-display or display) : <table border="1"> <thead> <tr> <th rowspan="2">Length (L)</th> <th rowspan="2">Width (W)</th> <th colspan="2">Acceptance (Q'ty)</th> </tr> <tr> <th>A area</th> <th>B area</th> </tr> </thead> <tbody> <tr> <td>---</td> <td>$W \leq 0.03$</td> <td colspan="2">Ignore</td> </tr> <tr> <td>$L \leq 10.0$</td> <td>$0.03 < W \leq 0.05$</td> <td>4</td> <td rowspan="2">Ignore</td> </tr> <tr> <td>$L \leq 5.0$</td> <td>$0.05 < W \leq 0.10$</td> <td>2</td> </tr> <tr> <td>---</td> <td>$W > 0.10$</td> <td colspan="2">As round type</td> </tr> <tr> <td>Total</td> <td colspan="3">5</td> </tr> </tbody> </table> | Length (L) | Width (W) | Acceptance (Q'ty) | | A area | B area | --- | $W \leq 0.03$ | Ignore | | $L \leq 10.0$ | $0.03 < W \leq 0.05$ | 4 | Ignore | $L \leq 5.0$ | $0.05 < W \leq 0.10$ | 2 | --- | $W > 0.10$ | As round type | | Total | 5 | | |
| Length (L) | | | Width (W) | Acceptance (Q'ty) | | | | | | | | | | | | | | | | | | | | | |
| | A area | B area | | | | | | | | | | | | | | | | | | | | | | | |
| --- | $W \leq 0.03$ | Ignore | | | | | | | | | | | | | | | | | | | | | | | |
| $L \leq 10.0$ | $0.03 < W \leq 0.05$ | 4 | Ignore | | | | | | | | | | | | | | | | | | | | | | |
| $L \leq 5.0$ | $0.05 < W \leq 0.10$ | 2 | | | | | | | | | | | | | | | | | | | | | | | |
| --- | $W > 0.10$ | As round type | | | | | | | | | | | | | | | | | | | | | | | |
| Total | 5 | | | | | | | | | | | | | | | | | | | | | | | | |
| 07 | Polarizer Bubble | <table border="1"> <thead> <tr> <th rowspan="2">Dimension (diameter : Φ)</th> <th colspan="2">Acceptance (Q'ty)</th> </tr> <tr> <th>A area</th> <th>B area</th> </tr> </thead> <tbody> <tr> <td>$\Phi \leq 0.25$</td> <td colspan="2">Ignore</td> </tr> <tr> <td>$0.25 < \Phi \leq 0.50$</td> <td>4</td> <td rowspan="2">Ignore</td> </tr> <tr> <td>$0.50 < \Phi \leq 0.80$</td> <td>1</td> </tr> <tr> <td>$\Phi > 0.80$</td> <td>0</td> <td rowspan="2">Ignore</td> </tr> <tr> <td>Total</td> <td colspan="2">5</td> </tr> </tbody> </table> | Dimension (diameter : Φ) | Acceptance (Q'ty) | | A area | B area | $\Phi \leq 0.25$ | Ignore | | $0.25 < \Phi \leq 0.50$ | 4 | Ignore | $0.50 < \Phi \leq 0.80$ | 1 | $\Phi > 0.80$ | 0 | Ignore | Total | 5 | | Minor | | | |
| Dimension (diameter : Φ) | Acceptance (Q'ty) | | | | | | | | | | | | | | | | | | | | | | | | |
| | A area | B area | | | | | | | | | | | | | | | | | | | | | | | |
| $\Phi \leq 0.25$ | Ignore | | | | | | | | | | | | | | | | | | | | | | | | |
| $0.25 < \Phi \leq 0.50$ | 4 | Ignore | | | | | | | | | | | | | | | | | | | | | | | |
| $0.50 < \Phi \leq 0.80$ | 1 | | | | | | | | | | | | | | | | | | | | | | | | |
| $\Phi > 0.80$ | 0 | Ignore | | | | | | | | | | | | | | | | | | | | | | | |
| Total | 5 | | | | | | | | | | | | | | | | | | | | | | | | |

◆Specification For TFT-LCD Module 3.5" ~10" :

(Ver.B01)

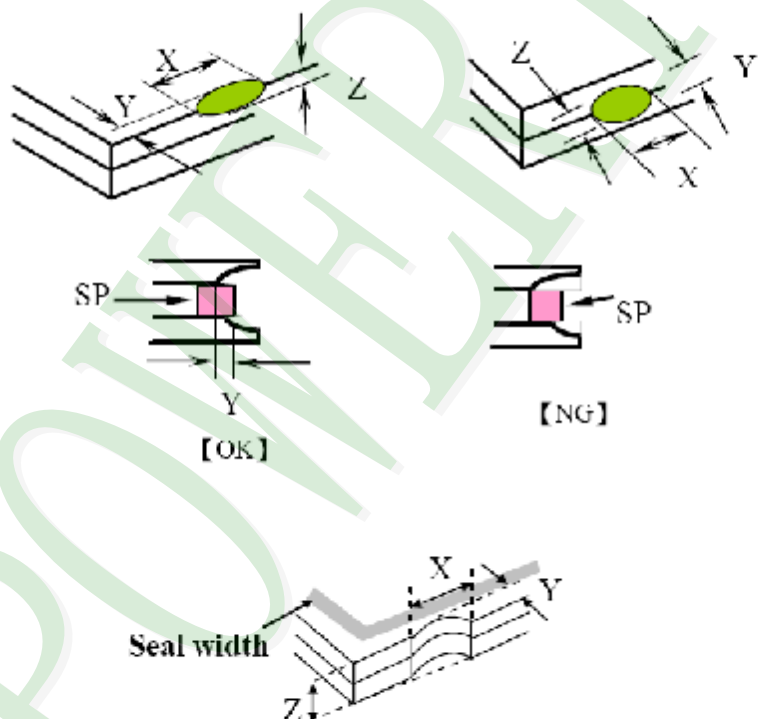
| NO | Item | Criterion | Level | | | | | | |
|----------|--|--|-------|---|---|---|----------|--------------------------------|--------------|
| 08 | The crack of glass | <p>Symbols :</p> <p>X : The length of crack Z : The thickness of crack t : The thickness of glass</p> <p>Y : The width of crack. W : terminal length a : LCD side length</p> | Minor | | | | | | |
| | | <p>8.1 General glass chip :</p> <p>8.1.1 Chip on panel surface and crack between panels:</p>  <table border="1" data-bbox="542 1568 1340 1859"> <thead> <tr> <th>X</th> <th>Y</th> <th>Z</th> </tr> </thead> <tbody> <tr> <td>$\leq a$</td> <td>Crack can't enter viewing area</td> <td>$\leq 1/2 t$</td> </tr> <tr> <td>$\leq a$</td> <td>Crack can't exceed the half of SP width.</td> <td>$1/2 t < Z \leq 2 t$</td> </tr> </tbody> </table> | | X | Y | Z | $\leq a$ | Crack can't enter viewing area | $\leq 1/2 t$ |
| X | Y | Z | | | | | | | |
| $\leq a$ | Crack can't enter viewing area | $\leq 1/2 t$ | | | | | | | |
| $\leq a$ | Crack can't exceed the half of SP width. | $1/2 t < Z \leq 2 t$ | | | | | | | |

◆ Specification For TFT-LCD Module 3.5" ~10" :

(Ver.B01)

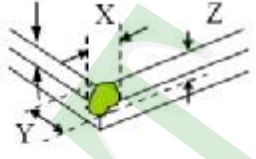
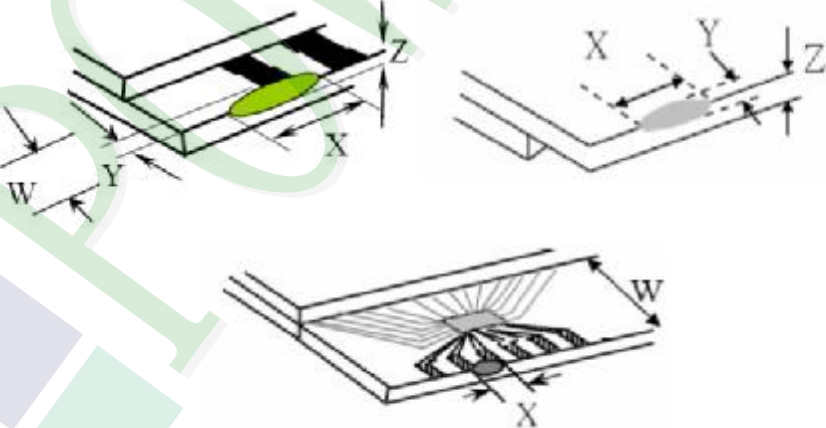
| NO | Item | Criterion | Level | | | | | | | | | | |
|---|--|---|--------------|---|-------|--------------|--------------------------------|----------------|--------------|--|----------------------|--------------|-------|
| 08 | The crack of glass | <p>Symbols :</p> <p>X : The length of crack Z : The thickness of crack t : The thickness of glass</p> <p>Y : The width of crack. W : terminal length a : LCD side length</p> <hr/> <p>8.1.2 Corner crack :</p>  <table border="1" data-bbox="523 772 1332 1064"> <thead> <tr> <th>X</th> <th>Y</th> <th>Z</th> </tr> </thead> <tbody> <tr> <td>$\leq 1/5 a$</td> <td>Crack can't enter viewing area</td> <td>$Z \leq 1/2 t$</td> </tr> <tr> <td>$\leq 1/5 a$</td> <td>Crack can't exceed the half of SP width.</td> <td>$1/2 t < Z \leq 2 t$</td> </tr> </tbody> </table> | X | Y | Z | $\leq 1/5 a$ | Crack can't enter viewing area | $Z \leq 1/2 t$ | $\leq 1/5 a$ | Crack can't exceed the half of SP width. | $1/2 t < Z \leq 2 t$ | | |
| | | X | Y | Z | | | | | | | | | |
| $\leq 1/5 a$ | Crack can't enter viewing area | $Z \leq 1/2 t$ | | | | | | | | | | | |
| $\leq 1/5 a$ | Crack can't exceed the half of SP width. | $1/2 t < Z \leq 2 t$ | | | | | | | | | | | |
| <p>8.2 Protrusion over terminal :</p> <p>8.2.1 Chip on electrode pad :</p>  <table border="1" data-bbox="561 1691 1343 1863"> <thead> <tr> <th></th> <th>X</th> <th>Y</th> <th>Z</th> </tr> </thead> <tbody> <tr> <td>Front</td> <td>$\leq a$</td> <td>$\leq 1/2 W$</td> <td>$\leq t$</td> </tr> <tr> <td>Back</td> <td>$\leq a$</td> <td>$\leq W$</td> <td>$\leq 1/2 t$</td> </tr> </tbody> </table> | | X | Y | Z | Front | $\leq a$ | $\leq 1/2 W$ | $\leq t$ | Back | $\leq a$ | $\leq W$ | $\leq 1/2 t$ | Minor |
| | X | Y | Z | | | | | | | | | | |
| Front | $\leq a$ | $\leq 1/2 W$ | $\leq t$ | | | | | | | | | | |
| Back | $\leq a$ | $\leq W$ | $\leq 1/2 t$ | | | | | | | | | | |

◆ Specification For TFT-LCD Module 3.5" -10" :

(Ver.B01)

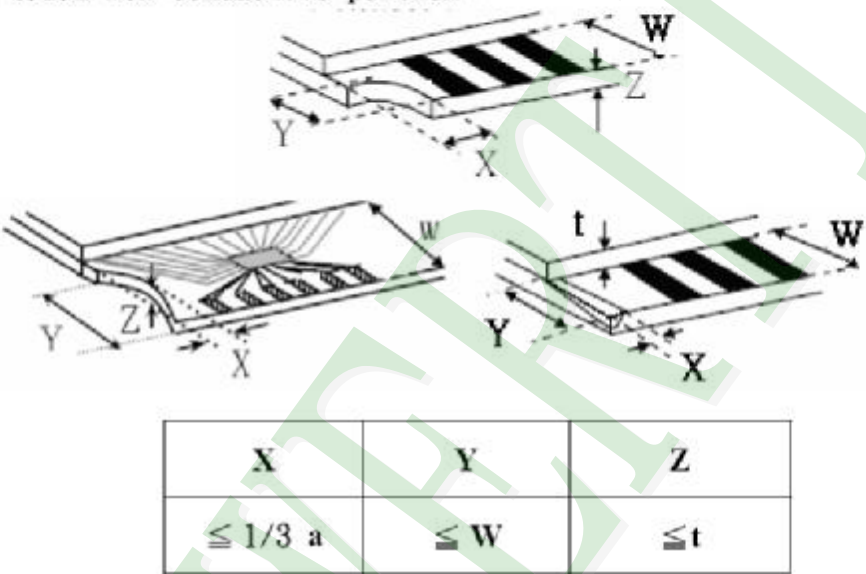
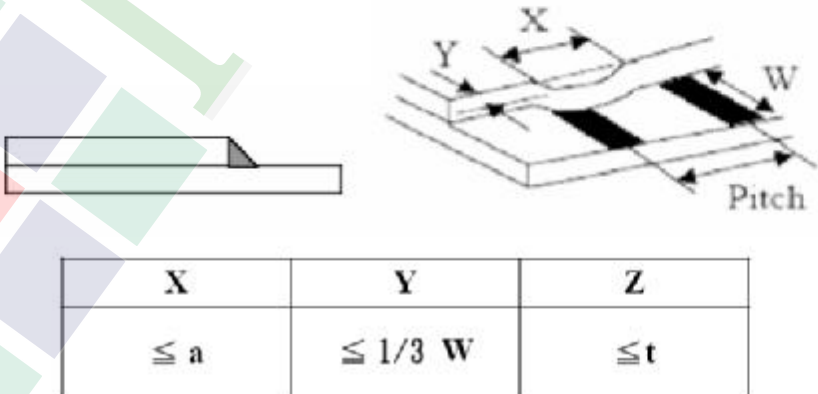
| NO | Item | Criterion | Level |
|----|--------------------|--|-------|
| 08 | The crack of glass | <p>Symbols :</p> <p>X : The length of crack Y : The width of crack. Z : The thickness of crack W : terminal length t : The thickness of glass a : LCD side length</p> | Minor |
| | | <p>8.2.2 Non-conductive portion :</p>  <p>⊙ If the chipped area touches the ITO terminal, over 2/3 of the ITO must remain and be inspected according to electrode terminal specifications.</p> <p>8.2.3 Glass remain :</p>  | |

◆Specification For TFT-LCD Module 3.5" ~10" :

(Ver.B01)

| NO | Item | Criterion | Level |
|----|--------------------|---|-------|
| 09 | Backlight elements | 9. 1 Backlight can't work normally. | Major |
| | | 9. 2 Backlight doesn't light or color is wrong. | Major |
| | | 9. 3 Illumination source flickers when lit. | Major |
| 10 | General appearance | 10. 1 Pin type 、 quantity 、 dimension must match type in structure diagram. | Major |
| | | 10. 2 No short circuits in components on PCB or FPC . | Major |
| | | 10. 3 Parts on PCB or FPC must be the same as on the production characteristic chart .There should be no wrong parts , missing parts or excess parts. | Major |
| | | 10. 4 Product packaging must the same as specified on packaging specification sheet. | Minor |
| | | 10. 5 The folding and pceled off in polarizer are not acceptable. | Minor |
| | | 10. 6 The PCB or FPC between B/L assembled distance(PCB or FPC) is ≤ 1.5 mm. | Minor |

5. PRECAUTION RELATING PRODUCT HANDLING

5.1 SAFETY

- 5.1.1 If the LCD panel breaks , be careful not to get the liquid crystal to touch your skin.
- 5.1.2 If the liquid crystal touches your skin or clothes , please wash it off immediately by using soap and water.

5.2 HANDLING

- 5.2.1 Avoid any strong mechanical shock which can break the glass.
- 5.2.2 Avoid static electricity which can damage the CMOS LSI—When working with the module , be sure to ground your body and any electrical equipment you may be using.
- 5.2.3 Do not remove the panel or frame from the module.
- 5.2.4 The polarizing plate of the display is very fragile. So , please handle it very carefully, do not touch , push or rub the exposed polarizing with anything harder than an HB pencil lead (glass , tweezers , etc.)
- 5.2.5 Do not wipe the polarizing plate with a dry cloth , as it may easily scratch the surface of plate.
- 5.2.6 Do not touch the display area with bare hands , this will stain the display area.
- 5.2.7 Do not use ketonics solvent & aromatic solvent. Use with a soft cloth soaked with a cleaning naphtha solvent.
- 5.2.8 To control temperature and time of soldering is $320 \pm 10^{\circ}\text{C}$ and 3-5 sec.
- 5.2.9 To avoid liquid (include organic solvent) stained on LCM

5.3 STORAGE

- 5.3.1 Store the panel or module in a dark place where the temperature is $25^{\circ}\text{C} \pm 5^{\circ}\text{C}$ and the humidity is below 65% RH.
- 5.3.2 Do not place the module near organics solvents or corrosive gases.
- 5.3.3 Do not crush , shake , or jolt the module.

5.4 TERMS OF WARRANTY

- 5.4.1 Applicable warrant period
The period is within thirteen months since the date of shipping out under normal using and storage conditions.
- 5.4.2 Unaccepted responsibility
This product has been manufactured to your company's specification as a part for use in your company's general electronic products. It is guaranteed to perform according to delivery specifications. For any other use apart from general electronic equipment, we cannot take responsibility if the product is used in nuclear power control equipment, aerospace equipment , fire and security systems or any other applications in which there is a direct risk to human life and where extremely high levels of reliability are required.

| | | | | | |
|---------------|-----------------------|--|---------|-------|---------------|
| Ver.001 | LCM包裝規格書 | | Approve | Check | Contact |
| Documents NO. | JPKG-PH320240T023-IHC | LCM Packaging Specifications (For Tray) | | Ryan | Eddy Terry |

1. 包裝材料規格表 (Packaging Material) : (per carton)

| No. | Item | Model | Dimensions (mm) | 1Pcs Weight | Quantity | Total Weight |
|-----|----------------------|------------------|------------------|-------------|----------|--------------|
| 1 | 成品 (LCM) | PH320240T023-IHC | 84.02X75.3X4.6 | 0.0448 | 252 | 11.2896 |
| 2 | 多層薄膜(1)POF | OTFILM0BA03ABA | 19"X350X0.015 | — | 6 | — |
| 3 | TRAY 盤 (2)Tray | TY00000000408 | 352 X 260 X 12.3 | 0.1 | 48 | 4.8 |
| 4 | 內盒(3)Product Box | BX36627063ABBA | 393 X 274 X 68 | 0.182 | 6 | 1.092 |
| 5 | 保利龍板(4)Polylon board | OTPLB00PL08ABA | 550 X 393 X 20 | 0.0284 | 2 | 0.0568 |
| 6 | 外紙箱(5)Carton | BX57041027CCBA | 570 X 410 X 265 | 1.0 | 1 | 1.0 |
| 7 | | | | | | |
| 8 | | | | | | |
| 9 | | | | | | |

2. 一整箱總重量 (Total LCD Weight in carton) : 18.24 Kg±10%

3. 單箱數量規格表 (Packaging Specifications and Quantity) :

| | | | | | |
|---|----|---------------|---|---|-----|
| (1) LCM quantity per box : no per tray | 6 | x no of tray | 7 | = | 42 |
| (2) Total LCM quantity in carton : quantity per box | 42 | x no of boxes | 6 | = | 252 |

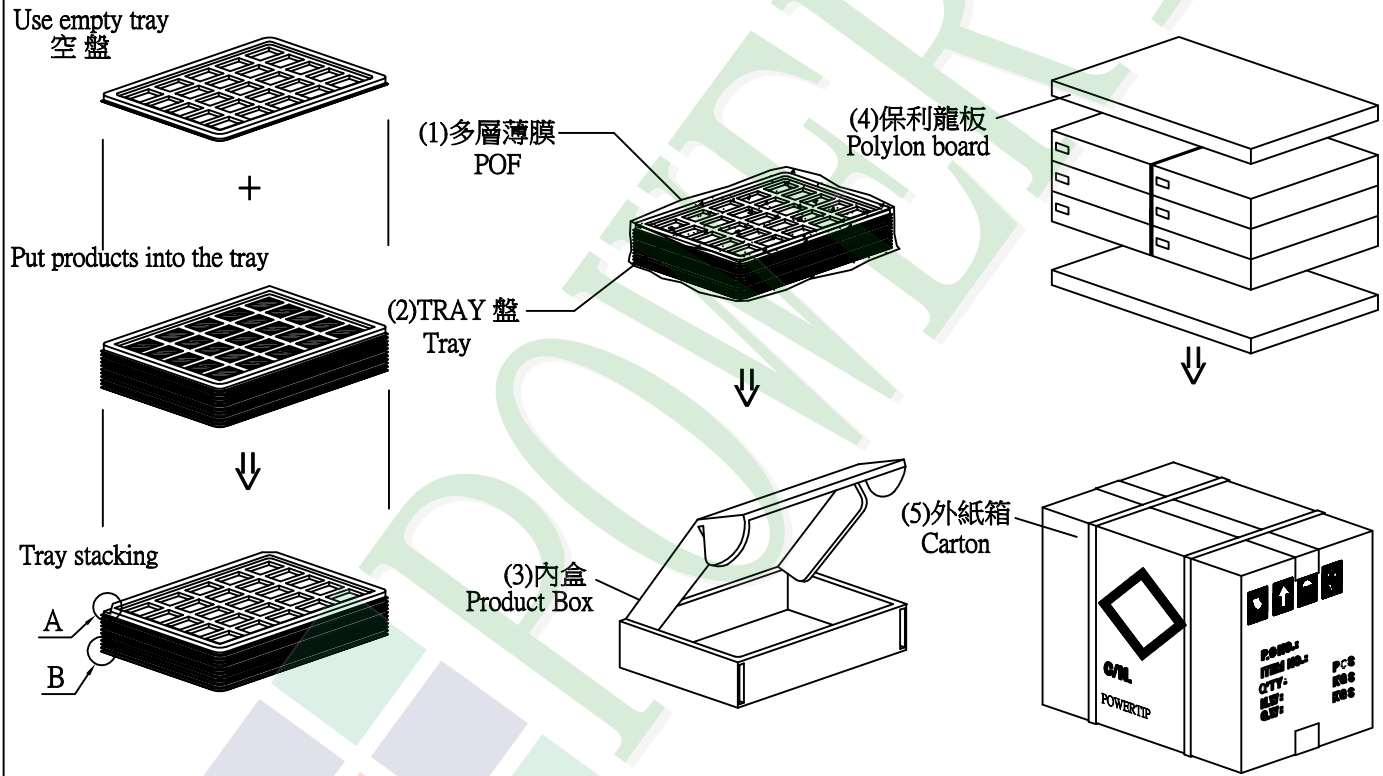

特 記 事 項 (REMARK)

1. Label Specifications :
依廠內標準作業

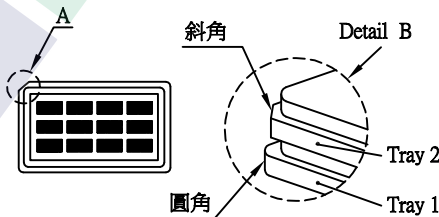

2. TRAY盤相疊時, 需旋轉180度, 請詳見B視圖
Rotate tray 180 degrees and place on top of stack.
Check the tray stack using Fig. B.