

Sample Approval Sheet

Customer Name: TME

Product Name: Deluxe Power Super Flux Pure White LED

Model: OSW5DLZ2C1P

Date: Dec.19, 2016

Optosupply			
Prepared by	Checked by	Approved by	Marketing Dept.
Chaoye Sun	Huazhi	AMY	Daisy Tsai

CUSTOMER CONFIRMATION		
Confirmed by	Checked by	Approved by

Hong Kong Office :

Optosupply Limited

Unit 202, 2/F., Wah Yiu Industrial Centre, 30 - 32, Au Pui Wan Street, Fo Tan, N.T., Hong Kong

Tel : 852-2790 5099 Fax : 852-2342 9833

Factory:

Optosupply Electronics (SZ) Limited

Optosupply Industrial Zone, South Dabu, Longhu Road, Longdong Village, Longgang Town, Shenzhen. P.R.C.

Tel: (86) 755-8484 6601 (106) Fax: (86) 755-8484 6596

E-mail : sales-hk@optosupply.com Website: www.optosupply.com

■Features

- High Luminous Super Flux Output
- 5° Standard Directivity
- Long Lifetime Operation
- Superior Weather-resistance
- UV Resistant Epoxy
- Water Clear Type

■Applications

- Automotive Dashboard Lighting
- Small Area Illuminations
- Back Lighting
- Other Lighting

■Outline Dimension

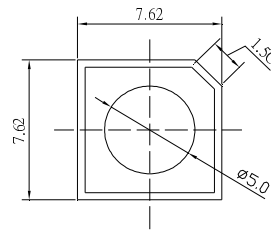

Unit:mm
Tolerance:±0.20mm
unless otherwise noted
1,4 Anode
2,3 Cathode

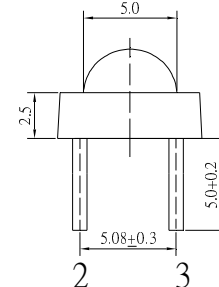
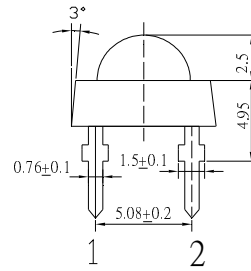

■Absolute Maximum Rating

(Ta=25°C)

Item	Symbol	Value	Unit
DC Forward Current	I _F	40	mA
Pulse Forward Current*	I _{FP}	100	mA
Reverse Voltage	V _R	5	V
Power Dissipation	P _D	152	mW
Operating Temperature	T _{opr}	-30 ~ +85	°C
Storage Temperature	T _{stg}	-40 ~ +100	°C
Lead Soldering Temperature	T _{sol}	260°C/5sec	-

*Pulse width Max.10ms Duty ratio max 1/10

■Directivity

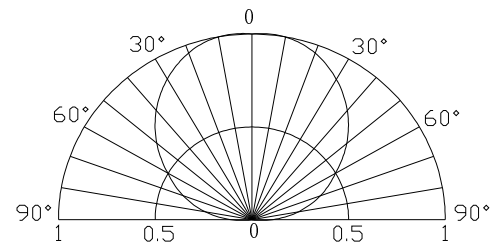

■Electrical -Optical Characteristics

(Ta=25°C)

Item	Symbol	Condition	Min.	Typ.	Max.	Unit
DC Forward Voltage	V _F	I _F =30mA	3.0	3.2	3.8	V
DC Reverse Current	I _R	V _R =5V	-	-	10	μA
Luminous Intensity*	I _v	I _F =30mA	7000	8800	-	mcd
Color Temperature	CCT	I _F =30mA	8000	10000	18000	K
Chromaticity Coordinates*	x	I _F =30mA	-	0.27	-	
	y	I _F =30mA	-	0.28	-	
50% Power Angle	2θ _{1/2}	I _F =30mA	-	120	-	deg

*1 Tolerance of measurements of chromaticity coordinates is ±10%

*2 Tolerance of measurements of luminous intensity is ±15%

*3 Tolerance of measurements of forward voltage is ±0.1V



■ **Color Rank For Pure White LED**

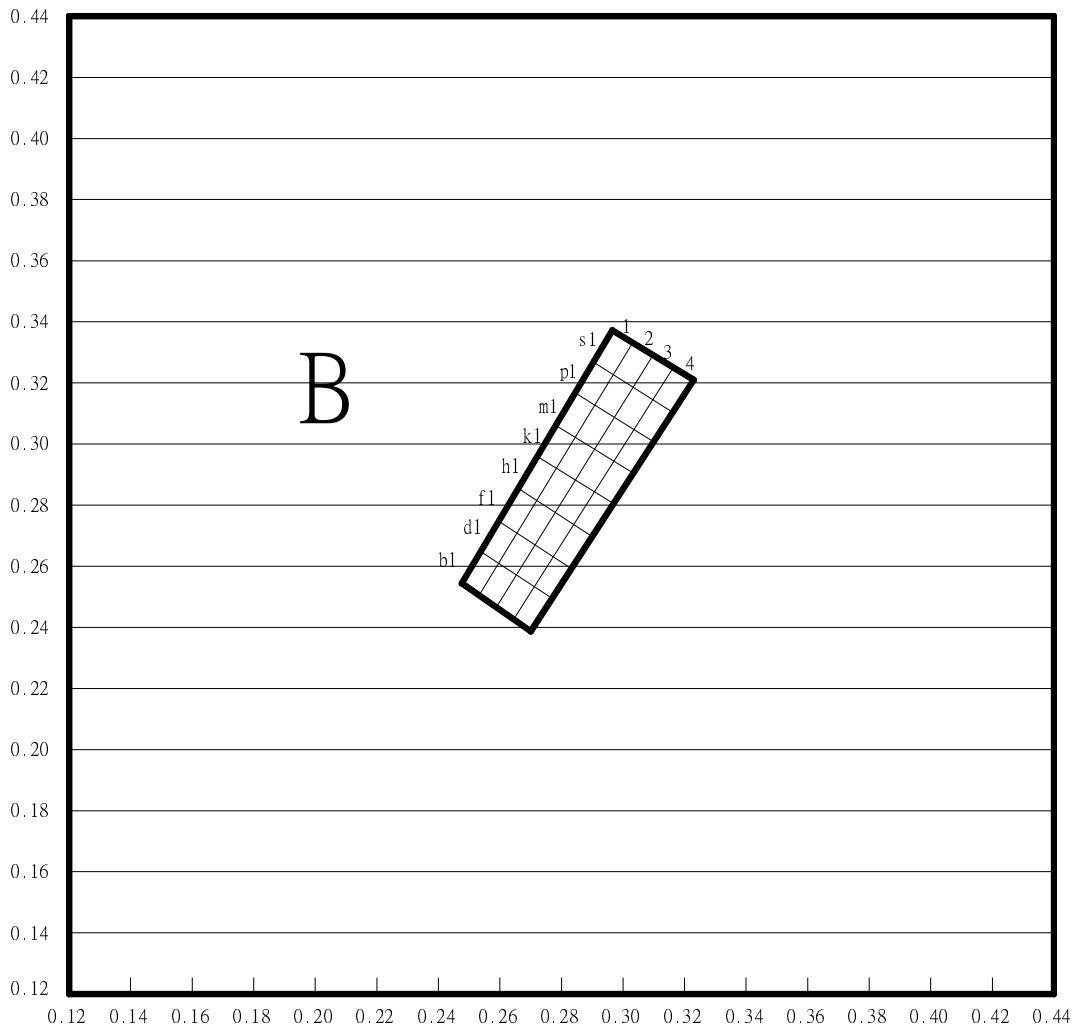

■ **Detail Color Bins Of The Type White LEDs**

Bin	1		2		3		4	
Code	X1	Y1	X2	Y2	X3	Y3	X4	Y4
Bb1	0.247	0.254	0.253	0.264	0.27	0.238	0.276	0.249
Bd1	0.253	0.264	0.26	0.274	0.276	0.249	0.283	0.259
Bf1	0.26	0.274	0.266	0.285	0.283	0.259	0.29	0.269
Bh1	0.266	0.285	0.272	0.295	0.29	0.269	0.296	0.28
Bk1	0.272	0.295	0.278	0.305	0.296	0.28	0.303	0.29
Bm1	0.278	0.305	0.285	0.316	0.303	0.29	0.309	0.3
Bp1	0.285	0.316	0.291	0.326	0.309	0.3	0.316	0.31
Bs1	0.291	0.326	0.297	0.336	0.316	0.31	0.322	0.321

■Ranks Combination

Rank ($I_F=30mA$)	RR	SS	-
Luminous Intensity (mcd)	7000-8400	8400-10000	-

Rank ($I_F=30mA$)	Bh1(1-4)	Bk1(1-4)	Bm1(1-4)	Bp1(1-4)
Color temperature(K)	14000-18000	12000-14000	10000-12000	8000-10000

Rank ($I_F=30mA$)	99	AA	BB	CC	-
DC Forward Voltage(V)	3.0-3.2	3.2-3.4	3.4-3.6	3.6-3.8	-

InGaN LED

TYPICAL ELECTRICAL/OPTICAL CHARACTERISTIC CURVES

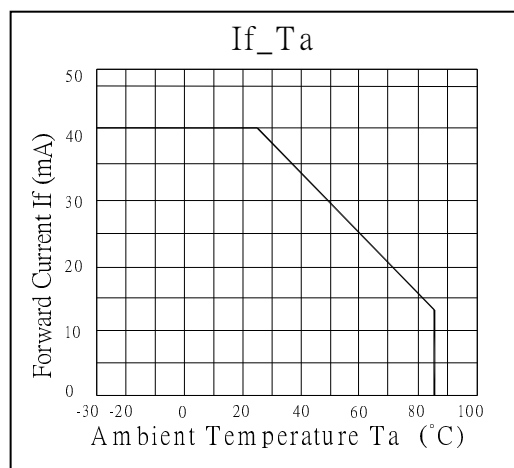
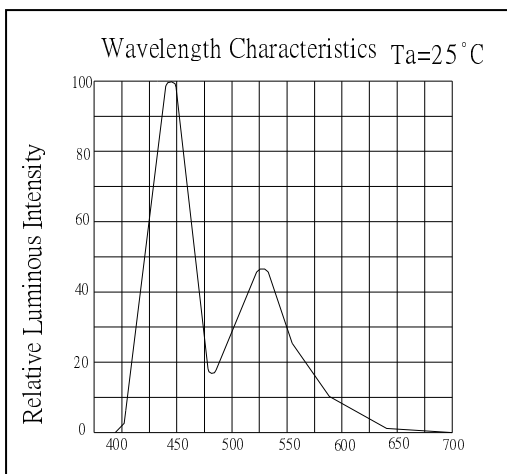
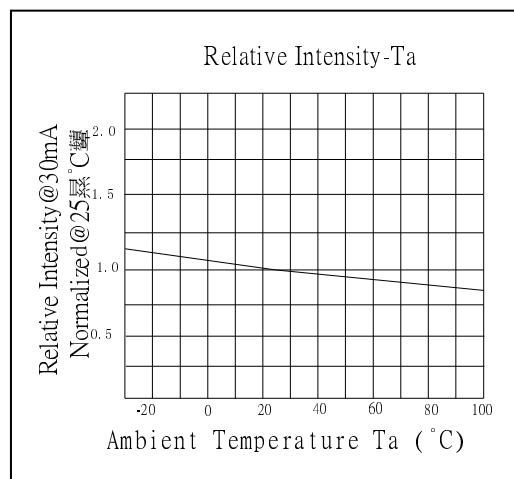
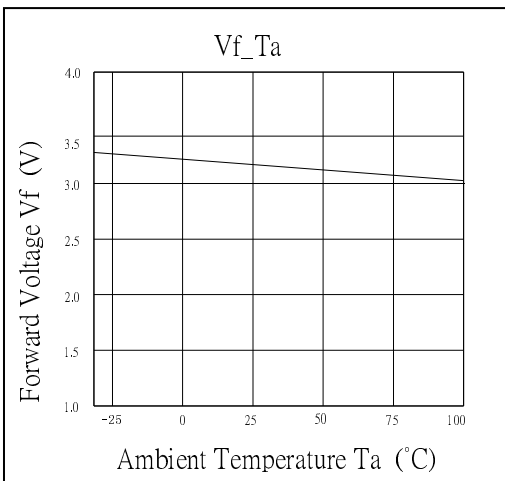
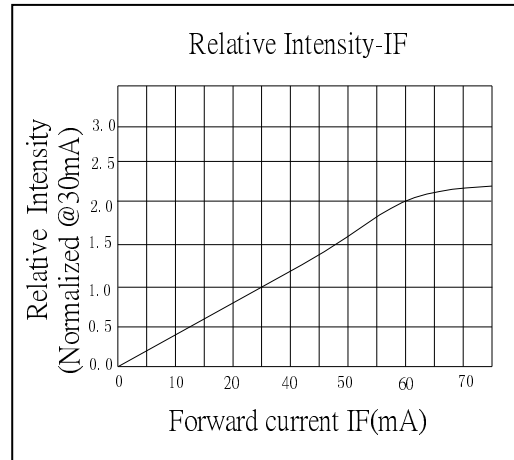
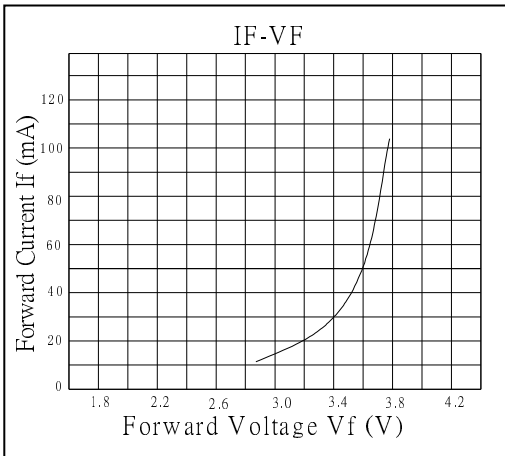

RELIABILITY TEST REPORT

CLASSIFICATION	TEST ITEM	TEST CONDITON
ENDURANCE TEST	ROOM TEMPERATURE OPERATION LIFE	If: 30mA Ta:25±5 °C TEST TIME=1000HRS
	HIGH TEMPERTURE HIGH HUMIDITY STORAGE	R.H:90~95% Ta:65±5°C TEST TIME=240HRS(+2HRS)
	HIGH TEMPERTURE STORAGE	Ta:100°C TEST TIME=500HRS(-24HRS,+48HRS)
	LOW TEMPERTURE STORAGE	Ta:-40°C TEST TIME=500HRS(-24HRS,+48HRS)
	ENVIRONMENTAL TEST	TEMPERTURE CYCLING
	RESISTANCE TO SOLDERING HEAT	Ta:260±5°C TEST TIME=10±1sec
	SOLDERABILITY	Ta:245±5°C TEST TIME=5±1sec

JUDGMENT CRITERIA OF FAILURE FOR THE RELIABILITY

MEASURING ITME	SYMBOL	CONDITIONS	FAILURE CRITERIA
LUMINOUS INTENSITY	IV	IF=30mA	IV<0.5*L.S.L
FORWARD VOLTAGE	VF	IF=30mA	VF>1.2*U.S.L
REVERSE CURRENT	IR	Vr=5V	IR>2*U.S.L
SOLDERABILITY	-	-	LESS THAN 95% SOLDER COVERAGE

U.S.L : Upper Specification Limit

L.S.L : Lower Specification Limit

OPERATION LIFE TEST LUMINANCE RATE CURVE

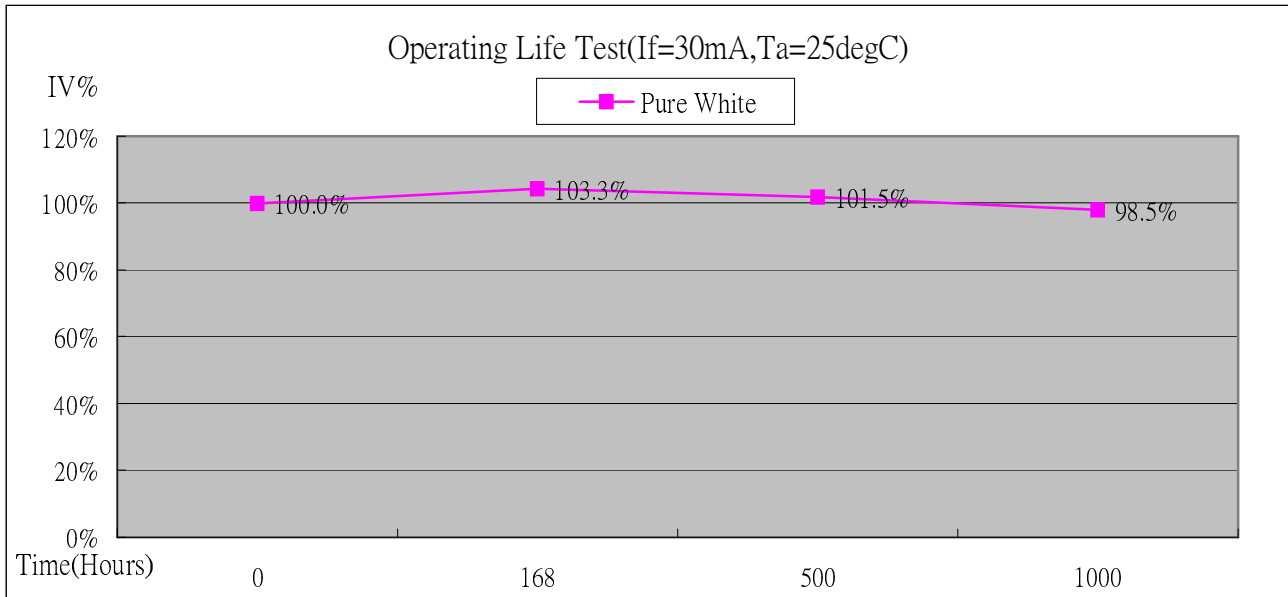

- *Burn-in condition: 30mA
- *Projection of Statistical Average Light Output Degradation Performance for LED Technology Extrapolated from OptoSupply QA Dept. Test Data.
- *According to OptoSupply outgoing Packaged Products Specification
- *MTBF:100,000hrs, 90% Confidence (A Failure is Any LED Which is Open, shorted or fails to Emit Light)
- *The Projected Data is Base on The Feature of LED Itself Under Normal Operation Conditions.
- *Any Improper Circuit Design or External Factors Might Cause a Different Result.

LAMP APPLICATION (PB FREE SOLDERJING)

Apply to LAMP (DIP) SERIES.

Description:

(1) Manual soldering (Solder Iron)

- (1.1) Temperature at tip of the iron: 350°C Max.
- (1.2) It's banned to load any stress on the resin during soldering.
- (1.3) Soldering time: 3sec.Max.(one time only.)
- (1.4) Leave 3mm of minimum distance from the base of the epoxy.

(2) Dip Soldering (Wave Soldering-Solder Bath)

- (2.1) Leave 3mm of minimum distance from the base of the epoxy.
Soldering beyond the base of the tie bar (stand off) is recommended.
- (2.2) When soldering, do not put stress on the LEDs during heating.
- (2.3) Cutting the lead frames at high temperatures may cause LED failure.
- (2.4) Never take next process until the component is cooled down to room temperature after reflow.
- (2.5) After soldering, do not warp the circuit board.
- (2.6) The recommended dip soldering profile is the following.

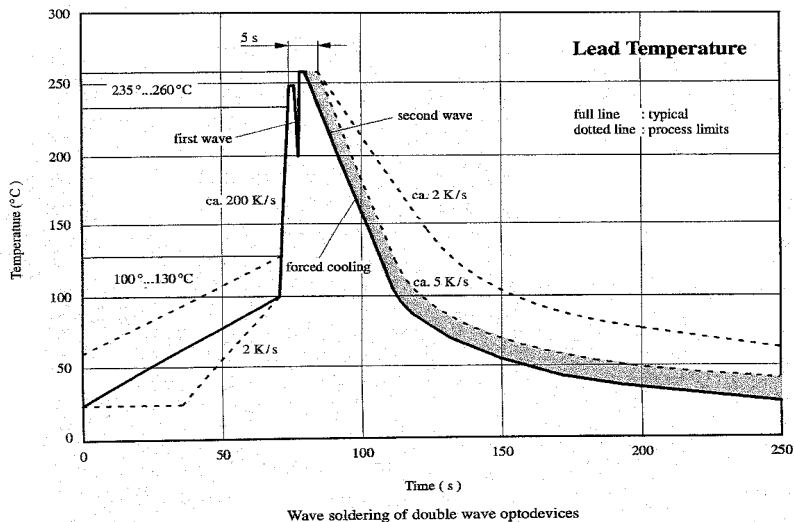

PACKING DIMENSION

500pcs/Bag

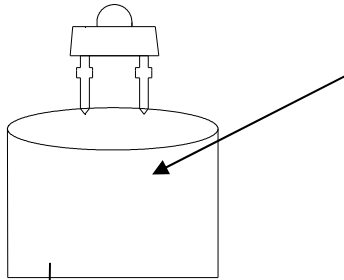

LED LAMPS	
PART NO:	_____
LOT NO:	_____
IV:	_____
VF:	_____
COLOR:	_____
QTY:	_____
QC:	_____

BOX

Dimension (mm)

396*305*324

40Bags/Box

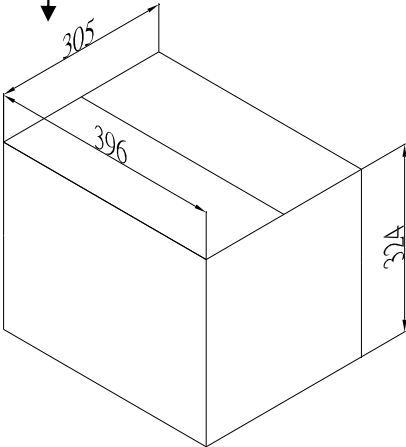

Carton

Dimension (mm)

675*410*320

2Boxes/Carton

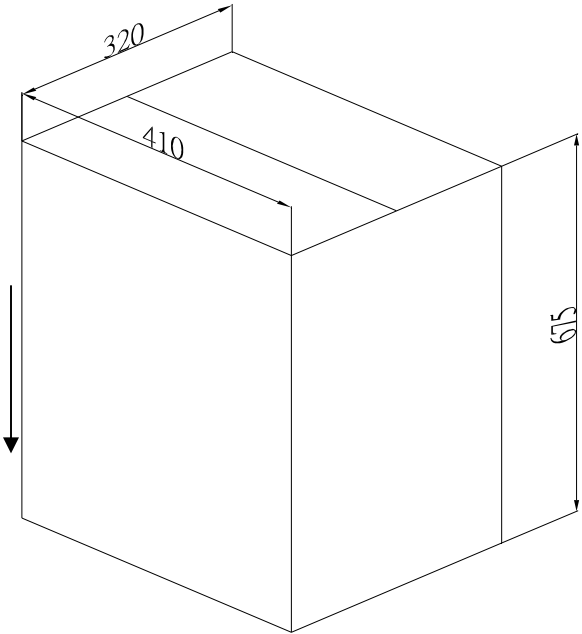

LED LAMPS	
PART NO:	_____
LOT NO:	_____
IV:	_____
VF:	_____
COLOR:	_____
QTY:	_____
QC:	_____