

**■Features**

- High Luminous LEDs
- 5mm Round Standard Directivity
- Long Lifetime Operation
- Superior Weather-resistance
- UV Resistant Epoxy/ Water Clear Type
- AC LED

**■Applications**

- Toys
- Audio
- Games
- Other Lighting

**■Outline Dimension**

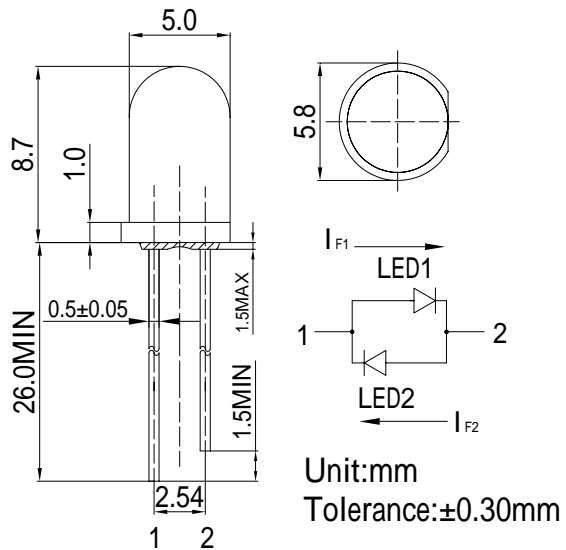

**■Absolute Maximum Rating**

(Ta=25 )

Item	Symbol	Value		Unit
		LED1	LED2	
DC Forward Current	I <sub>F</sub>	30	30	mA
Pulse Forward Current*	I <sub>FP</sub>	100	100	mA
Reverse Voltage	V <sub>R</sub>	5	5	V
Power Dissipation	P <sub>D</sub>	78	78	mW
Operating Temperature	Topr	-30 ~ +85		
Storage Temperature	Tstg	-40 ~ +100		
Lead Soldering Temperature	Tsol	260 /5sec		-

**■Directivity**

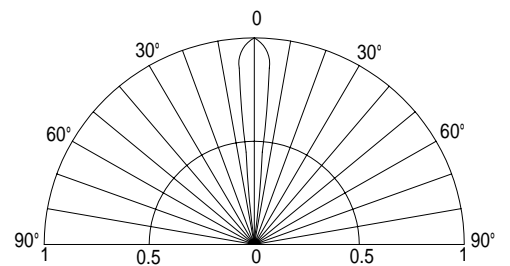

\*Pulse width Max.10ms Duty ratio max 1/10

**■Electrical -Optical Characteristics**

(Ta=25 )

Item	NO.	Symbol	Condition	Min.	Typ.	Max.	Unit
DC Forward Voltage	LED1	V <sub>F1</sub>	I <sub>F1</sub> =20mA	1.8	2.1	2.6	V
	LED2	V <sub>F2</sub>	I <sub>F2</sub> =20mA	1.8	2.1	2.6	V
Domi. Wavelength*	LED1	λ <sub>D1</sub>	I <sub>F1</sub> =20mA	620	625	630	nm
	LED2	λ <sub>D2</sub>	I <sub>F2</sub> =20mA	620	625	630	nm
Luminous Intensity*	LED1	I <sub>v1</sub>	I <sub>F1</sub> =20mA	4200	5800	-	mcd
	LED2	I <sub>v2</sub>	I <sub>F2</sub> =20mA	4200	5800	-	mcd
50% Power Angle	LED1	2θ <sub>1/2</sub>	I <sub>F1</sub> =20mA	-	15	-	deg
	LED2	2θ <sub>1/2</sub>	I <sub>F2</sub> =20mA	-	15	-	deg

\*Tolerance of dominant chromaticity is ±10%

\*2 Tolerance of luminous intensity is ±15%