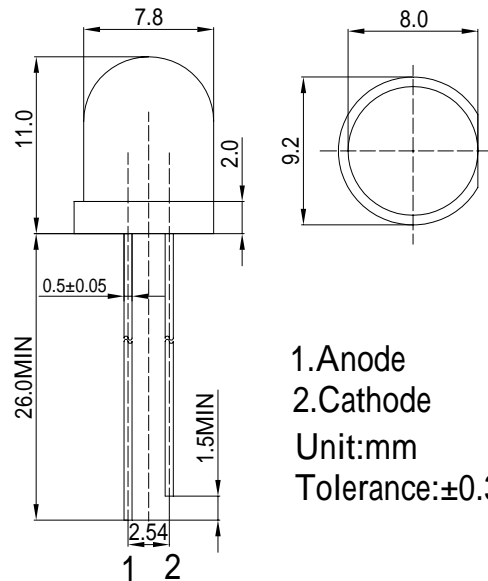

■Features

- High Luminous LEDs
- 8mm Round Standard Directivity
- Superior Weather-resistance
- UV Resistant Epoxy
- Water Clear Type

■Applications

- Traffic signal, Portable light source
- Signage and channel letter
- Decorating and entertainment lighting
- Architectural lighting
- Outdoor/Indoor applications/Other Lighting

■Outline Dimension

1. Anode
2. Cathode
Unit:mm
Tolerance:±0.30mm

■Absolute Maximum Rating

(Ta=25 °C)

Item	Symbol	Value	Unit
DC Forward Current	I_F	50	mA
Pulse Forward Current*	I_{FP}	120	mA
Reverse Voltage	V_R	5	V
Power Dissipation	P_D	130	mW
Operating Temperature	T_{opr}	-40~ +85	
Storage Temperature	T_{stg}	-40 ~ +100	
Lead Soldering Temperature	T_{sol}	260 /5sec	-

*Pulse width Max.10ms , Duty ratio max 1/10

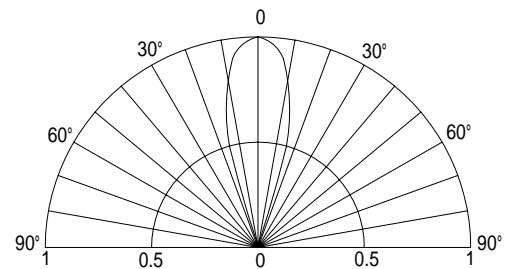
■Directivity

■Electrical -Optical Characteristics

(Ta=25 °C)

Item	Symbol	Condition	Min.	Typ.	Max.	Unit
DC Forward Voltage	V_F	$I_F=20mA$	1.8	2.1	2.6	V
DC Reverse Current	I_R	$V_R=5V$	-	-	10	μA
Domi. Wavelength*	λ_D	$I_F=20mA$	620	625	630	nm
Luminous Intensity*	I_v	$I_F=20mA$	7000	9000	-	mcd
50% Power Angle	$2\theta_{1/2}$	$I_F=20mA$	-	30	-	deg

 *1 Tolerance of dominant wavelength is $\pm 1nm$

 *2 Tolerance of luminous intensity is $\pm 15\%$
Maximum Forward Current
