

■Features

- High Power LEDs
- 5 ϕ Standard Directivity
- Superior Weather-resistance
- UV Resistant Epoxy
- RoHS compliant

■Applications

- Automotive Dashboard Lighting
- Back Lighting
- Traffic Signal Lamp

■Outline Dimension

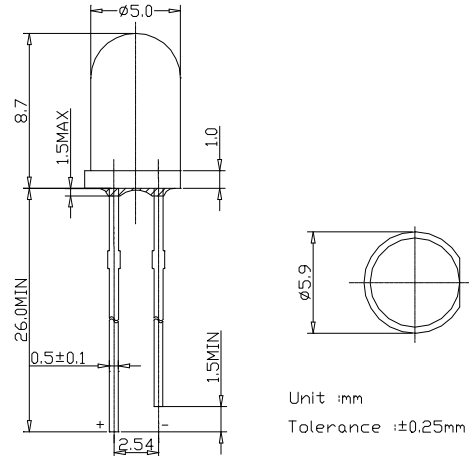

■Absolute Maximum Rating

(Ta=25°C)

Item	Symbol	Value	Unit
DC Forward Current	I _F	30	mA
Pulse Forward Current*	I _{FP}	100	mA
Reverse Voltage	V _R	5	V
Power Dissipation	P _D	120	mW
Operating Temperature	Topr	-30 ~ +80	°C
Storage Temperature	Tstg	-30 ~ +100	°C
Lead Soldering Temperature	Tsol	260°C/3sec	-

■Directivity

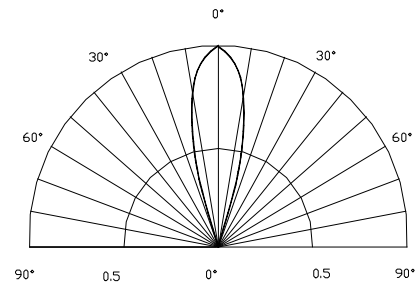

*Pulse width Max.10ms Duty ratio max 1/10

■Electrical -Optical Characteristics

(Ta=25°C)

Item	Symbol	Condition	Min.	Typ.	Max.	Unit
DC Forward Voltage	V _F	I _F =20mA	2.8	3.4	4.0	V
DC Reverse Current	I _R	V _R =5V	-	-	10	μA
Domi. Wavelength	λ _D	I _F =20mA	520	525	530	nm
Luminous Intensity	I _v	I _F =20mA	8400	10000	-	mcd
50% Power Angle	2θ _{1/2}	I _F =20mA	-	30	-	deg