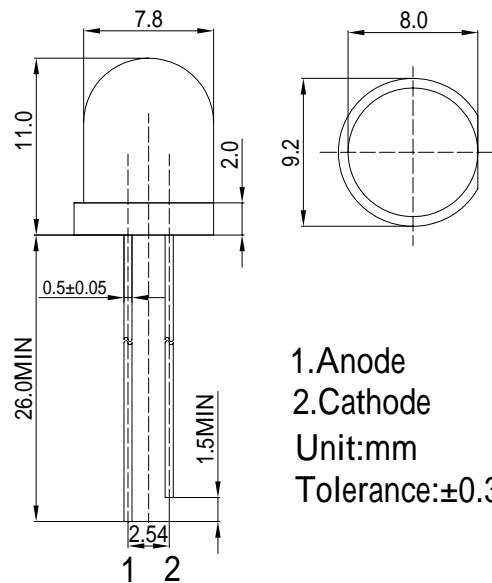

Features

High Luminous LEDs
 8mm Round Standard Directivity
 Superior Weather-resistance
 UV Resistant Epoxy
 Water Clear Type

Applications

Electronic Signs And Signals
 Small Area Illuminations
 Back Lighting
 Other Lighting

Outline Dimension

1. Anode
 2. Cathode
 Unit:mm
 Tolerance:±0.30mm

Absolute Maximum Rating
(Ta=25)

Item	Symbol	Value	Unit
DC Forward Current	I_F	30	mA
Pulse Forward Current*	I_{FP}	100	mA
Reverse Voltage	V_R	5	V
Power Dissipation	P_D	78	mW
Operating Temperature	T_{opr}	-30 ~ +85	
Storage Temperature	T_{stg}	-40 ~ +100	
Lead Soldering Temperature	T_{sol}	260 /5sec	-

*Pulse width Max.10ms Duty ratio max 1/10

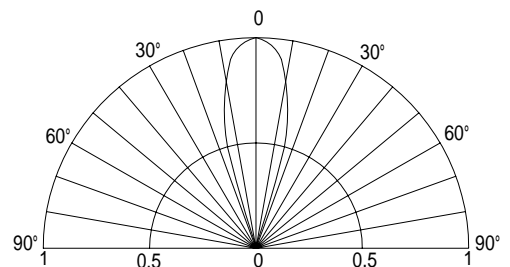
Directivity

Electrical -Optical Characteristics
(Ta=25)

Item	Symbol	Condition	Min.	Typ.	Max.	Unit
DC Forward Voltage	V_F	$I_F=20mA$	1.8	2.1	2.6	V
DC Reverse Current	I_R	$V_R=5V$	-	-	10	μA
Domi. Wavelength*	λ_D	$I_F=20mA$	600	605	610	nm
Luminous Intensity*	I_v	$I_F=20mA$	4000	6000	-	mcd
50% Power Angle	$2\theta_{1/2}$	$I_F=20mA$	-	30	-	deg

*1 Tolerance of dominant wavelength is $\pm 1nm$

*2 Tolerance of luminous intensity is $\pm 15\%$