

■Features

- Green Diffused Type
- 3mm Standard Directivity
- Superior Weather-resistance
- RoHS compliant

■Applications

- Toys
- Games
- Audio
- Christmas Light

■Outline Dimension

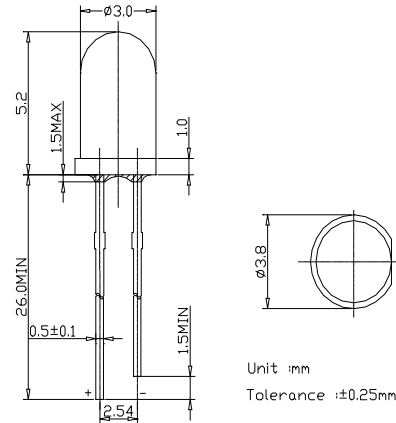

■Absolute Maximum Rating

(Ta=25°C)

Item	Symbol	Value	Unit
DC Forward Current	I_F	50	mA
Pulse Forward Current*	I_{FP}	150	mA
Reverse Voltage	V_R	5	V
Power Dissipation	P_D	200	mW
Operating Temperature	T_{opr}	-30 ~ +85	°C
Storage Temperature	T_{stg}	-30 ~ +100	°C
Lead Soldering Temperature	T_{sol}	260°C/5sec	-

*Pulse width Max.10ms Duty ratio max 1/10

■Directivity

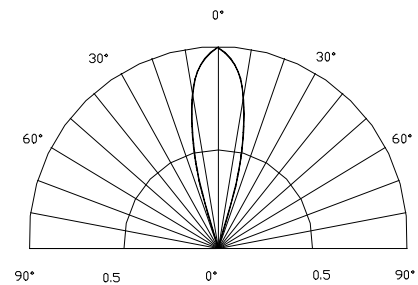

■Electrical -Optical Characteristics

(Ta=25°C)

Item	Symbol	Condition	Min	Typ	Max	Unit
DC Forward Voltage	V_F	$I_F=20mA$	1.8	2.0	2.4	V
DC Reverse Current	I_R	$V_R=5V$	-	-	10	μA
Domi. Wavelength	λ_D	$I_F=20mA$	565	570	575	nm
Luminous Intensity	I_v	$I_F=20mA$	10	15	20	mcd
50% Power Angle	$2\theta_{1/2}$	$I_F=20mA$	-	30	-	deg