

S1

FEMALE SIDES M8  
FACE VIEWS

MALE SIDES M12  
FACE VIEWS

S2

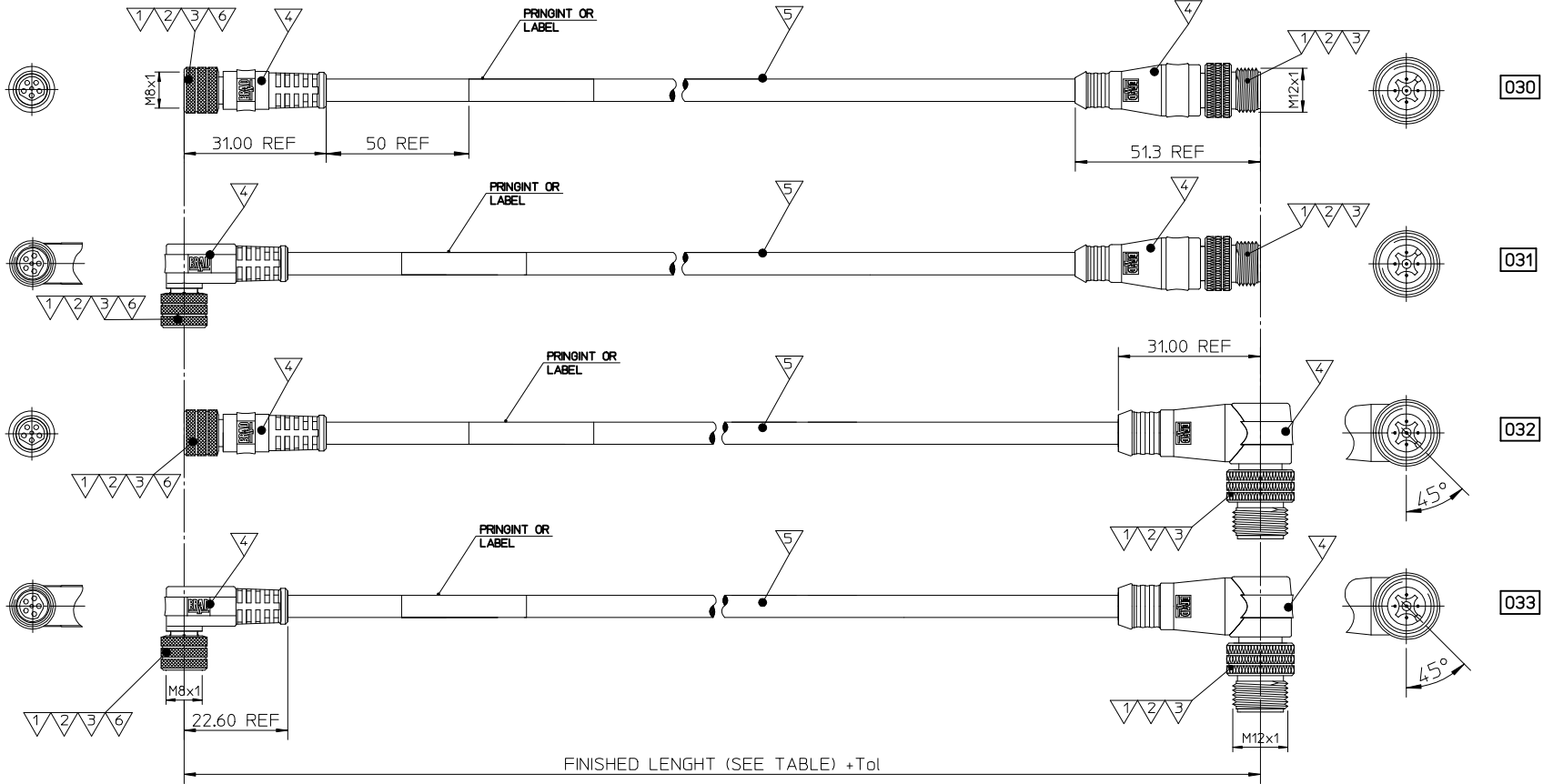

FINISHED LENGHT (SEE TABLE) +Tol

CONNECTOR SPECIFICATION:

VOLTAGE RATING	3-4POL:60V/AC-75V/DC   5P/60V
AMPERAGE RATING	max. 4 AMPS
PROTECTION	IP68
OPERATING TEMPERATURE	-25°C TO 80°C

6	O-RING	VITON	---
5	CABLE	SEE TABLE	---
4	OVERMOULDING	TPU UF NATURAL C98A10	---
4	OVERMOULDING	MASTERBATCH COLORANT	---
3	COUPLING NUT	SEE SPECIAL TYPES	---
2	PIN CONTACT	COPPER ALLOY	GOLD OR NICKEL PLATED
1	INSERT	PUR	BLACK
ITEM	PART	MATERIAL	FINISH

ORIGINAL RELEASE  
EC NO: IPG2013-1417  
DRW:MD/SZEWKA 2013/03/11  
CHKD:JMARSZALEK 2013/03/11  
APPR:MIWASIECZKO 2013/03/12

QUALITY SYMBOLS  
▽=0  
◻=0

GENERAL TOLERANCES (UNLESS SPECIFIED)

	mm	INCH
4 PLACES	± ---	± ---
3 PLACES	± ---	± ---
2 PLACES	± ---	± ---
1 PLACE	± ---	± ---
0 PLACE	± ---	± ---

ANGULAR ±---°  
DRAFT WHERE APPLICABLE  
MUST REMAIN WITHIN DIMENSIONS

DIMENSION STYLE  
MM ONLY

DRAWN BY	DATE
HWALCZAK	2012/11/24
CHECKED BY	DATE
JMARSZALEK	2013/01/14
APPROVED BY	DATE
MIWASIECZKO	2013/01/15

MATERIAL NO.  
SEE CHART

SCALE  
DESIGN UNITS  
METRIC

FIRST ANGLE PROJECTION

TITLE  
CSE M8 M12 XP XC FE MA  
XM DE

**molex**

DOCUMENT NO.  
SD-120087-045

SHEET NO.  
1 OF 3

THIS DRAWING CONTAINS INFORMATION THAT IS PROPRIETARY TO MOLEX INCORPORATED AND SHOULD NOT BE USED WITHOUT WRITTEN PERMISSION

10 9 8 7 6 5 4 3 2 1

SPECIAL TYPES

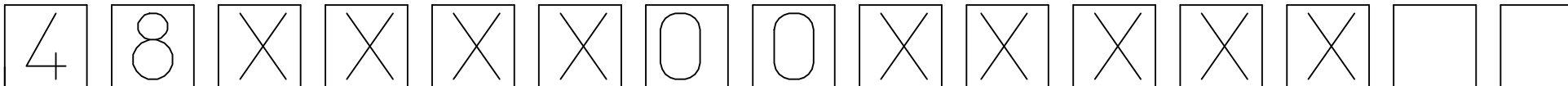

Thread M8x1 Thread M12x1

POLES **1**  
 3- INSERT 3 POLES  
 4- INSERT 4 POLES  
 5- INSERT 5 POLES

HEAD TYPE  
 030 Plugs female M8 and male M12 straight  
 031 Plugs female M8 90° and male M12 straight  
 032 Plugs female M8 straight and male M12 90°  
 033 Plugs female M8 and male M12 90°

CABLE TYPES **5**  
 E02 = 0,25mm², PVC black  
 E18 = 0,2mm², PVC yellow braid DC  
 H08 = 0,25mm², PUR black LSOH  
 H69 = 0,2mm², PUR grey LSOH SCR  
 I02 = 0,25mm², PVC grey CEI  
 P02 = 0,25mm², PUR/PVC black  
 P08 = 0,25mm², PUR yellow HIFLEX  
 P82 = 0,34mm², PUR orange irradiated DC  
 S20 = 0,34mm², PVC yellow SJTO braid  
 S26 = 0,34mm², PVC yellow SJTO braid AC

LENGTH UNIT  
 C-cm  
 M-m  
 K-km  
 F-feet

LENGTH  
 Example:  
 020 - 2M  
 060 - 6M  
 100 - 10M

COUPLING NUT **3**  
 blank and 3-standard (BRASS)  
 1 - STAINLESS STEEL  
 5 - DELRIN  
 7 - TEFLON COAT

PLUG MATERIAL **4**  
 blank-standard (BLACK)  
 A-GREY  
 Y-YELLOW  
 H-standard with ID carrier **7**

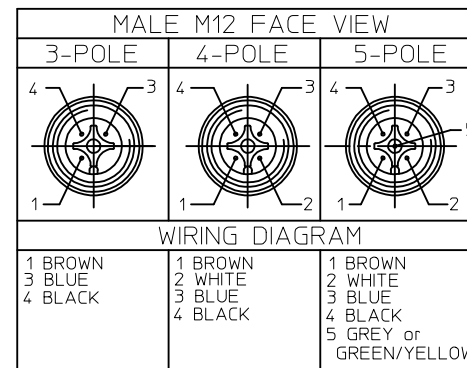
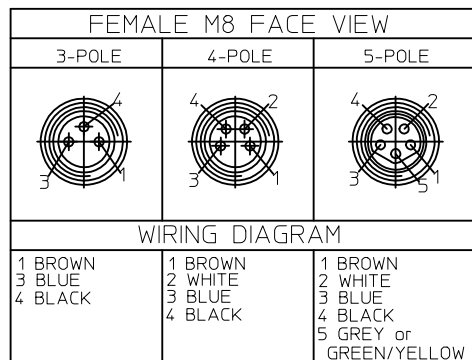





Table of length tolerances mm

OVER	UP TO	TOLERANCE +
0	305	+19
305	915	+45
915	1830	+56
1830	3660	+89
3660	7320	+165
7320	14640	+317
14640	30500	+610
30500	-	+2% OF LENGTH

ORIGINAL RELEASE EC NO: IPG2013-1417 DRWN:MDYSZEWSKA 2013/03/11 CHKD:JMARSZALEK 2013/03/11 APPR:MIWASIECZKO 2013/03/12	QUALITY SYMBOLS ▽=0 ◻=0	GENERAL TOLERANCES (UNLESS SPECIFIED)		DIMENSION STYLE MM ONLY		SCALE	DESIGN UNITS METRIC	FIRST ANGLE PROJECTION		
								TITLE		
								CSE M8 M12 XP XC FE MA XM DE		
								DOCUMENT NO.		SHEET NO.
								SD-120087-045		2 OF 3
A1	REV	DRAFT WHERE APPLICABLE MUST REMAIN WITHIN DIMENSIONS		SEE CHART		THIS DRAWING CONTAINS INFORMATION THAT IS PROPRIETARY TO MOLEX INCORPORATED AND SHOULD NOT BE USED WITHOUT WRITTEN PERMISSION				

9 8 7 6 5 4 3 2 1

	10	9	8	7	6	5	4	3	2	1
F	1200878404	483030E02M003	1200878419	483030P02M070	1200878440	483032E02M010	1200878465	484030E02M030H		
	1200878405	483030E02M005	1200878420	483030P02M100	1200280333	483032E02M020	1200878466	484030E02M035		
	1200878038	483030E02M006	1200878121	483030P82M003	1200878441	483032E02M050	1200878467	484030E02M040		
	1200878406	483030E02M010	1200280411	483030P82M0037	1200878442	483032E02M100	1200878468	484030E02M050		
	1200878407	483030E02M010H	1200878045	483030P82M0067	1200878443	483032E02M150	1200878469	484030E02M100		
	1200878039	483030E02M020	1200280869	483030P82M0107	1200878202	483032H69M010	1200878565	484030H08M006		
	1200878408	483030E02M030	1200280532	483030P82M030	1200878204	483032H69M040	1200878516	484030H08M010		
	1200878409	483030E02M050	1200878421	483031E02M006	1200878205	483032H69M050	1200878566	484030H08M020		
	1200878410	483030E02M100	1200878422	483031E02M010	1200878207	483032H69M100	1200878525	484030H08M030		
E	1200875004	483030E18M010H	1200878423	483031E02M010H	1200878054	483032I02M006	1200878567	484030H08M050		
	1200868220	483030H08M003	1200878167	483031E02M020	1200878444	483032I02M010	1200878519	484030I02M006		
	1200868221	483030H08M006	1200878424	483031E02M030	1200878445	483032I02M050	1200878520	484030I02M010		
	1200878510	483030H08M010	1200878425	483031E02M050	1200878446	483032P02M006	1200878470	484030I02M030		
	1200878544	483030H08M010Y	1200878426	483031E02M050G	1200878447	483032P02M010	1200878523	484030I02M050		
	1200878255	483030H08M020	1200878560	483031H08M006	1200878448	483032P02M020	1200878471	484030P02M006		
	1200878524	483030H08M030	1200878513	483031H08M010	1200878449	483032P02M030	1200878472	484030P02M010		
	1200878511	483030H08M050	1200878561	483031H08M020	1200878450	483032P02M050	1200878473	484030P02M020		
	1200878512	483030H08M100	1200878514	483031H08M050	1200878061	483032P82M0037	1200878474	484030P02M030		
D	1200878411	483030I02M003	1200878515	483031H08M100	1200878062	483032P82M0067	1200878475	484030P02M050	1200878484	484031I02M030
	1200280282	483030I02M006	1200878427	483031I02M006	1200878451	483033E02M020	1200878476	484030P02M100	1200878485	484031P02M003
	1200280056	483030I02M010	1200280078	483031I02M010	1200878452	483033I02M006	1200280826	484030P82M0037	1200878486	484031P02M006
	1200878549	483030I02M010Y	1200878533	483031I02M010Y	1200878453	483033I02M010	1200878571	484030P82M0037Y	1200878487	484031P02M010
	1200878412	483030I02M015	1200878428	483031I02M015	1200878123	483033I02M020	1200280883	484030P82M0067	1200878488	484031P02M020
	1200280057	483030I02M020	1200878429	483031I02M020	1200878454	483033I02M030	1200280884	484030P82M0107	1200875028	484031P82M0037
	1200878531	483030I02M020Y	1200878430	483031I02M030	1200878455	483033P02M010	1200878477	484031E02M006	1200875045	484031P82M0067
	1200280058	483030I02M030	1200878431	483031I02M050	1200878456	483033P02M020	1200878478	484031E02M010	1200280885	484031P82M0107
	1200280059	483030I02M050	1200878432	483031P02M003	1200878457	483033P02M050	1200878479	484031E02M010H	1200878548	484031P82M0107Y
C	1200878532	483030I02M050Y	1200878433	483031P02M006	1200878459	484030E02M003	1200878480	484031E02M020	1200878489	484032E02M003
	1200668183	483030P02M003	1200878434	483031P02M010	1200878460	484030E02M005	1200878481	484031E02M020H	1200878490	484032E02M006
	1200878413	483030P02M006	1200878435	483031P02M020	1200878461	484030E02M006	1200878482	484031E02M030	1200878491	484032E02M010
	1200878414	483030P02M010	1200878436	483031P02M030	1200878073	484030E02M010	1200878483	484031E02M050	1200878252	484032E02M050
	1200878415	483030P02M020	1200878437	483031P02M050	1200878462	484030E02M015	1200878562	484031H08M006	1200878253	484032E02M100
	1200878416	483030P02M030	1200878438	483031P02M100	1200878463	484030E02M020	1200878563	484031H08M010	1200878492	484032P02M020
	1200878417	483030P02M050	1200878122	483031P82M003	1200878464	484030E02M025	1200878564	484031H08M020	1200878493	484033P02M030
	1200878418	483030P02M065	1200878439	483032E02M006	1200878074	484030E02M030	1200878517	484031H08M050	1200878587	484031P02M050

<b>ADDED NEW P/N</b> EC NO: IPG2013-1417 DRWN:MD/SZEWSKA 2013/03/11 CHKD:JMARSZALEK 2013/03/11 APPR:MIWASIECZKO 2013/03/12	QUALITY SYMBOLS  = 0  = 0	GENERAL TOLERANCES (UNLESS SPECIFIED)		DIMENSION STYLE <b>MM ONLY</b>		SCALE	DESIGN UNITS <b>METRIC</b>	 <b>FIRST ANGLE PROJECTION</b>			
		4 PLACES ± --- ± --- 3 PLACES ± --- ± --- 2 PLACES ± --- ± --- 1 PLACE ± --- ± --- 0 PLACE ± --- ± ---	mm INCH ± --- ± --- ± --- ± --- ± --- ± --- ± --- ± ---	DRAWN BY HWALCZAK	DATE 2012/11/24	TITLE <b>CSE M8 M12 XP XC FE MA XM DE</b>					
				CHECKED BY JMARSZALEK	DATE 2013/01/14						
				APPROVED BY MIWASIECZKO	DATE 2013/01/15			MATERIAL NO. <b>SEE CHART</b>		DOCUMENT NO. <b>SD-120087-045</b>	SHEET NO. <b>3 OF 3</b>