

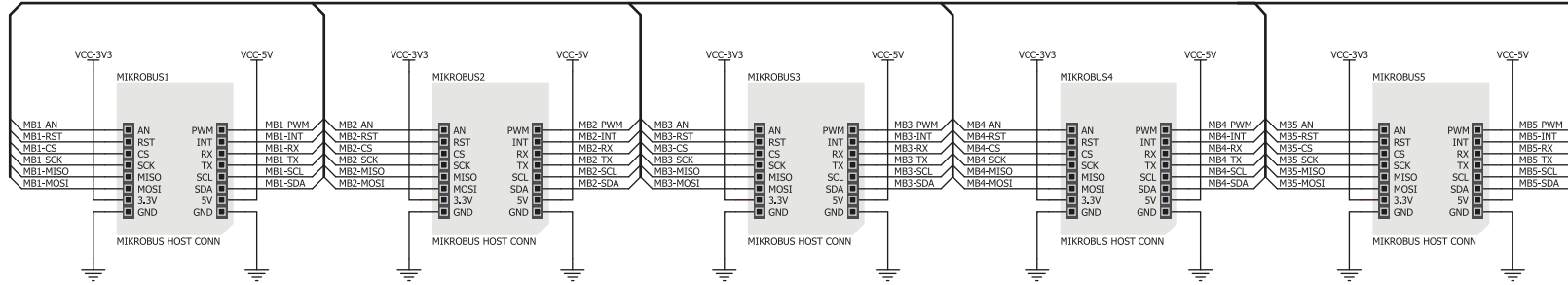

for TIVA v8 DEVELOPMENT BOARD

SCHEMATIC

mikroBUS sockets



CODEGRIP PDU



- PTD10-TRACEDATA-3
- PTD9-TRACEDATA-2
- PTD8-TRACEDATA-1
- PTD7-TRACEDATA-0
- PTD6-TRACECLK
- PTD5-CONN-RESET
- PTD4-TDI
- PTD3-SWDIO/TDO/MISO
- PTD2-SWDIO/TMS/MOSI
- PTD1-SWDCLK/TCK/SCK
- PTD0-CS
- EXT-PROG-DETECT
- PTB7-100/500mA
- PTB6-EN-CHARGER
- PTB4-DAC-SENSE
- PTB3-I2CO-SDA
- PTB2-I2CO-SCL
- PTB1-PROG-MUX
- UAPD-USB1_P
- UAPD-USB1_N
- UAPD-USB-VBUS

TFT Connector

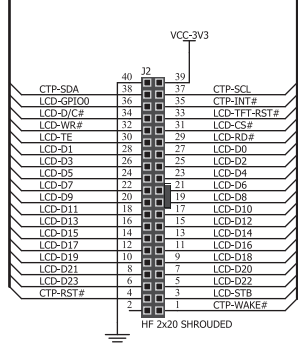

LCD

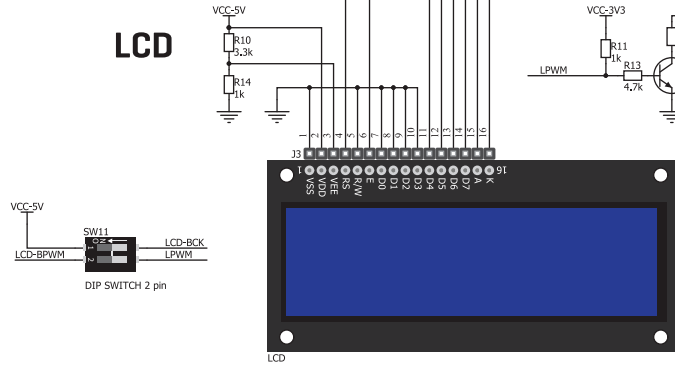

Ethernet

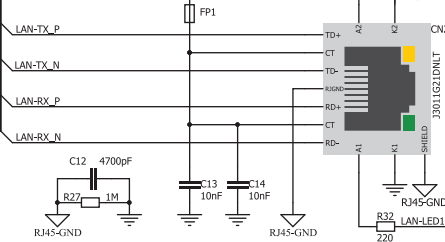

USB POWER/DEBUG

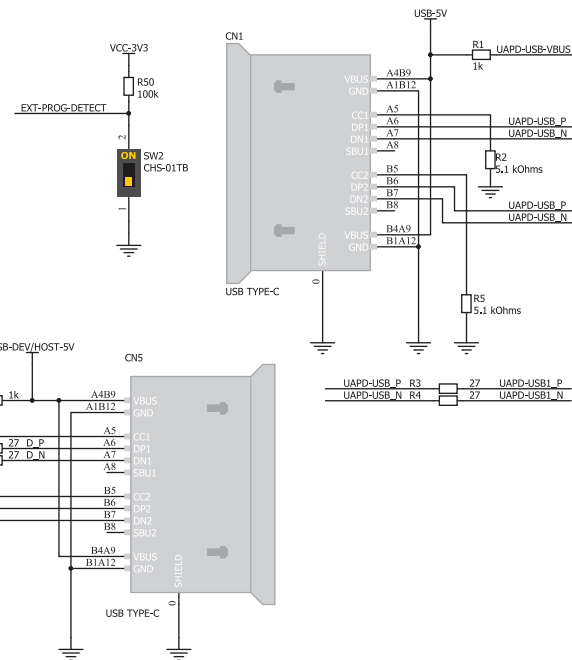

BATTERY

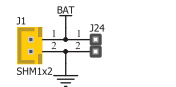

POWER 12VDC

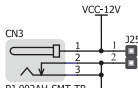

USB Host / Device

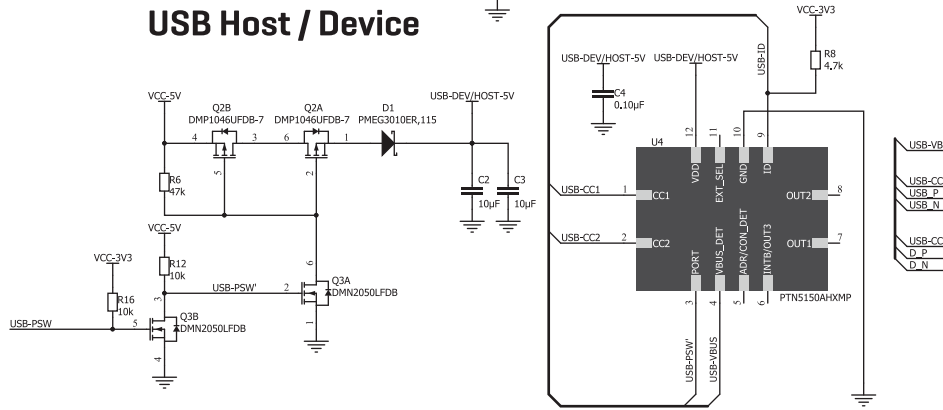

DBG SELECTION

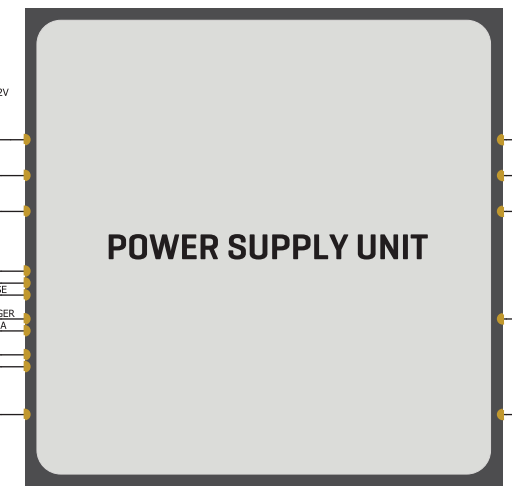
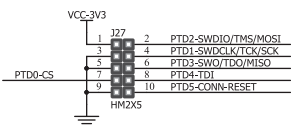

POWER SUPPLY UNIT

- PTB2-I2CO-SCL
- PTB3-I2CO-SDA
- PTB4-DAC-SENSE
- PTB6-EN-CHARGER
- PTB7-100/500mA
- PWR_TPAD
- RST_TPAD
- PTD5-CONN-RESET

MCU Card Socket

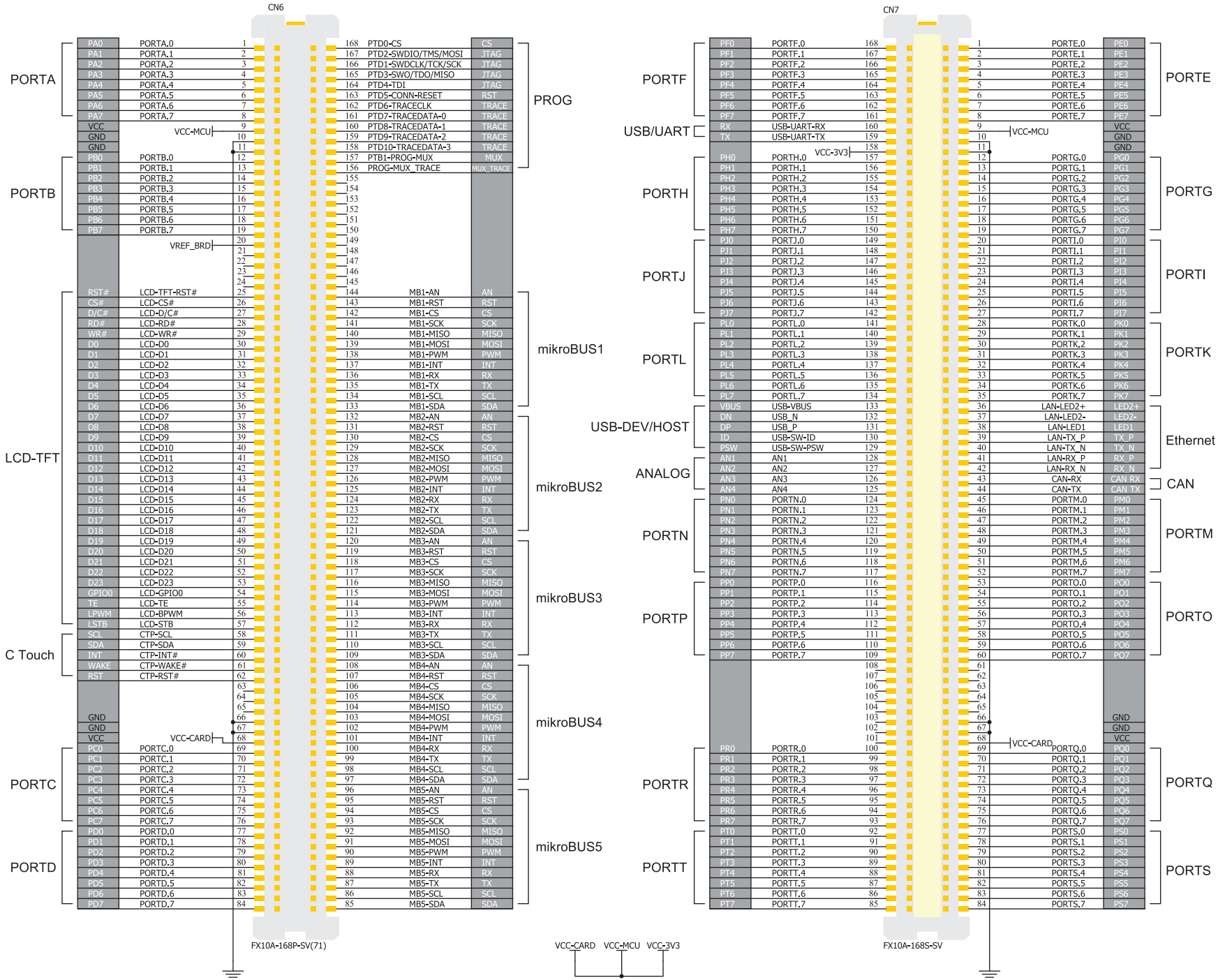
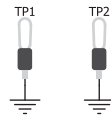

HW. REV. 1.1.11

