

Part No. M310220

Wi-Fi / BT / Zigbee Ceramic Antennas

2.4 GHz

Supports: Wi-Fi applications, Agriculture, Automotive, Bluetooth, Zigbee, WLAN, Smart Home, Healthcare, Digital Signage

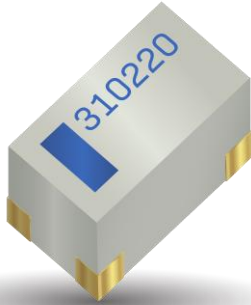

Ethertronics' series of Ceramic Isolated Magnetic Dipole™ (IMD) antennas deliver on the key needs of device designers for higher functionality and performance in smaller/thinner designs. These innovative antennas provide compelling advantages for Bluetooth® enabled cell phones, media players and other mobile devices.

Real-World Performance and Implementation

Ceramic antennas may look alike on the outside, but the important difference is inside. Other antennas may contain simple PiFA or monopole designs that interact with their surroundings, complicating layout or changing performance with use position. Ethertronics' antennas utilize patented IMD technology to deliver a unique size and performance combination.

Ceramic Wi-Fi / Bluetooth Antenna

2400 – 2485 MHz

Greater Flexibility

Ethertronics' first-in-class IMD technology enables you to develop concept designs that are more advanced and that deliver superior performance in reception critical applications.

Electrical Specifications

Typical performance on 40 x 60 mm PCB

Frequency (MHz)	2400 – 2485
Peak Gain	1.7 dBi
Average Efficiency	67%
VSWR Match	2.0:1 max
Feed Point Impedance	50 ohms unbalanced
Polarization	Linear
Power Handling	0.5 Watt CW

KEY BENEFITS

Stay-in-Tune

IMD antenna technology provides superior RF field containment, resulting in less interaction with surrounding components.

Quicker Time-to-Market

By optimizing antenna size, performance and emissions, customer and regulatory specifications are more easily met.

Reliability

Products are the latest RoHS version compliant.

APPLICATIONS

- Embedded design
- Cellular, Headsets, Tablets
- Gateway, Access Point
- Handheld
- Telematics
- Tracking
- Healthcare
- M2M, Industrial devices
- Smart Grid
- OBD-II

Mechanical Specifications & Ordering Part Number

Ordering Part Number	M310220
Size (mm)	3.00 x 1.50 x 1.08
Mounting	Surface mounted
Weight (grams)	0.1
Packaging	Tape & Reel, M310220 – 1,000 pieces per reel
Demo Board	M310220-01



2.4 GHz Ethertronics' Embedded Antenna Specifications
Ethertronics produces a wide variety of standard and custom antennas to meet user needs.

Antenna Dimensions

Typical antenna dimensions (mm)

Part Number	A (mm)	B (mm)	C (mm)
M310220	3.00 ± 0.2	1.50 ± 0.2	1.08 ± 0.1

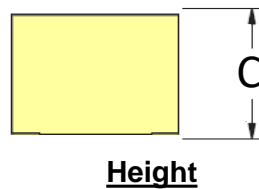
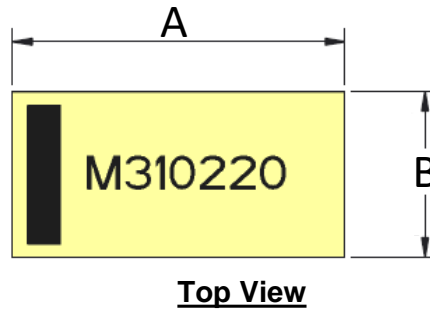
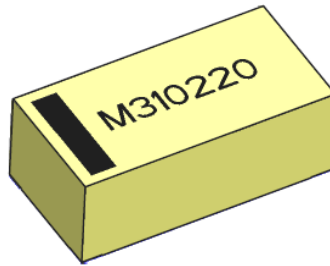

Pin	Description
1	Feed
2	Ground

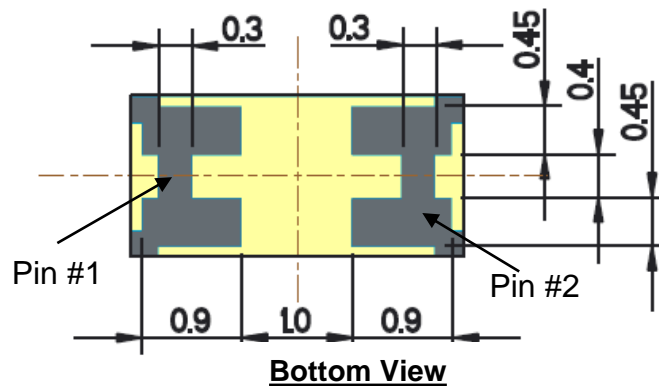



2.4 GHz Ethertronics' Embedded Antenna Specifications
Ethertronics produces a wide variety of standard and custom antennas to meet user needs.

VSWR, Efficiency Plots

Typical performance on 40 x 60 mm PCB

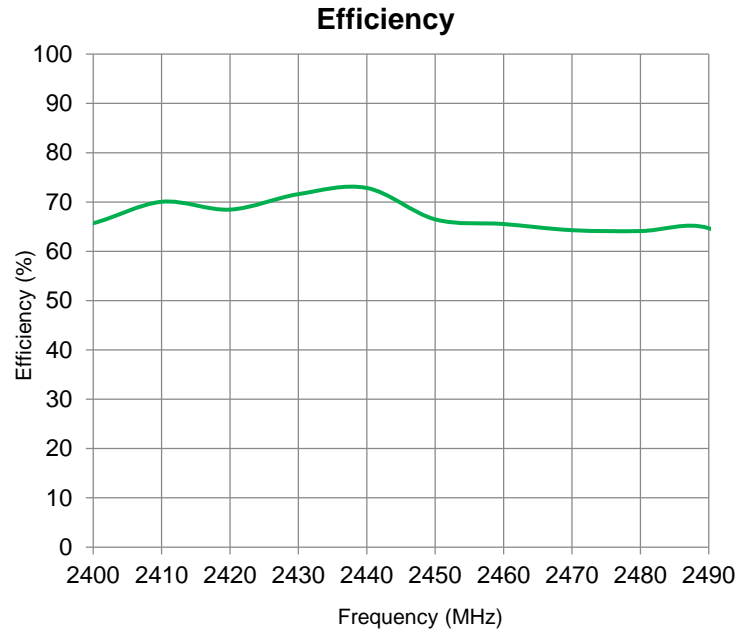
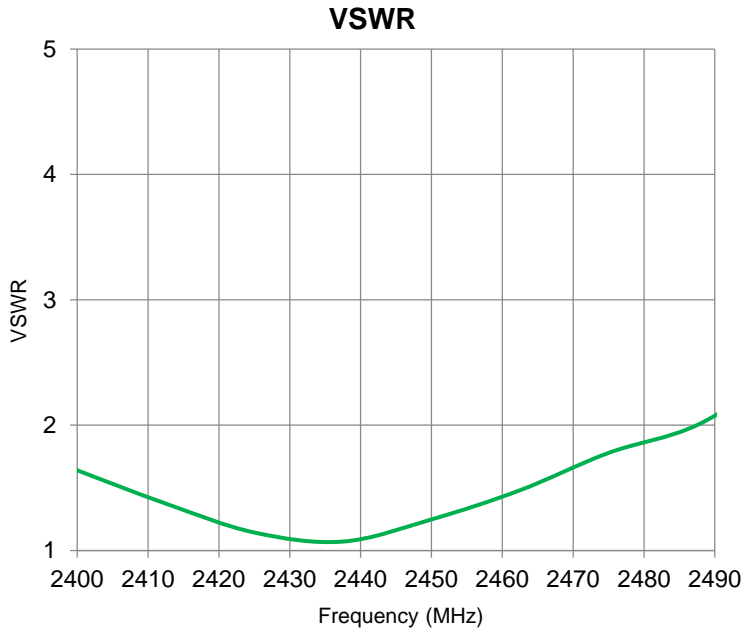

Antenna Radiation Patterns

Typical performance on 40 x 60 mm PCB

Measured @ 2440 MHz

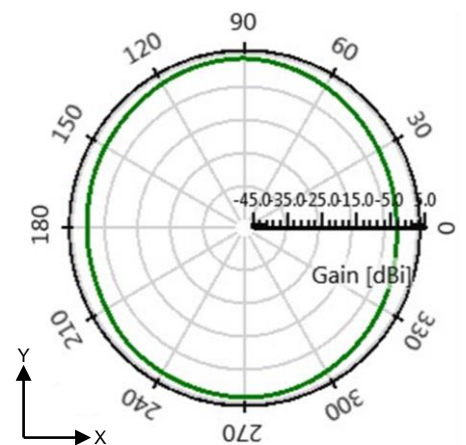
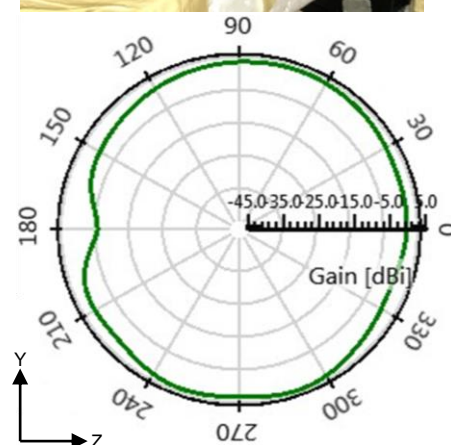
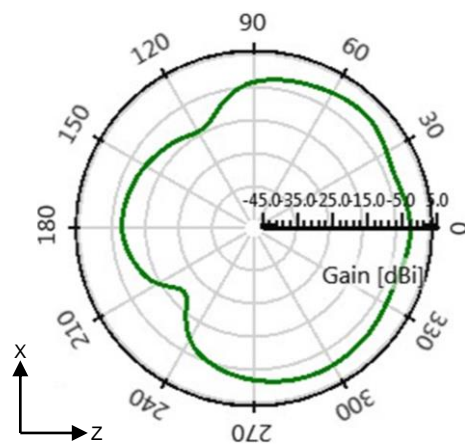



2.4 GHz Ethertronics' Embedded Antenna Specifications

Ethertronics produces a wide variety of standard and custom antennas to meet user needs.

Antenna Layout

Typical layout dimensions (mm)

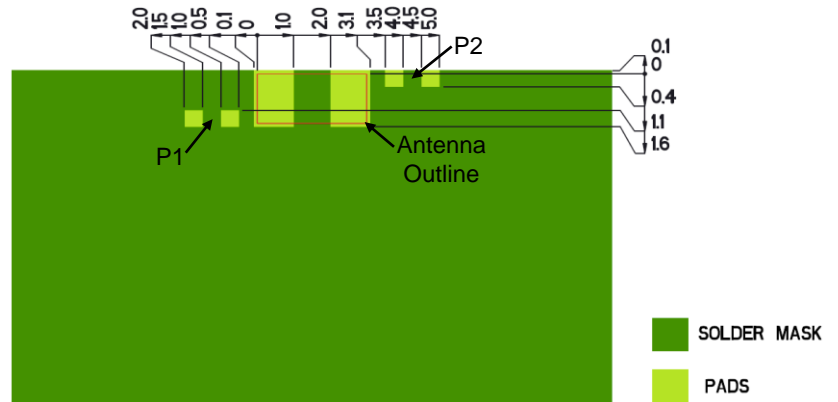
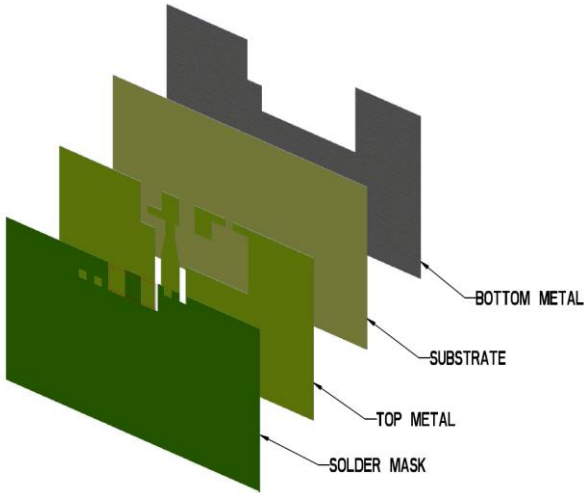

- Additional VIAS: Diam. 0.2mm to be placed around antenna, (no vias on transmission lines).
- Via holes must be covered by solder mask

Pin Descriptions

Pin#	Description
1	Feed
2	Ground

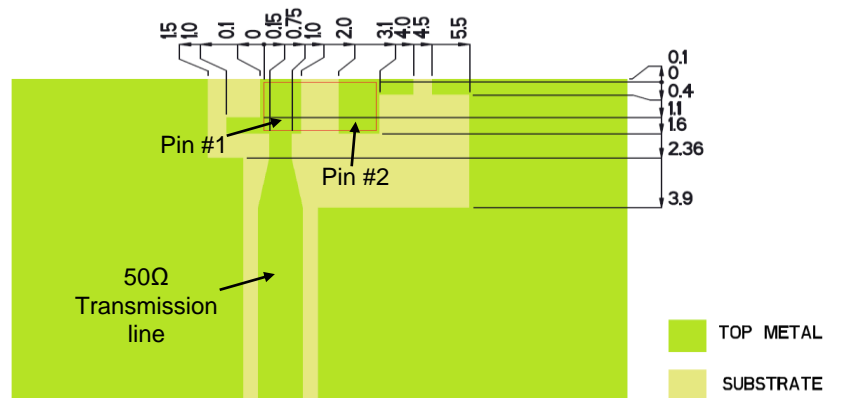

Matching Network (Demo Board)

Component	Value	Tolerance
P1	4.7pF	±0.05pF
P2	2.7pF	±0.05pF

*Actual matching values depend on customer design

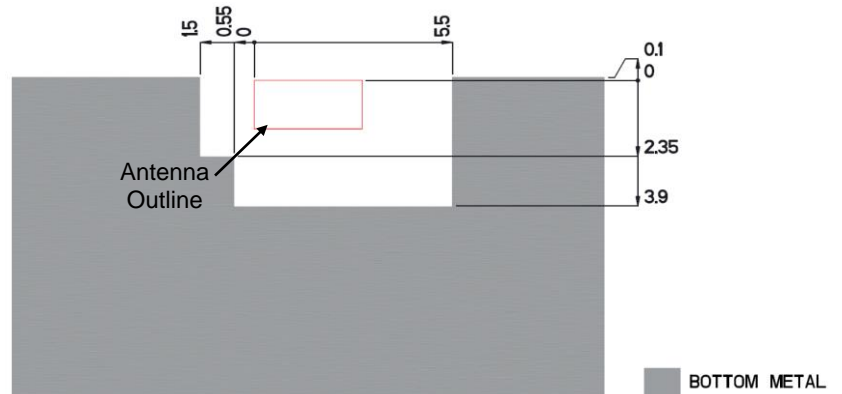
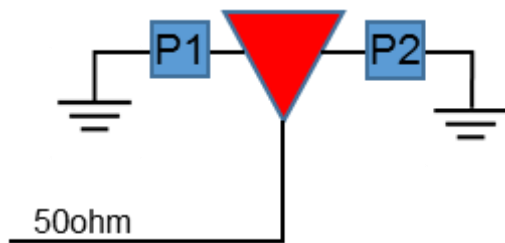



2.4 GHz Ethertronics' Embedded Antenna Specifications

Ethertronics produces a wide variety of standard and custom antennas to meet user needs.

Antenna Layout Tips (General reference)

Important, layout guidelines for correct operation of Ethertronics Ceramic Antennas. Please read guidelines below before laying out the antenna in a device. Figure 1 shows the typical antenna layout. Figure 2 shows Ethertronics' antenna layout.

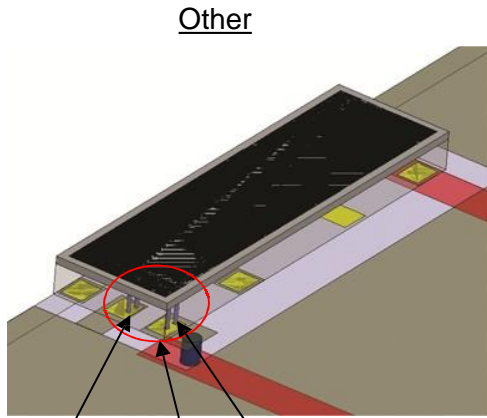

Shorting pin Feed pin
Antenna tuning loop:
Figure 1
Typical Antenna Layout

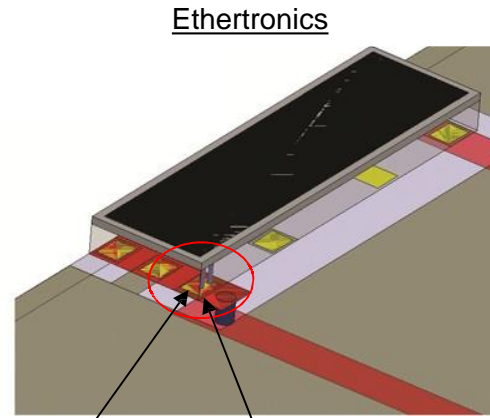

Shorting pin and feed pin are shared in Ethertronics ceramic antennas

Figure 2
Ethertronics Antenna Layout
(Required)

- The antenna tuning loop is formed by the PCB layout.
- The feed pin and shorting pin are combined because it requires very close proximity to achieve more band- width.



2.4 GHz Ethertronics' Embedded Antenna Specifications
Ethertronics produces a wide variety of standard and custom antennas to meet user needs.

Antenna Demo Board

Typical layout dimensions (mm)

Part Number	A (mm)	B (mm)	C (mm)
M310220-01	60.0	40.0	30.0

