



LED HIGH POWER

M07 CoB Product Series

Data Sheet

Created Date: 10 / 30 / 2013
Revision: 1.0, 12 / 10 / 2013

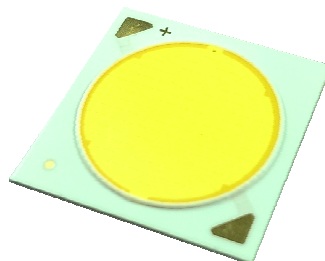

LED HIGH POWER M07 Product Series

1. Description

The LiteON CoB Product series is a revolutionary, energy efficient and ultra-compact new light source, combining the lifetime and reliability advantages of Light Emitting Diodes with the brightness of conventional lighting. It gives you total design freedom and unmatched brightness, creating a new opportunities for solid state lighting to displace conventional lighting technologies.

1.1 Features

- Compact high flux density light source
- Uniform high quality illumination
- Streamlined thermal path
- MacAdam compliant binning structure
More energy efficient than incandescent, halogen and fluorescent lamps
- Instant light with unlimited dimming
- RoHS compliant and Pb free

1.2 Benefits Features

- Enhanced optical control
- Clean white light without pixilation
- Uniform consistent white light
- Significantly reduced thermal resistance and increased operating temperatures
- Lower operating costs
- Reduced maintenance costs
- ESD rating is 8KV in HBM

1.3 Naming Rule

L T PL - M 0 7 4 X X Z S X X - X X

Code1
Code2
Code3
Code4
Code5
Code6

Code 1: Product Line

PL: High Power LED.

Code 2: Package Type/Platform

M07: Ceramic substrate with 27x27mm square.

Code 3: Light Emitting Surface

4: 22mm excluding dam

Code 4: Product Series

52: 52 Series
80: 80 Series

Code5: Color Temperature

27: 2700K at 85degC
30: 3000K at 85degC
40: 4000K at 85degC
50: 5000K at 85degC
57: 5700K at 85degC
65: 6500K at 85 degC

Note: The Color Temperature follow ANSI C78.377A Doc.

Code6: Hue Bin by MacAdam Ellipses Step

T0: 3-Step Mac Adam Ellipse+Main Lumen Bin (2700K~4000K)
S1: 5-Step Mac Adam Ellipse/ANSI+Full Lumen Bins (2700K~4000K)
F1: 5-Step Mac Adam Ellipse+Full Lumen Bins (5000K~6500K)
S1: ANSI+Full Lumen Bins (5000K~6500K)

LED HIGH POWER M07 Product Series

1.4 Product List

Part Number	Product Series	CCT	CRI	Color Bin			Lumen Bin	
				3SDCM	5SDCM	ANSI	-8%~+8%	-15%~+15%
LTPL-M07452ZS27-T0	52	2700K	80	☆			☆	
LTPL-M07452ZS27-S1	52	2700K	80		☆	☆		☆
LTPL-M07452ZS30-T0	52	3000K	80	☆			☆	
LTPL-M07452ZS30-S1	52	3000K	80		☆	☆		☆
LTPL-M07452ZS40-T0	52	4000K	80	☆			☆	
LTPL-M07452ZS40-S1	52	4000K	80		☆	☆		☆
LTPL-M07452ZS50-F1	52	5000K	80		☆			☆
LTPL-M07452ZS50-S1	52	5000K	80			☆		☆
LTPL-M07452ZS57-F1	52	5700K	80		☆			☆
LTPL-M07452ZS57-S1	52	5700K	80			☆		☆
LTPL-M07452ZS65-F1	52	6500K	80		☆			☆
LTPL-M07452ZS65-S1	52	6500K	80			☆		☆
LTPL-M07480ZS27-T0	80	2700K	80	☆			☆	
LTPL-M07480ZS27-S1	80	2700K	80		☆	☆		☆
LTPL-M07480ZS30-T0	80	3000K	80	☆			☆	
LTPL-M07480ZS30-S1	80	3000K	80		☆	☆		☆
LTPL-M07480ZS40-T0	80	4000K	80	☆			☆	
LTPL-M07480ZS40-S1	80	4000K	80		☆	☆		☆
LTPL-M07480ZS50-F1	80	5000K	80		☆			☆
LTPL-M07480ZS50-S1	80	5000K	80			☆		☆
LTPL-M07480ZS57-F1	80	5700K	80		☆			☆
LTPL-M07480ZS57-S1	80	5700K	80			☆		☆
LTPL-M07480ZS65-F1	80	6500K	80		☆			☆
LTPL-M07480ZS65-S1	80	6500K	80			☆		☆

LED HIGH POWER M07 Product Series

2. Outline Dimensions

2.1 Form Factor of M074 series CoB

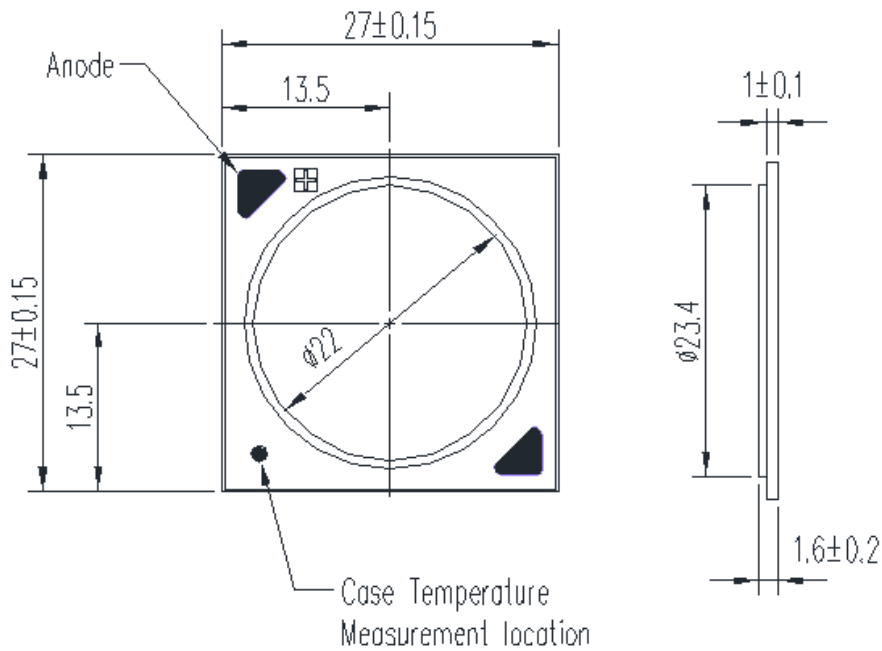

Notes

1. All dimensions are in millimeters.
2. Tolerance is ± 0.3 mm unless otherwise noted.
3. LED of equivalent circuit means all series/parallel in CoB package.

2.2 Internal Equivalent Circuit

52 Series Product

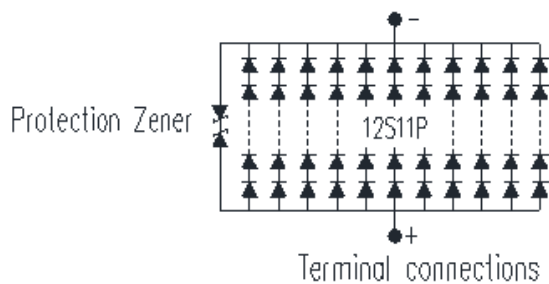

80 Series Product

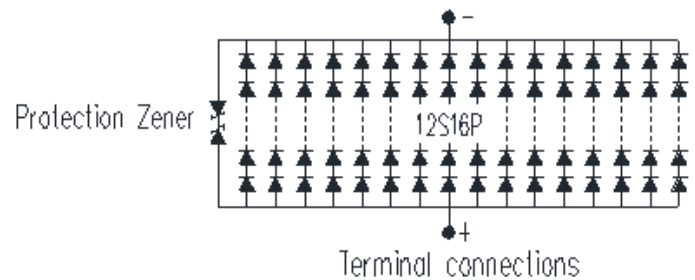

LED HIGH POWER M07 Product Series

3. Absolute Maximum Ratings at Ta=25°C

Parameter	Symbol	Product Series	Rating	Unit
Power Dissipation	P _O	52	86	W
		80	129	
Forward Current	I _F	52	2200	mA
		80	3200	
Junction Temperature	T _j		125	°C
Thermal Resistance, Junction-Case	R _{th, J-C}	52	0.32	°C/W
		80	0.24	
Operating Temperature Range	T _{opr}		-40 to 85	°C
Storage Temperature Range	T _{stg}		-40 to 100	°C
Breakdown Voltage(DC)	V _B		2.25	KV
Electrostatic Discharge	ESD		8	KV

Notes

1. The pulse mode condition is 1/10 duty cycle with 100 msec pulse width.
2. Forbid to be operated at reverse voltage condition.
3. ESD spec is reference to AEC-Q101-001 HBM.
4. The unit of R_{th} is °C/W electrical.
5. The M07 CoB is recommended soldering temperature under 350degC and could not over 3.5sec.

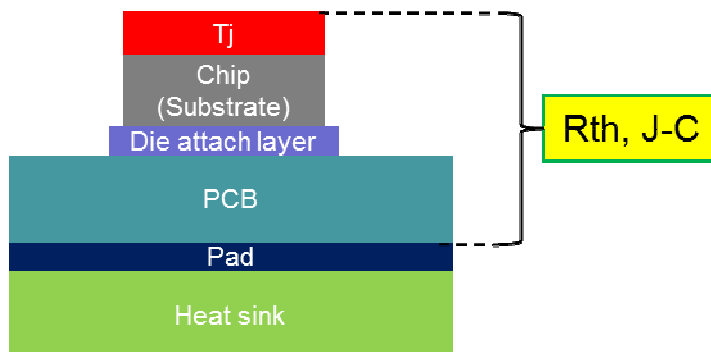

LED HIGH POWER M07 Product Series

4. Electro-Optical Characteristics

4.1 Typical Performance

■ 52 Series Product

Dominant CCT	Product Series	Current (mA)	V _F (V) @ 25°C	Flux(lm) @ 25°C	V _F (V) @ 85°C	Flux(lm) @ 85°C	Eff.(lm/W) @ 25°C	Eff.(lm/W) @ 85°C
2700K	52	1400	37.7	6839	36.9	5922	130	115
3000K	52	1400	37.7	7122	36.9	6167	135	120
4000K	52	1400	37.7	7550	36.9	6538	143	127
5000K	52	1400	37.7	7621	36.9	6599	144	129
5700K	52	1400	37.7	7483	36.9	6480	142	125
6500K	52	1400	37.7	7550	36.9	6538	143	127

■ 80 Series Product

Dominant CCT	Product Series	Current (mA)	V _F (V) @ 25°C	Flux(lm) @ 25°C	V _F (V) @ 85°C	Flux(lm) @ 85°C	Eff.(lm/W) @ 25°C	Eff.(lm/W) @ 85°C
2700K	80	2050	37.7	9371	36.9	8119	121	107
3000K	80	2050	37.7	9759	36.9	8455	126	112
4000K	80	2050	37.7	10345	36.9	8963	134	118
5000K	80	2050	37.7	10442	36.9	9047	135	120
5700K	80	2050	37.7	10253	36.9	8884	133	117
6500K	80	2050	37.7	10345	36.9	8963	134	118

Notes

1. All of V_F value are typical, the real bin range please refer page 13 "V_F Binning Parameter".
2. All of flux value are typical, the real bin range please refer page 12 "Flux Binning Parameter".
3. Tolerance of flux is ±7%, tolerance of CCX/CCY is ±0.007, tolerance of CRI is ±2, and tolerance of V_F is ±3%.
4. Typical viewing angle is 120deg.

LED HIGH POWER M07 Product Series

4.2 Forward Current vs. Lumen and Voltage

■ 52 Series Product

Current (mA)	V _F (V)	Flux (lm)					
		2700K	3000K	4000K	5000K	5700K	6500K
		CRI>80	CRI>80	CRI>80	CRI>80	CRI>80	CRI>80
100	32.4	402	419	444	448	440	444
200	33.0	958	998	1058	1068	1049	1058
300	33.5	1504	1566	1660	1676	1645	1660
500	34.5	2557	2663	2823	2849	2798	2823
700	35.3	3562	3709	3932	3969	3897	3932
1000	36.4	5010	5218	5531	5583	5482	5531
1200	37.0	5997	6245	6620	6682	6561	6620
1400	37.7	6839	7122	7550	7621	7483	7550
1600	38.1	7619	7934	8411	8490	8336	8411
1800	38.7	8422	8770	9297	9384	9214	9297
2000	39.2	9146	9524	10096	10191	10006	10096
2200	39.8	9838	10245	10861	10963	10764	10861

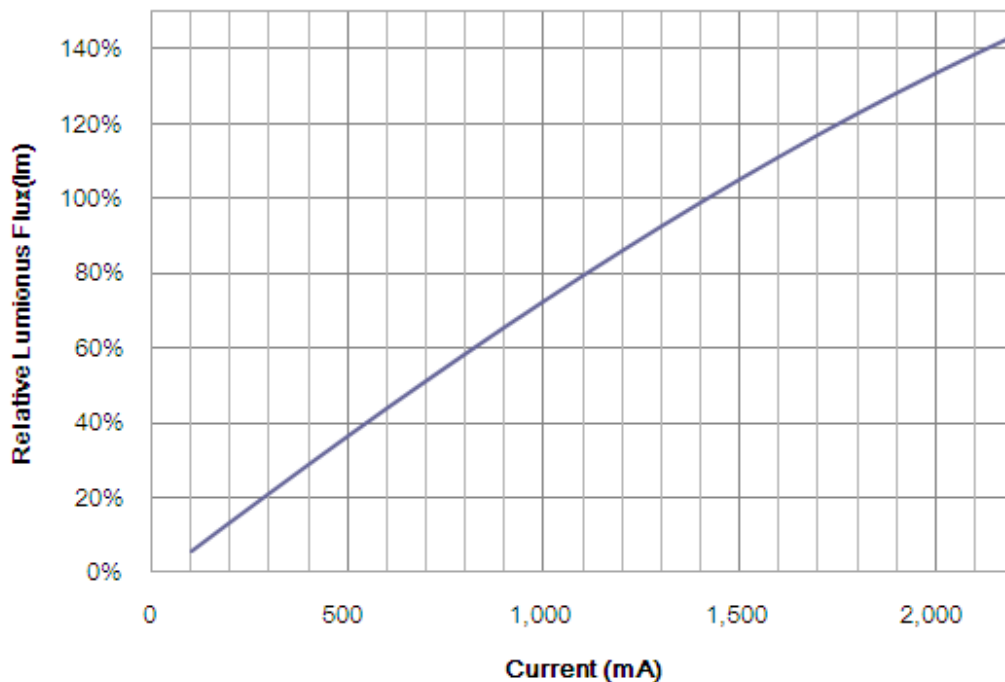

LED HIGH POWER M07 Product Series

■ 80 Series Product

Current (mA)	V _F (V)	Flux (lm)					
		2700K	3000K	4000K	5000K	5700K	6500K
		CRI>80	CRI>80	CRI>80	CRI>80	CRI>80	CRI>80
100	31.2	570	594	629	635	624	629
200	31.6	1116	1162	1232	1243	1221	1232
300	32.0	1652	1721	1824	1841	1808	1824
500	32.8	2696	2807	2976	3004	2949	2976
750	33.8	3944	4107	4354	4395	4315	4354
1000	34.7	5129	5341	5662	5715	5611	5662
1250	35.5	6248	6507	6898	6962	6836	6898
1500	36.3	7301	7603	8060	8135	7988	8060
1750	37.0	8284	8627	9145	9231	9064	9145
2000	37.6	9197	9578	10153	10248	10063	10153
2050	37.7	9371	9759	10345	10442	10253	10345
2250	38.2	10038	10453	11082	11185	10983	11082
2500	38.7	10805	11252	11928	12040	11822	11928
2750	39.2	11496	11971	12691	12809	12578	12691
3000	39.6	12109	12610	13368	13493	13249	13368
3200	39.9	12543	13061	13846	13976	13723	13846

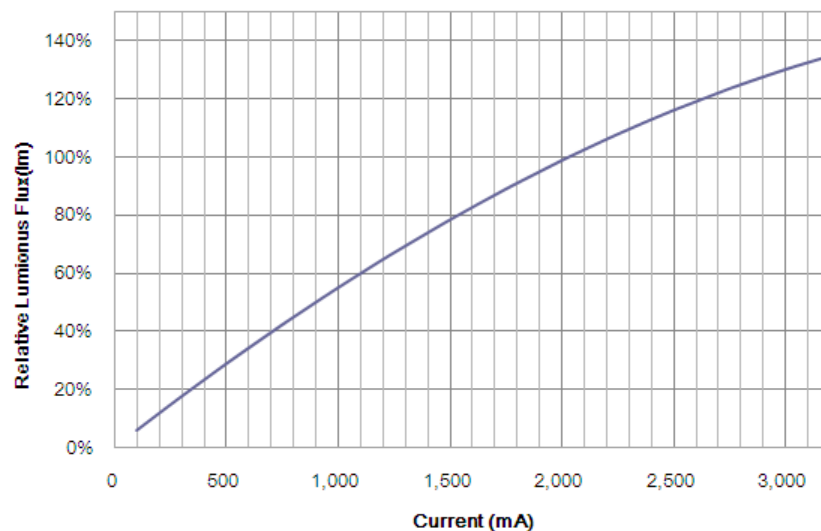

LED HIGH POWER M07 Product Series

4.3 Relative Spectral Power Distribution at Typical Current

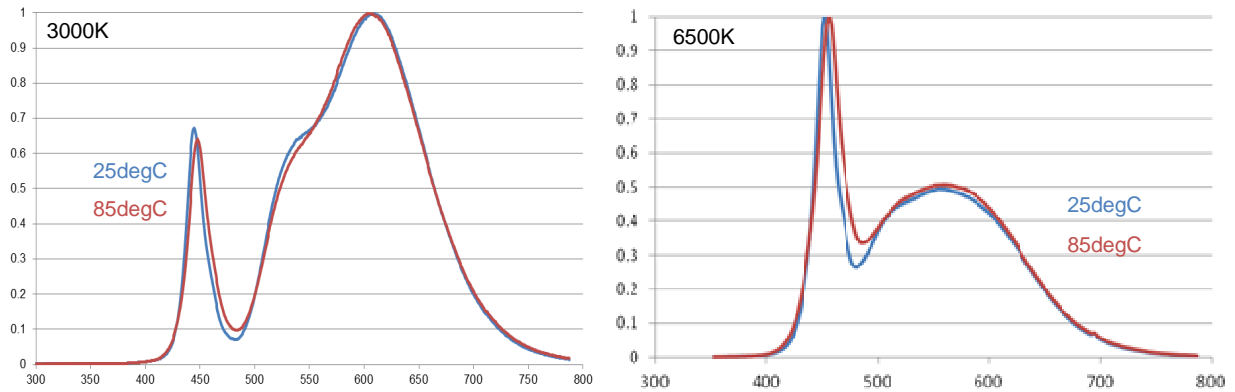

4.4 Radiation Characteristics

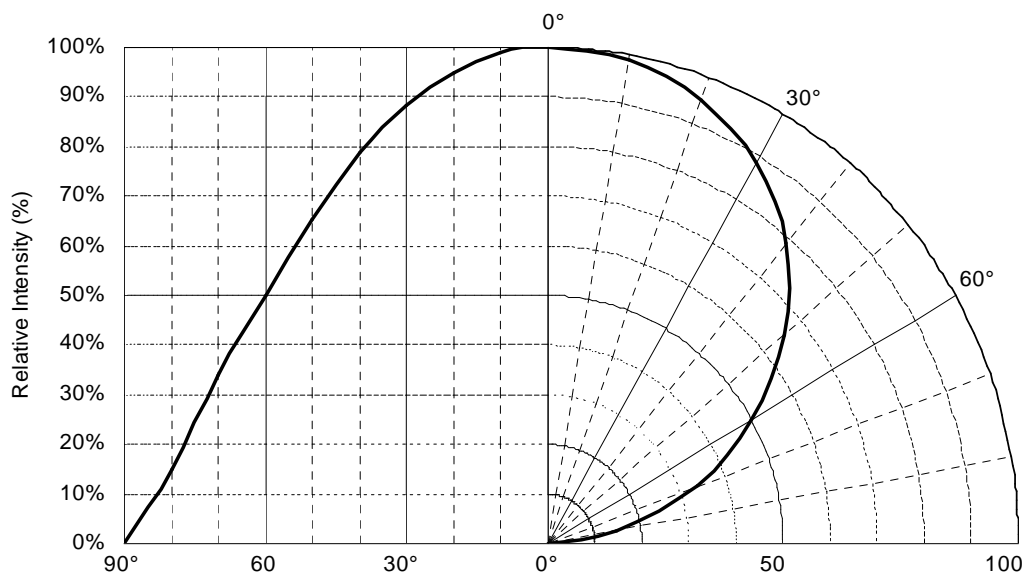

LED HIGH POWER M07 Product Series

4.5 Forward Current vs. Forward Voltage

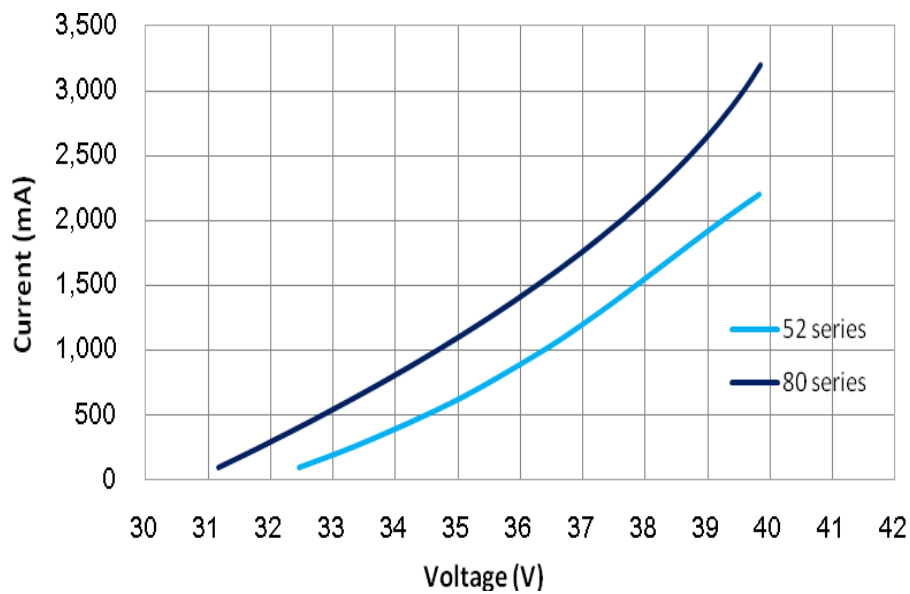

4.6 Forward Voltage vs. Case Temperature

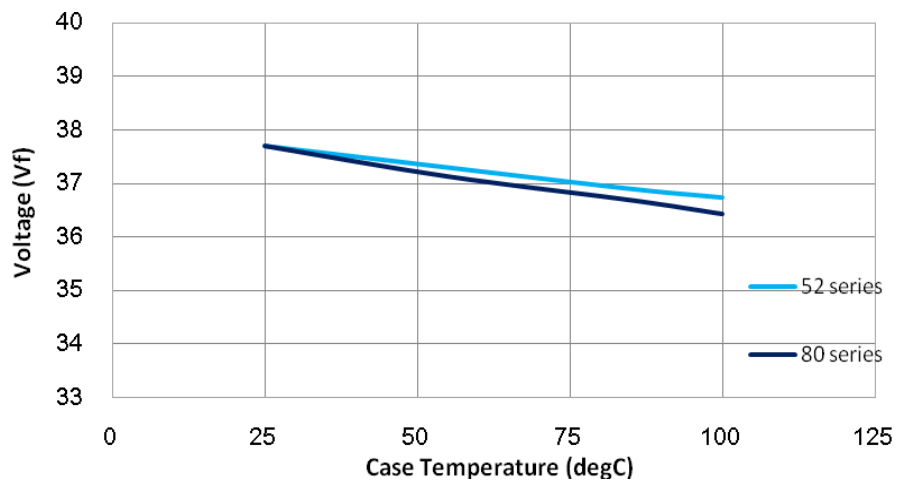

LED HIGH POWER M07 Product Series

4.7 Relative Intensity vs. Case Temperature

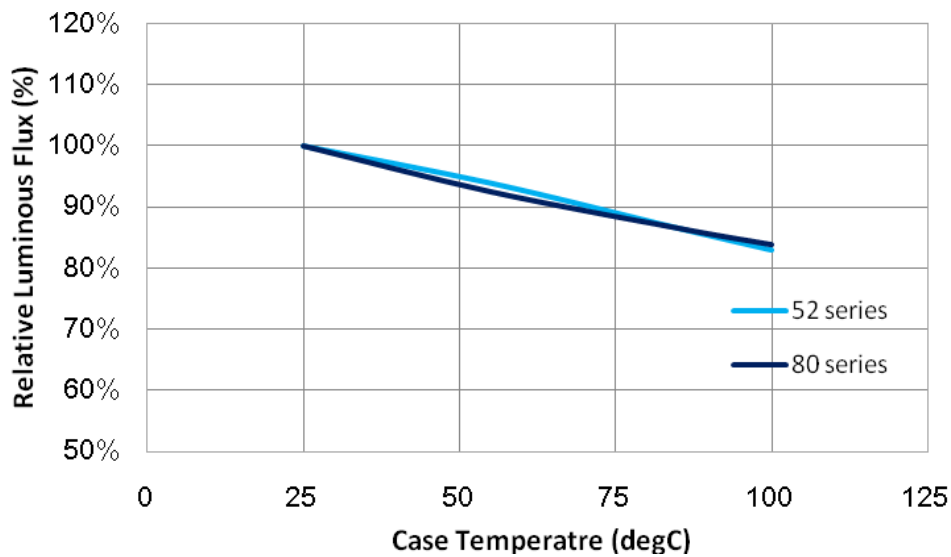

4.8 Forward Current Degrading Curve

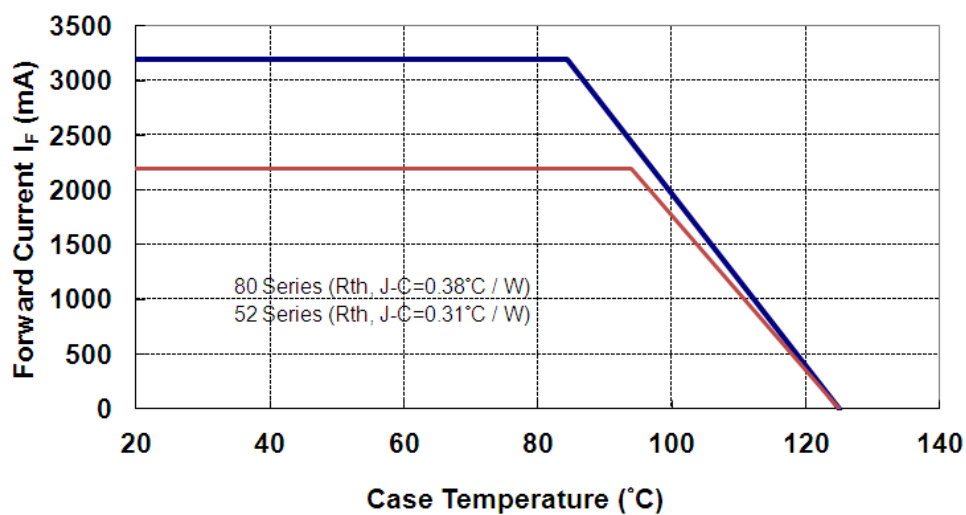

LED HIGH POWER M07 Product Series

5. CoB Binning Definition

■ Flux Binning Parameter (25degC)

Lumen CODE List of M07 Series Product			
Parameter	Code	Unit	Lumen
Luminous Flux	B	lm	5755
	C		6210
	D		6700
	E		7235
	F		7810
	G		8430
	H		9100
	I		9820
	J		10600
	K		11440
	L		12350

■ Example of M07 Series Product Bin (2700K 52 series)

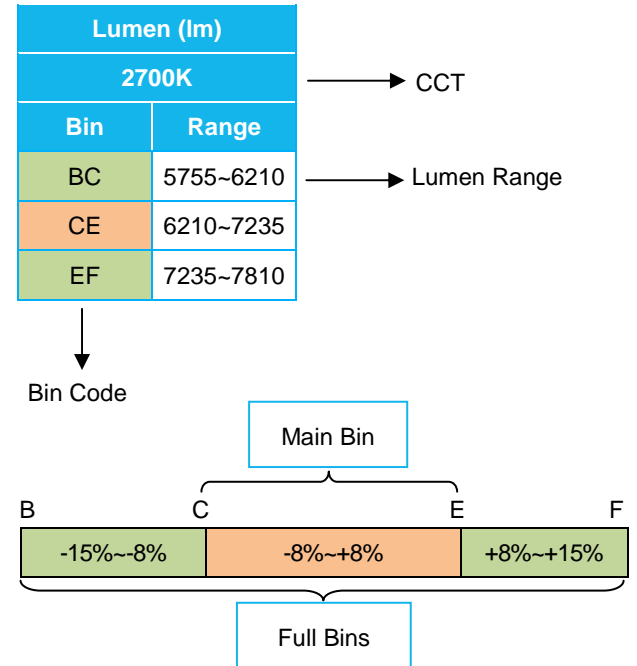

■ 52 Series Lumen Bin

Lumen (lm)											
2700K		3000K		4000K		5000K		5700K		6500K	
Bin	Range	Bin	Range	Bin	Range	Bin	Range	Bin	Range	Bin	Range
BC	5755~6210	CD	6210~6700	DE	6700~7235	DE	6700~7235	DE	6700~7235	DE	6700~7235
CE	6210~7235	DF	6700~7810	EG	7235~8430	EG	7235~8430	EG	7235~8430	EG	7235~8430
EF	7235~7810	FG	7810~8430	GH	8430~9100	GH	8430~9100	GH	8430~9100	GH	8430~9100

■ 80 Series Lumen Bin

Lumen (lm)											
2700K		3000K		4000K		5000K		5700K		6500K	
Bin	Range	Bin	Range	Bin	Range	Bin	Range	Bin	Range	Bin	Range
FG	7810~8430	GH	8430~9100	HI	9100~9820	HI	9100~9820	HI	9100~9820	HI	9100~9820
GI	8430~9820	HJ	9100~10600	IK	9820~11440	IK	9820~11440	IK	9820~11440	IK	9820~11440
IJ	9820~10600	JK	10600~11440	KL	11440~12350	KL	11440~12350	KL	11440~12350	KL	11440~12350

LED HIGH POWER M07 Product Series

■ Forward Voltage Binning Parameter (25decgC)

Parameter	Bin	Symbol	Min	Max	Unit	Condition
Forward Voltage	V1	V_F	33.6	42	V	I_F =Typical current

Note: Full Rank on Label

Example: V1/DF/D1

Forward Voltage Rank	Luminous Flux Rank	Color Rank
V1	CE	D1

LED HIGH POWER M07 Product Series

■ Example of LiteOn CoB MacAdam Ellipse Color Definition (Ex: 3000K)

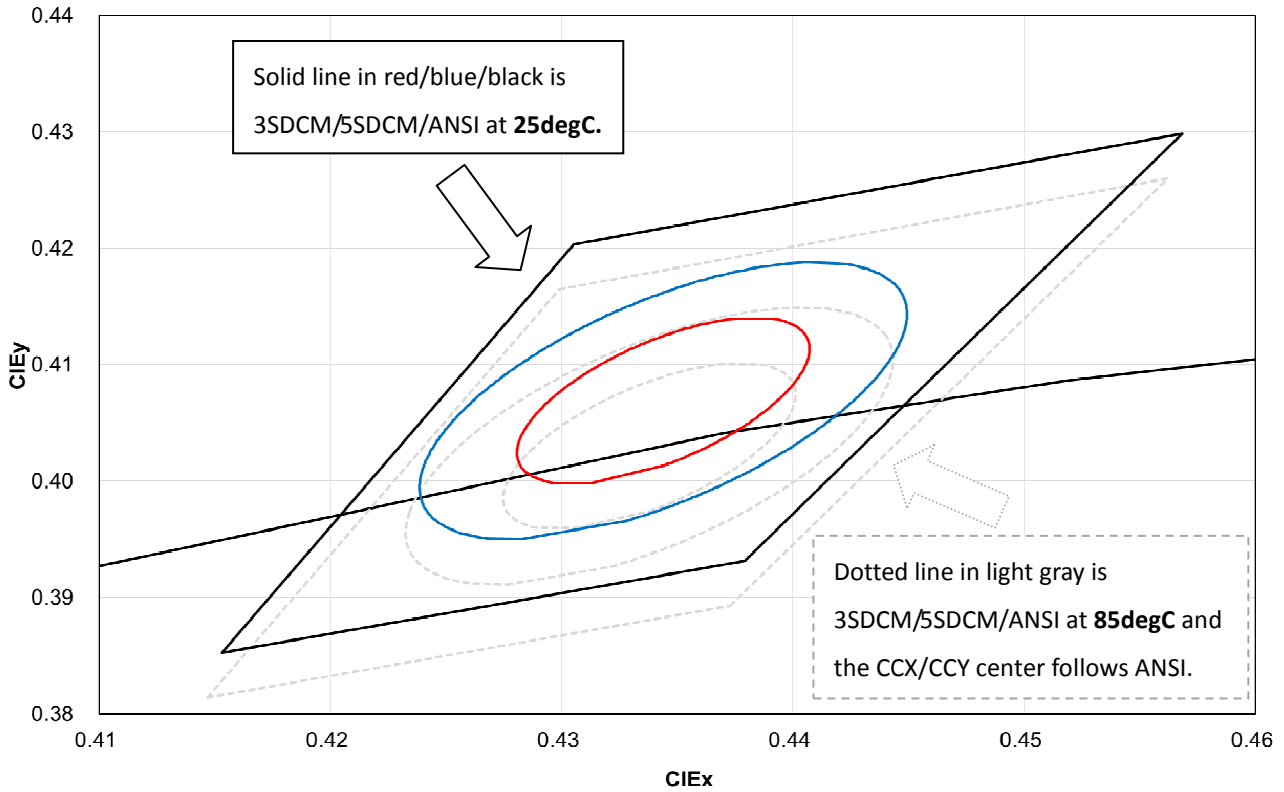

CIE Center Point						
CCT	25degC (LiteOn Spec.)		85degC (ANSI)		Hot/Cold Factor	
	CCX	CCY	CCX	CCY	CCX	CCY
2700	0.4594	0.4147	0.4578	0.4101	-0.0016	-0.0046
3000	0.4369	0.4067	0.4338	0.4030	-0.0031	-0.0037
4000	0.3856	0.3844	0.3818	0.3797	-0.0038	-0.0047
5000	0.3489	0.3603	0.3447	0.3553	-0.0042	-0.0050
5700	0.3322	0.3471	0.3287	0.3417	-0.0035	-0.0054
6500	0.3170	0.3354	0.3123	0.3282	-0.0047	-0.0072

Notes

1. LiteOn tester and shipping spec follow the color bin with 25degC CCX/CCY center.
2. The Hot/Cold factor means the CCX/CCY shift from 25degC to 85degC.
3. The Hot/Cold shift is measured by LiteOn CAS 140B instrument system.
4. The ellipse equation expression: $SDCM = (g11*(x-x_0)^2 + 2*g12*(x-x_0)*(y-y_0) + g22*(y-y_0)^2)^{0.5}$

**LED HIGH POWER
M07 Product Series**

■ M07 CRI80 2700K

PN: LTPL-M074XXZS27-T0

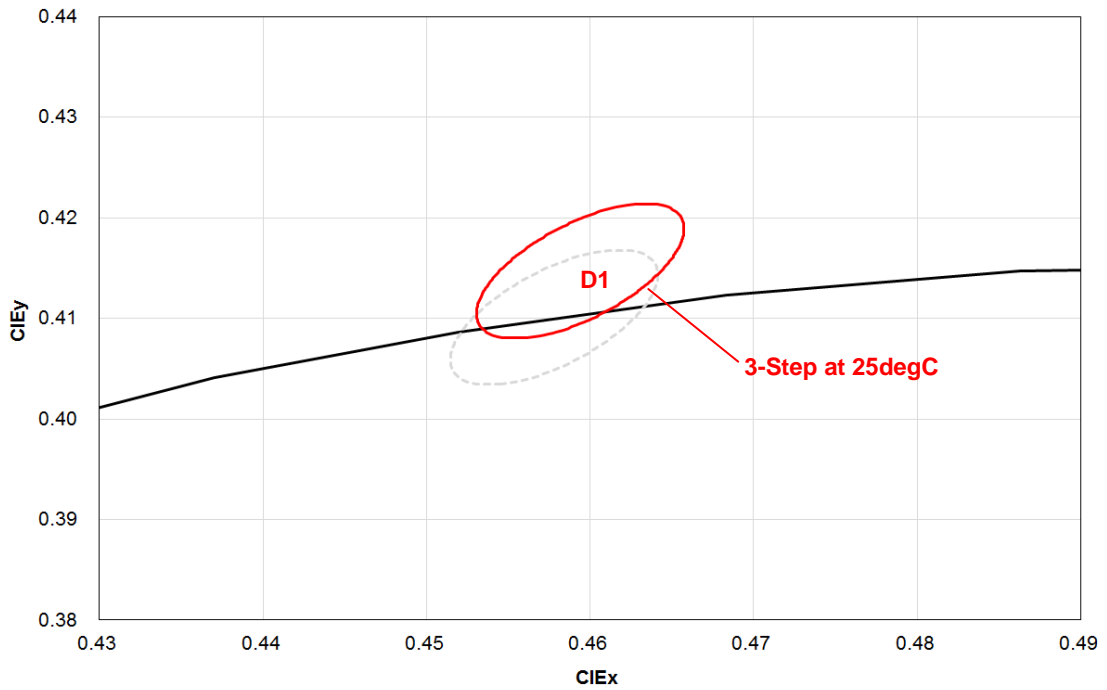

PN: LTPL-M074XXZS27-S1

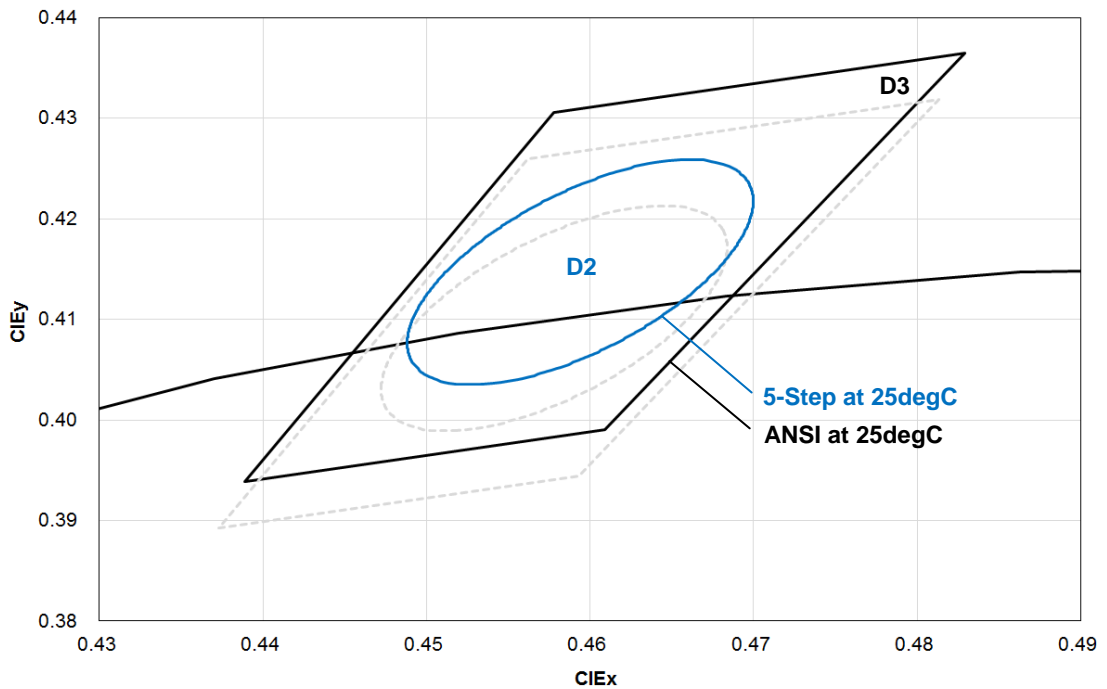

**LED HIGH POWER
M07 Product Series**

■ **M07 CRI80 3000K**

PN: **LTPL-M074XXZS30-T0**

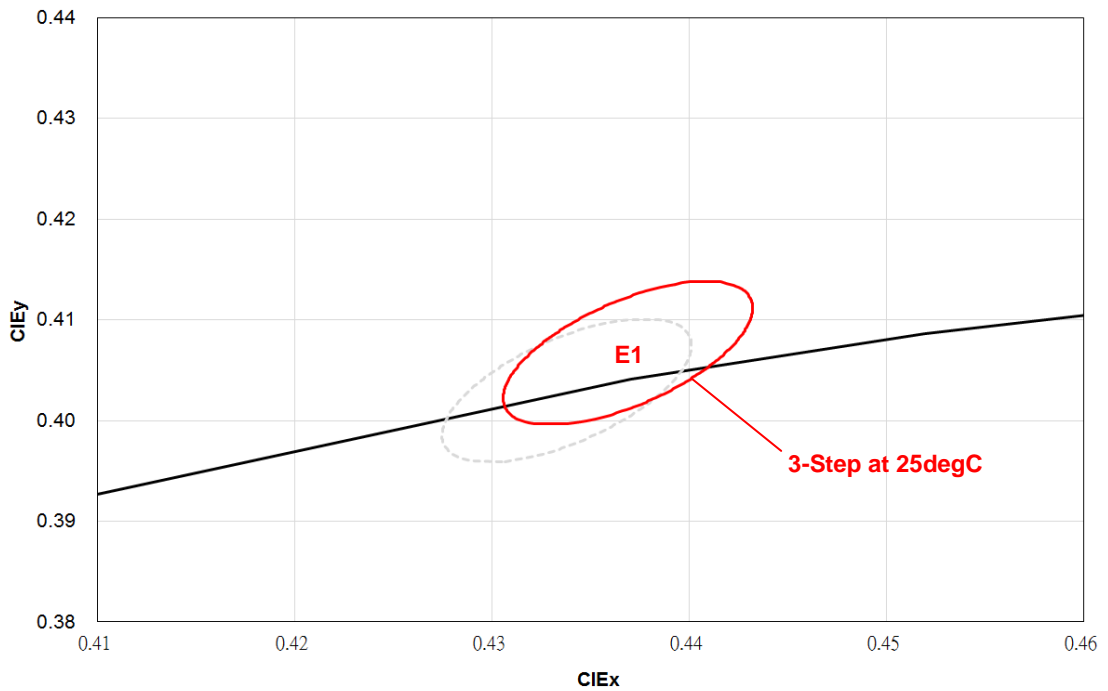

PN: **LTPL-M074XXZS30-S1**

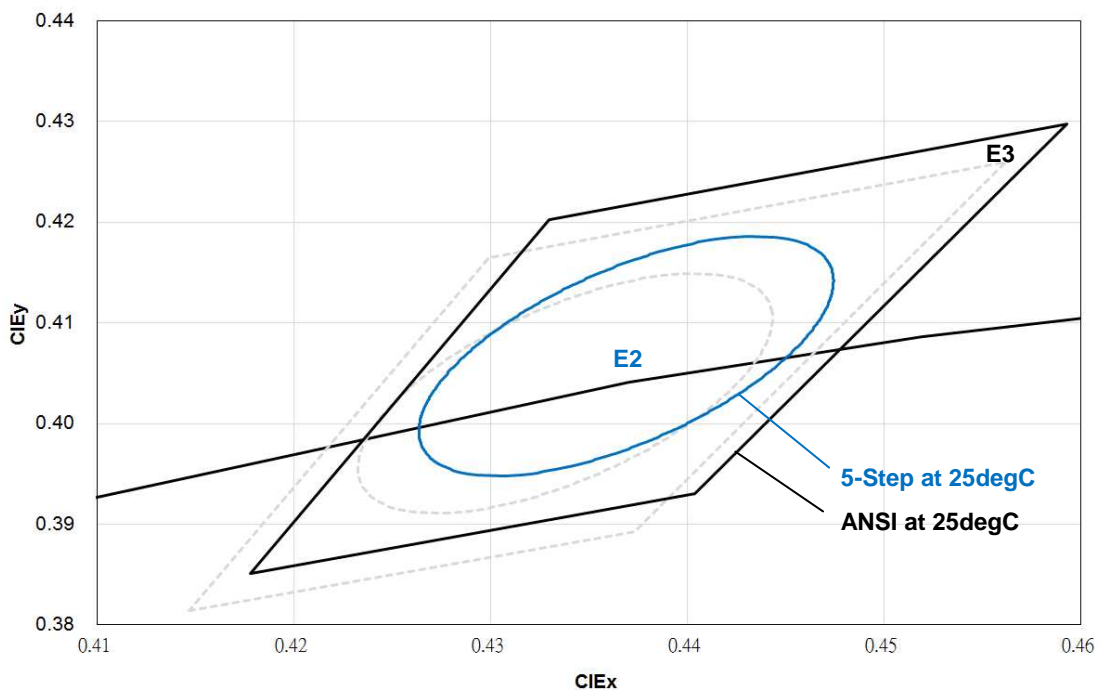

**LED HIGH POWER
M07 Product Series**

■ M07 CRI80 4000K

PN: LTPL-M074XXZS40-T0

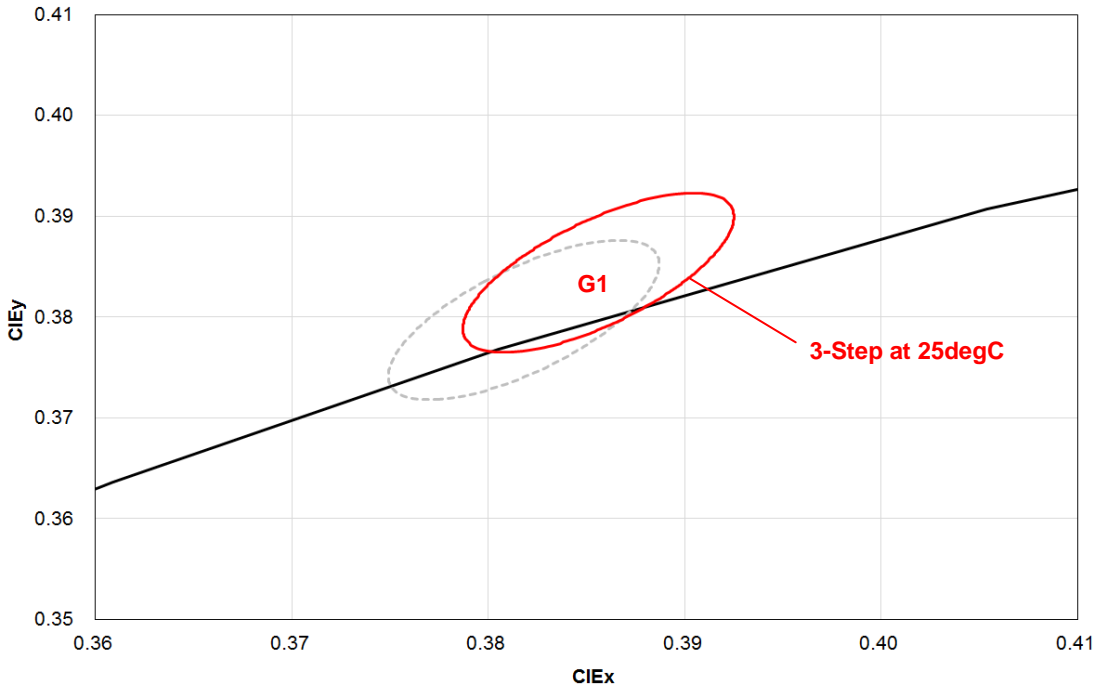

PN: LTPL-M074XXZS40-S1

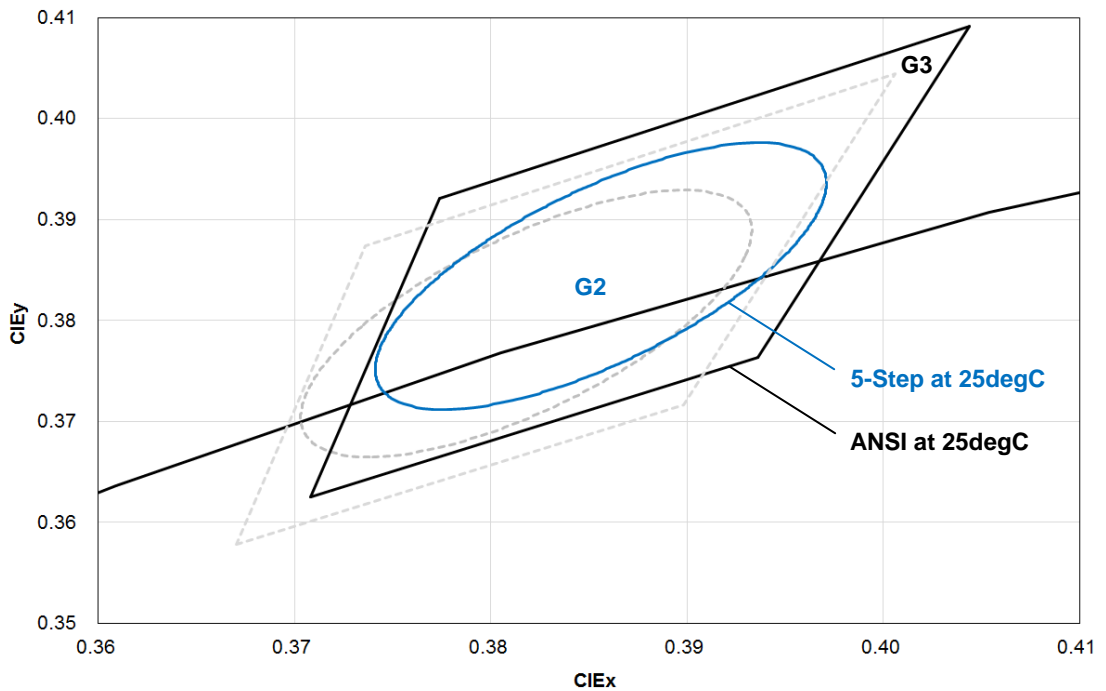

**LED HIGH POWER
M07 Product Series**

■ M07 CRI80 5000K

PN: LTPL-M074XXZS50-F1

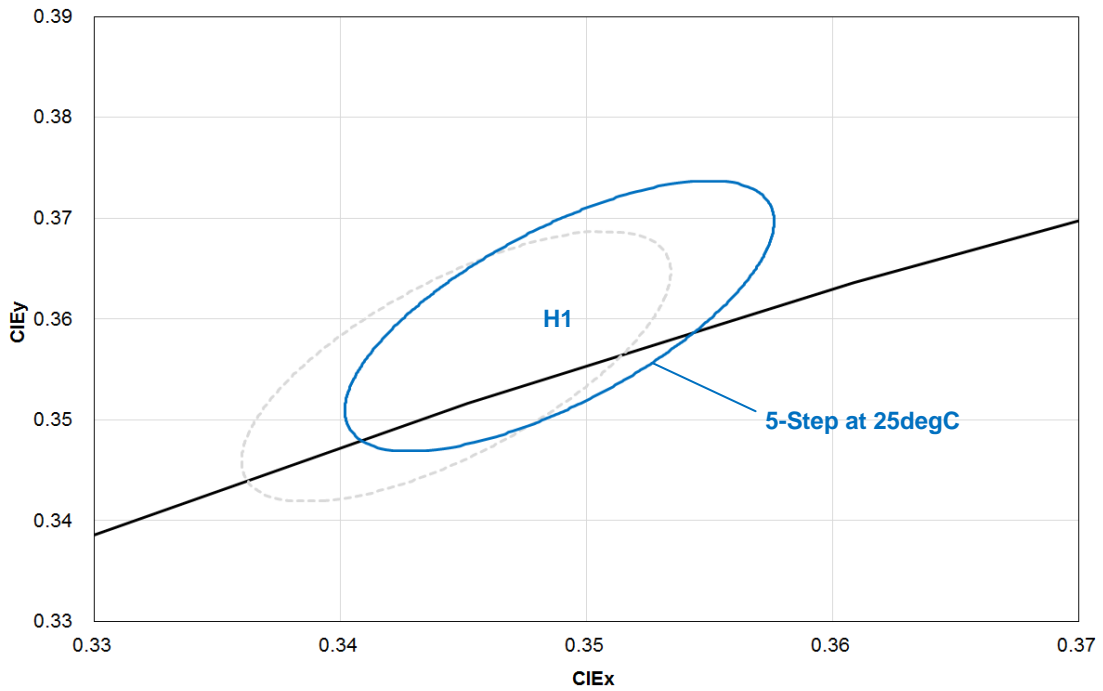

PN: LTPL-M074XXZS50-S1

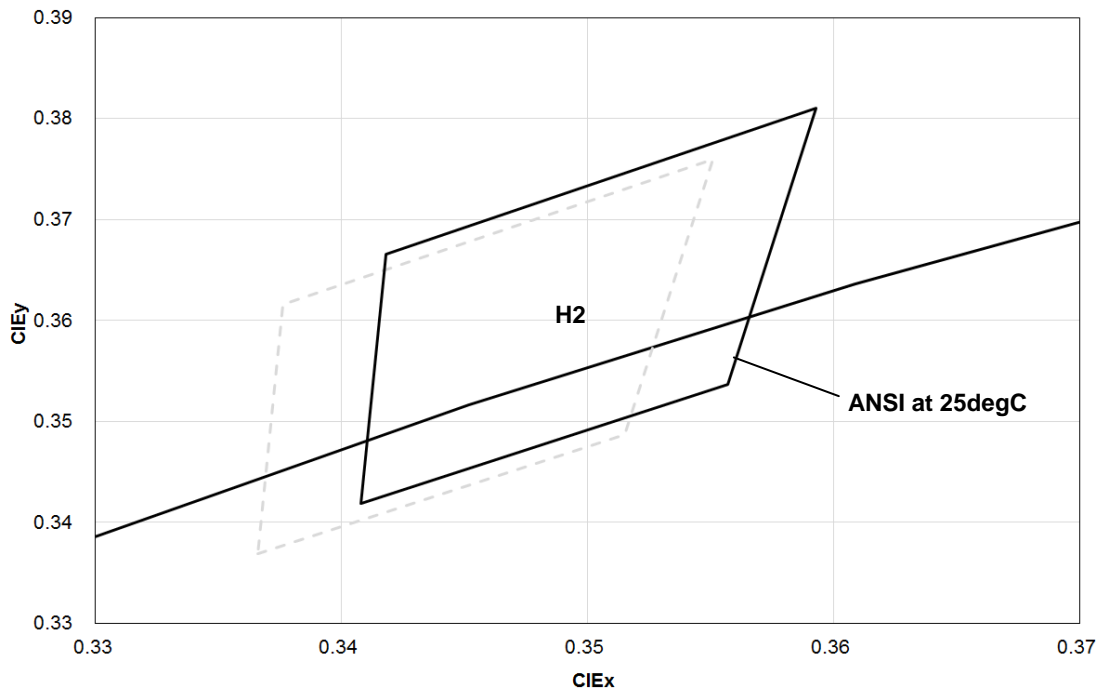

**LED HIGH POWER
M07 Product Series**

■ M07 CRI80 5700K

PN: LTPL-M074XXZS57-F1

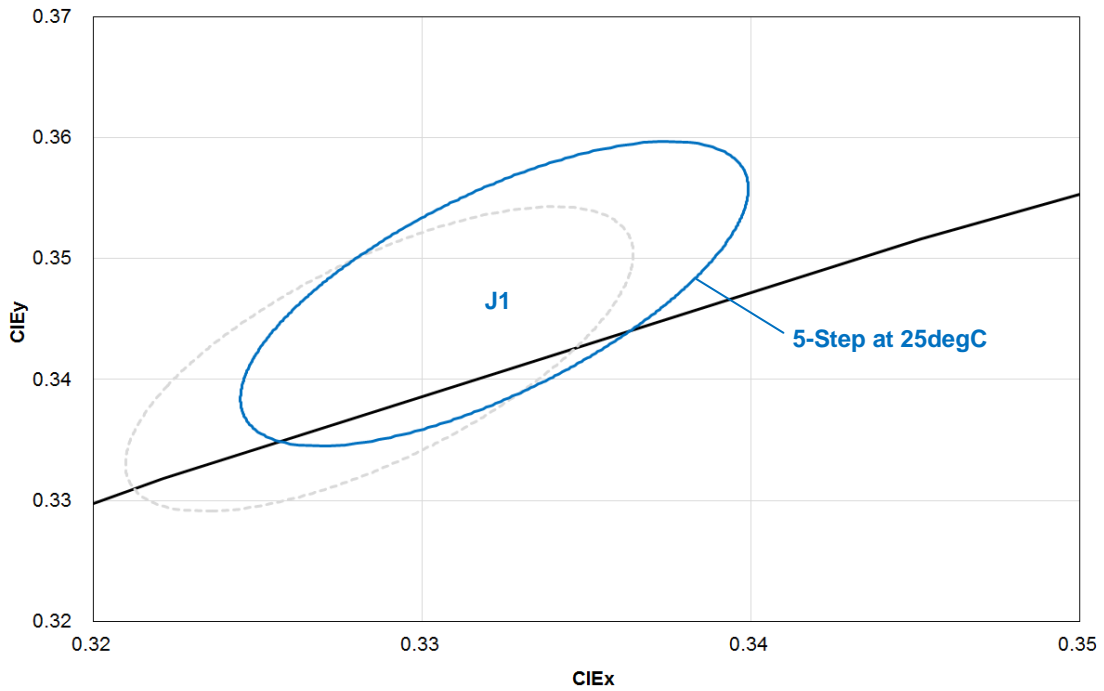

PN: LTPL-M074XXZS57-S1

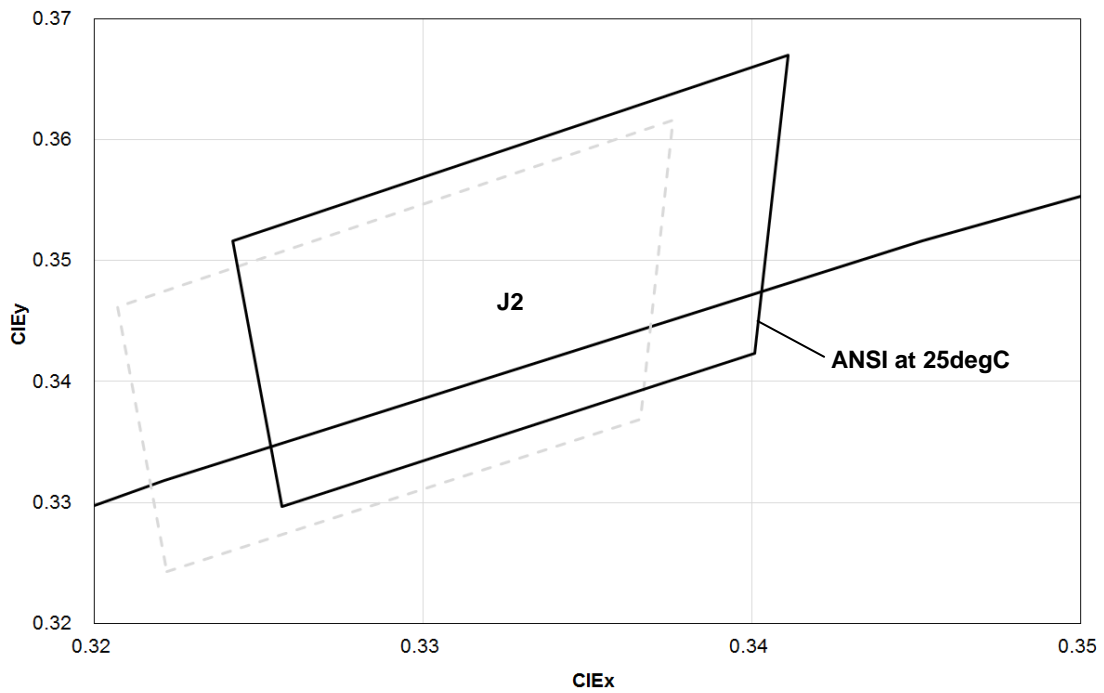

**LED HIGH POWER
M07 Product Series**

■ M07 CRI80 6500K

PN: LTPL-M074XXZS65-F1 t

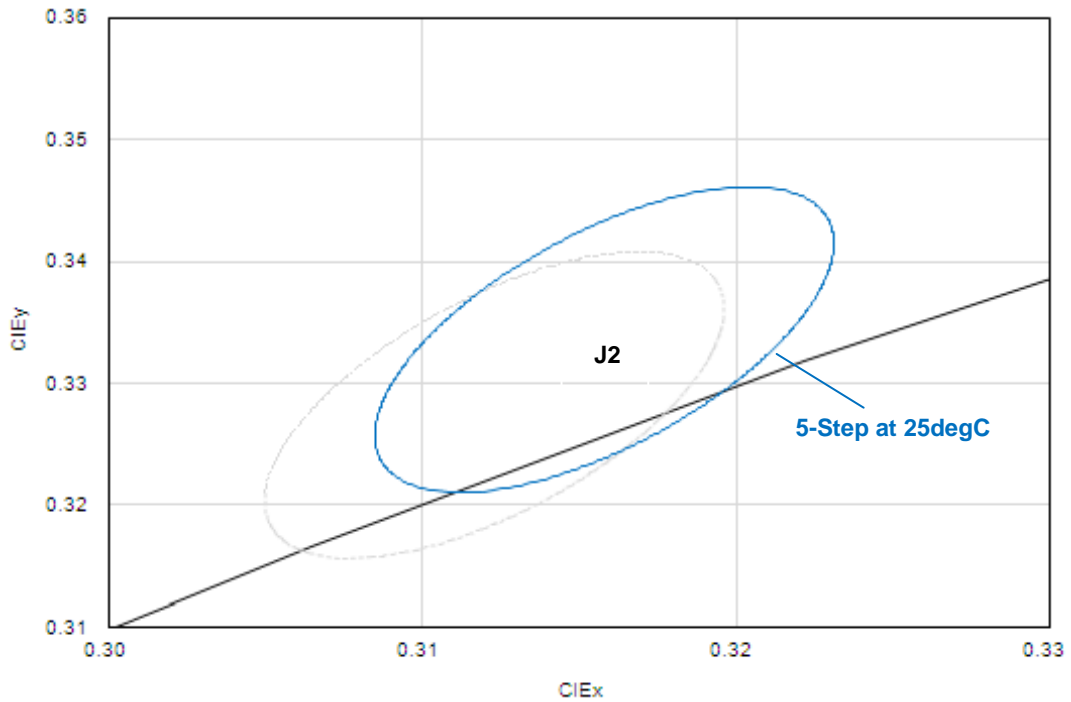

PN: LTPL-M074XXZS65-S1

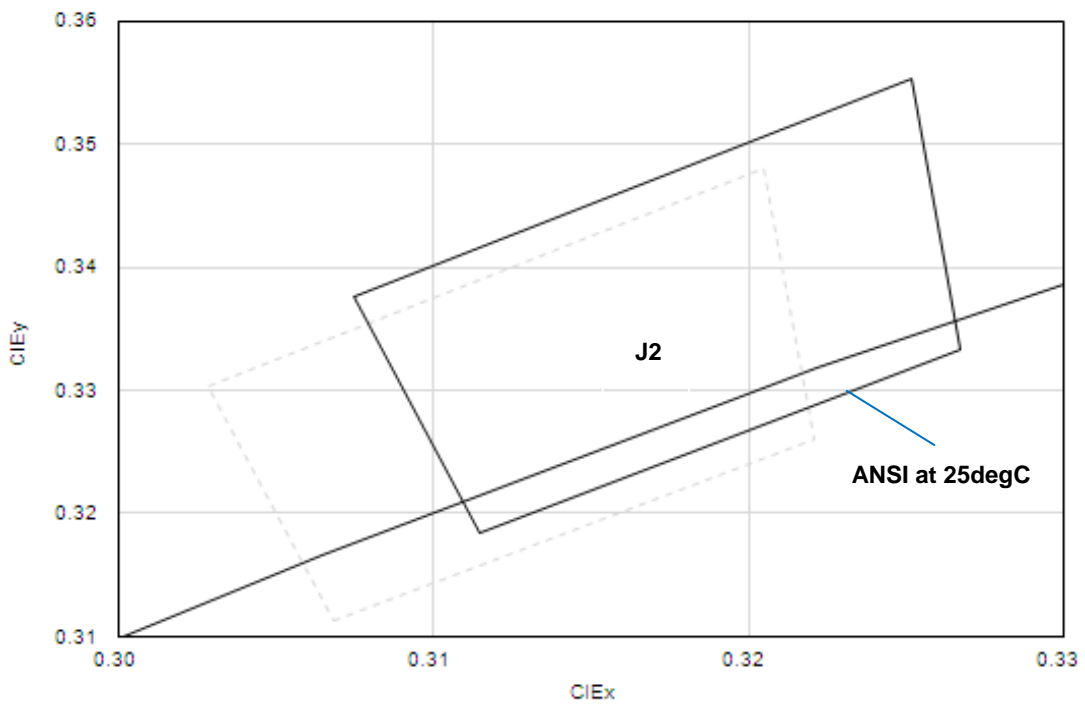

LED HIGH POWER M07 Product Series

6. Reliability Test Plan

No	Test item	Condition	Duration	Number of Failed	Result
1	High Temperature Operating Life	$T_c=85^{\circ}\text{C}$, I_F =Typical Current	1K hours	0/10	Pass
2	Wet High Temperature Operating Life	$60^{\circ}\text{C}/90\%\text{RH}$, I_F =Typical Current(DC) 30 mins ON/OFF	1K hours	0/10	Pass
3	Thermal Shock	-40°C to 125°C , 15minutes dwell, <10 seconds transfer, measurement in every 250 cycles	500 cycles	0/10	Pass
4	Fast Switch Cycling Test	40000cycles, 2 mins On/Off, Room temperature($25^{\circ}\text{C}\pm 5^{\circ}\text{C}$), measurement in every 5000 cycles	40K cycles	0/10	Pass
5	High Temperature Storage Life	$T_a=120^{\circ}\text{C}$	1K hours	0/10	Pass
6	Low Temperature Storage Life	$T_a=-55^{\circ}\text{C}$	1K hours	0/10	Pass
7	Mechanical Shock	1500G, 0.5ms pulse, 5 shocks each 6 axis	30 Times (5 shocks each 6 axis)	0/10	Pass
8	Variable Vibration Frequency	10-2000-10 Hz, log or linear sweep rate, 20G for approximately minute 1.5mm, each applied three times per axis over 6 hrs.	18 hrs (3 times per axis over 6 hrs)	0/10	Pass

■ Criteria for Judging the Damage

Item	Symbol	Test Condition	Criteria for Judgment	
			Min.	Max.
Forward Voltage	V_F	I_F =Typical Current		U.S.L. x 1.1
Luminous Flux	Lm	I_F =Typical Current	L.S.L. x 0.7	
CCX & CCY	X,Y	I_F =Typical Current		Shift<0.02

Notes

1. Operating life tests are mounted on thermal heat sink
2. Storage items are only component, not put on heat sink.

LED HIGH POWER M07 Product Series

7. Packing Specifications

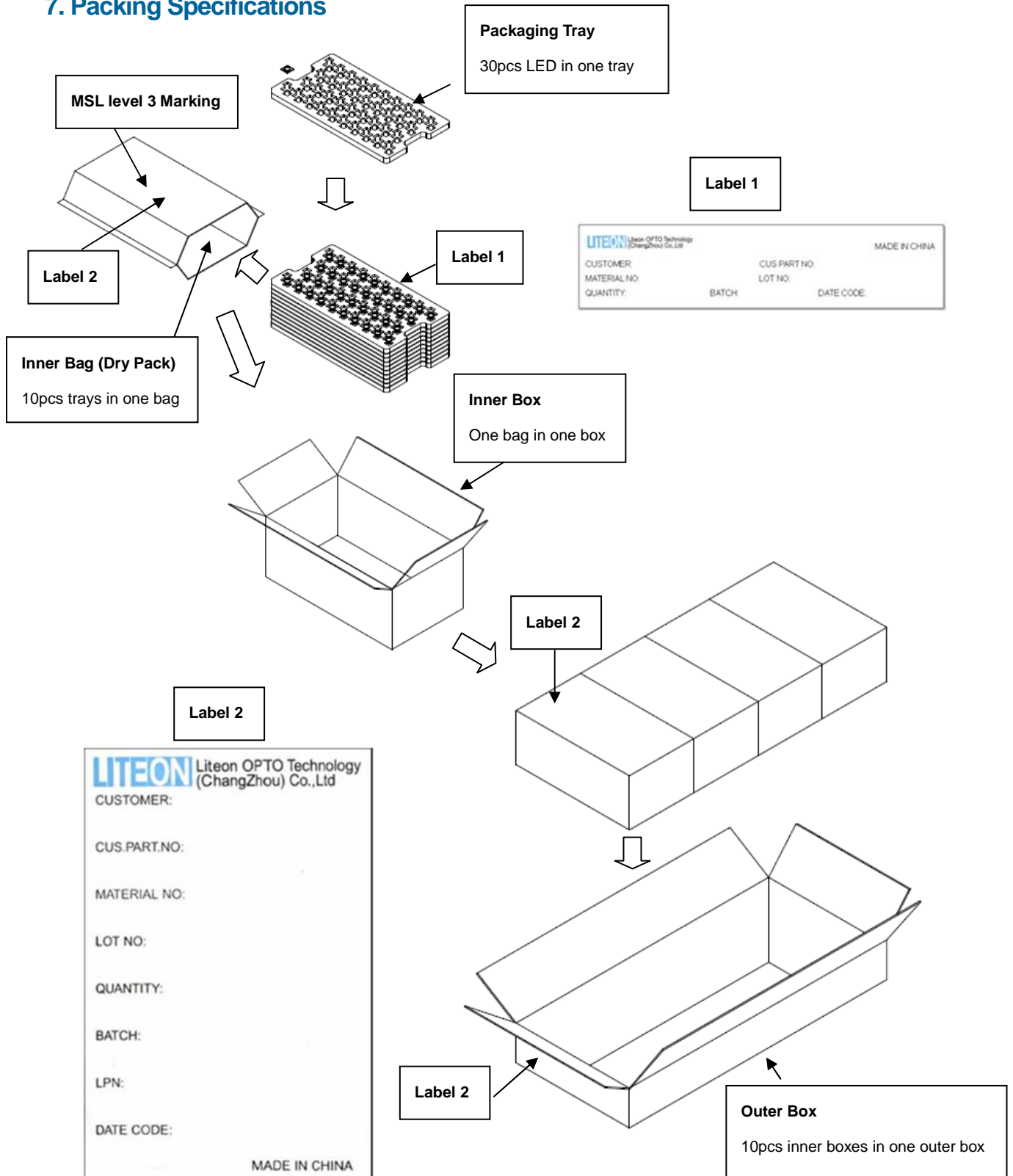

LED HIGH POWER M07 Product Series

8. Cautions

8.1 An LED is a current-operated device. In order to ensure intensity uniformity on multiple LEDs connected in parallel in an application, it is recommended that a current limiting resistor be incorporated in the drive circuit, in series with each LED as shown in circuit below.

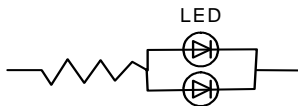

(A) Recommended circuit.

(B) The brightness of each LED might appear different due to the differences in the I-V characteristics of those LEDs.

8.2 Do not put any pressure on the light emitting surface either by finger or any hand tool and do not stack the COB products. Stress or pressure may cause damage to the wires of the LED array.

8.3 This product is not designed for the use under any of the following conditions, please confirm the performance and reliability are well enough if you use it under any of the following conditions

- Do not use sulfur-containing materials in commercial products including the materials such as seals and adhesives that may contain sulfur.
- Do not put this product in a place with a lot of moisture (over 85% relative humidity), dew condensation, briny air, and corrosive gas (Cl, H₂S, NH₃, SO₂, NO_x, etc.), exposure to a corrosive environment may affect silver plating.

ESD (Electrostatic Discharge)

Static Electricity or power surge will damage the LED. Suggestions to prevent ESD damage:

- Use of a conductive wrist band or anti-electrostatic glove when handling these LEDs.
- All devices, equipment, and machinery must be properly grounded.
- Work tables, storage racks, etc. should be properly grounded.
- Use ion blower to neutralize the static charge which might have built up on surface of the LED's plastic lens as a result of friction between LEDs during storage and handling.

ESD-damaged LEDs will exhibit abnormal characteristics such as high reverse leakage current, low forward voltage, or “no light up” at low currents.

To verify for ESD damage, check for “light up” and V_F of the suspect LEDs at low currents.