

Part Number: KPG-0603SEC-E-TT Hyper-Red

Features

- 0.65mmX0.35mm SMT LED,0.2mm thickness.
- Low power consumption.
- Wide viewing angle.
- Compatible with automatic placement equipment.
- Package:4000pcs/reel.
- Moisture sensitivity level : level 2.
- RoHS compliant.

Description

The Hyper-Red source color devices are made with Al-GaNp on GaAs substrate Light Emitting Diode.

Package Dimensions

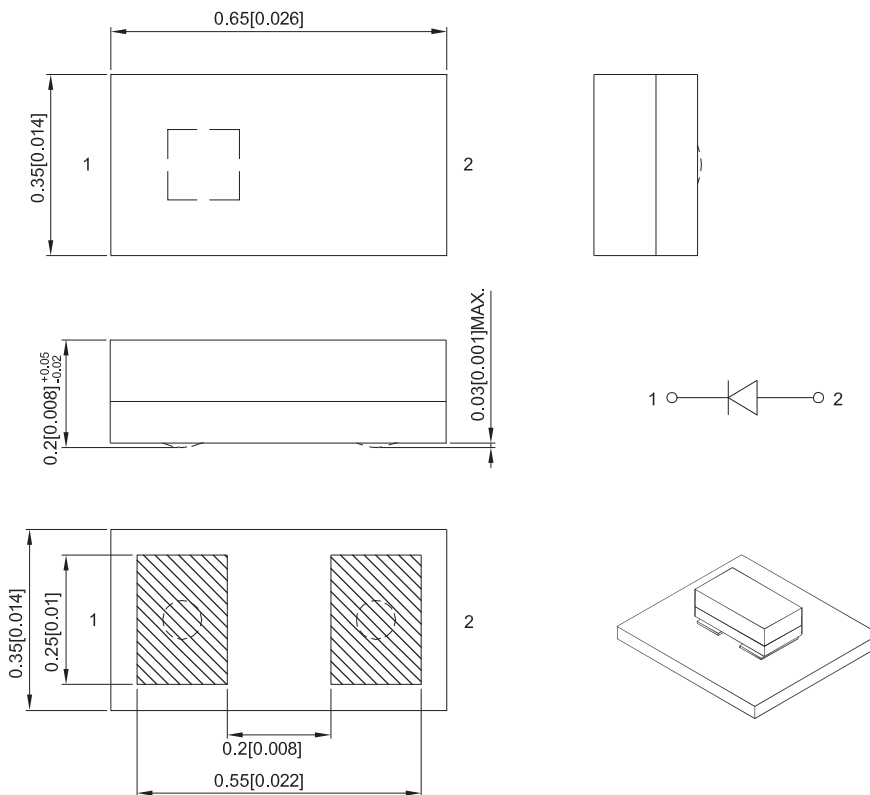

Notes:

1. All dimensions are in millimeters (inches).
2. Tolerance is ± 0.1 (0.004") unless otherwise noted.
3. The specifications, characteristics and technical data described in the datasheet are subject to change without prior notice.
4. The device has a single mounting surface. The device must be mounted according to the specifications.



Selection Guide

Part No.	Dice	Lens Type	Iv (mcd) [2] @ 10mA		Viewing Angle [1]
			Min.	Typ.	2θ1/2
KPG-0603SEC-E-TT	Hyper-Red(AlGaInp)	Water Clear	45	120	135°
			*15	*40	

Notes:

1. θ1/2 is the angle from optical centerline where the luminous intensity is 1/2 of the optical peak value.
2. Luminous intensity/ luminous Flux: +/-15%.
- *Luminous intensity value is traceable to the CIE127-2007 compliant national standards.

Electrical / Optical Characteristics at TA=25°C

Symbol	Parameter	Device	Typ.	Max.	Units	Test Conditions
λpeak	Peak Wavelength	Hyper-Red	632		nm	IF=10mA
λD [1]	Dominant Wavelength	Hyper-Red	624		nm	IF=10mA
Δλ1/2	Spectral Line Half-width	Hyper-Red	20		nm	IF=10mA
VF [2]	Forward Voltage	Hyper-Red	1.94	2.4	V	IF=10mA
IR	Reverse Current	Hyper-Red		10	uA	VR=5V

Notes:

1. Wavelength: +/-1nm.
2. Forward Voltage: +/-0.1V.
3. Wavelength value is traceable to the CIE127-2007 compliant national standards.
4. Excess driving current and/or operating temperature higher than recommended conditions may result in severe light degradation or premature failure.

Absolute Maximum Ratings at TA=25°C

Parameter	Hyper-Red	Units
Power dissipation	48	mW
DC Forward Current	20	mA
Peak Forward Current [1]	100	mA
Reverse Voltage	5	V
Operating Temperature	-40°C To +85°C	
Storage Temperature	-40°C To +85°C	

Note:

1. 1/10 Duty Cycle, 0.1ms Pulse Width.

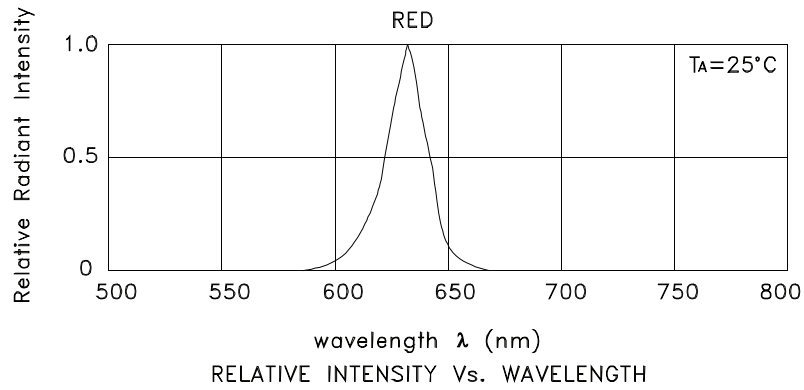

Hyper-Red

KPG-0603SEC-E-TT

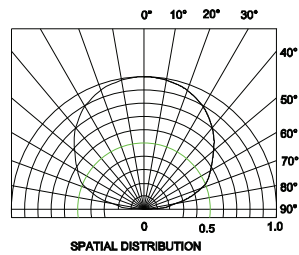
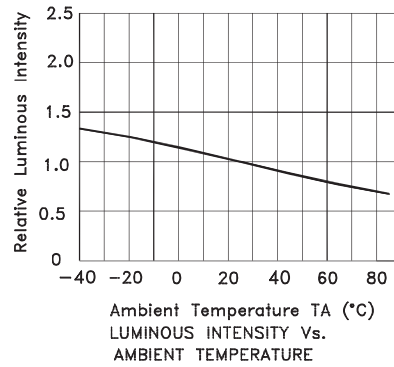
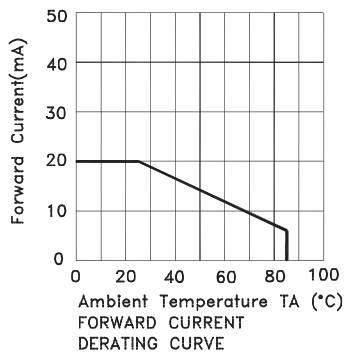
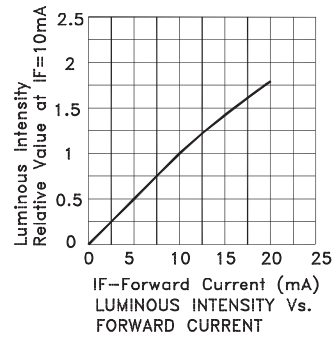
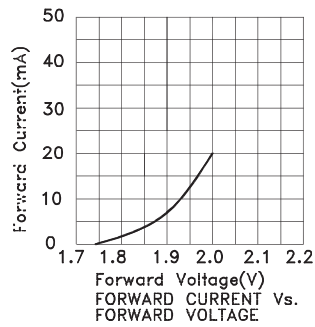

KPG-0603SEC-E-TT

Reflow soldering is recommended and the soldering profile is shown below.
Other soldering methods are not recommended as they might cause damage to the product.

Reflow Soldering Profile For Lead-free SMT Process.

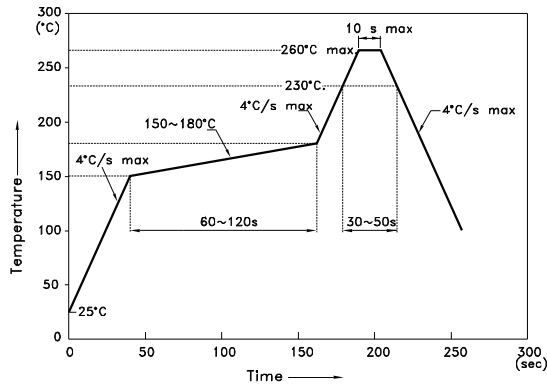

NOTES:

1. We recommend the reflow temperature 245°C(+/-5°C). The maximum soldering temperature should be limited to 260°C.
2. Don't cause stress to the epoxy resin while it is exposed to high temperature.
3. Number of reflow process shall be 2 times or less.

Recommended Soldering Pattern (Units : mm; Tolerance: ± 0.1)

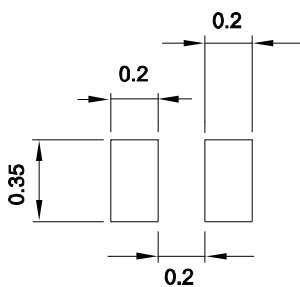

Reel Dimension

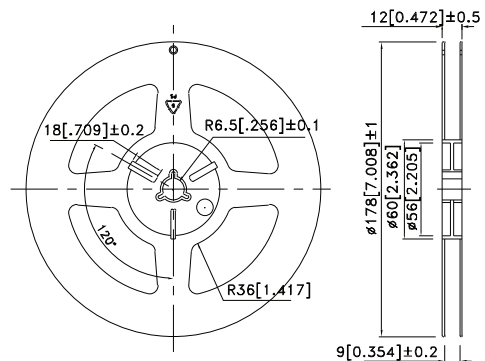

Tape Dimensions (Units : mm)

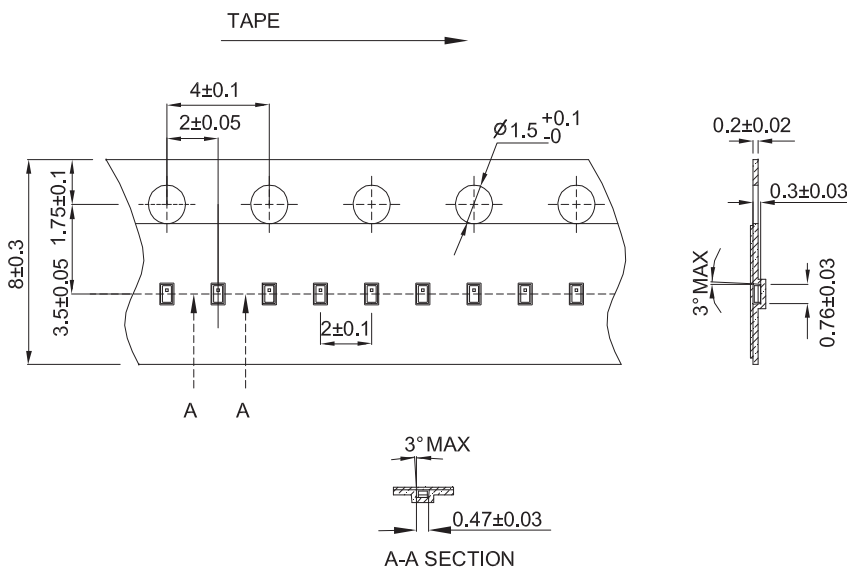

PACKING & LABEL SPECIFICATIONS

KPG-0603SEC-E-TT

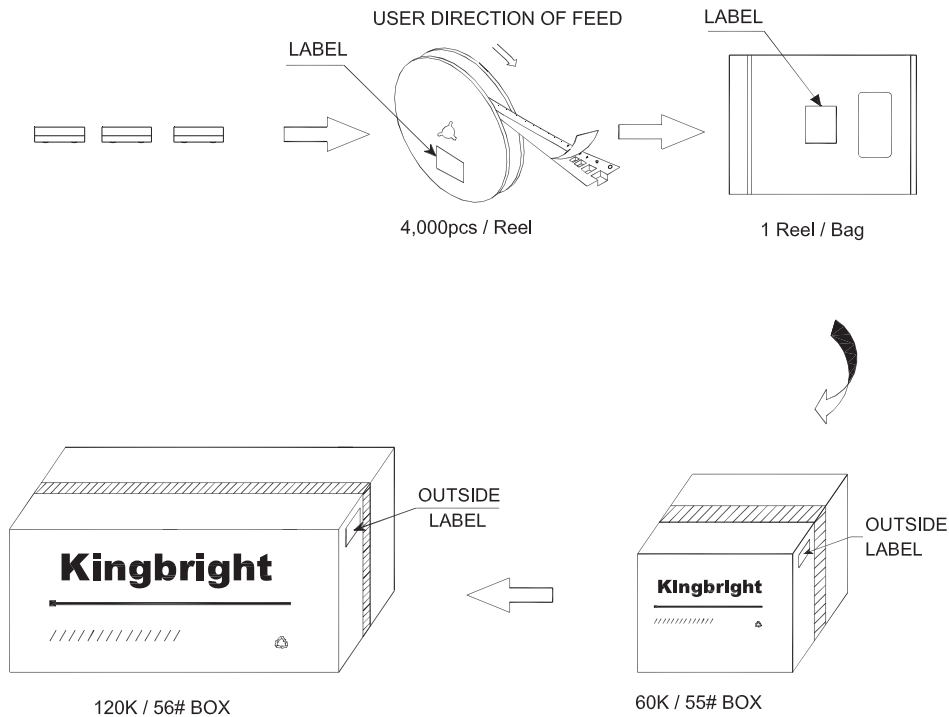

<h1>Kingbright</h1>							
P/NO: KPG-0603xxx							
QTY: 4000 pcs	Q.C.						
S/N: XXXX	<table border="1"> <tr> <td>Q</td> <td>C</td> </tr> <tr> <td>xx</td> <td>xx xxxx</td> </tr> <tr> <td colspan="2" style="text-align: center;">PASSED</td> </tr> </table>	Q	C	xx	xx xxxx	PASSED	
Q	C						
xx	xx xxxx						
PASSED							
CODE: XXX							
LOT NO:							
 xxxxxxxxxxxxxxxxxxxxxxxxxxxx							
RoHS Compliant							

Terms and conditions for the usage of this document

1. The information included in this document reflects representative usage scenarios and is intended for technical reference only.
2. The part number, type, and specifications mentioned in this document are subject to future change and improvement without notice. Before production usage customer should refer to the latest datasheet for the updated specifications.
3. When using the products referenced in this document, please make sure the product is being operated within the environmental and electrical limits specified in the datasheet. If customer usage exceeds the specified limits, Kingbright will not be responsible for any subsequent issues.
4. The information in this document applies to typical usage in consumer electronics applications. If customer's application has special reliability requirements or have life-threatening liabilities, such as automotive or medical usage, please consult with Kingbright representative for further assistance.
5. The contents and information of this document may not be reproduced or re-transmitted without permission by Kingbright.
6. All design applications should refer to Kingbright application notes available at http://www.kingbright.com/application_notes