

PROVEN PERFORMANCE

Customers in over 50 countries and in diverse markets and sectors.



Kinco

Motion Control
Servo System

Servo System Catalog

- JD/FD2S/CD2S Series Servo Driver
- Servo Motor



Kinco® Automation
www.en.kinco.cn Email:sales@kinco.cn

(All trademarks and logos in this brochure are property of and registered by their respective owners.)

K1E05-1605

02 Model Description of Servo Driver and Motor

- Kinco JD Series Servo Driver
- Kinco FD2S Series Servo Driver
- Kinco CD2S Series Servo Driver
- Kinco Servo Motor
- Kinco Multi-pole Servo Motor
- Power, Brake, Encoder cable of Motor

04 Servo Driver and Motor Selection Table

- JD/FD2S/CD2S Servo Driver and Motor Selection Table (1)
- JD/FD2S/CD2S Servo Driver and Motor Selection Table (2)
- FD2S/CD2S Servo Driver and Motor Selection Table

07 Servo Driver Introduction

Panel and Interface Description, Port Description, Technical Specifications, Wiring Diagram, Mechanical Dimension Diagram

- JD Servo Driver
- FD2S Servo Driver
- FD122 Servo Driver
- CD2S Servo Driver

23 Servo Motor Introduction

- Technical Specifications Table of SMH Series Servo Motor (40/60/80 flange)
- Technical Specifications Table of SMH Series Servo Motor (110 flange)
- Technical Specifications Table of SMH Series Servo Motor (130/150 flange)
- Technical Specifications Table of SMH Series Servo Motor (180 flange)
- Technical Specifications Table of Low-voltage Series Servo Motor (40/60/80 flange)
- Technical Specifications Table of Multi-pole Servo Motor (57/85 flange)
- Technical Specifications Table of SMC Series Servo Motor (60/80 flange)
- Technical Specifications Table of SMC Series Servo Motor (130 flange)
- Technical Specifications Table of SMS Series Servo Motor (60/80 flange)

- Dimension/Torque curve of SMH Series Servo Motor
- Dimension/Torque curve of Low-voltage Series Servo Motor
- Dimension/Torque curve of Multi-pole Servo Motor
- Dimension/Torque curve of SMC Series Servo Motor
- Dimension/Torque curve of SMS Series Servo Motor

39 Wiring Diagram for Cable

- Wiring Diagram for The Power Cable
- Wiring Diagram for The Encoder Cable

Model Description of Servo Driver and Motor

Kinco JD Series Servo Driver

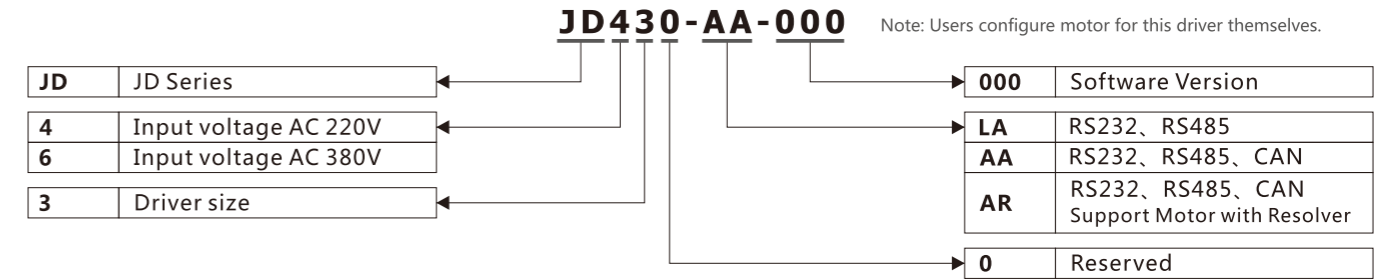

Kinco FD2S Series Servo Driver

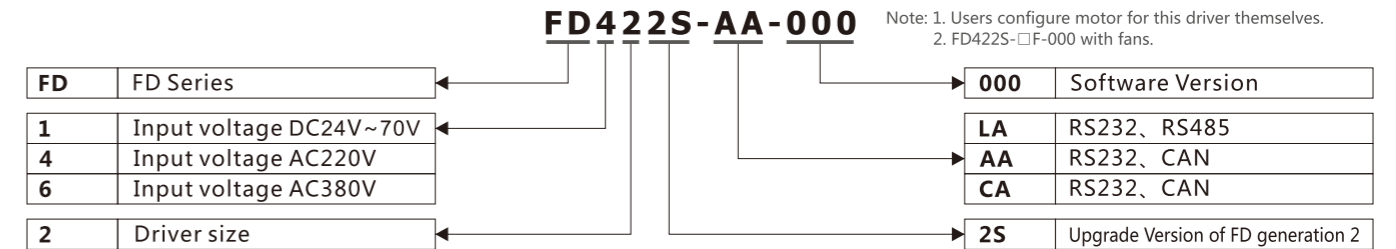

Kinco CD2S Series Servo Driver

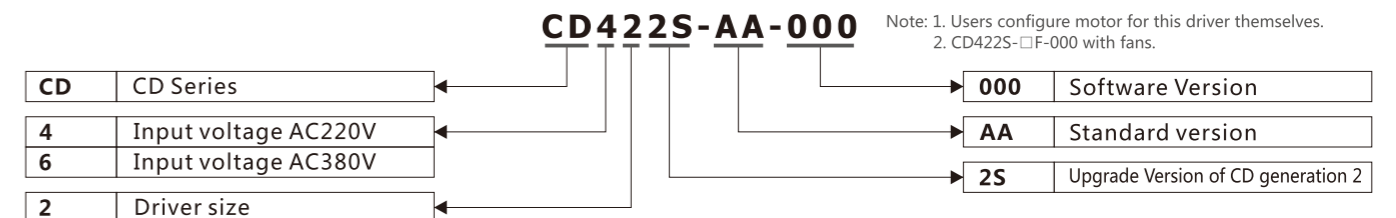

Kinco Servo Motor

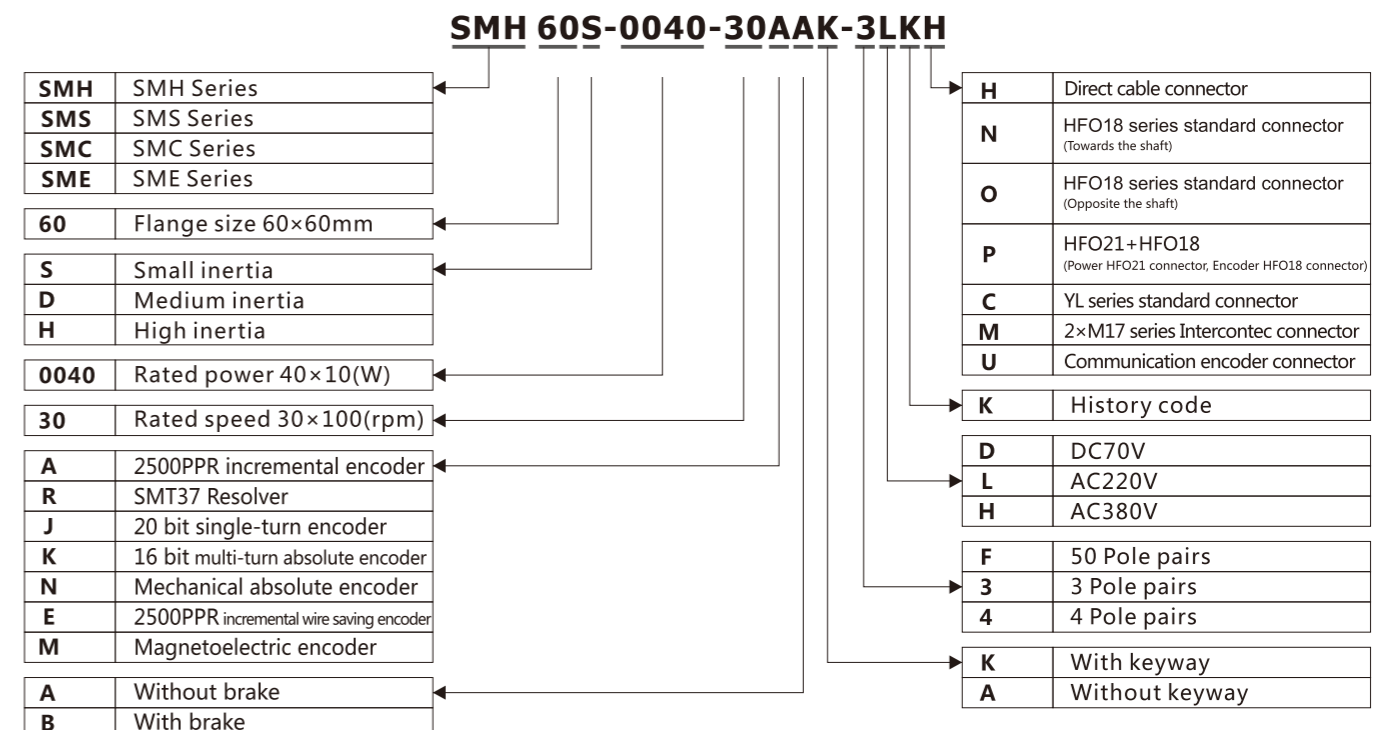

20 bit single-turn encoder and 16 bit multi-turn absolute encoder are a kind of communication encoder.

Kinco Multi-pole Servo Motor

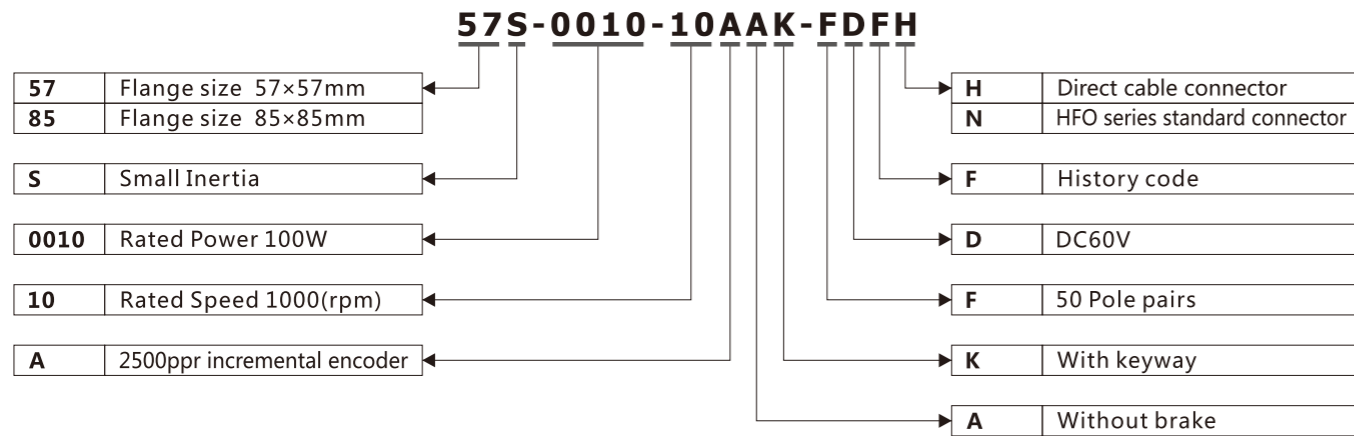

Model Description of Cable

Power, Brake and Encoder Cable of Motors

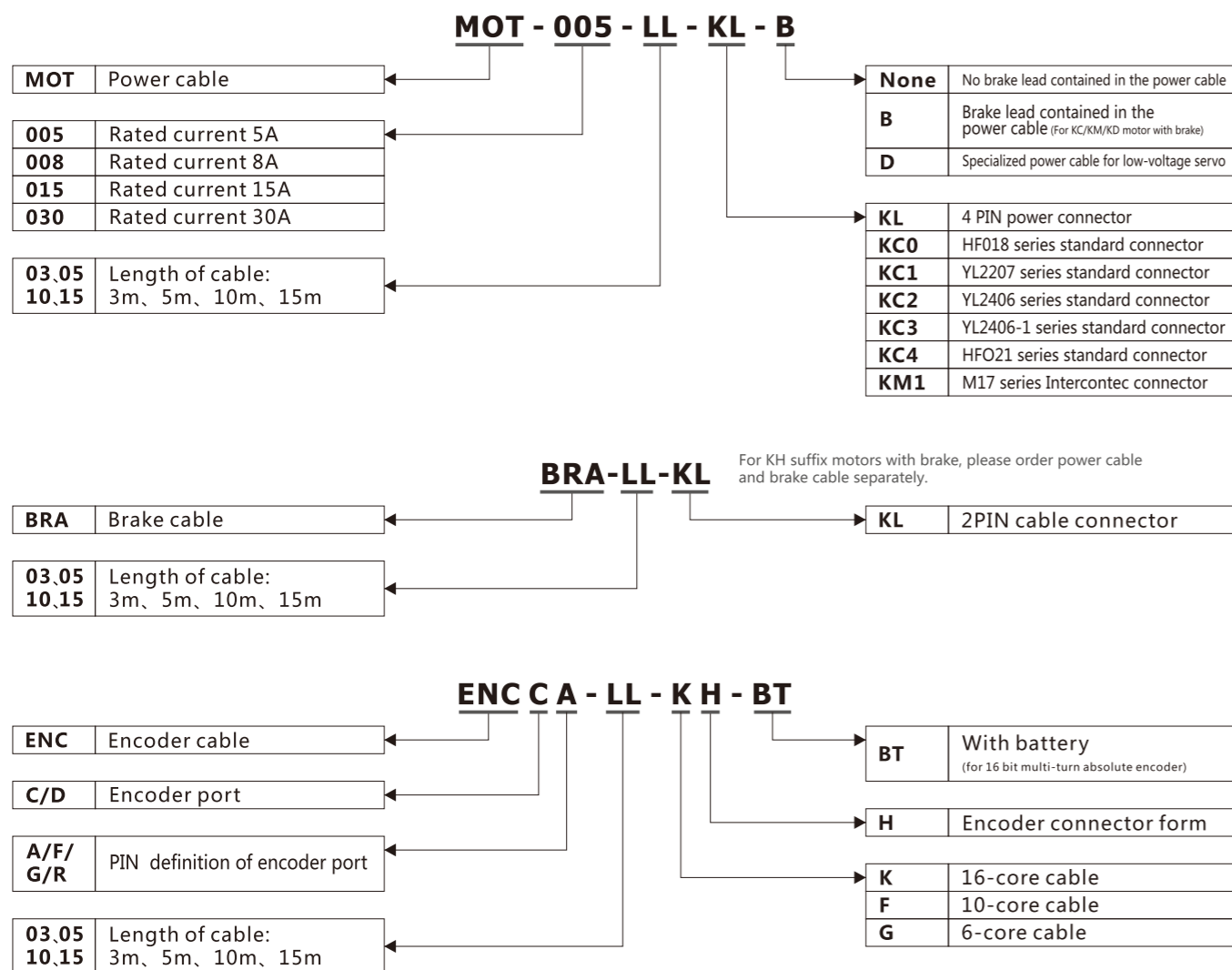

JD/FD2S/CD2S Servo Driver and Motor Selection Table (1)

Category	Rated Power/ Rated Speed/ Rated Torque	Servo Motor	Description	Power/ Brake Cable	Encoder Cable	Servo Driver	
Small Inertia 220V	50W 3000rpm/0.16Nm	SMH40S-0005-30AAK-4LKH	2500P/R Cable connector	MOT-005-LL-KL	ENCCA-LL-KH	FD412S-CA-000 FD412S-AA-000 FD412S-LA-000 CD412S-AA-000	
		SMH40S-0005-30ABK-4LKH	2500P/R Cable connector with brake	MOT-005-LL-KL/BRA-LL-KL			
	100W 3000rpm/0.32Nm	SMH40S-0010-30AAK-4LKH	2500P/R Cable connector	MOT-005-LL-KL			
		SMH40S-0010-30ABK-4LKH	2500P/R Cable connector with brake	MOT-005-LL-KL/BRA-LL-KL			
	200W 3000rpm/0.64Nm	SMH60S-0020-30AAK-3LKH	2500P/R Cable connector	MOT-005-LL-KL			ENCCA-LL-KC0
		SMH60S-0020-30ABK-3LKH	2500P/R Cable connector with brake	MOT-005-LL-KL/BRA-LL-KL			
		SMH60S-0020-30AAK-3LKN	2500P/R HFO18 series standard connector	MOT-005-LL-KC0			
		SMH60S-0020-30ABK-3LKP	2500P/R HFO18+HFO21 connector with brake	MOT-005-LL-KC4-B	ENCCA-LL-KM1		
		SMH60S-0020-30AAK-3LKO	2500P/R HFO18 series standard connector	MOT-005-LL-KC0			
		SMH60S-0020-30AAK-3LKM	2500P/R Intercontec connector	MOT-005-LL-KM1			
	400W 3000rpm/1.27Nm	SMH60S-0040-30AAK-3LKH	2500P/R Cable connector	MOT-005-LL-KL	ENCCA-LL-KH		
		SMH60S-0040-30ABK-3LKH	2500P/R Cable connector with brake	MOT-005-LL-KL/BRA-LL-KL			
		SMH60S-0040-30AAK-3LKN	2500P/R HFO18 series standard connector	MOT-005-LL-KC0			
		SMH60S-0040-30ABK-3LKP	2500P/R HFO18+HFO21 connector with brake	MOT-005-LL-KC4-B	ENCCA-LL-KC0		
		SMH60S-0040-30AAK-3LKO	2500P/R HFO18 series standard connector	MOT-005-LL-KC0			
		SMH60S-0040-30AAK-3LKM	2500P/R Intercontec connector	MOT-005-LL-KM1			
	750W 3000rpm/2.39Nm	SMH80S-0075-30AAK-3LKH	2500P/R Cable connector	MOT-005-LL-KL	ENCCA-LL-KH		
		SMH80S-0075-30ABK-3LKH	2500P/R Cable connector with brake	MOT-005-LL-KL/BRA-LL-KL			
		SMH80S-0075-30AAK-3LKN	2500P/R HFO18 series standard connector	MOT-005-LL-KC0			
		SMH80S-0075-30ABK-3LKP	2500P/R HFO18+HFO21 connector with brake	MOT-005-LL-KC4-B	ENCCA-LL-KC0		
		SMH80S-0075-30AAK-3LKO	2500P/R HFO18 series standard connector	MOT-005-LL-KC0			
		SMH80S-0075-30AAK-3LKM	2500P/R Intercontec connector	MOT-005-LL-KM1			
	4.18Nm 6Nm 7.5Nm	85S-0025-05AAK-FLFN-02	2500P/R Multi-pole servo motor	MOTE-005-LL-KC0	ENCCF-LL-FC0		
		85S-0035-05AAK-FLFN-02	2500P/R Multi-pole servo motor				
85S-0045-05AAK-FLFN-02		2500P/R Multi-pole servo motor					
1kW 3000rpm/3.18Nm	SMH80S-0100-30AAK-3LKH	2500P/R Cable connector	MOT-008-LL-KL	ENCCA-LL-KH			
	SMH80S-0100-30ABK-3LKH	2500P/R Cable connector with brake	MOT-008-LL-KL/BRA-LL-KL				
	SMH80S-0100-30AAK-3LKM	2500P/R Intercontec connector	MOT-008-LL-KM1				
Medium Inertia 220V	1.05kW 2000rpm/5Nm	SMH110D-0105-20AAK-4LKC	2500P/R HFO18 series standard connector	MOT-008-LL-KC1	ENCCA-LL-KC1	JD430-AA-000 FD432S-CA-000 FD432S-AA-000 FD432S-LA-000 CD432S-AA-000	
		SMH110D-0105-20ABK-4LKC	2500P/R HFO18+HFO21 connector with brake	MOT-008-LL-KC2-B			
	1.26kW 2000rpm/6Nm	SMH110D-0126-20AAK-4LKC	2500P/R HFO18 series standard connector	MOT-008-LL-KC1			
SMH110D-0126-20ABK-4LKC		2500P/R HFO18+HFO21 connector with brake	MOT-008-LL-KC2-B				
1.25kW 3000rpm/4Nm	SMH110D-0125-30AAK-4LKC	2500P/R HFO18 series standard connector	MOT-008-LL-KC1				
	SMH110D-0125-30ABK-4LKC	2500P/R HFO18+HFO21 connector with brake	MOT-008-LL-KC2-B				
Medium Inertia 380V	1.26kW 3000rpm/4Nm	SMH110D-0126-30AAK-4HKC	2500P/R HFO18 series standard connector	MOT-008-LL-KC1			
		SMH110D-0126-30ABK-4HKC	2500P/R HFO18+HFO21 connector with brake	MOT-008-LL-KC2-B			
	1.57kW 3000rpm/5Nm	SMH110D-0157-30AAK-4HKC	2500P/R HFO18 series standard connector	MOT-008-LL-KC1			
		SMH110D-0157-30ABK-4HKC	2500P/R HFO18+HFO21 connector with brake	MOT-008-LL-KC2-B			
1.88kW 3000rpm/6Nm	SMH110D-0188-30AAK-4HKC	2500P/R HFO18 series standard connector	MOT-008-LL-KC1				
	SMH110D-0188-30ABK-4HKC	2500P/R HFO18+HFO21 connector with brake	MOT-008-LL-KC2-B				

Note: User select the compatible motors themselves.
 • It needs CD24V/2A delay when driver drive the brake device.

Servo Driver and Motor Selection Table

JD/FD2S/CD2S Servo Driver and Motor Selection Table (2)

Category	Rated Power/ Rated Speed/ Rated Torque	Servo Motor	Description	Power/ Brake Cable	Encoder Cable	Servo Driver
Medium Inertia 220V/380V	1.05kW 2000rpm/5Nm	SMH130D-0105-20AAK-4HKC	2500P/R YL series standard connector	MOT-008-LL-KC2	ENCCA-LL-KC1	JD430-AA-000 JD620-AA-000 FD432S-CA-000 FD432S-AA-000 FD622S-CA-000 FD622S-AA-000 FD432S-LA-000 FD622S-LA-000 CD432S-AA-000 CD622S-AA-000
		SMH130D-0105-20ABK-4HKC •	2500P/R YL series standard connector with brake	MOT-008-LL-KC2-B		
	1.57kW 2000rpm/7.5Nm	SMH130D-0157-20AAK-4HKC	2500P/R YL series standard connector	MOT-008-LL-KC2		
		SMH130D-0157-20ABK-4HKC •	2500P/R YL series standard connector with brake	MOT-008-LL-KC2-B		
Medium Inertia 380V	2.1kW 2000rpm/10Nm	SMH130D-0210-20AAK-4HKC	2500P/R YL series standard connector	MOT-008-LL-KC2		
		SMH130D-0210-20ABK-4HKC •	2500P/R YL series standard connector with brake	MOT-008-LL-KC2-B		
	2.3kW 2000rpm/11.1Nm	SMH150D-0230-20AAK-4HKC	2500P/R YL series standard connector	MOT-008-LL-KC2		
		SMH150D-0230-20ABK-4HKC •	2500P/R YL series standard connector with brake	MOT-008-LL-KC2-B		
	3kW 2000rpm/14.3Nm	SMH130D-0300-20AAK-4HKC	2500P/R YL series standard connector	MOT-008-LL-KC2		
		SMH130D-0300-20ABK-4HKC •	2500P/R YL series standard connector with brake	MOT-008-LL-KC2-B		
	3kW 2000rpm/14.3Nm	SMH150D-0300-20AAK-4HKC	2500P/R YL series standard connector	MOT-008-LL-KC2		
		SMH150D-0300-20ABK-4HKC •	2500P/R YL series standard connector with brake	MOT-008-LL-KC2-B		
	3.8kW 2000rpm/18Nm	SMH150D-0380-20AAK-4HKC	2500P/R YL series standard connector	MOT-015-LL-KC2		
		SMH150D-0380-20ABK-4HKC •	2500P/R YL series standard connector with brake	MOT-015-LL-KC2-B		
	3.5kW 1500rpm/22Nm	SMH180D-0350-15AAK-4HKC	2500P/R YL series standard connector	MOT-015-LL-KC2		
		SMH180D-0350-15ABK-4HKC •	2500P/R YL series standard connector with brake	MOT-015-LL-KC2-B		
	4.4kW 1500rpm/28Nm	SMH180D-0440-15AAK-4HKC	2500P/R YL series standard connector	MOT-015-LL-KC2		
		SMH180D-0440-15ABK-4HKC •	2500P/R YL series standard connector with brake	MOT-015-LL-KC2-B		
5.5kW 1500rpm/35Nm	SMH180D-0550-15RAK-4HKC	SMT37 Resolver YL series standard connector	MOT-015-LL-KC2			
	SMH180D-0550-15RBK-4HKC •	SMT37 Resolver YL series standard connector with brake	MOT-015-LL-KC2-B			
7.5kW 1500rpm/48Nm	SMH180D-0750-15RAK-4HKC	SMT37 Resolver YL series standard connector	MOT-030-LL-KC3	ENCCR-LL-FC1	JD640-AR-000 JD650-AR-000	
Small Inertia DC60V	50W 3000rpm/0.16Nm	SMH40S-0005-30AAK-4DKH	2500P/R Cable connector	MOT-005-LL-KL-D	ENCCA-LL-KH	FD122-CA-000 FD122-AA-000 FD122-LA-000
		SMH40S-0005-30ABK-4DKH	2500P/R Cable connector with brake	MOT-005-LL-KL-D BRA-LL-KL		
	100W 3000rpm/0.32Nm	SMH40S-0010-30AAK-4DKH	2500P/R Cable connector	MOT-005-LL-KL-D		
		SMH40S-0010-30ABK-4DKH	2500P/R Cable connector with brake	MOT-005-LL-KL-D BRA-LL-KL		
	1Nm	57S-0010-10AAK-FDFH	2500P/R Multi-pole servo motor	MOT-005-LL-KL-D	ENCCF-LL-FH	
		57S-0015-08AAK-FDFH				
	2.4Nm	85S-0020-05AAK-FLFN-02	2500P/R Multi-pole servo motor	MOTE-005-LL-KC0	ENCCF-LL-FC0	
		85S-0050-10AAK-FLFN-03				
	200W 3000rpm/0.64Nm	SME60S-0020-30AAK-3DKH	2500P/R Wire saving encoder Cable connector	MOT-005-LL-KL-D	ENCCF-LL-FH	
		SME60S-0020-30ABK-3DKH	2500P/R Wire saving encoder Cable connector with brake	MOT-005-LL-KL-D/ BRA-LL-KL		
	400W 3000rpm/1.27Nm	SME60S-0040-30AAK-3DKH	2500P/R Wire saving encoder Cable connector	MOT-008-LL-KL-D		
		SME60S-0040-30ABK-3DKH	2500P/R Wire saving encoder Cable connector with brake	MOT-008-LL-KL-D/ BRA-LL-KL		
400W 3000rpm/1.27Nm	SME80S-0040-30AAK-3DKH	2500P/R Wire saving encoder Cable connector	MOT-008-LL-KL-D			
	SME80S-0040-30ABK-3DKH	2500P/R Wire saving encoder Cable connector with brake	MOT-008-LL-KL-D/ BRA-LL-KL			

Note: User select the compatible motors themselves.
• It needs CD24V/2A delay when driver drive the brake device.

Servo Driver and Motor Selection Table

FD2S/CD2S Servo Driver and Motor Selection Table

Category	Rated Power/ Rated Speed/ Rated Torque	Servo Motor	Description	Power/ Brake Cable	Encoder Cable	Servo Driver
SMC Series	200W 3000rpm/0.64Nm	SMC60S-0020-30EAK-3LKH	2500P/R Wire saving encoder Cable connector	MOT-005-LL-KL	ENCCF-LL-FH	FD422S-CA-000 FD422S-AA-000 FD422S-LA-000 CD422S-AA-000
		SMC60S-0020-30EBK-3LKH	2500P/R Wire saving encoder Cable connector with brake	MOT-005-LL-KL/BRA-LL-KL		
	400W 3000rpm/1.27Nm	SMC60S-0040-30EAK-3LKH	2500P/R Wire saving encoder Cable connector	MOT-005-LL-KL		
		SMC60S-0040-30EBK-3LKH	2500P/R Wire saving encoder Cable connector with brake	MOT-005-LL-KL/BRA-LL-KL		
	750W 3000rpm/2.39Nm	SMC80S-0075-30EAK-3LKH	2500P/R Wire saving encoder Cable connector	MOT-005-LL-KL		
		SMC80S-0075-30EBK-3LKH	2500P/R Wire saving encoder Cable connector with brake	MOT-005-LL-KL/BRA-LL-KL		
	1kW 2000rpm/4.8Nm	SMC130D-0100-20EAK-4LKP	2500P/R Wire saving encoder, HFO18+HFO21 connector	MOT-005-LL-KC4		
		SMC130D-0100-20EBK-4LKP •	2500P/R Wire saving encoder, HFO18+HFO21 connector with brake	MOT-005-LL-KC4-B		
	1.5kW 2000rpm/7.2Nm	SMC130D-0150-20EAK-4LKP	2500P/R Wire saving encoder, HFO18+HFO21 connector	MOT-008-LL-KC4		
		SMC130D-0150-20EBK-4LKP •	2500P/R Wire saving encoder, HFO18+HFO21 connector with brake	MOT-008-LL-KC4-B		
	2kW 2000rpm/10Nm	SMC130D-0200-20EAK-4LKP	2500P/R Wire saving encoder, HFO18+HFO21 connector	MOT-008-LL-KC4		
		SMC130D-0200-20EBK-4LKP •	2500P/R Wire saving encoder, HFO18+HFO21 connector with brake	MOT-008-LL-KC4-B		
1.5kW 2000rpm/7.2Nm	SMC130D-0150-20EAK-4HKP	2500P/R Wire saving encoder, HFO18+HFO21 connector	MOT-005-LL-KC4			
	SMC130D-0150-20EBK-4HKP •	2500P/R Wire saving encoder, HFO18+HFO21 connector with brake	MOT-005-LL-KC4-B			
2kW 2000rpm/10Nm	SMC130D-0200-20EAK-4HKP	2500P/R Wire saving encoder, HFO18+HFO21 connector	MOT-008-LL-KC4			
	SMC130D-0200-20EBK-4HKP •	2500P/R Wire saving encoder, HFO18+HFO21 connector with brake	MOT-008-LL-KC4-B			
3kW 3000rpm/10Nm	SMC130D-0300-30EAK-4HKP	2500P/R Wire saving encoder, HFO18+HFO21 connector	MOT-008-LL-KC4			
	SMC130D-0300-30EBK-4HKP •	2500P/R Wire saving encoder, HFO18+HFO21 connector with brake	MOT-008-LL-KC4-B			
3kW 2000rpm/14.3Nm	SMC130D-0300-20EAK-4HKP	2500P/R Wire saving encoder, HFO18+HFO21 connector	MOT-008-LL-KC4			
	SMC130D-0300-20EBK-4HKP •	2500P/R Wire saving encoder, HFO18+HFO21 connector with brake	MOT-008-LL-KC4-B			
SMH Series	50W 3000rpm/0.16Nm	SMH40S-0005-30JAK-4LKH	20 bit single-turn encoder	MOT-005-LL-KL	ENCCG-LL-GU	FD412S-CA-000 FD412S-AA-000 FD412S-LA-000 CD412S-AA-000
		SMH40S-0005-30KAK-4LKH	16 bit multi-turn absolute encoder	MOT-005-LL-KL	ENCCG-LL-GU ENCCG-(4)-GU-BT	
	100W 3000rpm/0.32Nm	SMH40S-0010-30JAK-4LKH	20 bit single-turn encoder	MOT-005-LL-KL	ENCCG-LL-GU	
		SMH40S-0010-30KAK-4LKH	16 bit multi-turn absolute encoder	MOT-005-LL-KL	ENCCG-LL-GU ENCCG-(4)-GU-BT	
SMS Series	200W 3000rpm/0.64Nm	SMS60S-0020-30JAK-3LKH	20 bit single-turn encoder	MOT-005-LL-KL	ENCCG-LL-GU	
		SMS60S-0020-30JBK-3LKH	20 bit single-turn encoder, with brake	MOT-005-LL-KL/BRA-LL-KL		
		SMS60S-0020-30KAK-3LKH	16 bit multi-turn absolute encoder	MOT-005-LL-KL		
		SMS60S-0020-30KBK-3LKH	16 bit multi-turn absolute encoder, with brake	MOT-005-LL-KL/BRA-LL-KL		
	400W 3000rpm/1.27Nm	SMS60S-0040-30JAK-3LKH	20 bit single-turn encoder	MOT-005-LL-KL		
		SMS60S-0040-30JBK-3LKH	20 bit single-turn encoder, with brake	MOT-005-LL-KL/BRA-LL-KL		
		SMS60S-0040-30KAK-3LKH	16 bit multi-turn absolute encoder	MOT-005-LL-KL		
		SMS60S-0040-30KBK-3LKH	16 bit multi-turn absolute encoder, with brake	MOT-005-LL-KL/BRA-LL-KL		
750W 3000rpm/2.39Nm	SMS80S-0075-30JAK-3LKH	20 bit single-turn encoder	MOT-005-LL-KL			
	SMS80S-0075-30JBK-3LKH	20 bit single-turn encoder, with brake	MOT-005-LL-KL/BRA-LL-KL			
	SMS80S-0075-30KAK-3LKH	16 bit multi-turn absolute encoder	MOT-005-LL-KL			
	SMS80S-0075-30KBK-3LKH	16 bit multi-turn absolute encoder, with brake	MOT-005-LL-KL/BRA-LL-KL			

Note: User select the compatible motors themselves.
• It needs CD24V/2A delay when driver drive the brake device.

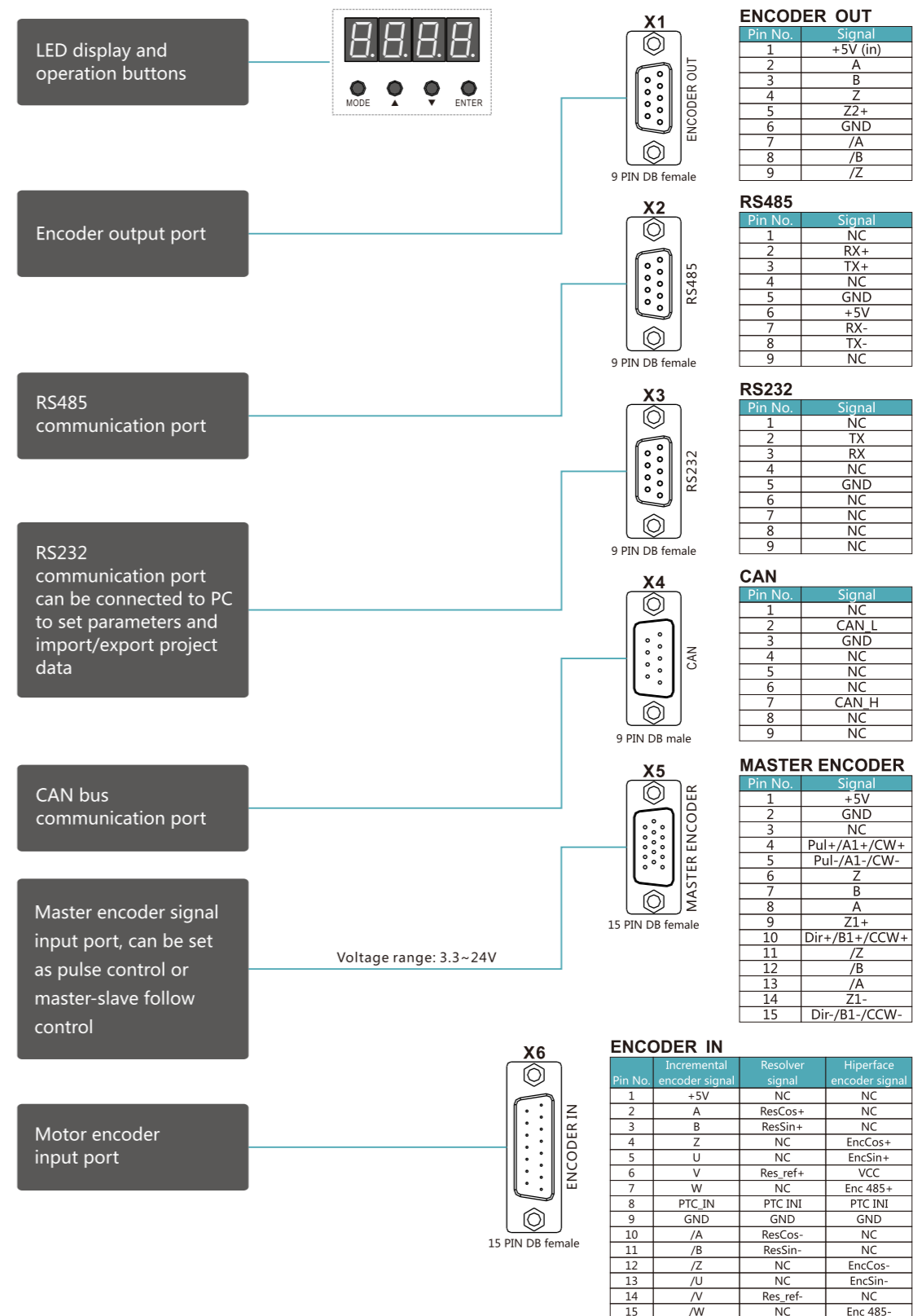
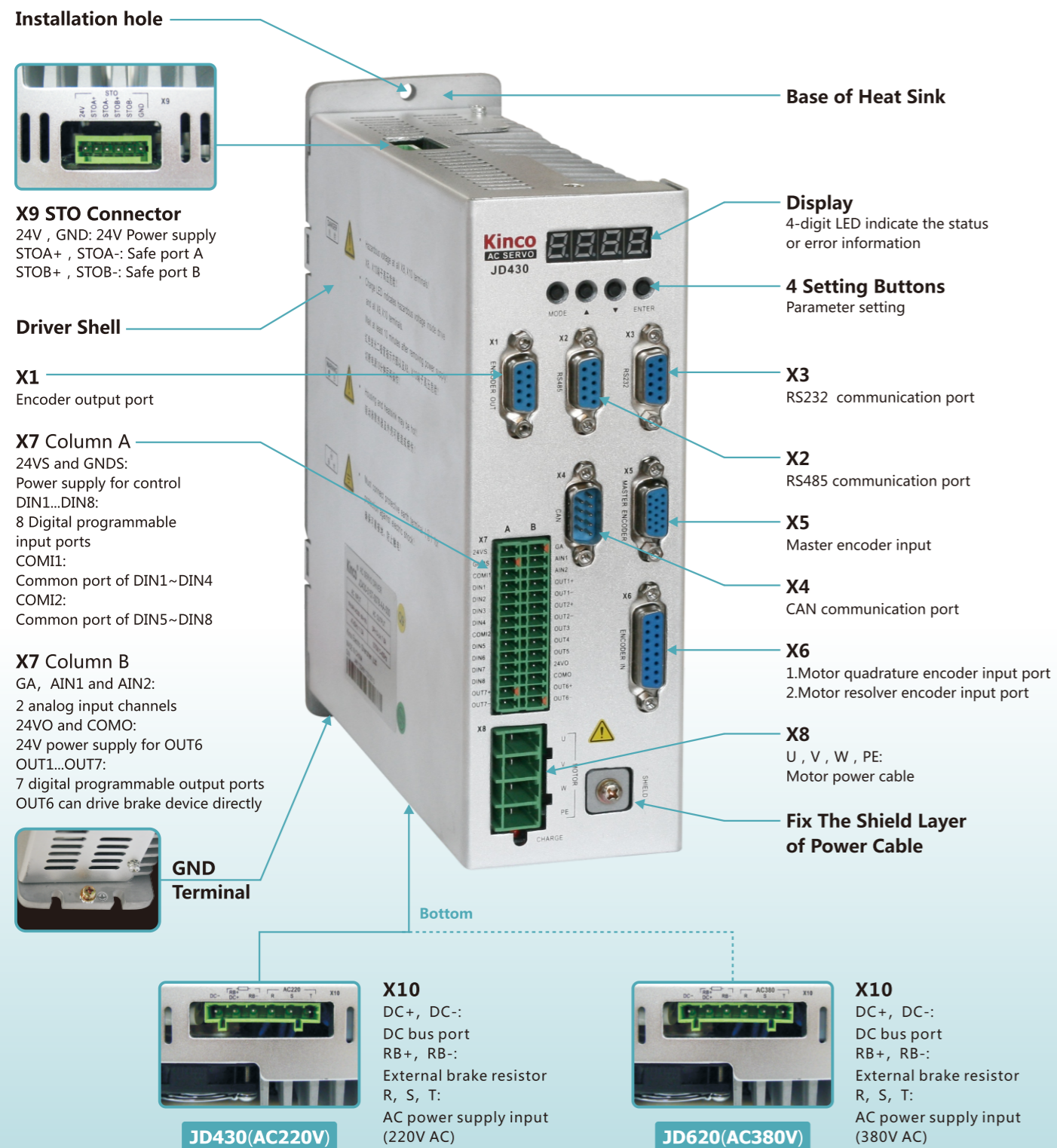

Note: 1. JD430/JD620 drivers share the same interface definition, except for X10 power interfaces.
2. Suggested brake resistor: JD430 39ohms/200W or 75ohms/100W, JD620 75ohms/200W, JD630 & JD640 47ohms/500W.
The customer should chose the power of brake resistor according to the actual application.

Technical Specifications of JD Servo Driver

Model Parameter	JD430-AA-000	JD620-AA-000	JD630-□A-000	JD640-□R-000	JD650-AR-000	
Power	Main supply voltage	Single-phase or 3-phase AC220V -20/+15% 47~63Hz	3-phase AC380V -20/+15% 47~63Hz	3-phase AC380V -20/+15% 47~63Hz	3-phase AC380V -20/+15% 47~63Hz	3-phase AC380V -20/+15% 47~63Hz
	Control circuit voltage	18VDC~30VDC 1A	18VDC~30VDC 1A	18VDC~30VDC 1A	18VDC~30VDC 1A	18VDC~30VDC 1A
Current	Rated current (RMS)	10A	7A	10A	13A	18A
	Peak current (PEAK)	27.5A	25A	35A	45A	65A
Brake chopper threshold	DC380V±5V	DC680V±5V	DC680V±5V	DC680V±5V	DC680V±5V	DC680V±5V
Over-voltage alarming threshold	DC400V±5V	DC700V±5V	DC700V±5V	DC700V±5V	DC700V±5V	DC700V±5V
Under-voltage alarming threshold	DC200V±5V	DC400V±5V	DC400V±5V	DC400V±5V	DC400V±5V	DC400V±5V
Cooling method	Forced air cooling		Forced air cooling		Forced air cooling	
Weight (Kg)	2.51		3.62		6.7	
Size(W*H*D, mm)	220×195×66		255×230×77		320×280.5×95	
General Functions	Digital operation panel	4 buttons and 4 LED display				
	External I/O	7 digital outputs(OUT1, OUT2, OUT7 are 0.1A and OUT3~OUT6 are 0.5A, can define driver ready and other functions freely;				
		8 digital inputs(12.5~30V), can define driver enables and other functions freely.				
	Analog input	2 analog inputs, can be used to control speed and torque, the input range is -10V~10V				
	Encoder signal output function	Output encoder signal and master encoder signal are optional, can be used in the multiple axes synchronization, the max. output frequency is 2MHz. Do not support this function if driver is matched with resolver motor.				
	Master encoder input function	Can receive 3.3V~24V pulse/direction signal, CW/CCW signal, and the RS422 difference signal, the max. input frequency is 4MHz.				
	Feedback signal	Incremental encoder 2500P/R				
		Resolver, Hiperface/sincos® Encoder 16 bit multi-turn absolute encoder, 20 bit single-turn absolute encoder				
	RS232	The max. baudrate is 115.2KHz, use JD-PC software to communicate with PC, or via free protocol to communicate with controller				
	RS485	The max. baudrate is 115.2KHz, use Modbus RTU protocol to communicate with controller				
CAN BUS	The max. baudrate is 1MHz, use CANopen protocol to communicate with controller					
STO function	STO port can be connected to safe controller, switch, and sensor to protect the system					
Operation Environment	Operating temperature	0~40°C				
	Storage temperature	-10~70°C				
	Humidity (non-condensing)	Below 90% RH				
	Protection class	IP20				
	Installation environment	Installed in a dust-free, dry and lockable environment (such as in a electrical cabinet)				
	Installation mode	Vertical installation				
Height	No power limitation below 1000m					
Atmospheric pressure	86~106kpa					

Note① : □=LA : Communication port RS232, RS485

□=AA: Communication port RS232, RS485, CANopen

□=AR : Communication port RS232, RS485, CANopen , support motor with Resolver

Note② : AA is a direct driving servo system

Mechanical Dimension Diagram of JD430/JD620

(Unit: mm)

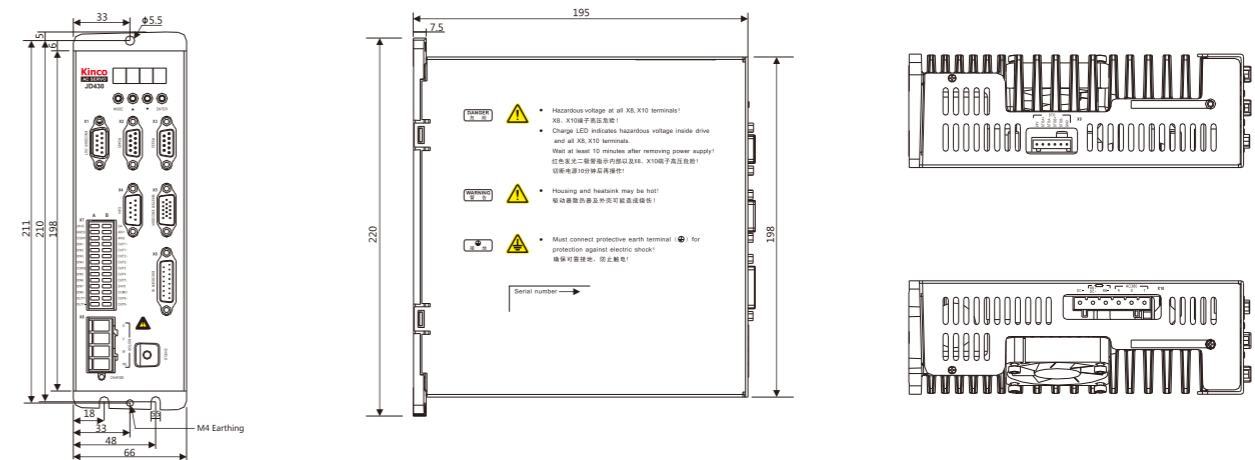

Mechanical Dimension Diagram of JD630/JD640

(Unit: mm)

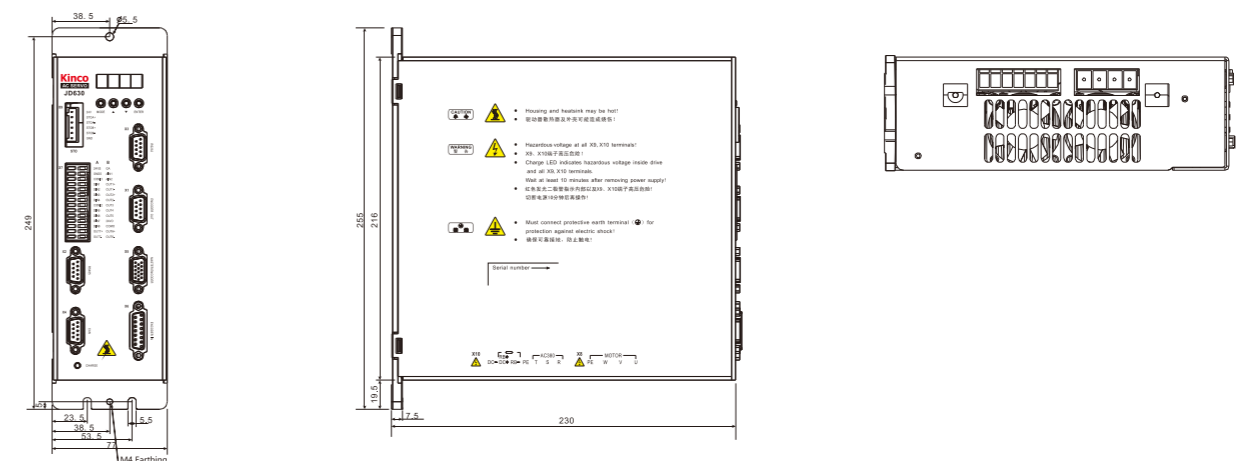

Mechanical Dimension Diagram of JD650

(Unit: mm)

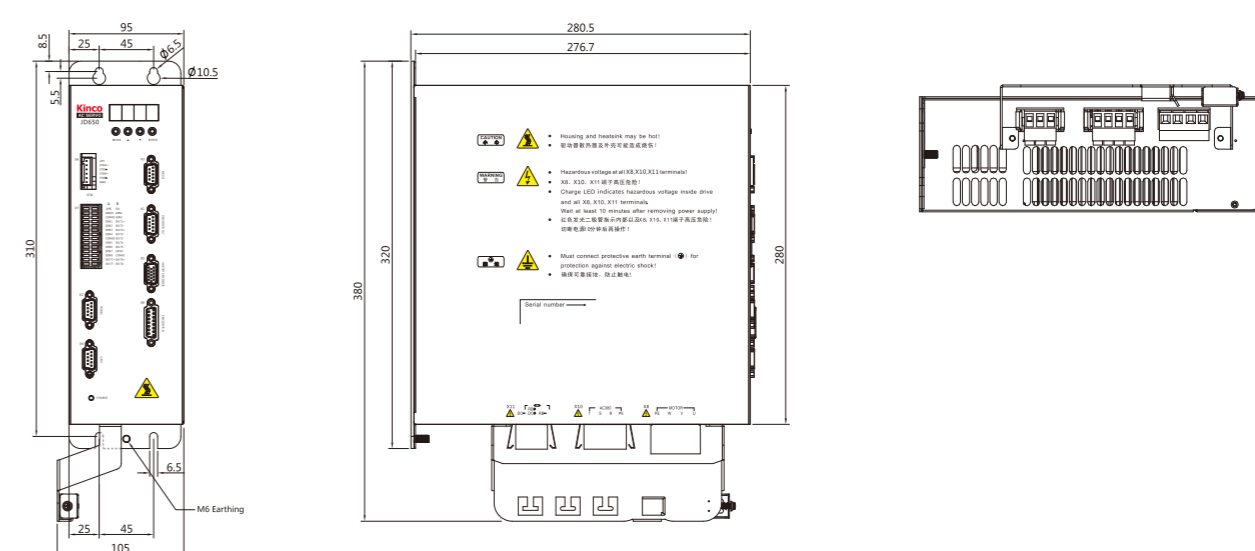

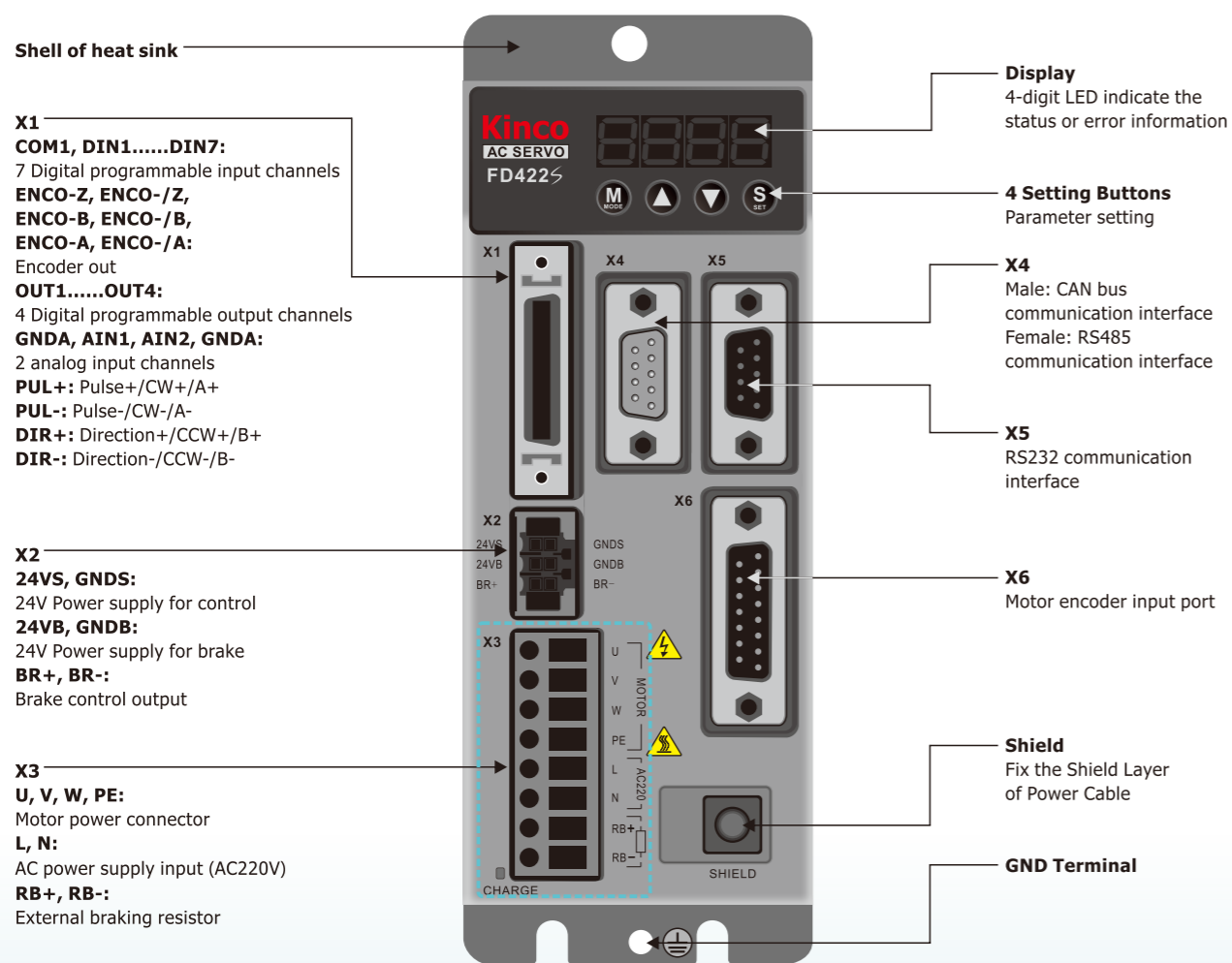

FD412S/FD422S (AC220V)

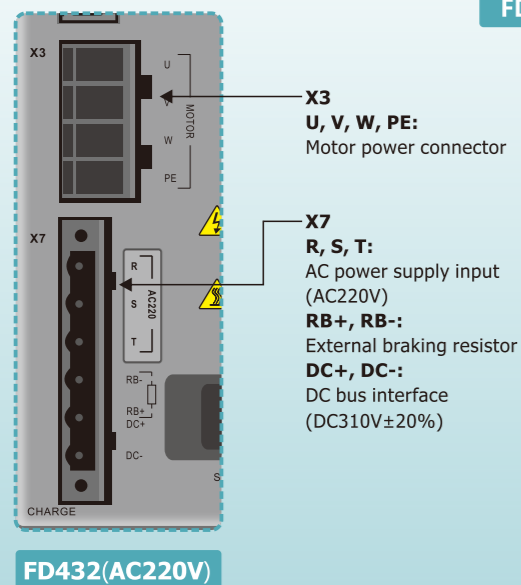

FD432(AC220V)

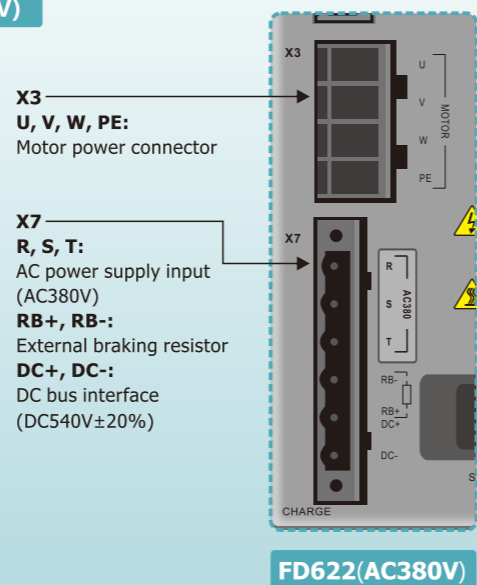

FD622(AC380V)

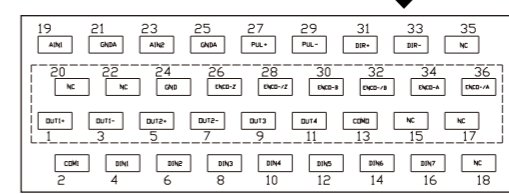

X1

Pin No.	Signal	Pin No.	Signal	Pin No.	Signal	Pin No.	Signal
2	COM1	1	OUT1+	20	NC	19	AIN1
4	DIN1	3	OUT1-	22	NC	21	GNDA
6	DIN2	5	OUT2+	24	GND	23	AIN2
8	DIN3	7	OUT2-	26	ENCO-Z	25	GNDA
10	DIN4	9	OUT3	28	ENCO-/Z	27	PUL+
12	DIN5	11	OUT4	30	ENCO-B	29	PUL-
14	DIN6	13	COM0	32	ENCO-/B	31	DIR+
16	DIN7	15	NC	34	ENCO-A	33	DIR-
18	NC	17	NC	36	ENCO-/A	35	NC



CAN

Pin No.	Signal
1	NC
2	CAN_L
3	GND
4	NC
5	NC
6	NC
7	CAN_H
8	NC
9	NC

RS485

Pin No.	Signal
1	NC
2	RX+
3	TX+
4	NC
5	GND
6	+5V
7	RX-
8	TX-
9	NC



RS232

Pin No.	Signal
1	NC
2	TX
3	RX
4	NC
5	GND
6	NC
7	NC
8	NC
9	NC

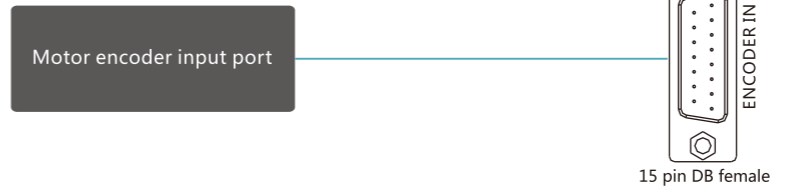

ENCODER IN

Pin No.	Incremental encoder signal	Communication encoder signal
1	+5V	+5V
2	A	NC
3	B	NC
4	Z	NC
5	U	NC
6	V	NC
7	W	SD
8	PTC_IN	NC
9	GND	GND
10	/A	NC
11	/B	NC
12	/Z	NC
13	/U	NC
14	/V	NC
15	/W	/SD

Note: 1. FD412S/FD422S/FD432S/FD622S share the same interface definition except the X3 and X7 power interfaces;
 2. Suggested brake resistor: FD412S/FD422S 75ohms/100W, FD432S 39ohms/200W, FD622S 75ohms/200W. The customer should choose the power of brake resistor according to the actual application.

Technical Specifications of FD2S Servo Driver

Model Parameter	FD412S-□A-000	FD422S-□A-000	FD422S-□F-000	FD432S-□A-000	FD612S-□A-000	FD622S-□A-000	
Power	Main supply voltage			Single-phase or 3-phase AC220V -20/+15% 47~63Hz	3-phase AC380V -20/+15% 47~63Hz		
	Control circuit voltage						18VDC~30VDC 1A
Current	Rated current(RMS)			2A	4A	5A	
	Peak current(PEAK)			7A	15A	15A	
Feedback signal							2500PPR (incremental encoder with 5V supply), 16 bit multi-turn absolute encoder, 20 bit single-turn absolute encoder
Brake chopper							Use an external braking resistor according to application, mainly in occasion of quick stop.
Brake chopper threshold							DC380V±5V
Over-voltage alarming threshold							DC400V±5V
Under-voltage alarming threshold							DC200V±5V
Cooling method							Natural air cooling
Weight(Kg)							1.2
General Functions	Digital input specification						7 digital inputs, with COM1 terminal for PNP (high level valid 12.5-30V) or NPN (low level valid) connection.
	Digital input function						Define freely according to requirement, supporting following functions: Driver enable, driver fault reset, driver mode control, proportional control, positive limit, negative limit, homing signal, reverse command, internal speed section control, internal positive section control, quick stop, start homing, active command, switch electronic gear ratio, switch gain
	Digital output specification						5 digital outputs, OUT1 ~ OUT4 current is 100mA, BR+/BR- (Brake control output) current is 500mA, can drive brake device directly
	Digital output function						Define freely according to requirement, supporting following functions: Driver ready, driver fault, position reached, motor at zero speed, motor brake, motor speed reached, Z signal, maximum speed obtained in torque mode, motor brake, position limiting, reference found, multi-position reached.
	Analog input						2 analog input, can be used to control speed and torque, the input range is -10V~10V.
	Encoder signal output function						Output encoder signal is optional, can be used in the multiple axes synchronization, the max. output frequency is 2MHz. Motor A、B、Z signal, Plus signal (PLS+DIR、CW/CCW、A+B)
	RS232						The max. baudrate is 115.2KHz, use JD-PC software to communicate with PC, or via free protocol to communicate with controller.
	Protection functions						Over-voltage protection, under-voltage protection, motor over-heat protection(I ² T), short-circuit protection, drive over-heat protection, etc.
RS485							The max. baudrate is 115.2KHz, use Modbus RTU protocol to communicate with controller.
CAN BUS							The max. baudrate is 1MHz, use CANopen protocol to communicate with controller.
Operation Environment	Operating temperature						0~40°C
	Storage temperature						-10°C~70°C
	Humidity(non-condensing)						Below 90%RH
	Protection class						IP20
	Installation environment						Installed in a dust-free, dry and lockable environment (such as in a electrical cabinet)
	Installation mode						Vertical installation
Height						No power limitation below 1000m	
Atmospheric pressure						86kpa~106kpa	

Note①: □=L: Communication port RS232, RS485
□=A/C: Communication port RS232, CANopen

Note②: AA is a direct driving servo system

Mechanical Dimension Diagram of FD412S/FD422S

(Unit: mm)

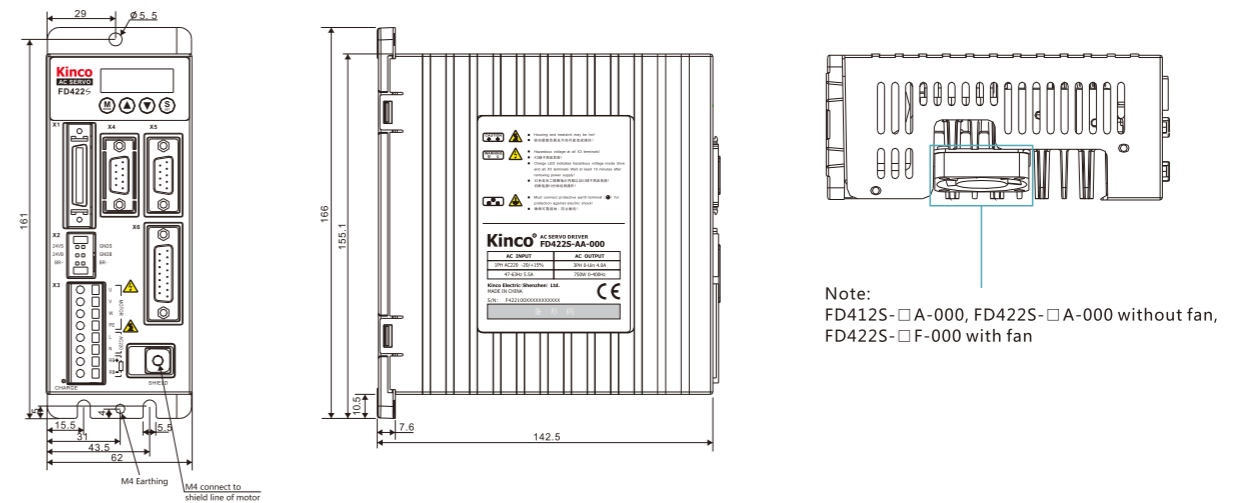

Mechanical Dimension Diagram of FD432S

(Unit: mm)

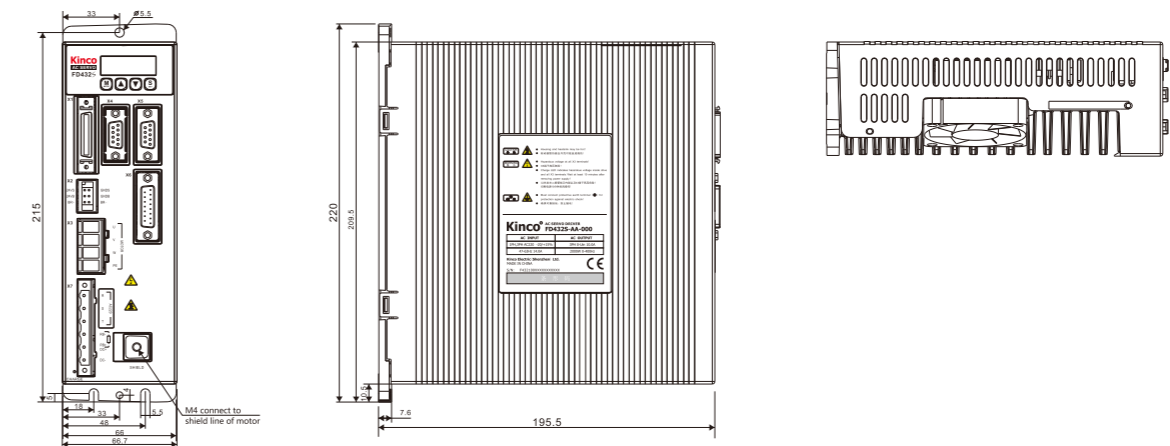

Mechanical Dimension Diagram of FD612S/FD622S

(Unit: mm)

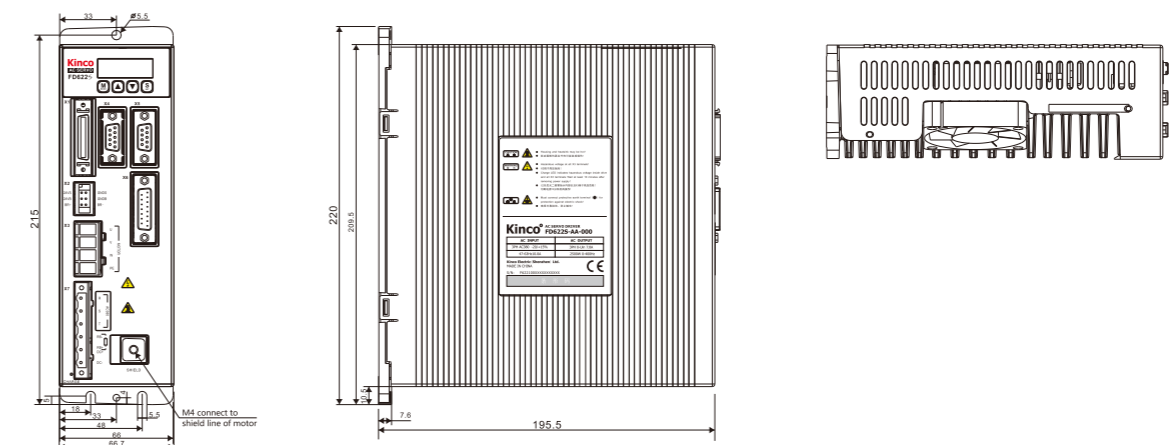

Panel and Interface Description of FD122 Servo Driver

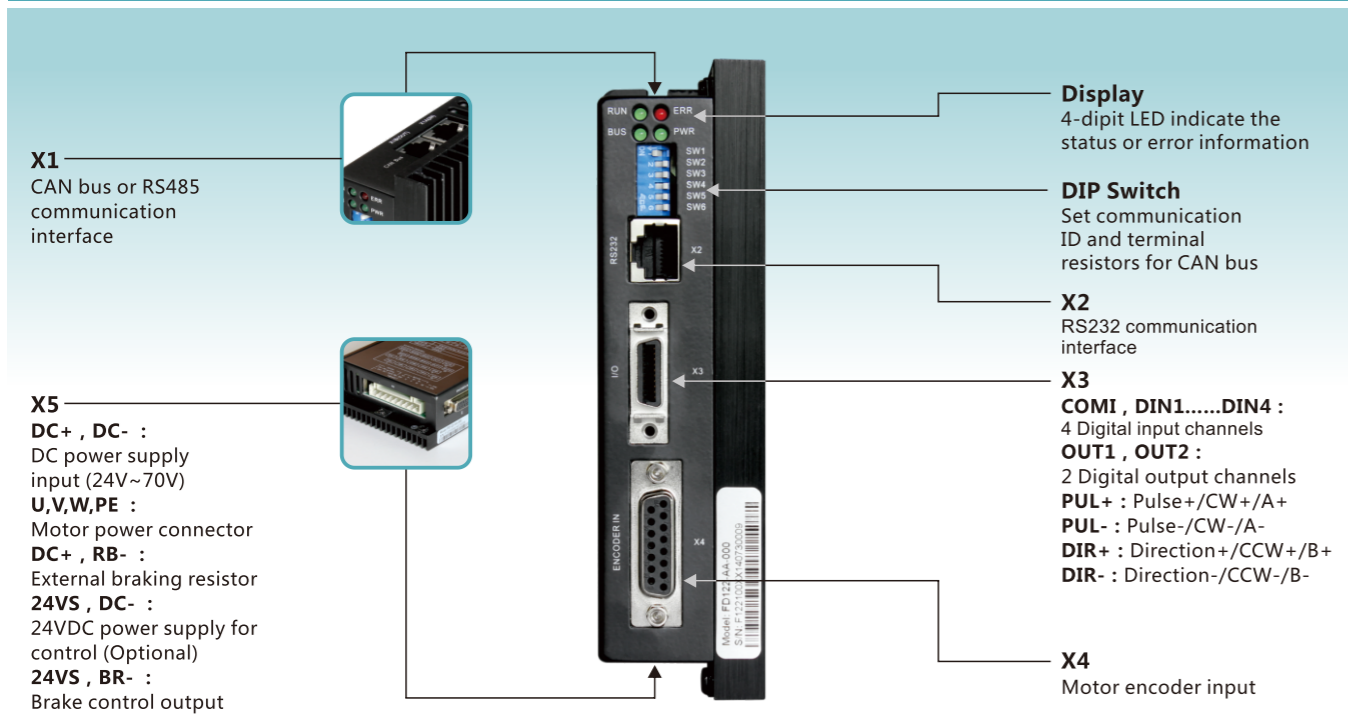

Port Description of FD122 Servo Driver

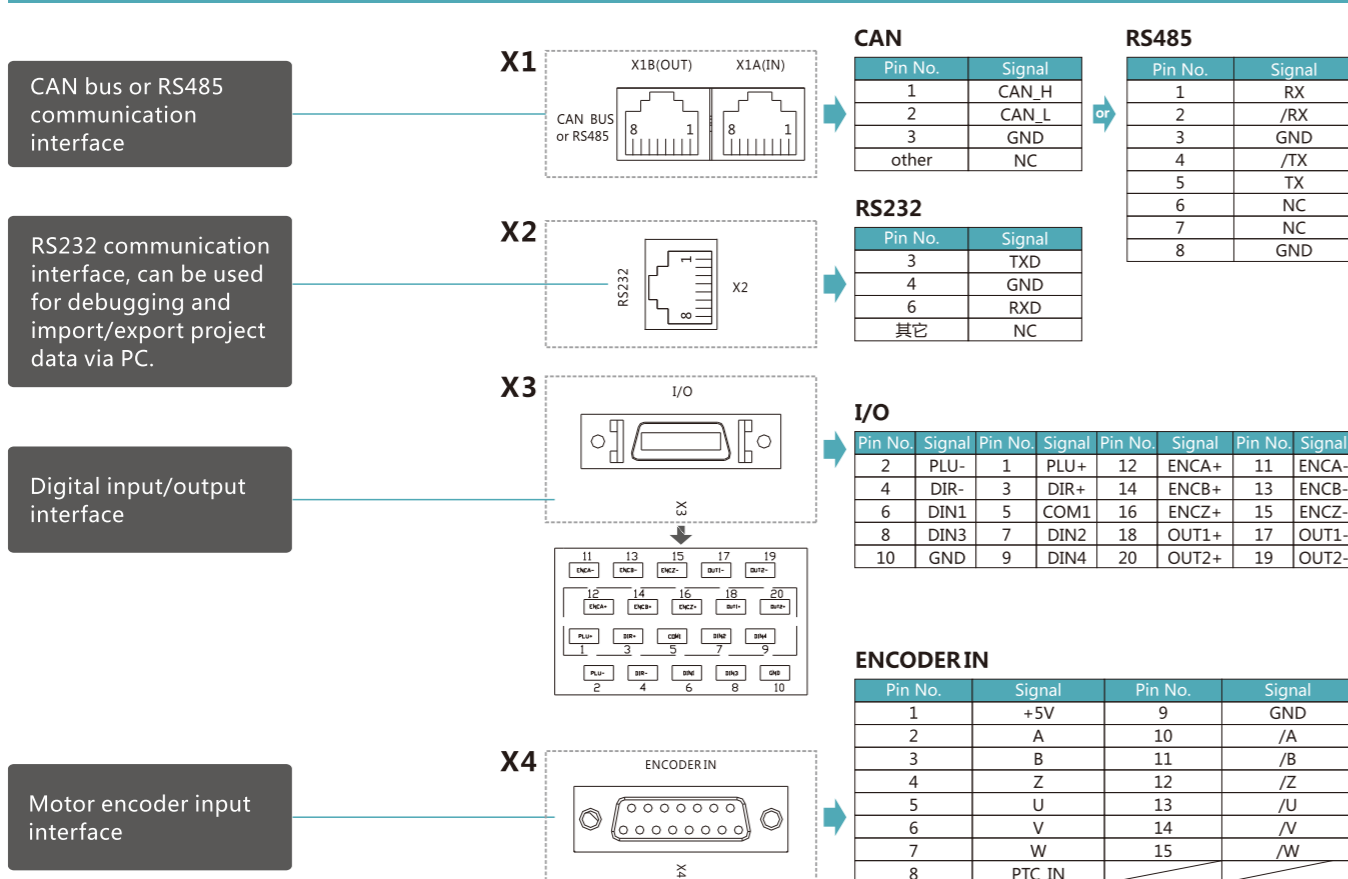

Technical Specifications Table of FD122 Servo Driver

Model parameter	FD122-LA-000	FD122-CA-000	FD122-AA-000
Power	Main supply voltage	24VDC ~ 70VDC	
	Control circuit voltage	DC24V 1A (Optional)	
Current	Rated current(RMS)	10A	
	Peak current(PEAK)	30A	
Feedback signal	2500PPR (incremental encoder with 5V supply)		
Brake chopper	Use an external braking resistor according to application, mainly in high speed start and stop application.		
Brake chopper threshold	DC79V ± 2V		
Over-voltage alarming threshold	DC86V ± 2V		
Under-voltage alarming threshold	18V ± 2V		
Cooling method	Natural air cooling		
Weight (Kg)	0.565		
General Functions	Input specification	4 digital inputs, with COMI terminal for PNP (high level valid 12.5-30V) or NPN (low level valid) connection.	
	Input function	Define freely according to requirement, supporting following functions: Driver enable, driver fault reset, driver mode control, proportional control, positive limit, negative limit, homing signal, reverse command, internal speed section control, internal positive section control, quick stop, start homing, active command, switch electronic gear ratio, switch gain	
	Output specification	3 digital outputs, OUT1-OUT2 current is 100mA, BR+/BR- (Brake control output) current is 500mA, can drive brake device directly	
	Output function	Define freely according to requirement, supporting following functions: Driver ready, driver fault, position reached, motor at zero speed, motor brake, motor speed reached, N signal, maximum speed obtained in torque mode, motor brake, position limiting, reference found, multi-position reached	
	Encoder Signal Output	Output the encoder signal of motor, Used in multiple axis synchronous control, supports 2MHz at most	
	RS232	The max. baud rate is 115.2KHz, use JD-PC software to communicate with PC, or via free protocol to communicate with controller.	
Protection Functions	Over-voltage protection, under-voltage protection, motor over-heat protection(I ² T), short-circuit protection, drive over-heat protection, etc		
CAN BUS	Supports 1M baud rate, communicates with controller via CANopen protocol		
Operation Environment	Operating temperature	0 ~ 40°C	
	Storage temperature	-10°C ~ 70°C	
	Humidity(non-condensing)	Below 90%RH	
	Protection class	IP20	
	Installation environment	Installed in a dust-free, dry and lockable environment(such as in a electrical cabinet)	
	Installation mode	Vertical installation	
Altitude	No power limitation below 1000m		
Atmospheric pressure	86kpa ~ 106kpa		

Note①: □=L: Communication port RS232, RS485
□=A/C: Communication port RS232, CANopen

Note②: AA is a direct driving servo system

Mechanical Dimension Diagram of FD122 (Unit: mm)

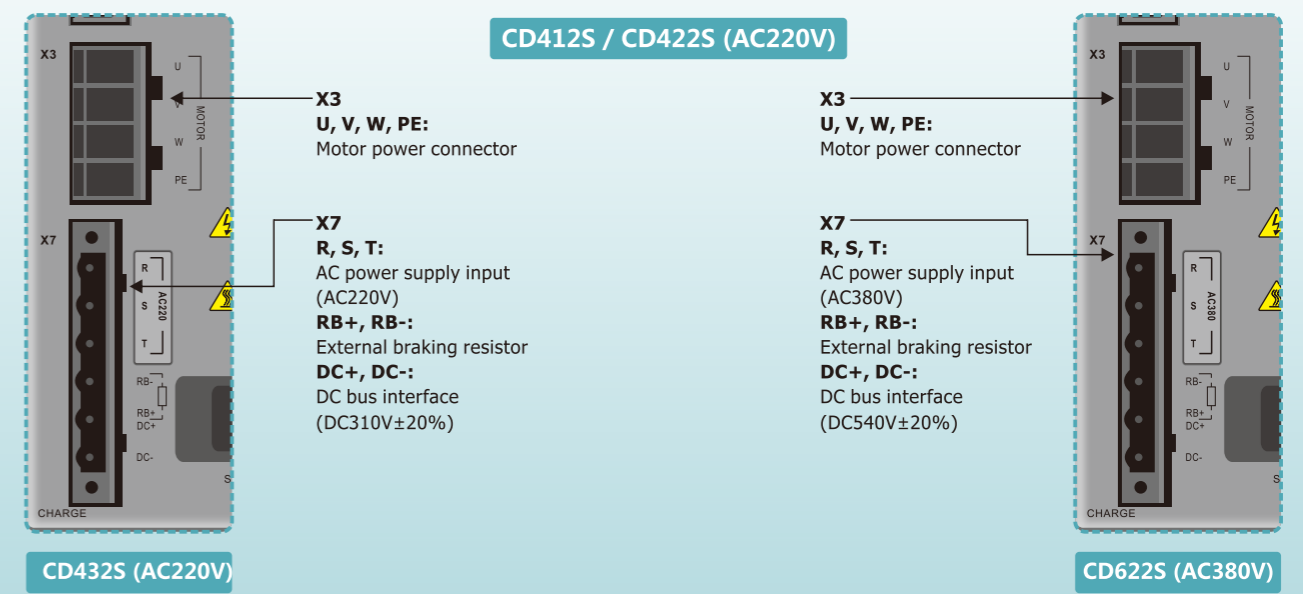
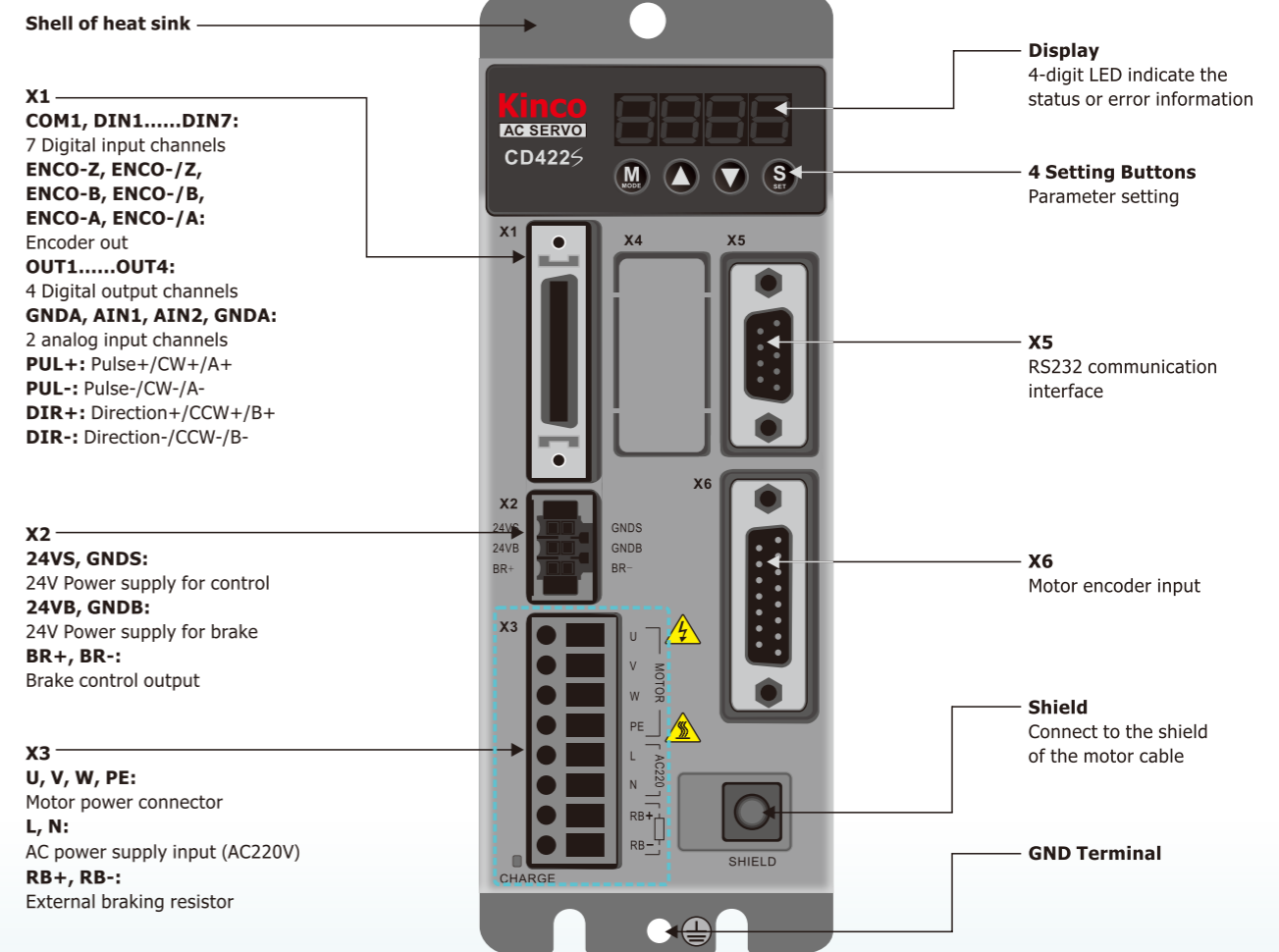
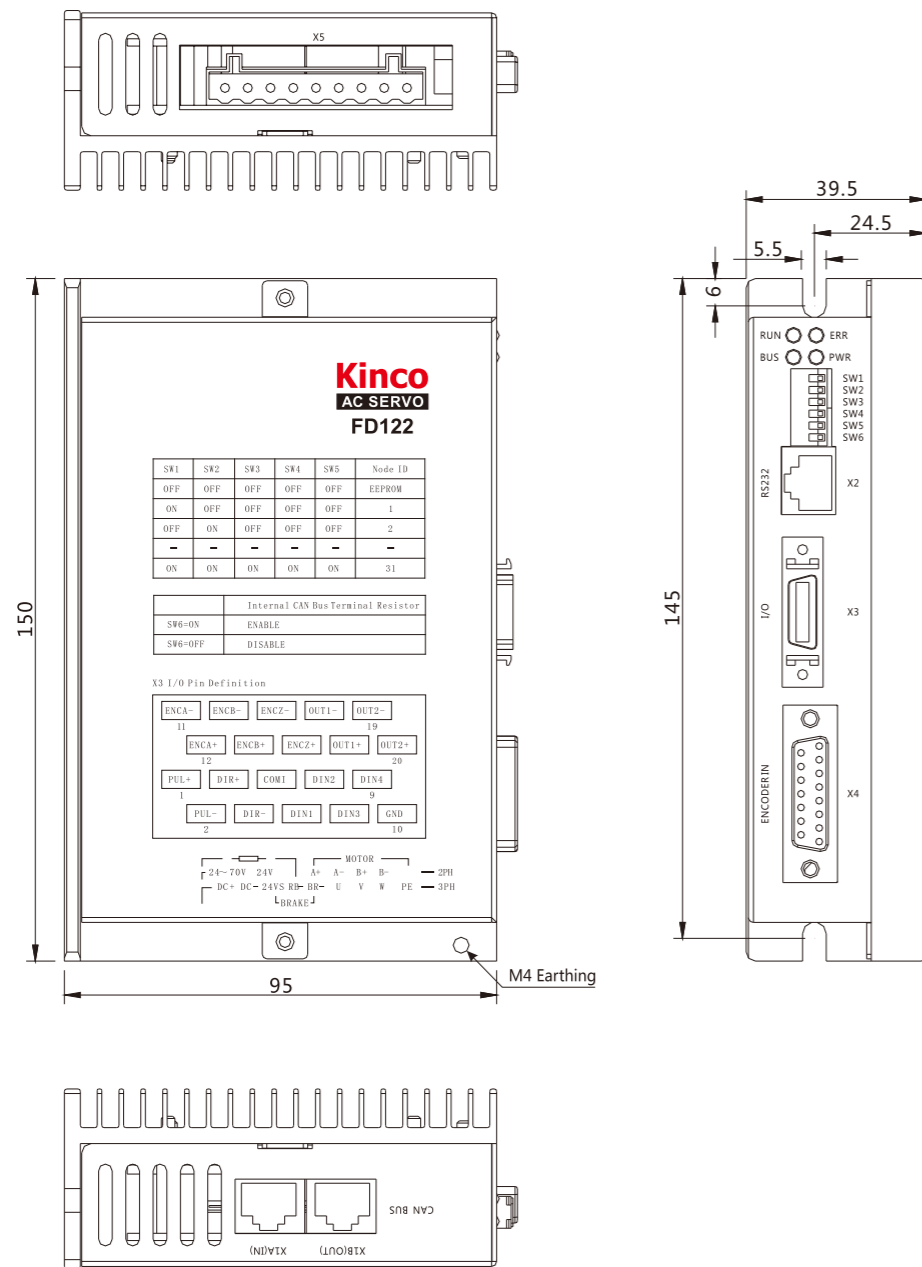

Note: 1. CD412S/CD422S/CD432S/CD622S drivers share the same interface definition, except for X3 and X7 power interfaces.
2. Suggested brake resistor: CD412S/CD422S 75ohms/100W, CD432S 39ohms/200W, CD622S 75Ω/200W, The customer should chose the power of brake resistor according to the actual application.

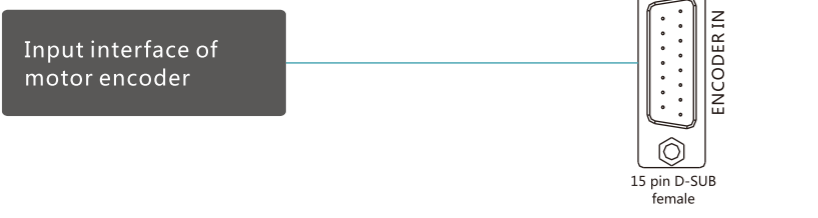
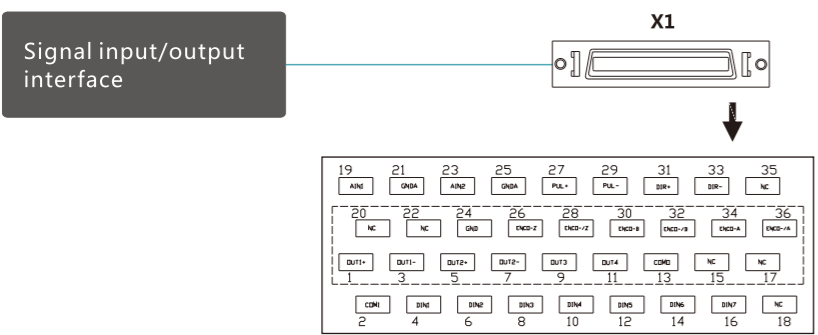

X1

Pin No.	Signal	Pin No.	Signal	Pin No.	Signal	Pin No.	Signal
2	COM1	1	OUT1+	20	NC	19	AIN1
4	DIN1	3	OUT1-	22	NC	21	GND A
6	DIN2	5	OUT2+	24	GND	23	AIN2
8	DIN3	7	OUT2-	26	ENCO-Z	25	GND A
10	DIN4	9	OUT3	28	ENCO-/Z	27	PUL+
12	DIN5	11	OUT4	30	ENCO-B	29	PUL-
14	DIN6	13	COM0	32	ENCO-/B	31	DIR+
16	DIN7	15	NC	34	ENCO-A	33	DIR-
18	NC	17	NC	36	ENCO-/A	35	NC

RS232

Pin No.	Signal
1	NC
2	TX
3	RX
4	NC
5	GND
6	NC
7	NC
8	NC
9	NC

ENCODER IN

Pin No.	Signal
1	+5V
2	A
3	B
4	Z
5	U
6	V
7	W
8	PTC_IN
9	GND
10	/A
11	/B
12	/Z
13	/U
14	/V
15	/W

Technical Specifications of CD2S Servo Driver

Model parameter	CD412S-AA-000	CD422S-AA-000	CD422S-AF-000	CD432S-AA-000	CD612S-AA-000	CD622S-AA-000
Power	Main supply voltage	Single-phase AC220V -20/+15% 47~63Hz			Single-phase or 3-phase AC220V -20/+15% 47~63Hz	3-phase AC380V -20/+15% 47~63Hz
	Control circuit voltage	18VDC~30VDC 1A				
Current	Max. continuous current	2A	4A	5A	11A	7A
	Peak current(PEAK)	7A	15A	15A	27.5A	25A
Feedback signal	2500PPR (incremental encoder with 5V supply) 16 bit multi-turn absolute encoder, 20 bit single-turn absolute encoder					
Brake chopper	Use an external braking resistor according to application, mainly in occasion of quick stop.					
Brake chopper threshold	DC380V±5V				DC680V±5V	
Over-voltage alarming threshold	DC400V±5V				DC700V±5V	
Under-voltage alarming threshold	DC200V±5V				DC400V±5V	
Cooling method	Natural air cooling		Fan	Fan		
Weight (Kg)	1.2		1.2	2.4		
Position Mode	Max. frequency of input pulse	Differential signal: 500KPPS, Open-collector signal: 200KPPS				
	Pulse command mode	Pulse+direction, CCW+CW, A+B phase(5V-24V)				
	Command smoothing	Low-pass filtering(Adjustable by internal parameter setting)				
	Feedforward gain	Adjustable by internal parameter setting				
	Electronic gear ratio	Setting range, Gear factor: -32768~32767, Gear divider: 1~32767, 1/50≤ Gear factor/Gear divider ≤50				
Position loop sampling frequency	1KHz					
Speed Mode	Analog input voltage range	-10V~+10V(Resolution 12bit)				
	Input impedance	200K				
	Analog input sampling frequency	4KHz				
	Command source	External analog command / internal command				
	Command smoothing	Low-pass filtering(Adjustable by internal parameter setting)				
	Input voltage dead-zone setting	Adjustable by internal parameter setting				
	Input voltage offset setting	Adjustable by internal parameter setting				
	Speed limit	Adjustable by internal parameter setting				
	Torque limit	Adjustable by internal parameter setting / External analog command control				
Speed loop sampling frequency	4KHz					
Torque Mode	Analog voltage input range	-10V~+10V(Resolution 12bit)				
	Input impedance	200K				
	Input sampling frequency	4KHz				
	Command source	External analog command / internal command				
	Command smoothing	Low-pass filtering(Adjustable by internal parameter setting)				
	Speed limit	Adjustable by internal parameter setting / External analog command control				
Digital Input	Input specification	7 digital inputs, with COM1 terminal for PNP (high level valid 12.5-30V) or NPN (low level valid) connection.				
	Input function	Define freely according to requirement, supporting following functions: Driver enable, driver fault reset, driver mode control, proportional control, positive limit, negative limit, homing signal, reverse command, internal speed section control, internal positive section control, quick stop, start homing, active command, switch electronic gear ratio, switch gain				
Digital Output	Output specification	5 digital outputs, OUT1~OUT4 current is 100mA, OUT5 current is 800mA, can drive brake device directly				
	Output function	Define freely according to requirement, supporting following functions: Driver ready, driver fault, position reached, motor at zero speed, motor brake, motor speed reached, Z signal, maximum speed obtained in torque mode, motor brake, position limiting, reference found, multi-position reached				
Protection functions	Over-voltage protection, under-voltage protection, motor over-heat protection(I ² T), short-circuit protection, drive over-heat protection, etc.					
Communication interface	RS232 (Connections with PC: 2-2, 3-3, 5-5)					
Operation Environment	Operating temperature	0~40°C				
	Storage temperature	-10°C~70°C				
	Humidity(non-condensing)	Below 90%RH				
	Protection class	IP20				
	Installation environment	Installed in a dust-free, dry and lockable environment(such as in a electrical cabinet)				
	Installation mode	Vertical installation				
	Altitude	No power limitation below 1000m				
Atmospheric pressure	86kpa~106kpa					

Wiring Diagram of CD2S Servo Driver

Mechanical Dimension Diagram of CD2S Servo Driver

Wiring Diagram for Position Control Mode

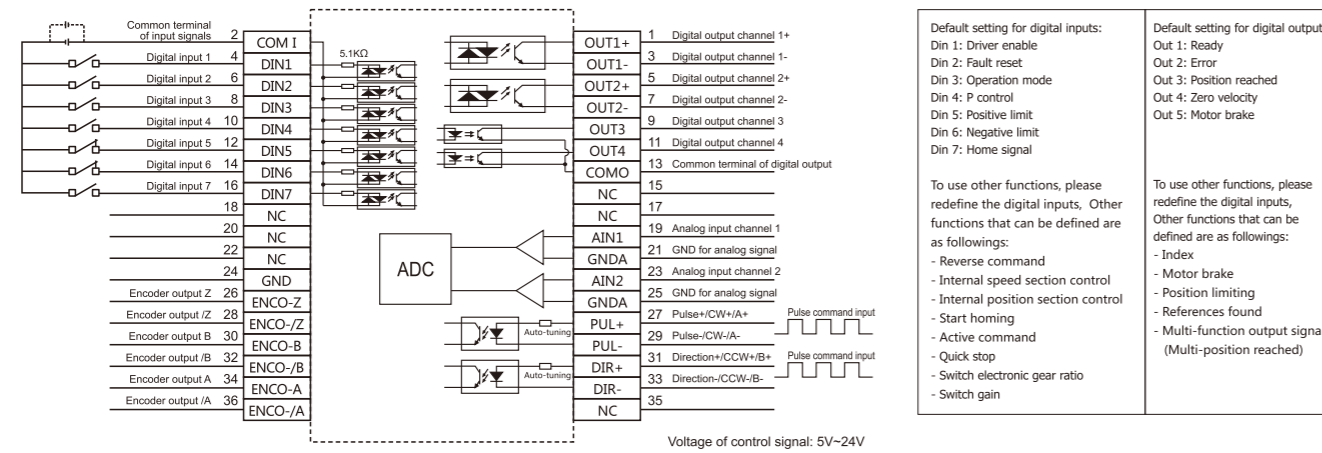

Mechanical Dimension Diagram of CD412S/CD422S

(Unit: mm)

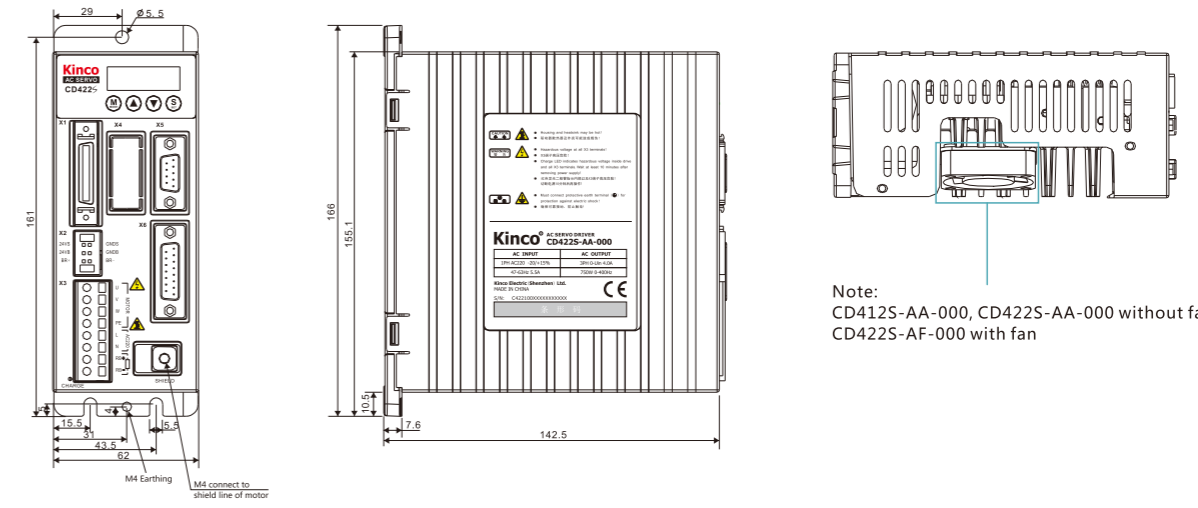

Wiring Diagram for Speed Control Mode

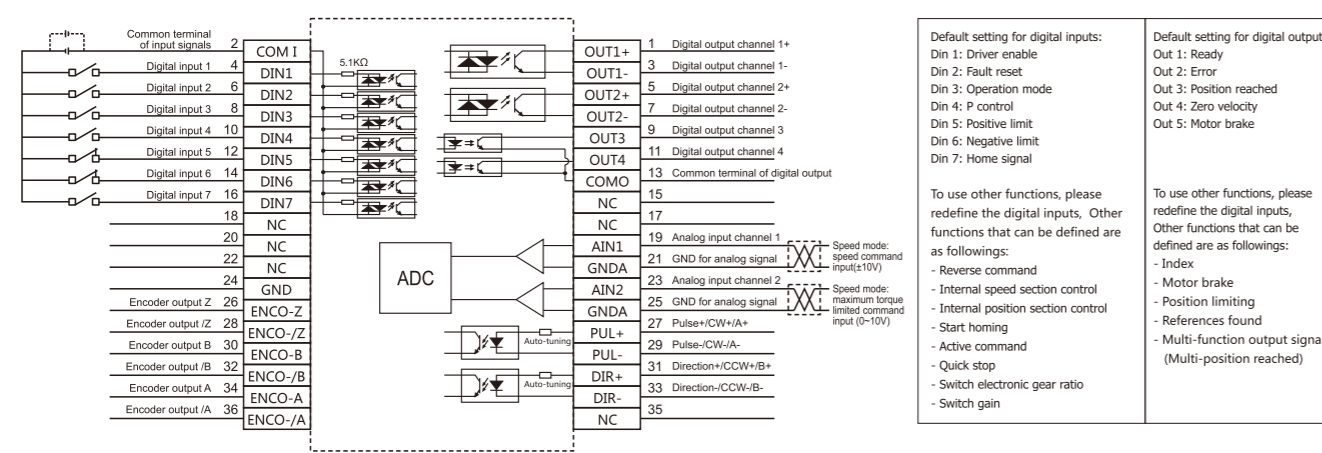

Mechanical Dimension Diagram of CD432S

(Unit: mm)

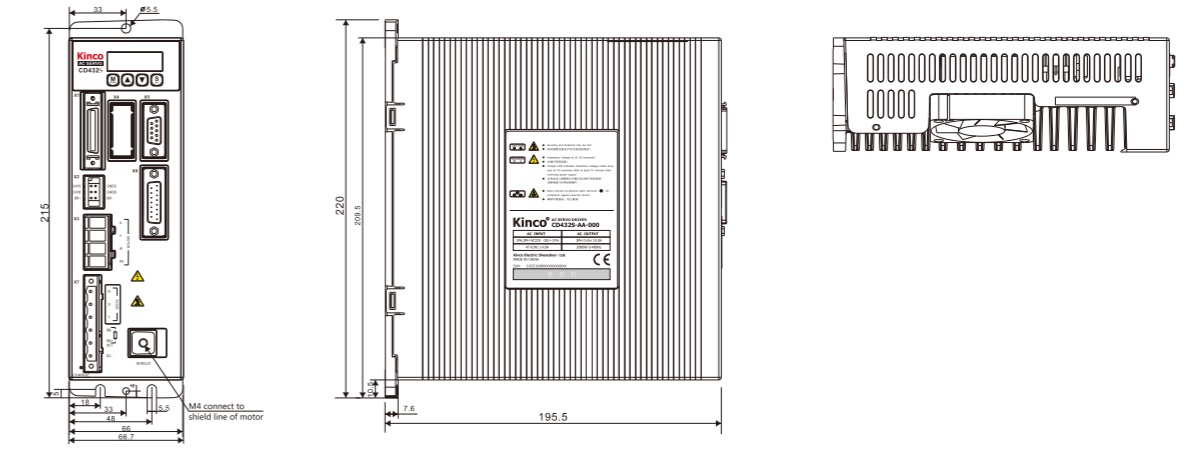

Wiring Diagram for Torque Control Mode

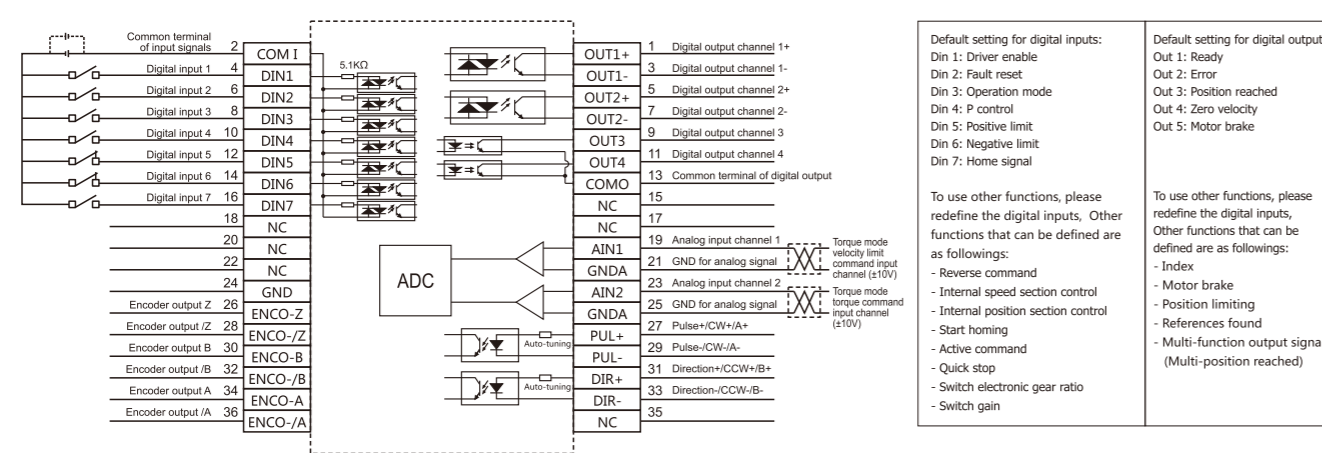

Mechanical Dimension Diagram of CD612S/CD622S

(Unit: mm)

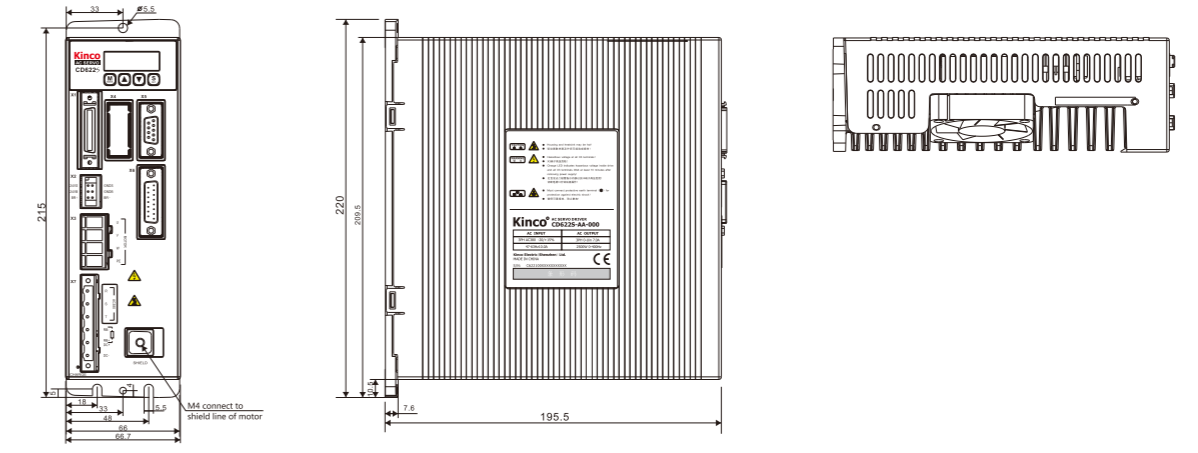

Technical Specifications of SMH Servo Motor

Technical Specifications of SMH Servo Motor

Technical Specifications of SMH Servo Motor (1)

Motor series	Small inertia flange size 40mm		Small inertia flange size 60mm		Small inertia flange size 80mm	
Model	SMH40S-0005-30A□K-4LKH	SMH40S-0010-30A□K-4LKH	SMH60S-0020-30A□K-3LK□	SMH60S-0040-30A□K-3LK□	SMH80S-0075-30A□K-3LK□	SMH80S-0100-30A□K-3LK□
Driver matching	FD412S-CA-000 FD412S-AA-000 FD412S-LA-000 CD412S-AA-000		JD430-AA-000 FD422S-CA-000 FD422S-AA-000 FD422S-LA-000 CD422S-AA-000		JD430-AA-000 FD432S-CA-000 FD432S-AA-000 FD432S-LA-000 CD432S-AA-000	
DC link voltage UDC	300	300	300	300	300	300
Continuous performance	Rated power P_n (W)	50	100	200	400	750
	Rated torque T_n (Nm)	0.16	0.32	0.64	1.27	2.39
	Rated speed n_n (rpm)	3000	3000	3000	3000	3000
	Rated current I_N (A)	0.7	1.4	1.6	3.1	3.9
Maximum torque T_m (Nm)	0.48	0.96	1.92	3.82	7.17	9.48
Maximum current I_m (A)	2.1	4.2	4.8	9.3	11.7	18.9
Standstill torque T_s (Nm)	0.176	0.352	0.7	1.39	2.63	3.3
Standstill current I_S (A)	0.77	1.54	1.79	3.38	4.4	6.93
Resistance line-line R_L (Ω)	16.6	5.53	8.02	3.52	1.4	0.86
Inductance line-line L_L (mH)	14	6	16.3	7.8	7.5	4.5
Electrical time constant τ_e (ms)	0.84	1.08	2.03	2.22	5.35	5.23
Mechanical time constant τ_m (ms)	1.28	0.86	2.26	1.35	0.75	0.89
Reverse voltage constant K_e (V/krpm)	16	14	29	29	40	34
Torque constant K_t (Nm/A)	0.265	0.265	0.48	0.48	0.662	0.562
Rotor moment of inertia J_m (Kg-cm ²)	0.031	0.059	0.375	0.51	1.36	1.9
	0.031 (with brake)	0.061 (with brake)	0.379 (with brake)	0.514 (with brake)	1.385 (with brake)	1.925 (with brake)
Pole pair number	4	4	3	3	3	3
Maximum voltage rising du/dt (KV/ μ s)	8	8	8	8	8	8
Insulation class	F	F	F	F	F	F
Maximum radial force F (N)	120	120	180	180	335	335
Maximum axial force F (N)	60	60	90	90	167.5	167.5
Weight G (Kg)	0.5	0.8	1.3	1.8	3.3	3.9
	0.8 (with brake)	1.0 (with brake)	1.8 (with brake)	2.3 (with brake)	4 (with brake)	4.6 (with brake)
Length of motor L (mm)	85.3±1	110.8±1	120	150	147	167
	119±1.5 (with brake)	145±1.5 (with brake)	159±1.5 (with brake)	189±1.5 (with brake)	197±1.5 (with brake)	217±1.5 (with brake)
Position feedback device	Incremental encoder 2500ppr					
Cooling method	Totally enclosed, non-ventilated					
Protection level	IP65 for body, shaft sealing IP54					
Environmental conditions for operation	Temperature	-20°C ~ 40°C (Non-freezing)				
	Humidity	Below 90% RH (Non-condensing)				
	Ambient environment	Away from active gas, combustible gas, oil drops and dust				
	Altitude	Maximum altitude 4000m, Rated power at 1000m or below, Above 1000m: Decreasing 1.5% per 100m rise				

Note : □=A —Without brake
 □=B —With brake
 □=H —Cable connector
 □=N —HFO18 series standard connector (Towards the shaft)
 □=O —HFO18 series standard connector (Opposite the shaft)
 □=P —HFO21+HFO18 (Power HFO21 connector, Encoder HFO18 connector)
 □=M —2xM17 series Intercontec connector

Technical Specifications of SMH Servo Motor (2)

Motor series	Medium inertia flange size 110mm					
Model	SMH110D-0125-30A□K-4LKC	SMH110D-0126-30A□K-4HKC	SMH110D-0105-20A□K-4LKC	SMH110D-0157-30A□K-4HKC	SMH110D-0126-20A□K-4LKC	SMH110D-0188-30A□K-4HKC
Driver matching	JD430-AA-000 FD432S-CA-000 FD432S-AA-000 FD432S-LA-000 CD432S-AA-000	JD620-AA-000 FD622S-CA-000 FD622S-AA-000 FD622S-LA-000 CD622S-AA-000	JD430-AA-000 FD432S-CA-000 FD432S-AA-000 FD432S-LA-000 CD432S-AA-000	JD620-AA-000 FD622S-CA-000 FD622S-AA-000 FD622S-LA-000 CD622S-AA-000	JD430-AA-000 FD432S-CA-000 FD432S-AA-000 FD432S-LA-000 CD432S-AA-000	JD620-AA-000 FD622S-CA-000 FD622S-AA-000 FD622S-LA-000 CD622S-AA-000
DC link voltage UDC	300	560	300	560	300	560
Continuous performance	Rated power P_n (W)	1250	1260	1050	1570	1260
	Rated torque T_n (Nm)	4.0	4.0	5.0	5.0	6.0
	Rated speed n_n (rpm)	3000	3000	2000	3000	2000
	Rated current I_N (A)	6.5	4.3	5.9	5.9	6.2
Maximum torque T_m (Nm)	12	12	15.0	15.0	18.0	
Maximum current I_m (A)	19.5	12.9	17.7	17.7	18.6	
Standstill torque T_s (Nm)	4.4	4.4	5.5	5.5	6.6	
Standstill current I_S (A)	6.82	4.73	6.49	6.49	6.765	
Resistance line-line R_L (Ω)	0.8	1.83	1.03	1.03	1.258	
Inductance line-line L_L (mH)	6.4	13.5	7.8	7.8	9.62	
Electrical time constant τ_e (ms)	7.9	7.37	7.57	7.57	7.64	
Mechanical time constant τ_m (ms)	1.4	1.63	1.55	1.55	1.65	
Reverse voltage constant K_e (V/krpm)	45	64	55	55	64	
Torque constant K_t (Nm/A)	0.744	1.058	0.910	0.910	1.058	
Rotor moment of inertia J_m (Kg-cm ²)	5.8	5.8	7.2	7.2	8.5	
	5.85 (with brake)	5.85 (with brake)	7.25 (with brake)	7.25 (with brake)	8.55 (with brake)	
Pole pair number	4	4	4	4	4	
Maximum voltage rising du/dt (KV/ μ s)	8	8	8	8	8	
Insulation class	F	F	F	F	F	
Maximum radial force F (N)	630	630	630	630	630	
Maximum axial force F (N)	315	315	315	315	315	
Weight G (Kg)	6.2	6.2	7.2	7.2	8.2	
	8.2 (with brake)	8.2 (with brake)	9.2 (with brake)	9.2 (with brake)	10.2 (with brake)	
Length of motor L (mm)	168	168	185	185	202	
	228±1 (with brake)	228±1 (with brake)	245±1 (with brake)	245±1 (with brake)	262±1 (with brake)	
Position feedback device	Incremental encoder 2500ppr					
Cooling method	Totally enclosed, non-ventilated					
Protection level	IP65 for body, shaft sealing IP54					
Environmental conditions for operation	Temperature	-20°C ~ 40°C (Non-freezing)				
	Humidity	Below 90% RH (Non-condensing)				
	Ambient environment	Away from active gas, combustible gas, oil drops and dust				
	Altitude	Maximum altitude 4000m, Rated power at 1000m or below, Above 1000m: Decreasing 1.5% per 100m rise				

Note : □=A —Without brake
 □=B —With brake

Technical Specifications of SMH Servo Motor

Technical Specifications of SMH Servo Motor

Technical Specifications of SMH Servo Motor (3)

Motor series	Medium inertia flange size 130mm				Medium inertia flange size 150mm
Model	SMH130D-0105 -20A□K-4HKC	SMH130D-0157 -20A□K-4HKC	SMH130D-0210 -20A□K-4HKC	SMH130D-0300 -20A□K-4HKC	SMH150D-0230 -20A□K-4HKC
Driver matching	JD430-AA-000 FD432S-CA-000 FD432S-AA-000 FD432S-LA-000 CD432S-AA-000	JD620-AA-000 FD622S-CA-000 FD622S-AA-000 FD622S-LA-000	JD620-AA-000 FD622S-CA-000 FD622S-AA-000 FD622S-LA-000	JD630-AA-000 JD630-LA-000	JD620-AA-000 FD622S-CA-000 FD622S-AA-000 FD622S-LA-000
DC link voltage UDC	560	560	560	560	560
Continuous performance	Rated power P_n (W)	1050	1570	2100	3000
	Rated torque T_n (Nm)	5	7.5	10	14.3
	Rated speed n_n (rpm)	2000	2000	2000	2000
	Rated current I_N (A)	4.3	6.3	7.6	7.9
Maximum torque T_m (Nm)	12.5	18.75	25	35.75	27.5
Maximum current I_m (A)	10.75	15.75	19	19.75	17.75
Standstill torque T_s (Nm)	5.5	8.25	11	15.73	12.1
Standstill current I_S (A)	4.73	6.93	8.36	8.7	7.81
Resistance line-line R_L (Ω)	1.85	1.17	0.98	0.84	2.2
Inductance line-line L_L (mH)	23.7	16.2	14.3	12.7	14(AVG)
Electrical time constant τ_e (ms)	12.81	13.846	14.592	14.94	6.36
Mechanical time constant τ_m (ms)	2.868	2.529	2.268	1.53	4.68
Reverse voltage constant K_e (V/krpm)	70	72	80	110	100
Torque constant K_t (Nm/A)	1.1578	1.191	1.3232	1.82	1.65
Rotor moment of inertia J_m (Kg-cm ²)	12	17.7	23.4	34.8	33.5
	12.04 (with brake)	17.74 (with brake)	23.44 (with brake)	34.9 (with brake)	33.6 (with brake)
Pole pair number	4	4	4	4	4
Maximum voltage rising du/dt (KV/ μ s)	8	8	8	8	8
Insulation class	F	F	F	F	F
Maximum radial force F (N)	900	900	900	900	1200
Maximum axial force F (N)	450	450	450	450	600
Weight G (Kg)	7.5	9.1	10.7	13.9	12
	9.7 (with brake)	11.3 (with brake)	12.9 (with brake)	14.9 (with brake)	15.5 (with brake)
Length of motor L (mm)	159±1.5	179±1.5	199±1.5	239±1.5	226±1.5
	220±1.5 (with brake)	240±1.5 (with brake)	260±1.5 (with brake)	280±1.5 (with brake)	292±1.5 (with brake)
Position feedback device	Incremental encoder 2500ppr				
Cooling method	Totally enclosed, non-ventilated				
Protection level	IP65 for body, shaft sealing IP54				
Environmental conditions for operation	Temperature	-20°C ~ 40°C (Non-freezing)			
	Humidity	Below 90% RH (Non-condensing)			
	Ambient environment	Away from active gas, combustible gas, oil drops and dust			
	Altitude	Maximum altitude 4000m, Rated power at 1000m or below, Above 1000m: Decreasing 1.5% per 100m rise			

Note : □=A —Without brake
 □=B —With brake

Technical Specifications of SMH Servo Motor (4)

Motor series	Medium inertia flange size 150mm		Medium inertia flange size 180mm			
Model	SMH150D-0300 -20A□K-4HKC	SMH150D-0380 -20A□K-4HKC	SMH180D-0350 -15A□K-4HKC	SMH180D-0440 -15A□K-4HKC	SMH180D-0550 -15R□K-4HKC	SMH180D-0750 -15R□K-4HKC
Driver matching	JD630-AA-000 JD630-LA-000		JD630-LA-000 JD630-AA-000	JD640-LA-000 JD640-AA-000	JD640-AR-000	JD650-AR-000
DC link voltage UDC	560	560	560	560	560	560
Continuous performance	Rated power P_n (W)	3000	3800	3500	4400	5500
	Rated torque T_n (Nm)	14.3	18	22	28	35
	Rated speed n_n (rpm)	2000	2000	1500	1500	1500
	Rated current I_N (A)	8.5	9.3	10.3	11.9	13.5(REF)
Maximum torque T_m (Nm)	35.75	45	55	70	87.5	
Maximum current I_m (A)	21.25	23.25	25.75	29.75	33.7(REF)	
Standstill torque T_s (Nm)	15.73	19.8	24.2	30.8	38.5	
Standstill current I_S (A)	9.35	10.23	11.33	13.09	14.8(REF)	
Resistance line-line R_L (Ω)	1.4	1.3	1.2	0.65	0.53	
Inductance line-line L_L (mH)	10.6(AVG)	10.5(AVG)	12.7(AVG)	8.5	7.86	
Electrical time constant τ_e (ms)	7.57	8.08	10.58	13.08	14.83	
Mechanical time constant τ_m (ms)	3.68	3.32	3.42	2.16	1.9	
Reverse voltage constant K_e (V/krpm)	107	125	135	150	165	
Torque constant K_t (Nm/A)	1.77	2.07	2.23	2.48	2.73	
Rotor moment of inertia J_m (Kg-cm ²)	47.6	63.1	82	118	154	
	47.7 (with brake)	63.2 (with brake)	82.2 (with brake)	118.2 (with brake)	154.3 (with brake)	
Pole pair number	4	4	4	4	4	
Maximum voltage rising du/dt (KV/ μ s)	8	8	8	8	8	
Insulation class	F	F	F	F	F	
Maximum radial force F (N)	1200	1200	1600	1600	1600	
Maximum axial force F (N)	600	600	800	800	800	
Weight G (Kg)	15	18	22.7	28.6	34.4	
	18.5 (with brake)	22.5 (with brake)	27.9 (with brake)	33.8 (with brake)	41.4	
Length of motor L (mm)	254±1.5	282±1.5	260±1.5	298±1.5	336±1.5	
	320±1.5 (with brake)	352±1.5 (with brake)	332±1.5 (with brake)	370±1.5 (with brake)	413±1.5 (with brake)	
Position feedback device	Incremental encoder 2500ppr				SMT37 Resolver	
Cooling method	Totally enclosed, non-ventilated					
Protection level	IP65 for body, shaft sealing IP54					
Environmental conditions for operation	Temperature	-20°C ~ 40°C (Non-freezing)				
	Humidity	Below 90% RH (Non-condensing)				
	Ambient environment	Away from active gas, combustible gas, oil drops and dust				
	Altitude	Maximum altitude 4000m, Rated power at 1000m or below, Above 1000m: Decreasing 1.5% per 100m rise				

Note : □=A —Without brake
 □=B —With brake

Technical Specifications of Low-voltage Servo Motor

Technical Specifications of Multi-pole Servo Motor

Technical Specifications of Low-voltage Servo Motor

Motor series	Low-voltage SMH Series		Low-voltage SME Series		
	Small inertia flange size 40mm		Small inertia flange size 60mm		Small inertia flange size 80mm
Model	SMH40S-0005-30A □K-4DKH	SMH40S-0010-30A □K-4DKH	SME60S-0020-30A □K-3DKH	SME60S-0040-30A □K-3DKH	SME80S-0040-30A □K-3DKH
Driver matching	FD122-CA-000		FD122-AA-000	FD122-LA-000	
DC link voltage UDC	60	60	48	48	48
Continuous performance	Rated power P_n (W)	50	100	200	400
	Rated torque T_n (Nm)	0.16	0.32	0.64	1.27
	Rated speed n_n (rpm)	3000	3000	3000	3000
	Rated current I_N (A)	1.2	2.5	4.6	10
Maximum torque T_m (Nm)	0.48	0.96	1.92	3.18	3.18
Maximum current I_m (A)	3.6	7.5	13.8	25	24
Standstill torque T_s (Nm)	0.176	0.352	0.7	1.4	1.4
Standstill current I_S (A)	1.32	2.75	5.06	11	10.6
Resistance line-line R_L (Ω)	4.2	2.1	1.1	0.42	0.22
Inductance line-line L_L (mH)	3.5	2.5	2.4	0.79	1
Electrical time constant τ_e (ms)	0.84	1.2	2.18	1.88	4.55
Mechanical time constant τ_m (ms)	1.28	1.22	3.22	1.84	1.65
Reverse voltage constant K_e (V/krpm)	8	8	9	8	8
Torque constant K_t (Nm/A)	0.1323	0.1323	0.149	0.13232	0.13232
Rotor moment of inertia J_m (Kg·cm ²)	0.031	0.059	0.375	0.443	0.76
	0.033 (with brake)	0.061 (with brake)	0.375 (with brake)	0.447 (with brake)	0.77 (with brake)
Pole pair number	4	4	3	3	3
Maximum voltage rising du/dt (KV/ μ s)	8	8	8	8	8
Insulation class	F	F	F	F	F
Maximum radial force F (N)	120	120	180	180	180
Maximum axial force F (N)	60	60	90	90	90
Weight G (Kg)	0.5	0.8	1.3	1.6	2.5
	0.8 (with brake)	1.0 (with brake)	1.8 (with brake)	2.1 (with brake)	3.2 (with brake)
Length of motor L (mm)	85.3±1	110.8±1	120 ± 1.5	135 ± 1.5	117 ± 1.5
	119±1.5 (with brake)	145±1.5 (with brake)	159±1.5 (with brake)	174±1.5 (with brake)	167±1.5 (with brake)
Position feedback device	Incremental encoder 2500ppr				
Cooling method	Totally enclosed, non-ventilated				
Protection level	IP65 for body, shaft sealing IP54				
Environmental conditions for operation	Temperature	-20°C ~ 40°C (Non-freezing)			
	Humidity	Below 90% RH (Non-condensing)			
	Ambient environment	Away from active gas, combustible gas, oil drops and dust			
	Altitude	Maximum altitude 4000m, Rated power at 1000m or below, Above 1000m: Decreasing 1.5% per 100m rise			

Note : □=A —Without brake
 □=B —With brake

Technical Specifications of Multi-pole Servo Motor

Motor series	Small inertia flange size 57mm		Small inertia flange size 85mm				
	Model	57S-0010-10AAK-FDFH	57S-0015-08AAK-FDFH	85S-0020-05AAK-FLFN-02	85S-0025-05AAK-FLFN-02	85S-0035-05AAK-FLFN-02	85S-0045-05AAK-FLFN-02
Driver matching	FD122-CA-000 FD122-AA-000 FD122-LA-000		JD430-AA-000 FD422S-CA-000 FD422S-AA-000 FD422S-LA-000		CD422S-AA-000		FD122-CA-000 FD122-AA-000 FD122-LA-000
Rated phase current (A)	6.5	5.8	6	4	4	4	8.5
Holding torque (Nm)	0.9	1.5	2.4	4.18	6	7.5	7.5
Damping torque (Nm)	0.04	0.068	0.25	0.3	0.4	0.45	0.45
Resistance line-line (Ω)	0.35	0.7	0.44	1.13	2.3	1.78	0.43
Inductance line-line(mH)	1.28	2.4	3	5.75	12.4	17.1	3.9
Motor moment of inertia(Kg·cm ²)	0.03	0.048	0.14	0.232	0.33	0.44	0.44
Length L (mm)	90±1.5	113±1.5	125±1	142±1	172±1	202±1	202±1
Maximum radial force(N)	15	15	60	60	60	60	60
Maximum axial force (N)	75	75	220	220	220	220	220
Weight (Kg)	1.05	1.3	2.3	2.7	3.8	5.3	5.3
Dielectric strength	600V AC 1S 5mA	600V AC 1S 5mA	1200V AC 1S 2mA	1500V AC 1S 5mA			1800V AC 1S 5mA
Insulation class	B						
Ambient temperature	-20 ~ 50°C						
Surface temperature rising	Max. 80°C						
Insulation impedance	Min. 100M Ω , 500V DC						

Technical Specifications of SMC Servo Motor

Motor series	Small inertia flange size 60mm		Small inertia flange size 80mm
Model	SMC60S-0020-30E□K-3LKH	SMC60S-0040-30E□K-3LKH	SMC80S-0075-30E□K-3LKH
Driver matching	FD422S-CA-000 FD422S-AA-000 FD422S-LA-000 CD422S-AA-000		
DC link voltage UDC	300	300	300
Continuous performance	Rated power P_n (W)	200	400
	Rated torque T_n (Nm)	0.64	1.24
	Rated speed n_n (rpm)	3000	3000
	Rated current I_n (A)	1.4	2.4
Maximum torque T_m (Nm)	1.92	3.81	7.17
Maximum current I_m (A)	4.2	7.2	11.4
Standstill torque T_s (Nm)	0.7	1.4	2.63
Standstill current I_s (A)	1.5	2.6	4.2
Resistance line-line R (Ω)	11.2	5.8	2.1
Inductance line-line L (mH)	20.9	11.5	10.5
Electrical time constant τ_e (ms)	1.87	1.98	5
Mechanical time constant τ_m (ms)	1.8	1.29	0.9
Reverse voltage constant K_r (V/krpm)	29	34	40
Torque constant K_t (Nm/A)	0.48	0.563	0.662
Rotor moment of inertia J_m (Kg-cm ²)	0.214	0.405	1.087
	0.218 (with brake)	0.409 (with brake)	1.099 (with brake)
Pole pair number	3	3	3
Maximum voltage rising du/dt (KV/ μ s)	8	8	8
Insulation class	F	F	F
Maximum radial force F (N)	180	180	335
Maximum axial force F (N)	90	90	167.5
Weight G (Kg)	1.1	1.6	2.8
	1.6 (with brake)	2.1 (with brake)	3.4 (with brake)
Length of motor L (mm)	109±1.5	135±1.5	139±1.5
	150±1.5 (with brake)	176±1.5 (with brake)	182±1.5 (with brake)
Position feedback device	Incremental encoder 2500ppr		
Cooling method	Totally enclosed, non-ventilated		
Protection level	IP65 for body, shaft sealing IP54		
Environmental conditions for operation	Temperature	-20°C ~ 40°C (Non-freezing)	
	Humidity	Below 90% RH (Non-condensing)	
	Ambient environment	Away from active gas, combustible gas, oil drops and dust	
	Altitude	Maximum altitude 4000m, Rated power at 1000m or below, Above 1000m: Decreasing 1.5% per 100m rise	

Note : □=A —Without brake
 □=B —With brake

Technical Specifications of SMS Servo Motor

Motor series	Medium inertia flange size 130mm		
Model	SMC130D-0100-20E□K-4LKP	SMC130D-0150-20E□K-4LKP	SMC130D-0200-20E□K-4LKP
Driver matching	FD422S-CF-000 FD422S-AF-000 FD422S-LF-000 CD422S-AF-000	FD432S-CA-000 FD432S-AA-000 FD432S-LA-000 CD432S-AA-000	
DC link voltage UDC	300	300	300
Continuous performance	Rated power P_n (W)	1000	1500
	Rated torque T_n (Nm)	4.8	7.2
	Rated speed n_n (rpm)	2000	2000
	Rated current I_n (A)	4.2(REF)	6.5(REF)
Maximum torque T_m (Nm)	12	18	25
Maximum current I_m (A)	10.4(REF)	16.2(REF)	21.1(REF)
Standstill torque T_s (Nm)	5.28	7.92	11
Standstill current I_s (A)	4.6(REF)	7.1(REF)	9.3(REF)
Resistance line-line R (Ω)	3.1	1.53	0.93
Inductance line-line L (mH)	22.7	13.3	8.8
Electrical time constant τ_e (ms)	7.32	8.69	9.46
Mechanical time constant τ_m (ms)	2.72	2.31	1.85
Reverse voltage constant K_r (V/krpm)	73	71	75
Torque constant K_t (Nm/A)	1.21	1.17	1.24
Rotor moment of inertia J_m (Kg-cm ²)	7.4	12	17.7
	7.5 (with brake)	12.1 (with brake)	17.8 (with brake)
Pole pair number	4	4	4
Maximum voltage rising du/dt (KV/ μ s)	8	8	8
Insulation class	F	F	F
Maximum radial force F (N)	900	900	900
Maximum axial force F (N)	450	450	450
Weight G (Kg)	6.2	7.5	9.1
	8.5 (with brake)	9.8 (with brake)	11.4 (with brake)
Length of motor L (mm)	143±1.5	159±1.5	179±1.5
	204±1.5 (with brake)	220±1.5 (with brake)	240±1.5 (with brake)
Position feedback device	Incremental encoder 2500ppr		
Cooling method	Totally enclosed, non-ventilated		
Protection level	IP65 for body, shaft sealing IP54		
Environmental conditions for operation	Temperature	-20°C ~ 40°C (Non-freezing)	
	Humidity	Below 90% RH (Non-condensing)	
	Ambient environment	Away from active gas, combustible gas, oil drops and dust	
	Altitude	Maximum altitude 4000m, Rated power at 1000m or below, Above 1000m: Decreasing 1.5% per 100m rise	

Note : □=A —Without brake
 □=B —With brake

Technical Specifications of SMC Servo Motor

Motor series	Medium inertia flange size 130mm			
Model	SMC130D-0150 -20E□K-4HKP	SMC130D-0200 -20E□K-4HKP	SMC130D-0300 -20E□K-4HKP	SMC130D-0300 -30E□K-4HKP
Driver matching	FD612S-CA-000 FD612S-AA-000 FD612S-LA-000 CD612S-AA-000		FD622S-CA-000 FD622S-AA-000 FD622S-LA-000 CD622S-AA-000	
DC link voltage UDC	560	560	560	560
Continuous performance	Rated power P_n (W)	1500	2000	3000
	Rated torque T_n (Nm)	7.2	10	14.3
	Rated speed n_n (rpm)	2000	2000	2000
	Rated current I_n (A)	4.3(REF)	6.2(REF)	6.5(REF)
Maximum torque T_m (Nm)	18	25	35.75	25
Maximum current I_m (A)	10.8(REF)	15.5(REF)	16.3(REF)	15.9(REF)
Standstill torque T_s (Nm)	7.92	11	15.73	11
Standstill current I_s (A)	4.8(REF)	6.8(REF)	7.2(REF)	7(REF)
Resistance line-line R (Ω)	3.6	1.79	1.77	1.23
Inductance line-line L (mH)	29.6	16.3	18.2	12.1
Electrical time constant τ_e (ms)	8.22	9.11	10.28	9.84
Mechanical time constant τ_m (ms)	2.44	1.92	1.69	1.83
Reverse voltage constant K_r (V/krpm)	106	102	139	100
Torque constant K_t (Nm/A)	1.75	1.69	2.3	1.65
Rotor moment of inertia J_m (Kg-cm ²)	12	17.7	29.1	23.4
	12.1 (with brake)	17.8 (with brake)	29.2 (with brake)	23.5 (with brake)
Pole pair number	4	4	4	4
Maximum voltage rising du/dt (KV/ μ s)	8	8	8	8
Insulation class	F	F	F	F
Maximum radial force F (N)	900	900	900	900
Maximum axial force F (N)	450	450	450	450
Weight G (Kg)	7.5	9.1	12.3	10.7
	9.8 (with brake)	11.4 (with brake)	14.9 (with brake)	13 (with brake)
Length of motor L (mm)	159±1.5	179±1.5	219±1.5	199±1.5
	220±1.5 (with brake)	240±1.5 (with brake)	280±1.5 (with brake)	260±1.5 (with brake)
Position feedback device	Incremental encoder 2500ppr			
Cooling method	Totally enclosed, non-ventilated			
Protection level	IP65 for body, shaft sealing IP54			
Environmental conditions for operation	Temperature	-20°C ~ 40°C (Non-freezing)		
	Humidity	Below 90% RH (Non-condensing)		
	Ambient environment	Away from active gas, combustible gas, oil drops and dust		
	Altitude	Maximum altitude 4000m, Rated power at 1000m or below, Above 1000m: Decreasing 1.5% per 100m rise		

Note : □=A — Without brake
□=B — With brake

Technical Specifications of SMS Servo Motor

Motor series	Small inertia flange size 60mm		Small inertia flange size 80mm
Model	SMS60S-0020-30□AK-3LKU	SMS60S-0040-30□K-3LKU	SMS80S-0075-30□K-3LKU
Driver matching	FD422S-CA-000 FD422S-AA-000 FD422S-LA-000 CD422S-AA-000		
DC link voltage UDC	300	300	300
Continuous performance	Rated power P_n (W)	200	400
	Rated torque T_n (Nm)	0.64	1.27
	Rated speed n_n (rpm)	3000	3000
	Rated current I_n (A)	1.4	2.4
Maximum torque T_m (Nm)	1.92	3.81	7.17
Maximum current I_m (A)	4.2	7.2	11.4
Standstill torque T_s (Nm)	0.7	1.4	2.63
Standstill current I_s (A)	1.5	2.6	4.2
Resistance line-line R (Ω)	11.2	5.8	2.1
Inductance line-line L (mH)	20.9	11.5	10.5
Electrical time constant τ_e (ms)	1.87	1.98	5
Mechanical time constant τ_m (ms)	1.8	1.29	0.9
Reverse voltage constant K_r (V/krpm)	29	34	40
Torque constant K_t (Nm/A)	0.48	0.563	0.662
Rotor moment of inertia J_m (Kg-cm ²)	0.214	0.405	1.087
	0.218 (with brake)	0.409 (with brake)	1.099 (with brake)
Pole pair number	3	3	3
Maximum voltage rising du/dt (KV/ μ s)	8	8	8
Insulation class	F	F	F
Maximum radial force F (N)	180	180	335
Maximum axial force F (N)	90	90	167.5
Weight G (Kg)	1.1	1.6	2.8
	1.6 (with brake)	2.1 (with brake)	3.4 (with brake)
Length of motor L (mm)	94±1.5	115±1.5	132±1.5
	133±1.5 (with brake)	154±1.5 (with brake)	182±1.5 (with brake)
Position feedback device	20 bit single-turn encoder, 16 bit multi-turn absolute encoder		
Cooling method	Totally enclosed, non-ventilated		
Protection level	IP65 for body, shaft sealing IP54		
Environmental conditions for operation	Temperature	-20°C ~ 40°C (Non-freezing)	
	Humidity	Below 90% RH (Non-condensing)	
	Ambient environment	Away from active gas, combustible gas, oil drops and dust	
	Altitude	Maximum altitude 4000m, Rated power at 1000m or below, Above 1000m: Decreasing 1.5% per 100m rise	

Note : □=J — Motor equipped with 20 bit single-turn encoder □=A — Without brake
□=K — Motor equipped with 16 bit multi-turn absolute encoder □=B — With brake

40 flange motor with direct cable

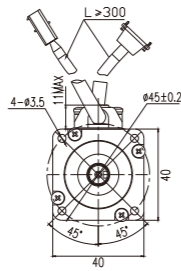
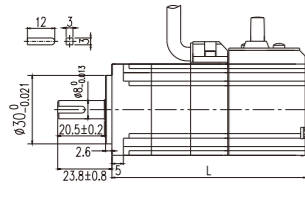

SMH40S-0005-30A □ K-4LKH 50W

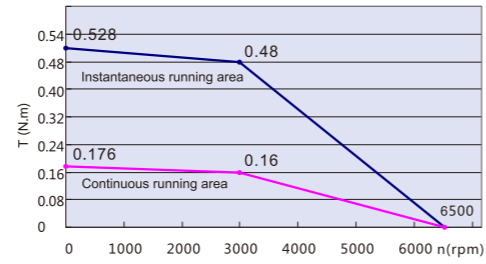

40 flange motor with direct cable and brake

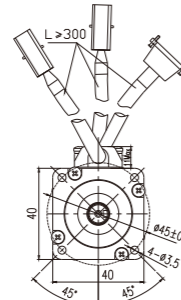
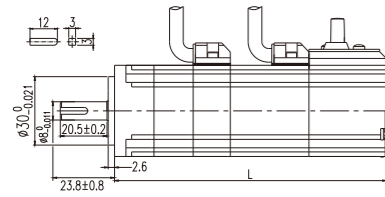

SMH40S-0010-30A □ K-4LKH 100W

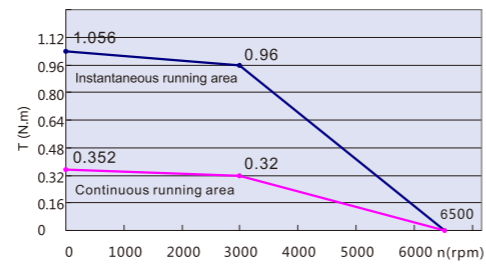

60 flange motor with direct cable

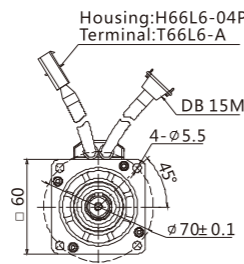
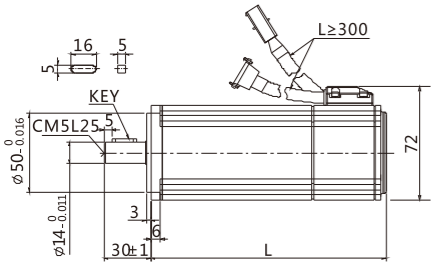

Housing:H66L6-04P
Terminal:T66L6-A

SMH60S-0020-30A □ K-3LK □ 200W

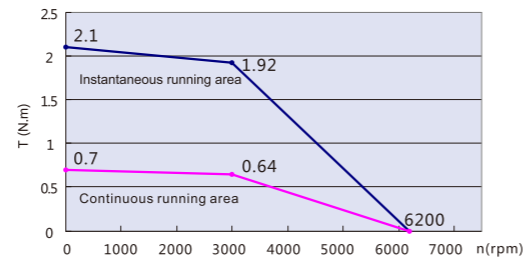

60 flange motor with direct cable and brake

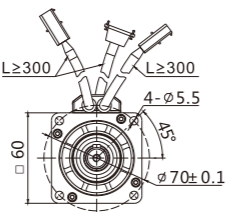
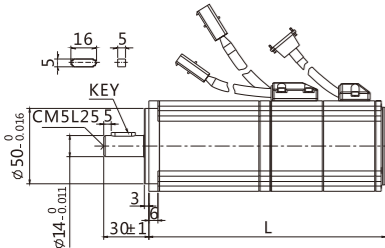

SMH60S-0010-30A □ K-3LK □ 1000W



60 flange motor with HFO standard connector

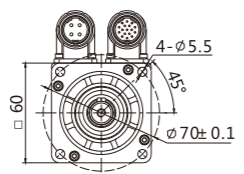
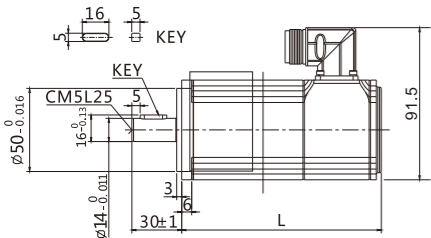

60 flange motor with Intercontec connector

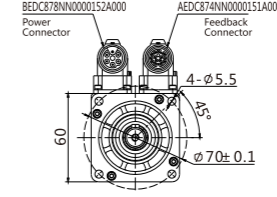
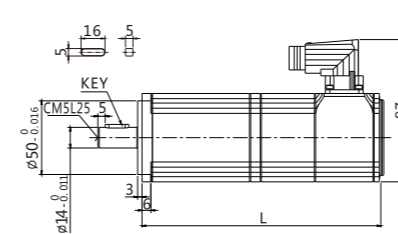

SMH60S-0040-30A □ K-3LK □ 400W

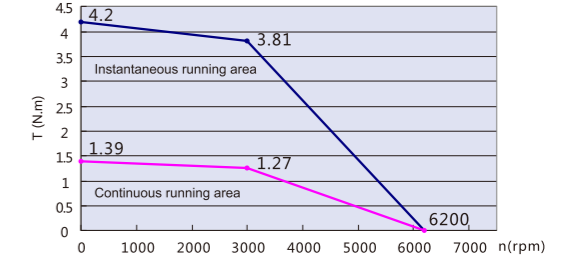

80 flange motor with direct cable

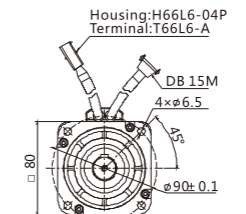
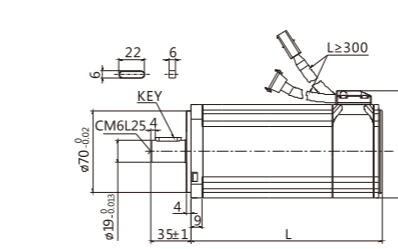

Housing:H66L6-04P
Terminal:T66L6-A

SMH80S-0075-30A □ K-3LK □ 750W

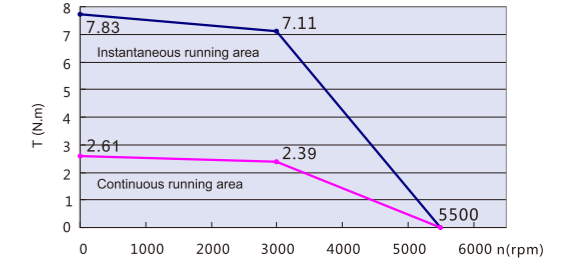

80 flange motor with direct cable and brake

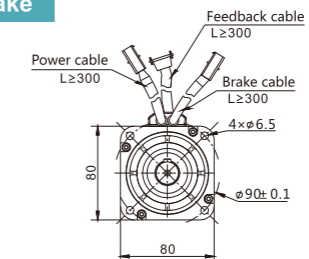
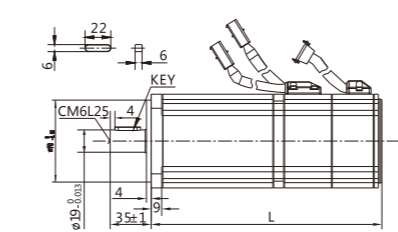

80 flange motor with HFO standard connector

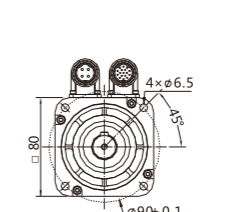
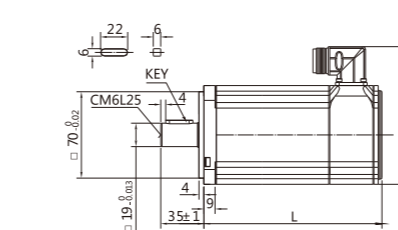

80 flange motor with Intercontec connector

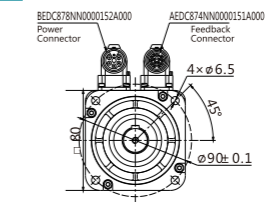
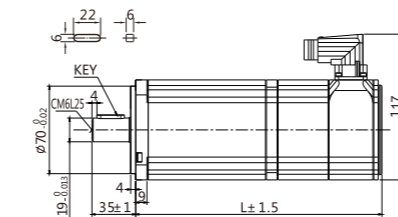

110 flange motor with standard connector

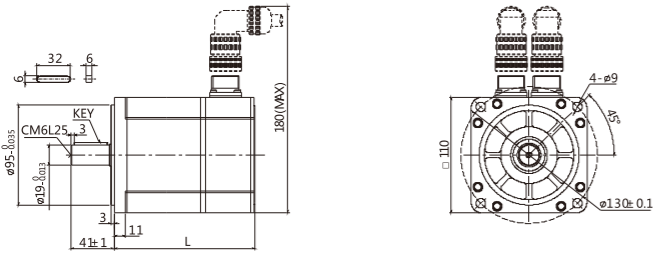

SMH110D-0105-20A □ K-4LKC 1.05KW

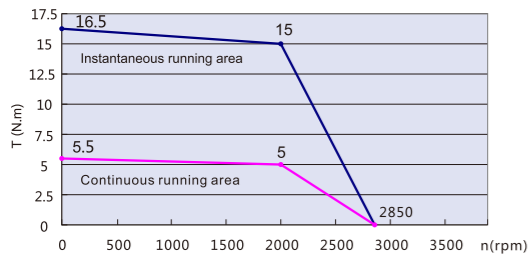

SMH110D-0126-30A □ K-4HKC 1.26KW

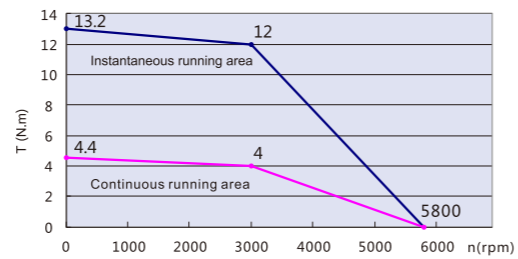

SMH110D-0126-20A □ K-4LKC 1.26KW

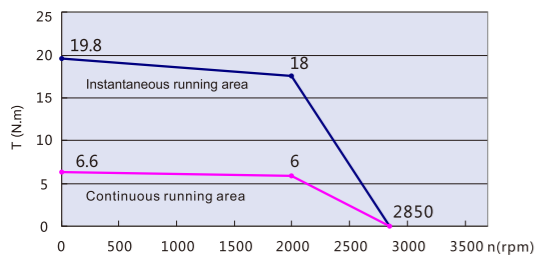

SMH110D-0157-30A □ K-4HKC 1.57KW

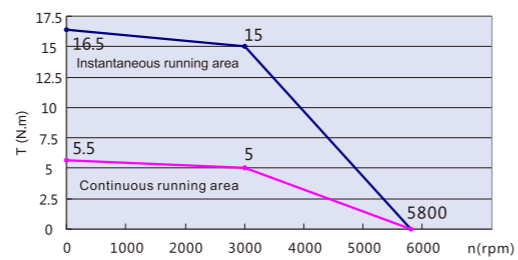

SMH110D-0125-30A □ K-4LKC 1.25KW

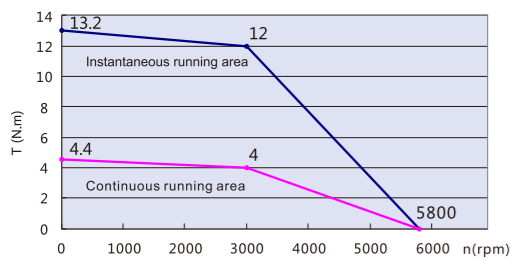

SMH110D-0188-30A □ K-4HKC 1.88KW



130 flange motor with standard connector

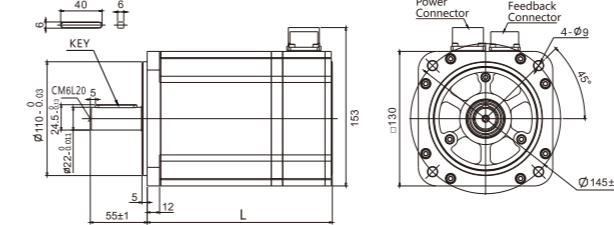

SMH130D-0105-20A □ K-4HKC 1.05KW

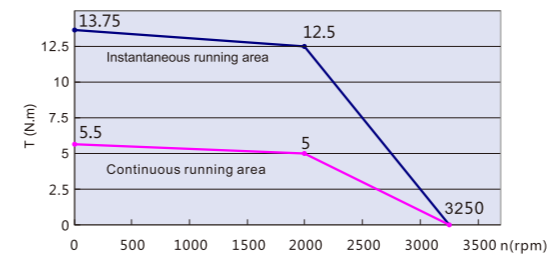

SMH130D-0157-20A □ K-4HKC 1.57KW

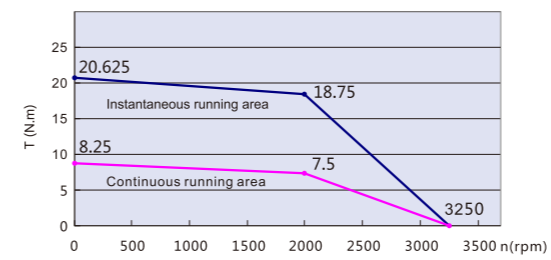

SMH130D-0210-20A □ K-4HKC 2.1KW

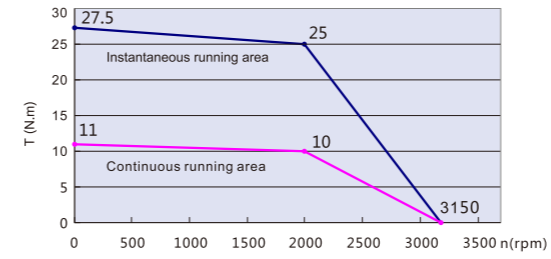

SMH130D-0300-20A □ K-4HKC 3KW

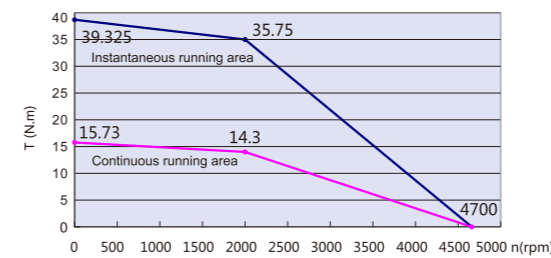

150 flange motor with standard connector

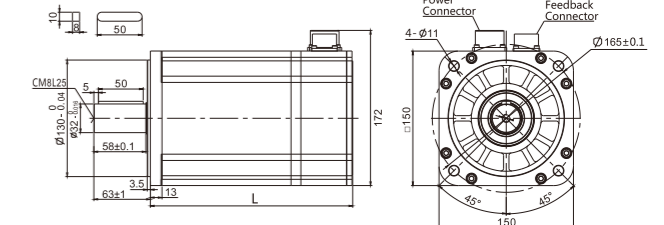

SMH150D-0230-20A □ K-4HKC 2.3KW

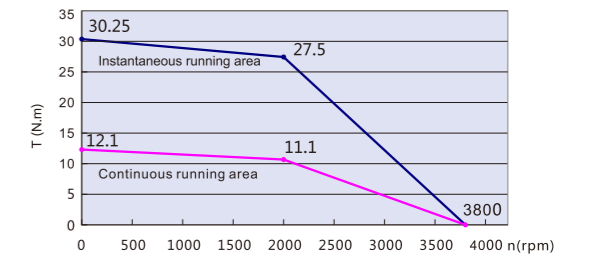

SMH150D-0300-20A □ K-4HKC 3KW

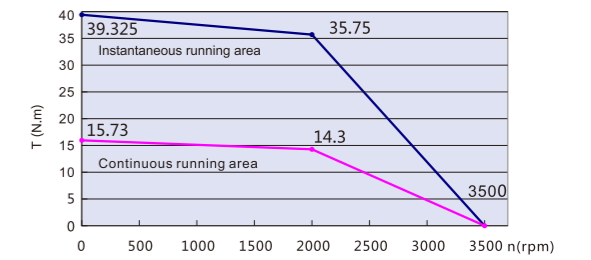

SMH150D-0380-20A □ K-4HKC 3.8KW

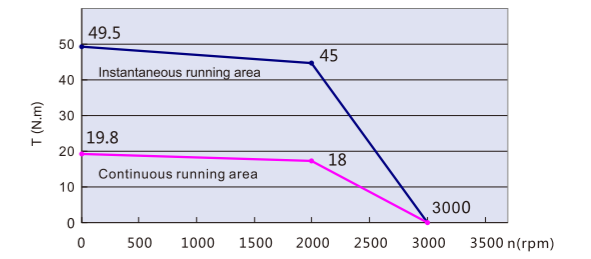

Dimensions/Torque curve of SMH Servo Motor

180 flange motor with standard connector

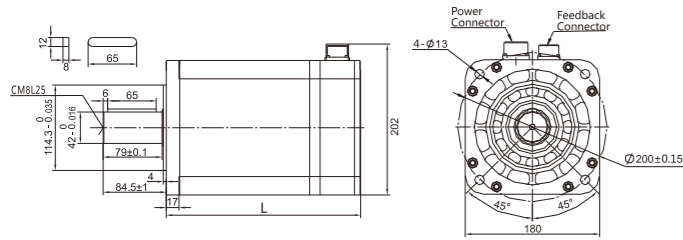

SMH180D-0350-15A □K-4HKC 3.5KW

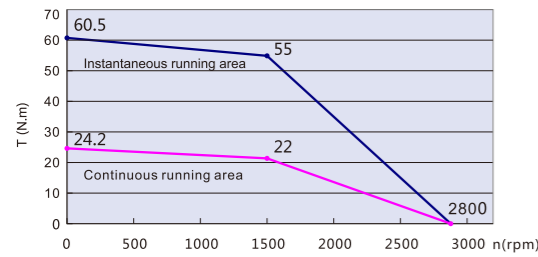

SMH180D-0440-15A □K-4HKC 4.4KW

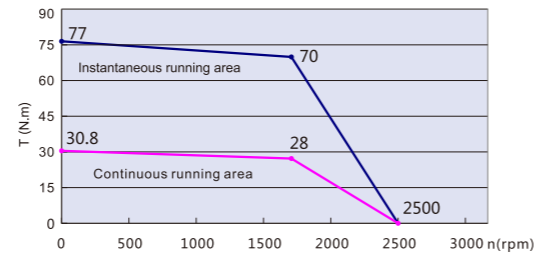

SMH180D-0550-15R □K-4HKC 5.5KW

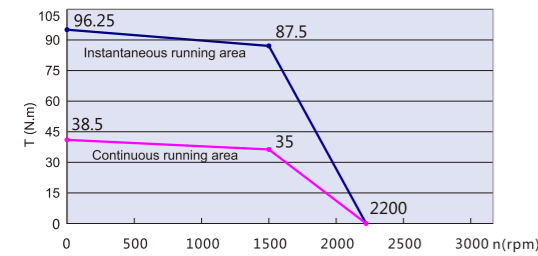

SMH180D-0750-15R □K-4HKC 7.5KW

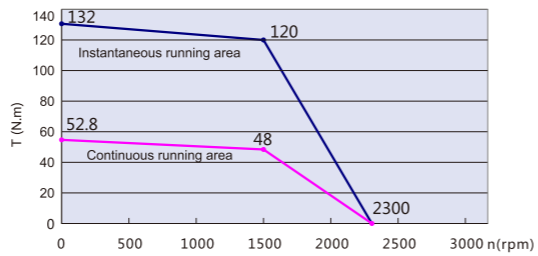

Dimensions/Torque curve of Low-voltage Servo Motor

40 flange SMH low-voltage servo motor with direct cable

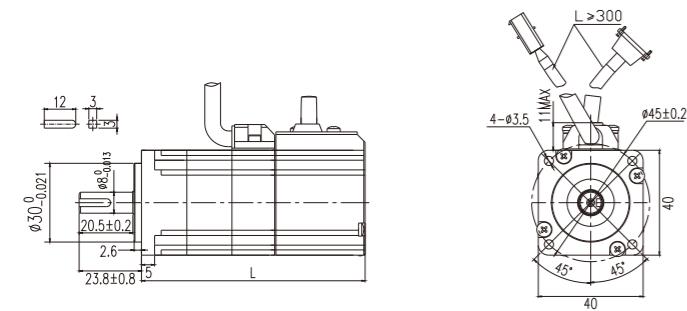

SMH40S-0005-30A □K-4DKH 50W

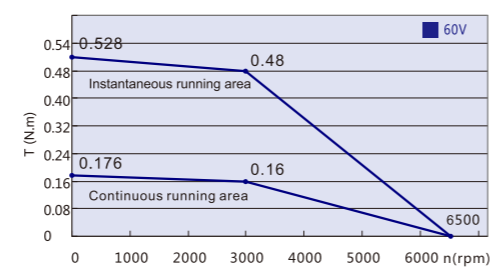

40 flange SMH series low-voltage servo motor with direct cable and brake

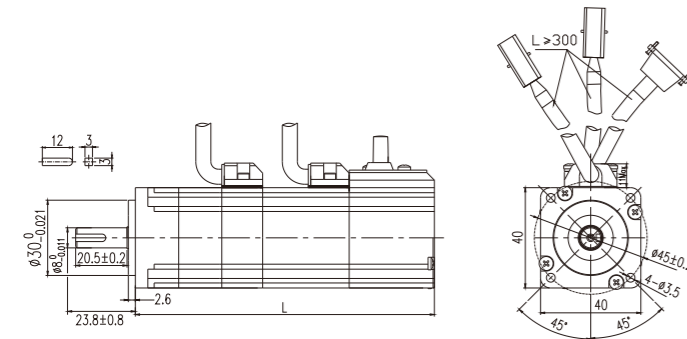

SMH40S-0010-30A □K-4DKH 100W

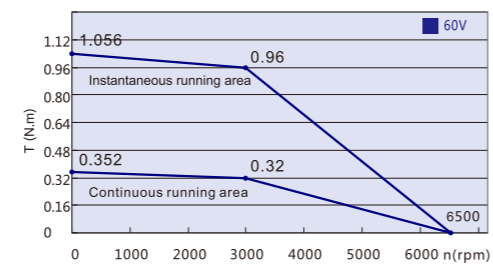

Dimensions/Torque curve of Low-voltage Servo Motor

60 flange SME low-voltage servo motor with direct cable

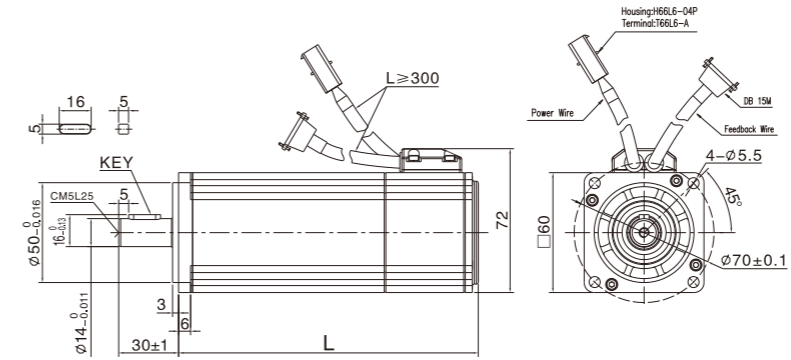

SME60S-0020-30A □K-3DKH 200W

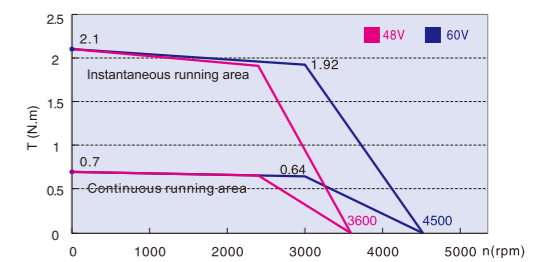

60 flange SME series low-voltage servo motor with direct cable and brake

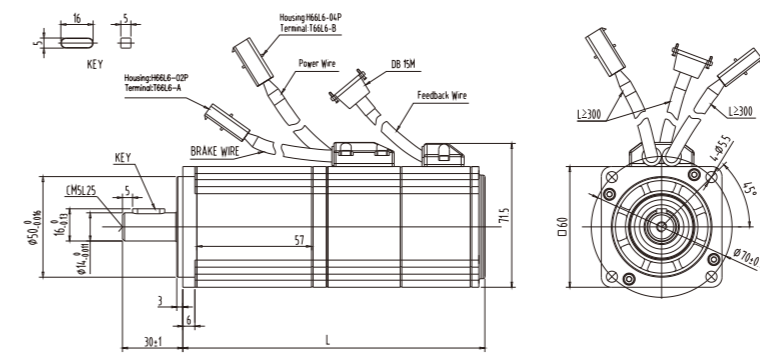

SME60S-0040-30A □K-3DKH 400W

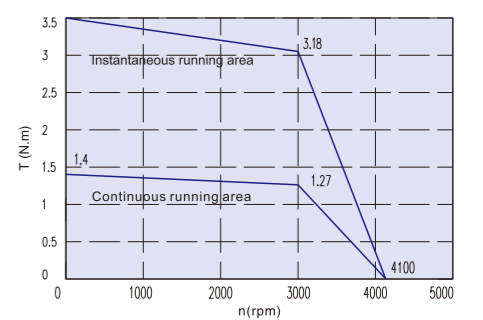

80 flange SME low-voltage servo motor with direct cable

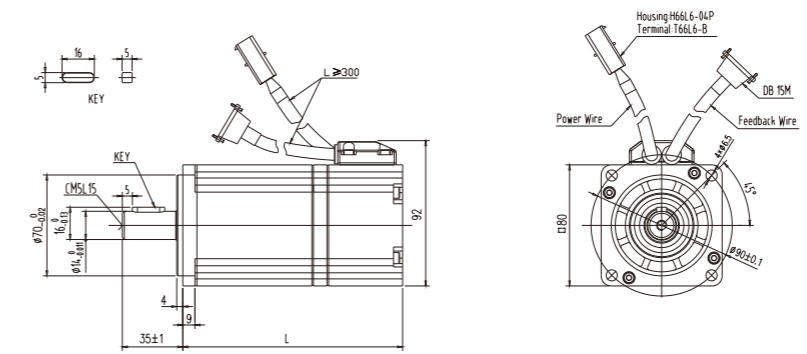

SME80S-0040-30A □K-3DKH 400W

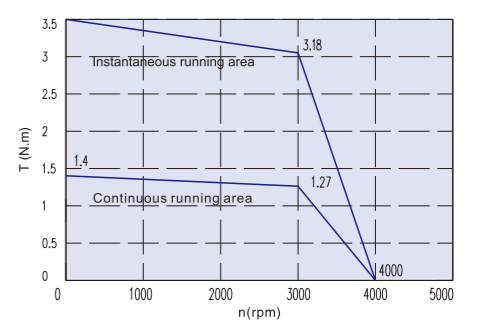

80 flange SME series low-voltage servo motor with direct cable and brake

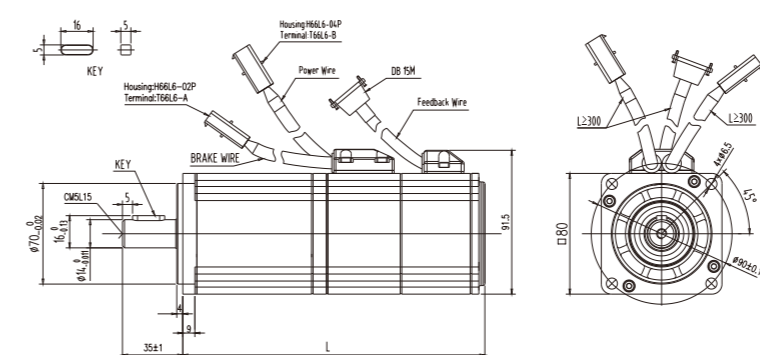

130 flange motor with standard connector

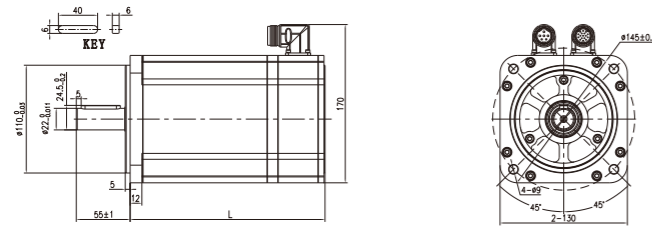

SMC130D-0100-20E K-4LKP

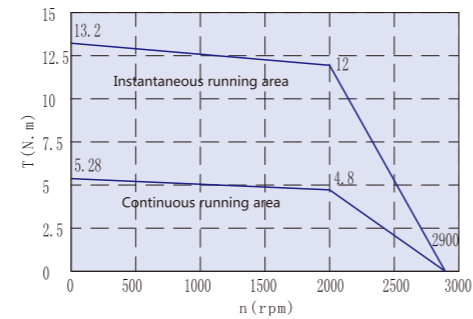

SMC130D-0200-20E K-4LKP

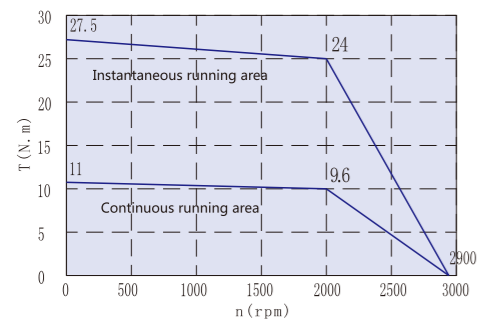

SMC130D-0150-20E K-4HKP

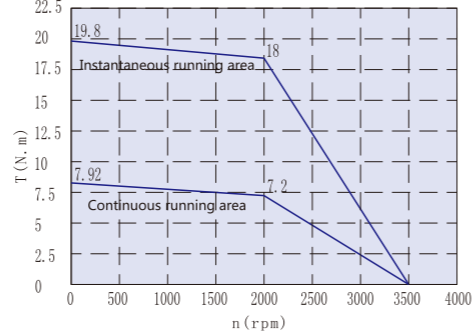

SMC130D-0300-30E K-4HKP

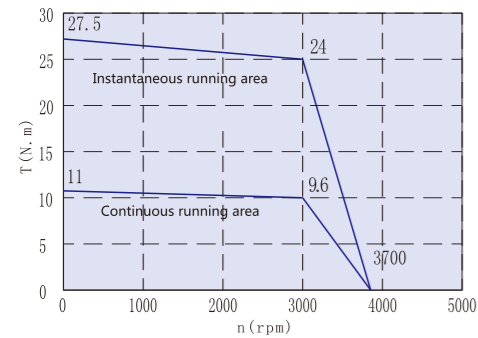

SMC130D-0150-20E K-4LKP

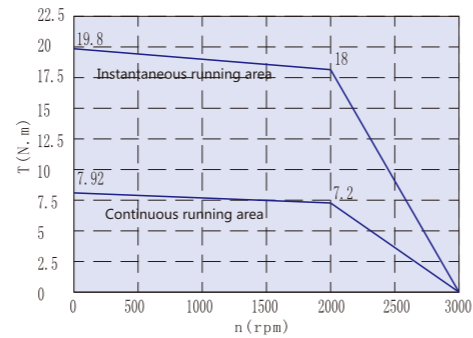

SMC130D-0300-20E K-4HKP

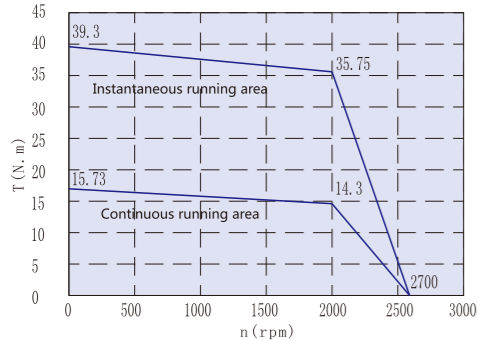

SMC130D-0200-20A K-4HKP

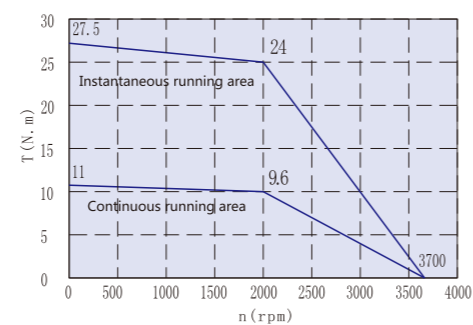

60 flange motor with communication encoder

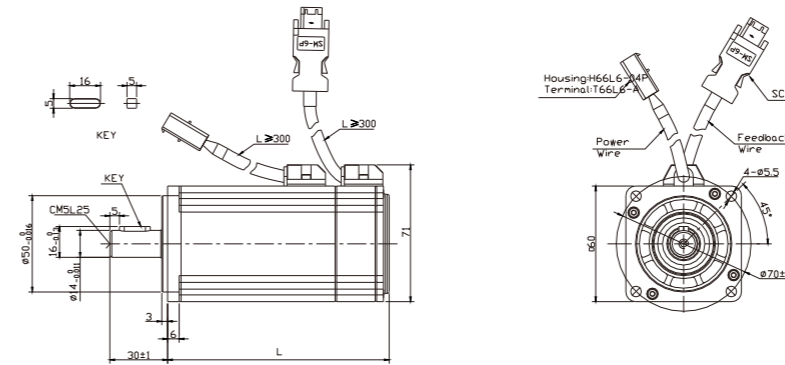

SMS60S-0020-30 AK-3LKU 200W

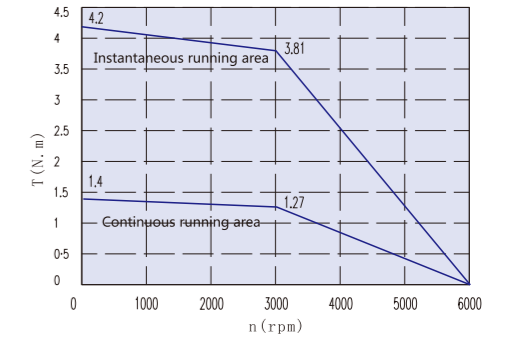

60 flange motor with communication encoder and brake

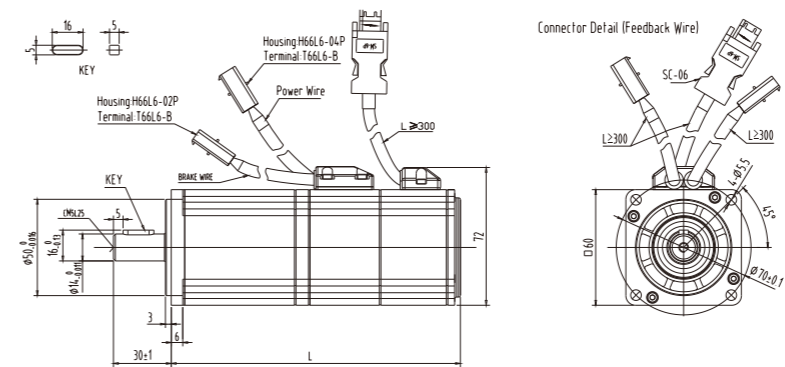

SMS60S-0040-30 K-3LKU 400W

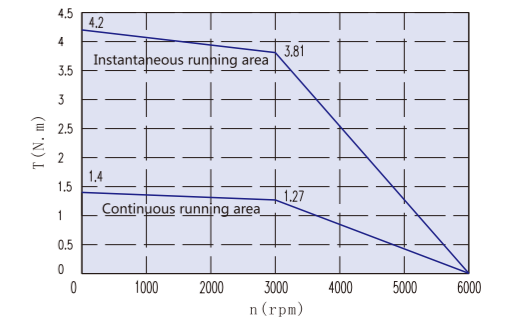

80 flange motor with communication encoder

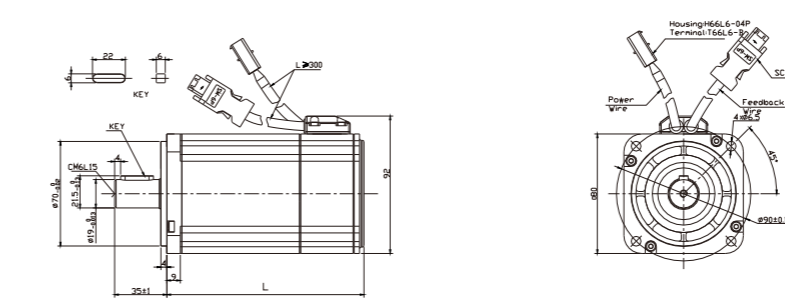

SMS80S-0075-30 K-3LKU 750W

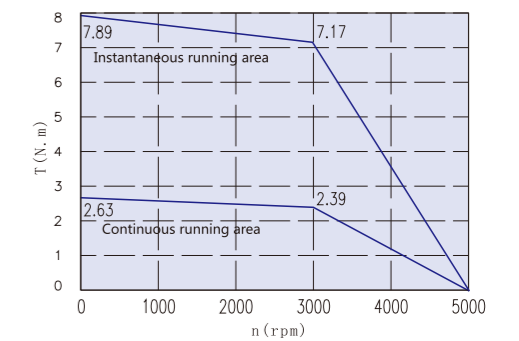

80 flange motor with communication encoder and brake

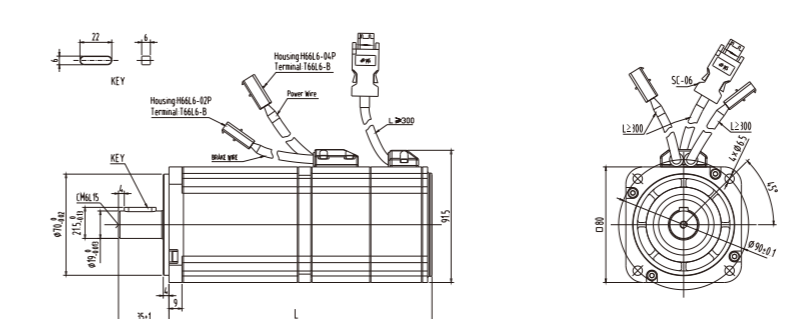

Wiring Diagram for The Power Cable

MOT-005-LL-KL-D

Wire Spec. 4×18AWG(41/0.167)

The sectional area of 18AWG is 0.8107mm²

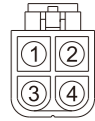

A
4PIN

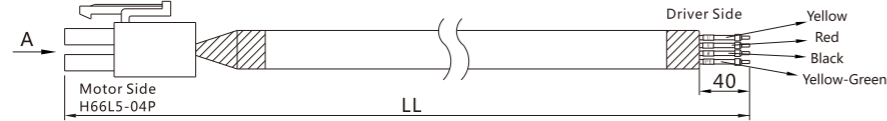

Cable color	Signal	PIN#
Yellow	U	PIN1
Red	V	PIN2
Black	W	PIN3
Yellow-Green	PE	PIN4

MOT-005-LL-KL

Wire Spec. UL20328 4C×18AWG(41/0.16T) black

The sectional area of 18AWG is 0.8107mm²

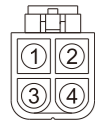

A
4PIN

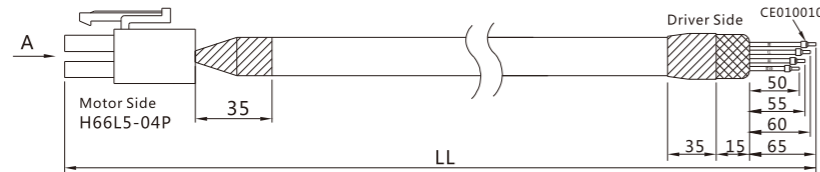

Cable color	Signal	PIN#
Yellow	U	PIN1
Red	V	PIN2
Black	W	PIN3
Yellow-Green	PE	PIN4

MOT-005-LL-KC0

Wire Spec. 4C×18AWG(41/0.16T)

The sectional area of 18AWG is 0.8107mm²

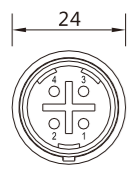

A
4PIN

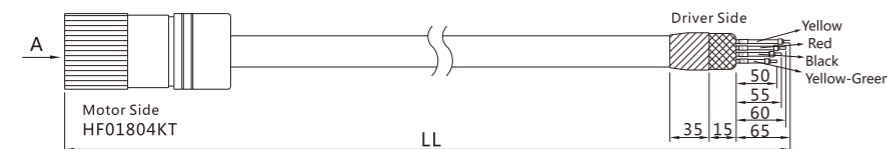

Cable color	Signal	PIN#
Yellow	U	PIN2
Red	V	PIN3
Black	W	PIN4
Yellow-Green	PE	PIN1
Metal ring	Shield	Shield terminal

MOT-005-LL-KC4

Wire Spec. UL20328 4×18AWG

The sectional area of 18AWG is 0.8107mm²

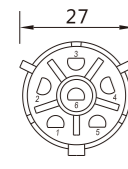

A
6PIN

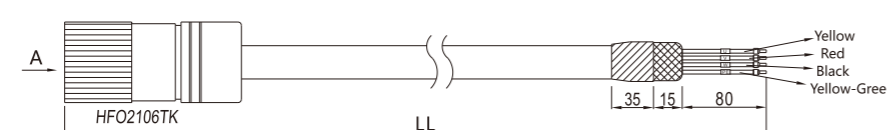

Cable color	Signal	HFO2106TK
Yellow	U	PIN2
Red	V	PIN3
Black	W	PIN4
Yellow-Green	PE	PIN6

Wiring Diagram for The Power Cable

MOT-005-LL-KC4-B

Wire Spec. 4×18AWG+2×20AWG

The sectional area of 18AWG is 0.8107mm²
The sectional area of 20AWG is 0.5189mm²

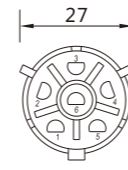

A
6PIN

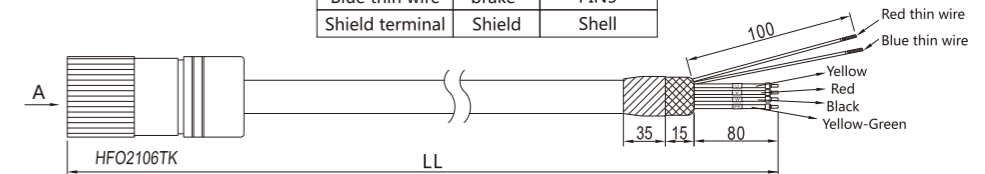

Cable Color	Signal	HFO2106TK
Yellow	U	PIN2
Red	V	PIN3
Black	W	PIN4
Yellow-Green	PE	PIN6
Red thin wire	brake+	PIN1
Blue thin wire	brake-	PIN5
Shield terminal	Shield	Shell

MOTE-005-LL-KC0

Wire Spec. 4C×18AWG(41/0.16T)

The sectional area of 18AWG is 0.8107mm²

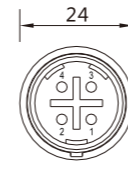

A
4PIN

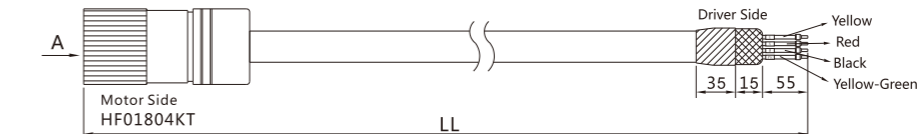

Cable color	Signal	PIN#
Yellow	U	PIN2
Red	V	PIN3
Black	W	PIN4
Yellow-Green	PE	PIN1
Metal ring	Shield	Shield terminal

BRA-LL-KL

Wire Spec. 2×20AWG

The sectional area of 20AWG is 0.5189mm²

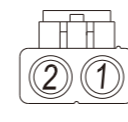

A
2PIN

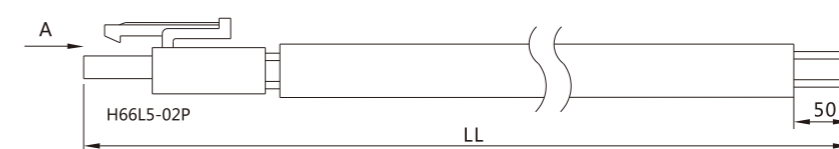

Cable color	Signal	PIN#
Red	break+	PIN1
Blue	break-	PIN2

MOT-005-LL-KM1

Wire Spec. UL20328 4C×18AWG(41/0.16T) black

The sectional area of 18AWG is 0.8107mm²



A



Cable color	Signal	PIN#
Yellow	U	PIN1
Red	V	PIN2
Black	W	PIN3
Yellow-Green	PE	⊥

Wiring Diagram for The Power Cable

MOT-005-LL-KM1-B

Wire Spec. RVVYP 4×18AWG+2×20AWG
The sectional area of 18AWG is 0.8107mm²
The sectional area of 20AWG is 0.5189mm²

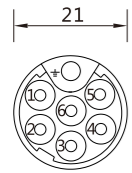

A
7PIN

Cable color	Signal	M17 7PIN
Yellow	U	PIN1
Red	V	PIN2
Black	W	PIN3
Yellow-Green	PE	⊕
Shield terminal	Shield	Metal ring
Red thin wire	brake+	PIN4
Blue thin wire	brake-	PIN5

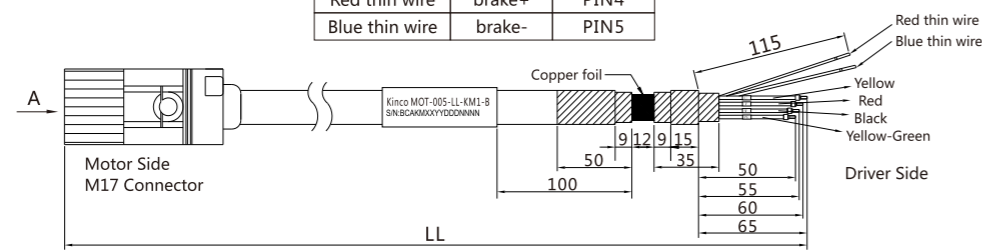

MOT-008-LL-KL-D

Wire Spec. UL2586 4×16AWG
The sectional area of 16AWG is 1.318mm²

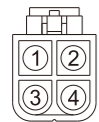

A
H66L5-04P

Cable color	Signal	H66L5-04P
Yellow	U	PIN1
Red	V	PIN2
Black	W	PIN3
Yellow-Green	PE	PIN4

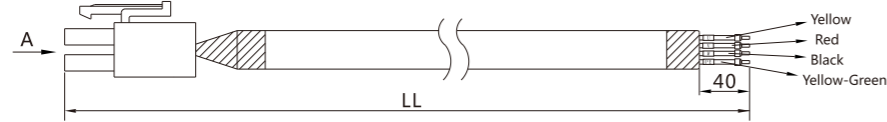

MOT-008-LL-KL

Wire Spec. cable 4C×1.5mm²

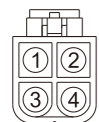

A
4PIN

Cable color	Signal	PIN#
1 Yellow	U	PIN1
2 Red	V	PIN2
3 Black	W	PIN3
Yellow-Green	PE	PIN4

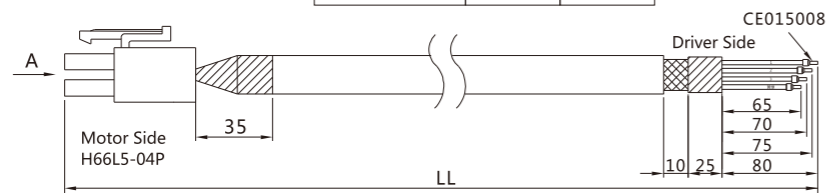

MOT-008-LL-KC0

Wire Spec. ECHU H05VVC4V5-K 4×1.5mm² BLACK

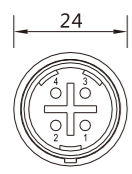

A
4 PIN

Cable color	Signal	PIN#
1 Yellow	U	PIN2
2 Red	V	PIN3
3 Black	W	PIN4
Yellow-Green	PE	PIN1
Metal ring	Shield	Shield terminal

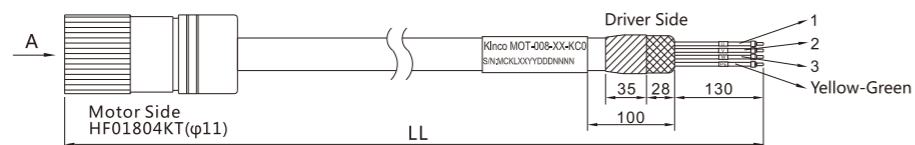

Wiring Diagram for The Power Cable

MOT-008-LL-KC1

Wire Spec. cable 4C×1.5mm²

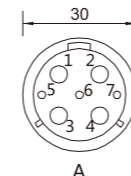

A

Cable color	Signal	PIN#
1 Yellow	U	PIN2
2 Red	V	PIN3
3 Black	W	PIN4
Yellow-Green	PE	PIN1

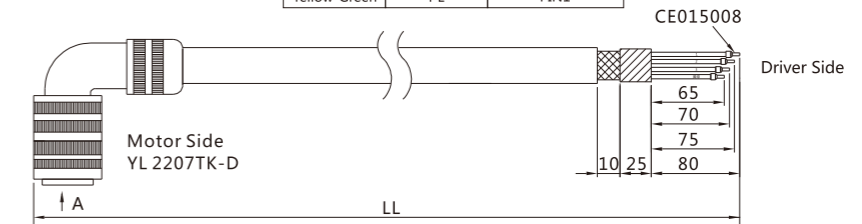

MOT-008-LL-KC2

Power cable O-2395 4C×1.5mm²(30/0.25B)

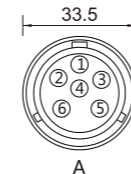

A

Cable color	Signal	YL2406TK-Y
Yellow	U	PIN1
Red	V	PIN2
Black	W	PIN3
Yellow-Green	PE	PIN4

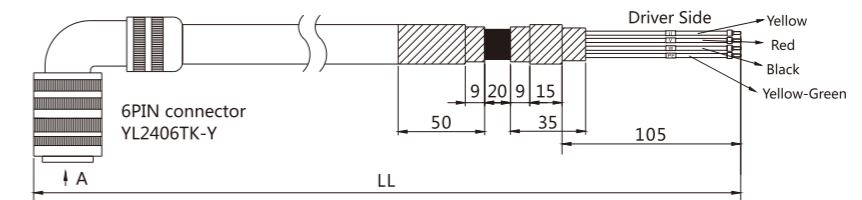

MOT-008-LL-KC2-B

Wire Spec. ECHU RVVYP 4×1.5mm²+2×0.5mm²



A

Cable color	Signal	YL2406TK-Y
Yellow	U	PIN1
Red	V	PIN2
Black	W	PIN3
Yellow-Green	PE	PIN4
Red thin wire	brake+	PIN5
Blue thin wire	brake-	PIN6
Shield terminal	Shield	Metal ring

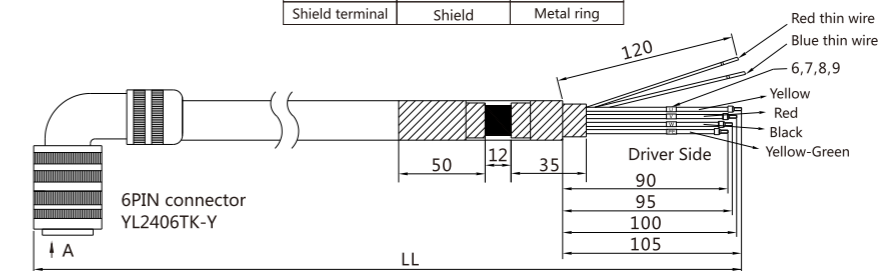

MOT-008-LL-KC4

Wire Spec. UL2586 4×16AWG
The sectional area of 16AWG is 1.318mm²

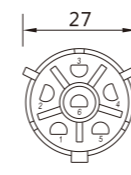

A
6PIN

Cable color	Signal	HFO2106TK
Yellow	U	PIN2
Red	V	PIN3
Black	W	PIN4
Yellow-Green	PE	PIN6

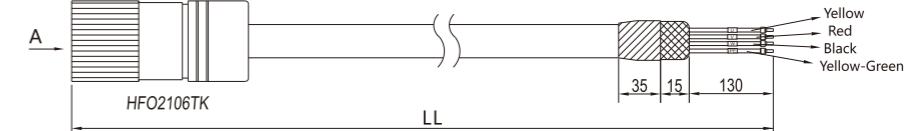

Wiring Diagram for The Power Cable

MOT-008-LL-KC4-B

Wire Spec. 4x1.5mm²+2x0.5mm²

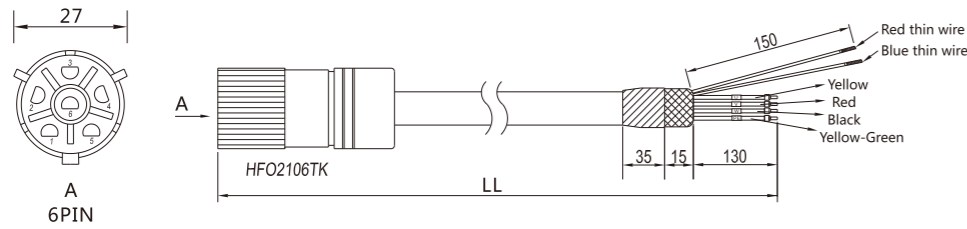

Cable color	Signal	HFO2106TK
Yellow	U	PIN2
Red	V	PIN3
Black	W	PIN4
Yellow-Green	PE	PIN6
Red thin wire	brake+	PIN1
Blue thin wire	brake-	PIN5

MOT-008-LL-KM1

Wire Spec. cable 4Cx1.5mm²

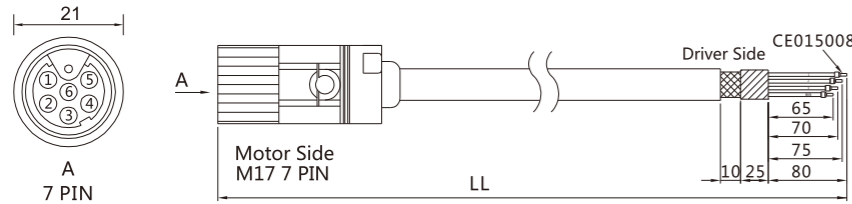

Cable color	Signal	PIN#
1 Yellow	U	PIN1
2 Red	V	PIN2
3 Black	W	PIN3
Yellow-Green	PE	⊥

MOT-015-LL-KC2

Power Cable Cableplus UL2856 4x14AWG(50/0.25T)

The sectional area of 14AWG is 2.075mm²

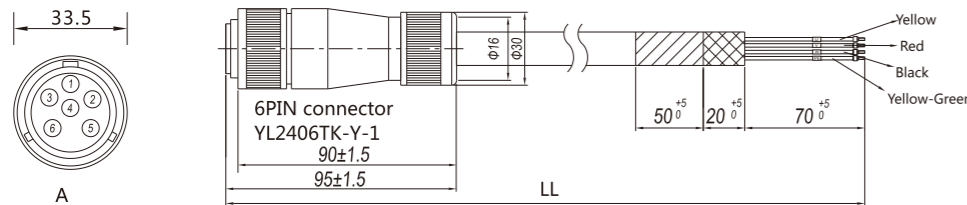

Cable color	Signal	YL2406TK-Y-1
Yellow	U	PIN1
Red	V	PIN2
Black	W	PIN3
Yellow-Green	PE	PIN4
Shield terminal	Shield	Metal ring

MOT-015-LL-KC2-B

Power Cable Cableplus

EKM715734x2.5mm²+2x0.5mm²

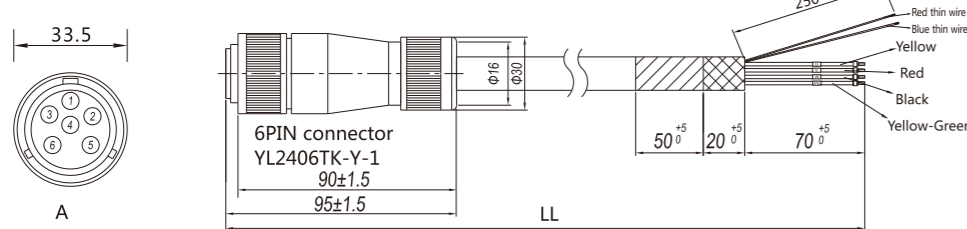

Cable color	Signal	YL2406TK-Y-1
Yellow	U	PIN1
Red	V	PIN2
Black	W	PIN3
Yellow-Green	PE	PIN4
Red thin wire	brake+	PIN5
Blue thin wire	brake-	PIN6
Shield terminal	Shield	Metal ring

Wiring Diagram for The Power Cable & Encoder Cable

MOT-030-LL-KC3

Wire Spec. ECHU RVVYP 4x4mm²

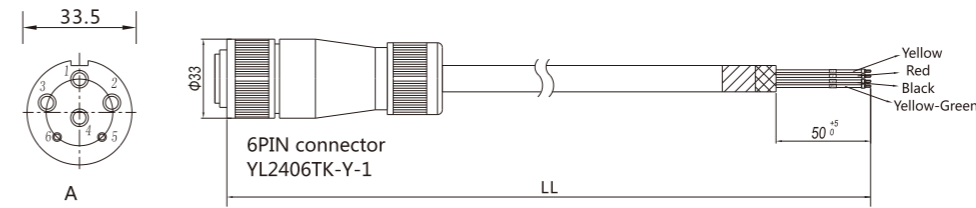

Cable color	Signal	YL2406TK-Y-1
Yellow	U	PIN1
Red	V	PIN2
Green	W	PIN3
Yellow-Green	PE	PIN4
Shield terminal	Shield	Metal ring

Wiring Diagram for The Encoder Cable

ENCCF-LL-FC0

Wire Spec. 1P×24AWG(7/0.20T)+4P×28AWG(7/0.127T)

The sectional area of 24AWG is 0.2047mm²

The sectional area of 28AWG is 0.0804mm²

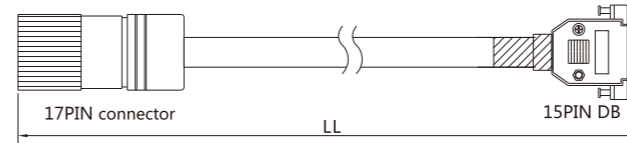

17PIN connector	15PIN DB	Signal	External wire colour	Motor wire colour
PIN1	PIN1	+5V	Red(thick)	Red
PIN3	PIN2	A	Brown	Blue-black
PIN5	PIN3	B	Yellow	Green
PIN14	PIN4	Z	Green	Yellow
PIN2	PIN9	GND	Black(thick)	Black
PIN4	PIN10	/A	Brown-white	Blue
PIN6	PIN11	/B	Yellow-white	Green-black
PIN15	PIN12	/Z	Green-white	Yellow-black
Other pins empty	Other pins empty			
Metal coil	Shell	Shield	Shield	Shield

ENCCA-LL-KC0

Wire Spec. 1P×24AWG(7/0.20T)+7P×28AWG(7/0.127T)

The sectional area of 24AWG is 0.2047mm²

The sectional area of 28AWG is 0.0804mm²

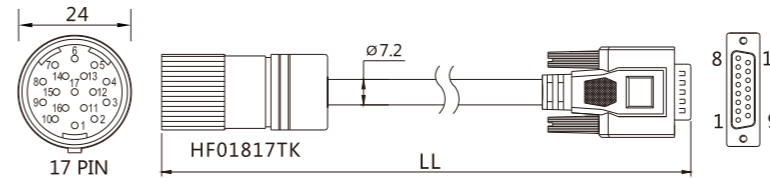

ENCCA-LL-KC1

Wire Spec. 1P×24AWG(7/0.20T)+7P×28AWG(7/0.127T)

The sectional area of 24AWG is 0.2047mm²

The sectional area of 28AWG is 0.0804mm²

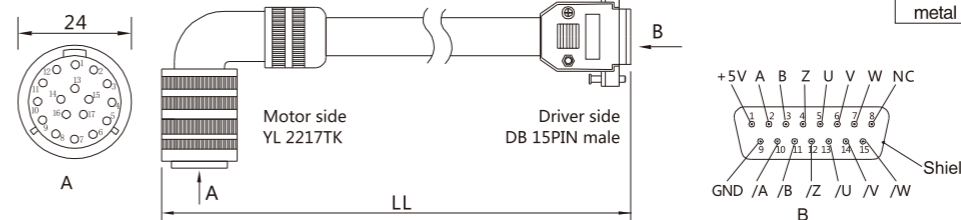

17PIN	15PIN DB	Signal	External wire colour	Motor wire colour
PIN1	PIN1	+5V	Red(thick)	Red
PIN3	PIN2	A	Orange	Blue
PIN5	PIN3	B	Yellow	Green
PIN14	PIN4	Z	Green	Yellow
PIN9	PIN5	U	Brown	Brown
PIN11	PIN6	V	Purple	Gray
PIN16	PIN7	W	Blue	White
PIN2	PIN9	GND	Black(thick)	Black
PIN4	PIN10	/A	Orange-white	Blue-black
PIN6	PIN11	/B	Yellow-white	Green-black
PIN15	PIN12	/Z	Green-white	Yellow-black
PIN10	PIN13	/U	Brown-white	Brown-black
PIN12	PIN14	/V	Purple-white	Gray-black
PIN17	PIN15	/W	Blue-white	White-black
Internal metal ring	DB metal shell	Shield	Shield	Shield

Wiring Diagram for The Encoder Cable

ENCCA-LL-KH

Wire Spec. 1P×24AWG(7/0.20T)+7P×28AWG(7/0.127T)
 The sectional area of 24AWG is 0.2047mm²
 The sectional area of 28AWG is 0.0804mm²

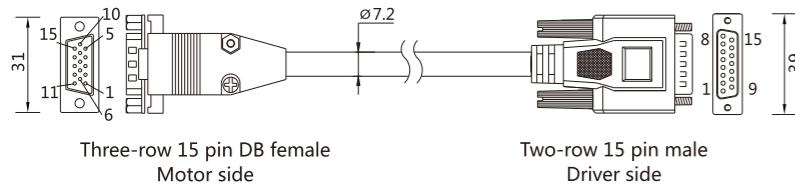

ENCCF-LL-FH

Wire Spec. 1P×24AWG(7/0.20T)+4P×28AWG(7/0.127T)
 The sectional area of 24AWG is 0.2047mm²
 The sectional area of 28AWG is 0.0804mm²

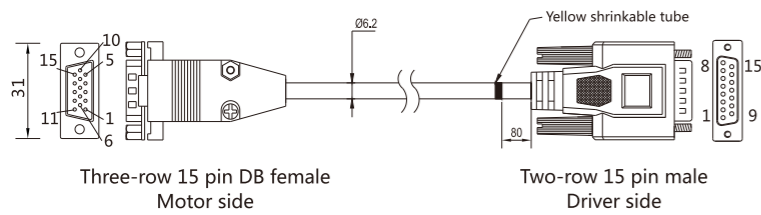

ENCCA-LL-KM1

Wire Spec. 1P×24AWG(7/0.20T)+7P×28AWG(7/0.127T)
 The sectional area of 24AWG is 0.2047mm²
 The sectional area of 28AWG is 0.0804mm²

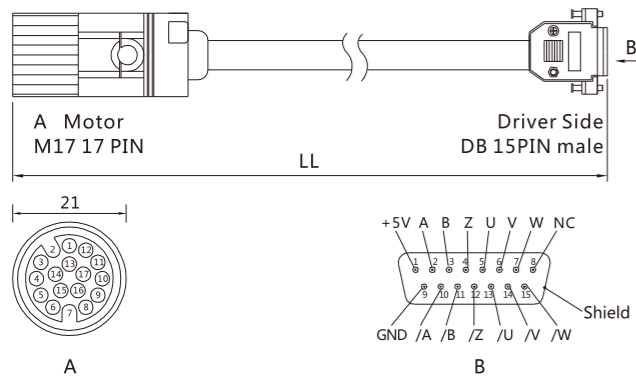

ENCCA-LL-KH				
Three-row 15 pin DB	Two-row 15 pin DB	Signal	External wire color	Motor wire color
PIN1	PIN1	+5V	Red(thick)	Red
PIN8	PIN2	A	Orange	Blue-black
PIN7	PIN3	B	Yellow	Green
PIN6	PIN4	Z	Green	Yellow
PIN4	PIN5	U	Brown	Brown-black
PIN10	PIN6	V	Purple	White-black
PIN9	PIN7	W	Blue	Gray-black
PIN2	PIN9	GND	Black(thick)	Black
PIN13	PIN10	/A	Orange-white	Blue
PIN12	PIN11	/B	Yellow-white	Green-black
PIN11	PIN12	/Z	Green-white	Yellow-black
PIN5	PIN13	/U	Brown-white	Brown
PIN15	PIN14	/V	Purple-white	White
PIN14	PIN15	/W	Blue-white	Gray
PIN3 empty	PIN8 empty			
Metal shell	DB metal shell	Shield	Shield	Metal shell

ENCCF-LL-FH				
Three-row 15 pin DB	Two-row 15 pin DB	Signal	Wire color	Motor wire color
PIN1	PIN1	+5V	Red(thick)	Red
PIN8	PIN2	A	Brown	Blue-black
PIN7	PIN3	B	Yellow	Green
PIN6	PIN4	Z	Green	Yellow
PIN2	PIN9	GND	Black(thick)	Black
PIN13	PIN10	/A	Brown-white	Blue
PIN12	PIN11	/B	Yellow-white	Green-black
PIN11	PIN12	/Z	Green-white	Yellow-black
Other pins empty	Other pins empty			
Shell	Shell	Shield	Shield	Shield

ENCCA-LL-KM1				
17PIN	15PIN DB	Signal	External wire colour	Motor wire colour
PIN1	PIN1	+5V	Red(thick)	Red
PIN3	PIN2	A	Orange	Blue
PIN5	PIN3	B	Yellow	Green
PIN14	PIN4	Z	Green	Yellow
PIN9	PIN5	U	Brown	Brown
PIN11	PIN6	V	Purple	Gray
PIN16	PIN7	W	Blue	White
PIN2	PIN9	GND	Black(thick)	Black
PIN4	PIN10	/A	Orange-white	Blue-black
PIN6	PIN11	/B	Yellow-white	Green-black
PIN15	PIN12	/Z	Green-white	Yellow-black
PIN10	PIN13	/U	Brown-white	Brown-black
PIN12	PIN14	/V	Purple-white	Gray-black
PIN17	PIN15	/W	Blue-white	White-black
Internal metal ring	DB metal shell	Shield	Shield	Shield

Wiring Diagram for The Encoder Cable

ENCCR-LL-FC1

Wire Spec. UL2464 24AWG/1P+28AWG/4P
 The sectional area of 24AWG is 0.2047mm²
 The sectional area of 28AWG is 0.0804mm²

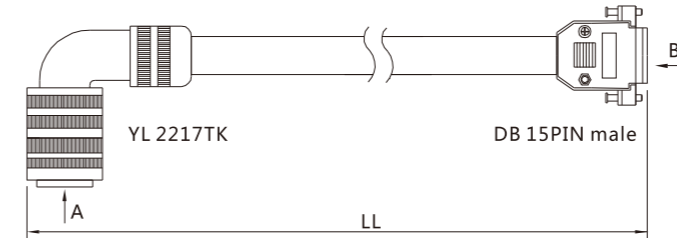

ENCCR-LL-FC1			
YL2217TK	15PIN DB	Signal	Wire color
PIN1	PIN6	ref+	Brown
PIN2	PIN14	ref-	Brown-white
PIN3	PIN2	cos+	Green
PIN4	PIN10	cos-	Green-white
PIN5	PIN3	sin+	Yellow
PIN6	PIN11	sin-	Yellow-white
PIN7	PIN8	KTY+	Blue
PIN8	PIN9	KTY-	Blue-white
Metal ring	Metal shell	Shield	Shield

ENCCG-LL-GU

Wire Spec. 3×2×0.2mm²

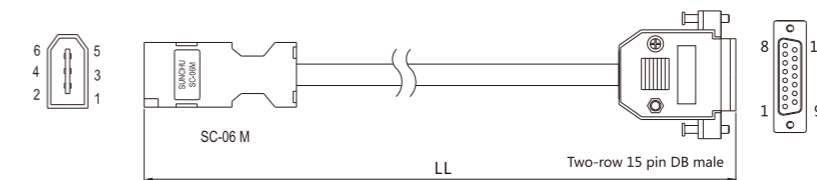

ENCCG-LL-GU			
SC-06F	Wire color	Signal	15PIN DB
PIN1	Red	+5V	PIN1
PIN2	Black	GND	PIN9
PIN5	Yellow	SD	PIN7
PIN6	Green	/SD	PIN15
Shell	Shield	Shield	Shell

ENCCG-(4)-GU-BT

Wire Spec. 3×2×0.2mm²

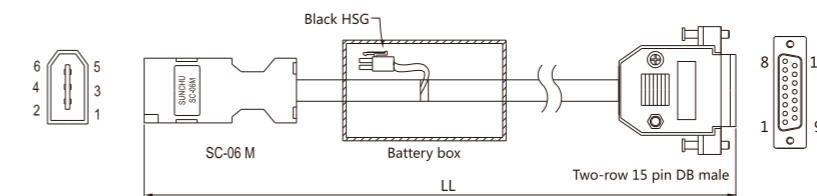

ENCCG-(4)-GU-BT					
SC-06F	Cable color	Black HSG	External wire	Signal	15PIN DB
PIN1	Red			+5V	PIN1
PIN2	Black			GND	PIN9
PIN3	Brown	PIN1	Red	BAT+	
PIN4	Blue	PIN2	Black	BAT-	
PIN5	Yellow			SD	PIN7
PIN6	Green			/SD	PIN15
Shell	Shield			Shield	Shell

ENCDG-LL-GU

Wire Spec. 3×2×0.2mm²

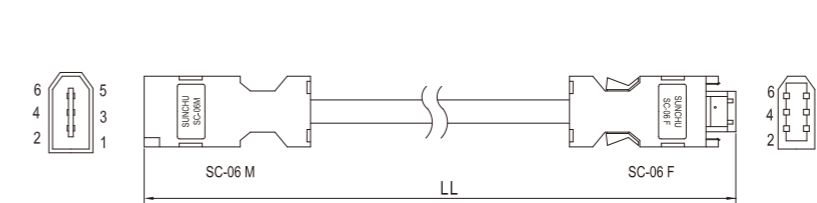

ENCDG-LL-GU		
Wire color	Signal	SC-06
Red	+5V	PIN1
Black	GND	PIN2
Brown	BAT+	PIN3
Blue	BAT-	PIN4
Yellow	SD	PIN5
Green	/SD	PIN6
Shield	Shield	Shell